



**Town of Surfside
Special Town Commission Meeting
AGENDA
June 23, 2020
7 p.m.**

Town Hall Commission Chambers - 9293 Harding Ave, 2nd Floor
Surfside, FL 33154

1. Opening

A. Call to Order

B. Roll Call of Members

C. Mayor and Commission Remarks

1. **Essential Business & Focus** – Commissioner Charles Kesl
2. **Direction and Action on motion to Censure Commissioner Salzhauer** – Commissioner Charles Kesl

2. Resolutions

A. Audio Visual Equipment Upgrades and Extended Maintenance & Support – Guillermo Olmedillo, Town Manager **(Pages 1-63)**

A RESOLUTION OF THE TOWN COMMISSION OF THE TOWN OF SURFSIDE, FLORIDA, APPROVING THE PROPOSALS FOR AUDIO VISUAL AND BROADCASTING EQUIPMENT AND SUPPORT, ZOOM ROOM INTEGRATION, CLOSE CAPTIONING EQUIPMENT AND MAINTENANCE, AND ADDENDUM (COLLECTIVELY, AGREEMENT) WITH AUDIO VISUAL INNOVATIONS, INC.; PROVIDING FOR AUTHORIZATION AND IMPLEMENTATION OF THE AGREEMENT; AUTHORIZING EXPENDITURE OF FUNDS; AND PROVIDING FOR AN EFFECTIVE DATE.

- B. Sand Dollar Key Tot Lot and Waterslide Renovations – Guillermo Olmedillo, Town Manager (Pages 64-88)**

A RESOLUTION OF THE TOWN COMMISSION OF THE TOWN OF SURFSIDE, FLORIDA, APPROVING THE PURCHASE OF WATERSLIDE REPAIR AND MAINTENANCE WORK FROM DALE COOPER LLC D/B/A SAFE SLIDES RESTORATION; FINDING THAT THE PURCHASE IS EXEMPT FROM COMPETITIVE BIDDING PURSUANT TO SECTION 3-13(7)F OF THE TOWN CODE AS A PUBLIC WORKS OR UTILITIES PURCHASE FOR TOWN FACILITY MAINTENANCE WORK; AUTHORIZING THE TOWN MANAGER TO ENTER INTO A PURCHASE ORDER FOR SUCH PURCHASE; PROVIDING FOR IMPLEMENTATION; AND PROVIDING FOR AN EFFECTIVE DATE.

- C. Youth Sports Program Coaches (Cyclone Soccer) - Guillermo Olmedillo, Town Manager (Pages 89-104)**

TOWN OF SURFSIDE, FLORIDA, APPROVING AGREEMENTS WITH CYCLONE SOCCER MIAMI, INC. FOR THE TOWN'S YOUTH INSTRUCTIONAL SOCCER AND COMPETITIVE SOCCER PROGRAMS; FINDING THAT THE SERVICES ARE EXEMPT FROM COMPETITIVE PROCUREMENT PURSUANT TO SECTION 3-13(2) OF THE TOWN CODE; PROVIDING FOR IMPLEMENTATION; AND PROVIDING FOR AN EFFECTIVE DATE.

- D. Town's Zoning Code Review and Support - Guillermo Olmedillo, Town Manager (Pages 105-111)**

A RESOLUTION OF THE TOWN COMMISSION OF THE TOWN OF SURFSIDE, FLORIDA, APPROVING THE ENGAGEMENT OF CWB ASSOCIATES (C. WESLEY BLACKMAN, AICP) FOR PLANNING CONSULTING SERVICES FOR SUPPORT IN THE REVIEW OF THE TOWN'S ZONING CODE; FINDING THAT THE SERVICES ARE EXEMPT FROM COMPETITIVE PROCUREMENT PURSUANT TO SECTION 3-13(2) OF THE TOWN CODE; AUTHORIZING THE TOWN MANAGER TO EXECUTE A PROFESSIONAL SERVICES AGREEMENT FOR THE SERVICES; PROVIDING FOR IMPLEMENTATION; AND PROVIDING FOR AN EFFECTIVE DATE.

- E. Black Lives Matter – Mayor Charles W. Burkett (Pages 112-117)**

A RESOLUTION OF THE MAYOR AND TOWN COMMISSION OF THE TOWN OF SURFSIDE, FLORIDA, CONDEMNING THE ALLEDGED CRIMINAL ACTIONS OF THE MINNEAPOLIC POLICE OFFICERS INVOLVED IN THE DEATH OF GEORGE FLOYD, EXTENDING CONDOLENCES TO THE FAMILY OF GEORGE FLOYD FOR THEIR

LOSS, AND SUPPORTING THE FLOYD FAMILY BY WAY OF A CALL FOR TRUE SOCIAL JUSTICE, RACIAL EQUALITY AND BY WAY OF OTHER INITIATIVES OUTLINED HEREIN; PROVIDING FOR TRANSMITTAL; AND PROVIDING FOR AN EFFECTIVE DATE.

F. Black Lives Matter – Commissioner Eliana Salzhauer (Pages 118-120)

A RESOLUTION OF THE MAYOR AND TOWN COMMISSION OF THE TOWN OF SURFSIDE, FLORIDA, IN SUPPORT OF THE BLACK LIVES MATTER MOVEMENT AND THE TOWN OF SURFSIDE'S COMMITMENT TO RACIAL EQUALITY; PROVIDING FOR IMPLEMENTATION; PROVIDING FOR TRANSMITTAL; AND PROVIDING FOR AN EFFECTIVE DATE

3. Public Comments from Residents (Set for approximately 8:15 p.m.)

Public comments for subjects or items not on the agenda. Public comment on agenda items will be allowed when agenda item is discussed by the Commission.

4. Mayor, Commission and Staff Communications

- A. COVID-19 Task Force Update – Mayor, Vice Mayor and Members of the Town Commission**
- B. Brightview Agreement (FKA Luke's Landscape) Report and Follow up– Staff Report – Guillermo Olmedillo, Town Manager (Page 121)**
- C. Reconsideration of the Installation of Berms on 92nd Street - Vice Mayor Tina Paul**
- D. Miami Christmas Lights – Guillermo Olmedillo, Town Manager (Pages 122-123)**
- E. Staffing Hiring Freeze – Commissioner Eliana Salzhauer (Page 124)**
- F. New Zoning Code- Procedural and Notice Requirements – Mayor Charles W. Burkett**
- G. 92nd St Beach-end Improvements - Mayor Charles W. Burkett (Pages 125-141)**
- H. Rope Fencing & Posts-Beachwalk/Hardpack - Mayor Charles W. Burkett**
- I. Develop Capital Improvement Plan (CIP) - Mayor Charles W. Burkett**
- J. 10 Year Water Supply Plan - Mayor Charles W. Burkett**
- K. Various Parks & Recreation Related Events and Initiatives – Mayor Charles W. Burkett**
- L. Building Department File Digitization – Mayor Charles W. Burkett**
- M. Pinzur Communication – Mayor Charles W. Burkett (Pages 142-148)**
- N. Preservation of Eden Project located at 9300 Collins Avenue - Mayor Charles W. Burkett**
- O. Speeding on Collins and Harding - Mayor Charles W. Burkett**
- P. Amending Town Code Section 2-205 Conduct of Meetings; Agenda – Mayor Charles W. Burkett (Pages 149-164)**

- Q. Homeless Contribution by the Town of Surfside of \$100,000 - Mayor Charles W. Burkett**
- R. Free (hassle-free) downtown parking for residents - Mayor Charles W. Burkett**
- S. Charter Amendments to affirm the limit of pay for elected officials to a maximum of \$1 per year, term limits for elected officials of 3 consecutive terms, or any part thereof, for both Mayor & Commissioners, a prohibition on the sale or leasing of any Town property without a referendum & a prohibition against any loan or borrowing of any type, which would put the Town into debt for more than 10% of its annual property tax revenue and which could not be fully amortized within a total of 5 years and restore development protections in the charter- Mayor Charles W. Burkett (Pages 165-167)**
- T. Records Retention Policy – Mayor Charles W. Burkett**
- U. Regulation of Short-Term Rentals – Mayor Charles W. Burkett (Page 168)**
- V. Star Cleaning service (Street Sweeping) – Mayor Charles W. Burkett (Pages 169-181)**
- W. S.M.A.R.T Goals, Quality Control & Quality Assurance – Commissioner Charles Kesl**
- X. Design Review Board Discussion – Staff Report – Guillermo Olmedillo, Town Manager (Pages 182-200)**
- Y. Weiss Serota Contract Follow up – Staff Report – Guillermo Olmedillo, Town Manager (Pages 201-207)**
- Z. Town Pension Benefits for Non-Public Safety Employees – Mayor Charles W. Burkett (Pages 208-280)**
- AA. Additional lighting in the residential area – Staff Report – Guillermo Olmedillo, Town Manager (Pages 281-309)**
- BB. Construction Guidelines for Hurricane Season – Commissioner Nelly Velasquez**
- CC. Lowering of Property Taxes and Water Bills – Staff Report – Guillermo Olmedillo, Town Manager (Pages 310-347)**
- DD. CGA Contract Follow Up – Staff Report – Guillermo Olmedillo, Town Manager (Pages 348-355)**
- EE. Discussion Regarding Appointments to Committees and Boards – Sandra N. McCready, Town Clerk**
- FF. Downtown Lighting RFP – Mayor Charles W. Burkett**
- GG. Undergrounding power lines – Staff Report – Guillermo Olmedillo, Town Manager (Pages 356-362)**
- HH. Dog Park – Mayor Charles W. Burkett (Pages 363-364)**
- II. FPL Solar Together - Vice Mayor Tina Paul (Pages 365-368)**

- JJ. **Climate Environmental Collective - Revised - Vice Mayor Tina Paul**
(Pages 369-370)
- KK. **Interest Free Loans to Surfside Builders Granted by Former Mayor and Commission – Mayor Charles W. Burkett** **(Pages 371-382)**
- LL. **How our Zoning Protections Against Over-Development Were Guttled -**
Mayor Charles W. Burkett
- MM. **Amending Town Code Section 2-233 to Include Non-for-Profit – Mayor**
Charles W. Burkett
- NN. **Amending Town Code Section 2-237 Business Relationships –**
Commissioner Eliana Salzhauer
- OO. **Speeding & Stop Sign Running - Commissioner Eliana Salzhauer**
- PP. **Surfside Point Lake Subaqueous WM Crossing - Bid Documents –**
Guillermo Olmedillo, Town Manager **(Pages 383-437)**
- QQ. **Beachwalk Trimming- Staff Report – Guillermo Olmedillo, Town Manager**
(Page 438)
- RR. **Pool Deck Lighting for Extended Winter Hours- Staff Report – Guillermo**
Olmedillo, Town Manager **(Page 439)**
- SS. **Community Center Second Floor – Staff Report - Guillermo Olmedillo,**
Town Manager **(Page 440)**
- TT. **Streamline Town Staffing – Commissioner Eliana Salzhauer** **(Pages 441-**
442)
- UU. **Repeal of Ordinance No. 17-1662 Beach Furniture – Mayor Charles W.**
Burkett **(Pages 443-450)**
- VV. **Replace Ordinance No. 17-1662 Beach Furniture with New Beach**
Furniture Ordinance – Commissioner Eliana Salzhauer
- WW. **Designated (Painted) Walking Areas in the Residential District- Staff**
Report – Guillermo Olmedillo, Town Manager **(Pages 451-453)**
- XX. **Procurement Expertise – Commissioner Eliana Salzhauer**
- YY. **Take Home Vehicles - Commissioner Eliana Salzhauer**
- ZZ. **Recent and Significant Increase in Boat, Paddleboard and Kayak Use on**
Point Lake – Mayor Charles W. Burkett
- AAA. **Comparison of 2006 Code to 2020 Code – Staff Report – Guillermo**
Olmedillo, Town Manager **(Pages 454-458)**
- BBB. **Stormwater Masterplan - Staff Report – Guillermo Olmedillo, Town**
Manager **(Pages 459-460)**
- CCC. **Big Belly Trash Contract Termination Replacement and Replacement**
Bins for Trash and Recycling Receptacles Throughout Town -
Guillermo Olmedillo, Town Manager **(Pages 461-498)**
- DDD. **Beach Preservation Initiatives (“Carry On-Carry Off”/ Clean-Ups/
Chair- Free Safe Space Behind Community Center) - Staff Report –**
Guillermo Olmedillo, Town Manager

- EEE. Securing Power Infrastructure: Timely Action Plan for Hurricane Season through accountability now by FPL, ATT and Atlantic Broadband – Staff Report – Guillermo Olmedillo, Town Manager**
- FFF.. Amendment to the Tourist Board Ordinance – Commissioner Nelly Velasquez**

Thirty (30) Day Staff Report – Items from March 24, 2020 Special Town Commission Meetings – COMPLETED

Thirty (30) Day Staff Report – Items from March 31, 2020 Special Town Commission Meetings – COMPLETED

Thirty (30) Day Staff Report – Items from April 7, 2020 Special Town Commission Meetings – COMPLETED

Thirty (30) Day Staff Report – Items from April 16, 2020 Regular Town Commission Meetings – COMPLETED

Thirty (30) Day Staff Report – Items from April 21, 2020 Regular Town Commission Meetings - COMPLETED

Thirty (30) Day Staff Report – Items from April 28, 2020 Regular Town Commission Meetings - COMPLETED

Items Completed or Removed from Previous Agendas

- A. Resolution Adopting an Amended Resiliency Reserve Policy Revision**
- B. Resolution Approving the March 17, 2020 Town of Surfside Municipal Election**
- C. Resolution Abolishing the Sustainability and Resiliency Committee**
- D. Resolution Amending the Downtown Vision Advisory Committee**
- E. Resolution Reauthorizing the Parks and Recreation Committee**
- F. “Flash Your Lights” - Commissioner Eliana Salzhauer**
- G. Mandatory Face Mask in the Town of Surfside – Commissioner Nelly Velasquez**
- H. Bandanas for Town Residents – Commissioner Eliana Salzhauer**
- I. Commission Meeting Starting Time at 6:00pm – Mayor Charles W. Burkett**

- J. Discussion Regarding Assistant Town Manager position and Action** - Commissioner Nelly Velasquez
- K. Photovoltaic RFP** - Mayor Charles W. Burkett
- L. Facilities Review** - Mayor Charles W. Burkett
- M. Kayak Launch** - Mayor Charles W. Burkett
- N. Jacober Contract** – Mayor Charles W. Burkett
- O. Zambelli Fireworks Manufacturing** - Mayor Charles W. Burkett
- P. Small Business Survival Grant** - Vice Mayor Tina Paul
- Q. Review of Amendment No. 2 to Update No. 5 Town of Surfside Emergency Measures** – Vice Mayor Tina Paul
- R. Downtown Surfside Sidewalk Beautification - Plans and Studies** - Mayor Charles W. Burkett [*Downtown Vision Advisory Committee to discuss*]
- S. Sidewalk on N 95th St between Abbott and Byron** - Mayor Charles W. Burkett
- T. Beach Raking** – Mayor Charles W. Burkett
- U. Community Digital Signs** – Mayor Charles W. Burkett
- V. Government Academy** - Mayor Charles W. Burkett
- W. Various Tourism Related Events, Initiatives, and Destination Marketing** - Mayor Charles W. Burkett
- X. Classification and Compensation Study** – Mayor Charles W. Burkett
- Y. Flooding/Drainage Improvements** – Guillermo Olmedillo, Town Manager
- Z. Abbott Avenue Drainage Improvements** – Commissioner Nelly Velasquez
- AA. Downtown Surfside Sidewalk Beautification - Plans and Studies** - Mayor Charles W. Burkett – *Referred to DVAC*
- BB. Police Body-Worn Camera System** – Commissioner Nelly Velasquez
- CC. Care ACT Fund** – Guillermo Olmedillo, Town Manager
- DD. FY 2020 Budget Amendment** – Guillermo Olmedillo, Town Manager
- EE. Purchase of Additional Sewer Pump** – Guillermo Olmedillo, Town Manager
- FF. Planning and Zoning Board Membership Requirements Ordinance** – Guillermo Olmedillo, Town Manager
- GG. Tourist Board Membership Requirement Ordinances**– Guillermo Olmedillo, Town Manager
- HH. Resolution Renaming the Town’s Higher Education Scholarships to be called the “Arya Gray Memorial Higher Education Scholarship”** – Commissioner Eliana Salzhauer
- II. Interlocal Shuttle System Report Update** – Guillermo Olmedillo, Town Manager

5. Adjournment

Respectfully submitted,



Guillermo Olmedillo
Town Manager

THIS MEETING IS OPEN TO THE PUBLIC. IN ACCORDANCE WITH THE AMERICANS WITH DISABILITIES ACT OF 1990, ALL PERSONS THAT ARE DISABLED; WHO NEED SPECIAL ACCOMMODATIONS TO PARTICIPATE IN THIS MEETING BECAUSE OF THAT DISABILITY SHOULD CONTACT THE OFFICE OF THE TOWN CLERK AT 305-861-4863 EXT. 226 NO LATER THAN FOUR DAYS PRIOR TO SUCH PROCEEDING.

IN ACCORDANCE WITH THE PROVISIONS OF SECTION 286.0105, FLORIDA STATUTES, ANYONE WISHING TO APPEAL ANY DECISION MADE BY THE TOWN OF SURFSIDE COMMISSION, WITH RESPECT TO ANY MATTER CONSIDERED AT THIS MEETING OR HEARING, WILL NEED A RECORD OF THE PROCEEDINGS AND FOR SUCH PURPOSE, MAY NEED TO ENSURE THAT A VERBATIM RECORD OF THE PROCEEDINGS IS MADE WHICH RECORD SHALL INCLUDE THE TESTIMONY AND EVIDENCE UPON WHICH THE APPEAL IS TO BE BASED.

AGENDA ITEMS MAY BE VIEWED AT THE OFFICE OF THE TOWN CLERK, TOWN OF SURFSIDE TOWN HALL, 9293 HARDING AVENUE. ANYONE WISHING TO OBTAIN A COPY OF ANY AGENDA ITEM SHOULD CONTACT THE TOWN CLERK AT 305-861-4863. A COMPLETE AGENDA PACKET IS ALSO AVAILABLE ON THE TOWN WEBSITE AT www.townofsurfsidefl.gov.

TWO OR MORE MEMBERS OF OTHER TOWN BOARDS MAY ATTEND THIS MEETING.

THESE MEETINGS MAY BE CONDUCTED BY MEANS OF OR IN CONJUNCTION WITH COMMUNICATIONS MEDIA TECHNOLOGY, SPECIFICALLY, A TELEPHONE CONFERENCE CALL. THE LOCATION 9293 HARDING AVENUE, SURFSIDE, FL 33154, WHICH IS OPEN TO THE PUBLIC, SHALL SERVE AS AN ACCESS POINT FOR SUCH COMMUNICATION.



MEMORANDUM

ITEM NO. 2A

To: Honorable Mayor, Vice-Mayor and Members of the Town Commission

From: Guillermo Olmedillo, Town Manager

Date: June 23, 2020

Subject: Audio Visual Equipment Upgrades and Extended Maintenance & Support

Audio Visual Innovations (AVI-SPL) is the Town's current vendor for the Commission Chambers audio-visual system. There are three supplemental agreements for which Town Administration is seeking approval to execute.

1. Extension of Annual Maintenance & Support agreement
 - a. On March 12, 2019, the Commission approved the Town to enter into an agreement with AVI-SPL to provide upgraded audio visual and broadcast equipment and installation services.
 - b. The initial maintenance & support service needed to be extended and the Town Administration is seeking approval for a five (5) year extension through September 30, 2025 for maintenance & support agreement for a total one-time cost of \$5,177.84.
2. Zoom Integration with Commission Chambers
 - a. Additional service to allow for hybrid in person/ virtual meetings.
 - b. This will allow for residents to continue participation via Zoom when in person Commission meeting re-start as expected in July 2020.
 - c. Residents would be able use the chat function to communicate and ask to speak on an item. Their screen would be shown on the chamber's projection wall. Commissioners, if they choose, would be able to access the chat via their previously provided computer equipment/device.
 - d. Town Administration is seeking approval for a one-time cost of \$8,334.10 and one year of support at a cost of \$1,164.00 per year.

3. Closed Captioning System agreement

- a. In order to meet the accessibility requirements mandated by the Americans with Disabilities Act, and the Federal Communication Commission (FCC) mandates for closed captioning on online video, the Town must invest in a closed captioning solution for both Channel 663 and the online video stream for all Town meetings.
- b. On February 26, 2019, the Commission approved the Town to enter into an agreement with AVI-SPL to provide the Closed Captioning System equipment and installation services.
- c. Since that time, the Town's Information Technology department has worked with AVI-SPI to test various systems to find the best solution.
- d. The Town Administration is seeking approval for a one-time cost of \$50,319.23 (includes first year of hardware and software maintenance support) and an additional three (3) year support at a cost of \$8,905.92 per year.

These services are either budgeted in the current FY 20 budget or can be covered by savings in other areas of the Finance/Information Technology budget. There is no need for a budget amendment. Town Administration recommends execution of the agreements.

Reviewed by: LA

Prepared by: JG

Supplemental Information: Summary of Agreement Costs

Existing provider: Audio Visual Innovation, Inc. (AVI-SPI)

Proposal #1

Service: Broadcasting hardware & software maintenance and support
Request: Extend annual service support for existing equipment through 9/30/25)

One time cost: \$5,177.84

Proposal #2

Service: Zoom Integration with Commission Chambers
Request: Additional service to allow for hybrid in person/ virtual meetings

One time cost: \$8,334.10
Annual Support: \$1,164.00

Proposal #3

Service: Closed Captioning
Request: Complete purchase for closed captioning of broadcasting

One time cost: \$50,319.23
Annual Support: \$8,905.92

*same rate for 3 years

RESOLUTION NO. _____

A RESOLUTION OF THE TOWN COMMISSION OF THE TOWN OF SURFSIDE, FLORIDA, APPROVING THE PROPOSALS FOR AUDIO VISUAL AND BROADCASTING EQUIPMENT AND SUPPORT, ZOOM ROOM INTEGRATION, CLOSE CAPTIONING EQUIPMENT AND MAINTENANCE, AND ADDENDUM (COLLECTIVELY, AGREEMENT) WITH AUDIO VISUAL INNOVATIONS, INC.; PROVIDING FOR AUTHORIZATION AND IMPLEMENTATION OF THE AGREEMENT; AUTHORIZING EXPENDITURE OF FUNDS; AND PROVIDING FOR AN EFFECTIVE DATE.

WHEREAS, the Town of Surfside (“Town”) operates a public broadcasting channel to air Commission meetings and other public meetings and information of the Town (“System”); and

WHEREAS, on March 12, 2019, the Town entered into an agreement for audio visual and broadcasting equipment and installation services for the System with Audio Visual Innovations, Inc., a wholly owned subsidiary of AVI-SPL, Inc. (“AVI-SPL”); and

WHEREAS, AVI-SPL has agreed to provide the Town with certain equipment and support services necessary to operate and enhance the Town’s System, including: (1) audio visual and broadcast equipment and support, (2) zoom integration with the Commission Chambers, and (3) close captioning equipment and maintenance (“Services”); and

WHEREAS, the Town and AVI-SPL desire to enter into an agreement for the Services based on the following proposals: (i) Audio Visual and Broadcasting Equipment and Support, attached hereto as Exhibit “A”; (ii) Zoom Integration with the Commission Chambers, attached hereto as Exhibit “B”; (iii) Close Captioning Equipment and Maintenance, attached hereto as Exhibit “C”; and (iv) Addendum to Agreement, attached hereto as Exhibit “D” (collectively, the “Agreement”); and

WHEREAS, the Town desires to enter into the Agreement, substantially in the form attached hereto as Exhibits “A,” ”B,” “C,” and “D,” and finds that the Agreement is in the best interest and welfare of the Town.

NOW THEREFORE, BE IT RESOLVED BY THE TOWN COMMISSION OF THE TOWN OF SURFSIDE, FLORIDA AS FOLLOWS:

Section 1. Recitals. That the above and foregoing recitals are true and correct and are hereby incorporated by reference.

Section 2. Approval and Authorization. The Agreement, substantially in the form attached hereto as Exhibits “A,” “B,” “C,” and “D,” is approved, subject to such changes as may

be acceptable to the Town Manager and the Town Attorney as to form and legality. The Town Commission authorizes the Town Manager to execute the Agreement on behalf of the Town.

Section 3. Implementation. The Town Manager is authorized to take any and all action necessary to implement the purposes of this Resolution and the Agreement.

Section 4. Authorization to Expend Funds. The Town Manager is authorized to expend (i) \$5,177.84 for Audio Visual and Broadcasting Equipment and Support, in accordance with Exhibit "A"; (ii) \$9,498.10 for Zoom Integration with the Commission Chambers, in accordance with Exhibit "B"; and (iii) \$77,036.99 for Close Captioning Equipment and Maintenance, in accordance with Exhibit "C."

Section 5. Effective Date. This Resolution will become effective upon adoption.

PASSED AND ADOPTED this 23rd day of June, 2020.

FINAL VOTE ON ADOPTION:

Commissioner Charles Kesl	_____
Commissioner Eliana R. Salzhauer	_____
Commissioner Nelly Velasquez	_____
Vice Mayor Tina Paul	_____
Mayor Charles W. Burkett	_____

Charles W. Burkett, Mayor

ATTEST:

Sandra Novoa, MMC
Town Clerk

**APPROVED AS TO FORM AND LEGALITY FOR THE USE
AND BENEFIT OF THE TOWN OF SURFSIDE ONLY:**

Weiss Serota Helfman Cole & Bierman, P.L.
Town Attorney

Service Solution Proposal For

Town of Surfside

Jose Feliz

Current Contract Expiration: 5/31/2020

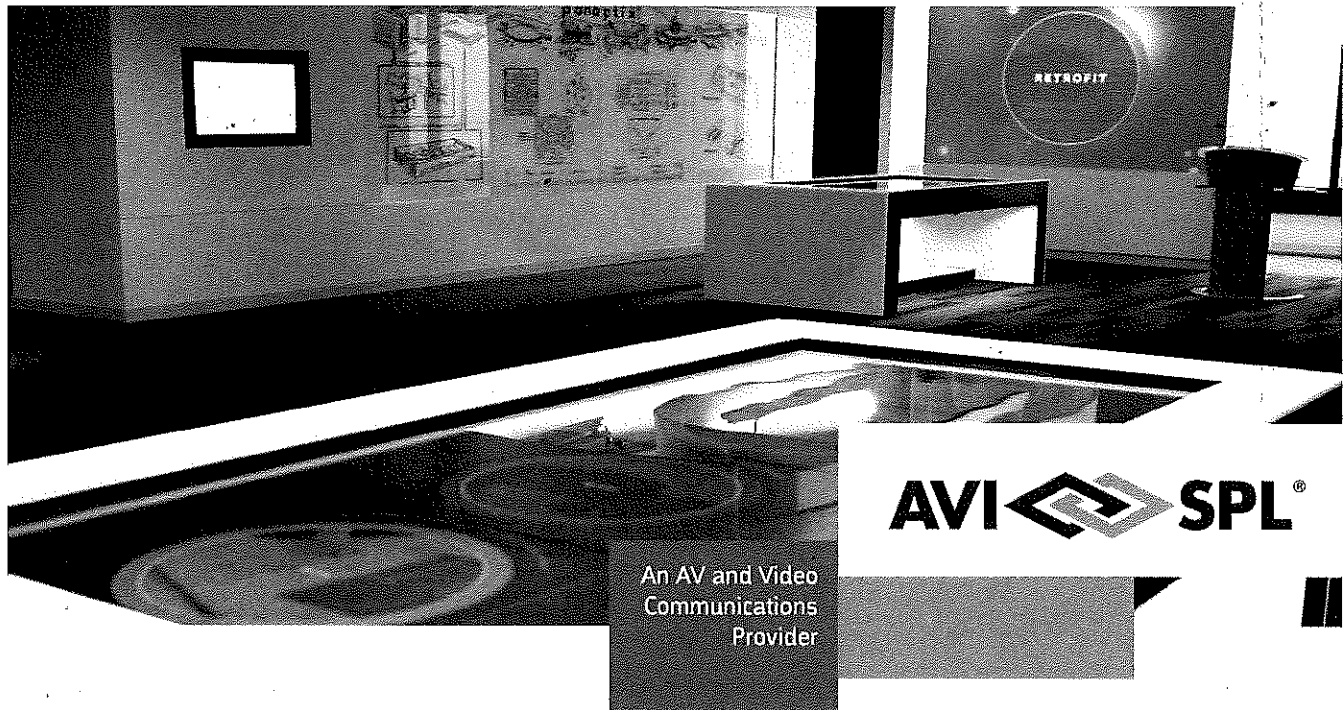

An AV and Video
Communications
Provider

AVI  SPL®

AVI  SPL

Audio Visual Innovations, Inc.
A wholly owned subsidiary of AVI-SPL, Inc.
www.avispl.com

Prepared By: Stacey Thompson
Stacey.Thompson@avispl.com
(813) 884-7168 ext. 2243

Proposal No: 321748 - B
Date: 5/29/2020

Executive Summary

We would like to thank you for considering AVI-SPL for all your service needs.

The team at AVI-SPL is passionate about service delivery and transformation and is focused on delivering the best user experiences. We take pride in the idea of being 100% accountable to our clients for the services we deliver, and we do not take this responsibility lightly.

In today's Audio Visual and Unified Communications environments, where multiple manufacturers are used throughout an organization, where employees and teams are dispersed, customers are now requiring that technology is used effectively, providing business intelligence, so that they can make data driven decisions about their real estate footprint. For example, do they need local open spaces, huddle spaces, 12-person conference rooms? How do they bring their global workforce together, driving home the message of a corporate culture and single unified organization? And how do they enable better business outcomes after the technology investment.

With the amount of technology available today, fragmentation is inevitable. We see non-standard deployments globally or multiple standards deployed, but we cannot treat them as fragmented. We need to accommodate all of users and all of their collaboration.

And lastly, companies do not look at only reducing cost, but they have to take into account innovation, continuous service improvement, all with a focus on the people. After all, it's the people using these technologies, and those people come with all levels of technical capability, comfort, and desired outcomes. And as the newer generations come into our organizations, they want access to different technologies, and they want them to work immediately and easily.

Our response to our customers is becoming a long-term partner and trusted advisor, one that helps you navigate the collaboration landscape and associated workplace transformation to achieve your business objectives.

Key principles that guide our relationship:

- Minimising risk of transition
- Fully understanding your user needs and business objectives
- Maximising long term business benefits
- Improving user experiences

We achieve this with a fully consultative approach to service development and delivery. Underpinning this is our best of breed service capability, whether this is the support offered by our Global Service Operations Centres, the global footprint of our Field Technicians or the unique capabilities of our own User Experience Management Application, Symphony. This is enhanced by our long standing and unrivalled capability, reach and skills in AV and UC integration. These skills will enable you to entrust the full user experience to a single partner. A partner who can bring together the best skills in AV design, deployment and support, as well as video collaboration and integration with 3rd parties into a seamless end to end experience.

AVI-SPL is not a traditional AV Integrator, a manufacturer or a simple supplier. We are your trusted global partner that will design, deploy, manage, and support the systems and environments that empower meaningful communication and collaboration.

Audio Visual Innovations Inc. and Signal Perfection Ltd are wholly owned subsidiaries of AVI-SPL, Inc. This Entire Document and all information presented by any subsidiary are the property of AVI-SPL Inc. Proprietary information provided to potential customers, clients or agents is for the sole purpose of demonstrating solutions delivery capabilities and shall be held in confidence. These Materials may not be copied, distributed or disclosed in any way without the sole written permission of an authorized representative of AVI-SPL. © Copyright AVI-SPL. All Rights Reserved

Global Support Offering Overview

AVI-SPL’s Global Support offerings provide world class services designed to help you achieve the most uptime and the best Return on Investment (ROI) from your technology investment. We utilize our 40 years of experience with 700+ manufacturer technologies to become the service partner you can count on.

	Essential (T&M)	Enhanced	Elite
Unlimited Remote Help Desk, 24x7		●	●
Unlimited Onsite Support, 8x5			●
In Manufacturer-Warranty Hardware Support	●	●	●

Support Services are provided on a per-room or per-project basis.

Essential (Time & Materials)

Full suite of Global Support offerings available in a noncontract form, all billable at standard AVI-SPL rates (See rate table).

Billable Offering Examples:

- * Remote Help Desk, 24x7x365
- * Specialist Remote Support
- * Onsite Technical Dispatch
- * Parts Repair and Replacement

Enhanced

- Offers unlimited remote help desk support – available 24x7x365.
- Facilitates the repair or replacement of manufacturer programs for applicable hardware.
- Access to software updates and upgrades for hardware covered by manufacturer program.
- Use of online incident reporting tool for easy ticket awareness.
- Eligibility for discounted hourly rates when other Global Support services not included in the Enhanced offering are requested.

Elite

- Offers unlimited onsite technical dispatch.
- Offers unlimited remote help desk support – available 24x7x365.
- Facilitates and performs the repair or replacement programs of manufacturer programs for applicable hardware.
- Access to software updates and upgrades for manufacturer program covered hardware.
- Insight into an online incident reporting tool for easy ticket awareness.
- Eligibility for discounted hourly rates when other Global Support services not included in the Elite offering are requested

Plus Options are available at an additional cost.

Our Global Support Plus Options are additions to the Global Support, customized to your unique environment. Plus Options allow us to take on more of the risk associated with aging equipment, help prevent unexpected expenses, and provide an accelerated onsite response time to get spaces up and running. Add one or multiple options to enable the flexibility needed.

Extended Hardware Warranty

Corrective Maintenance Visit

Enhanced Onsite Response: 4 Hour or Next Business Day*

Loaner Equipment

Preventative Maintenance Visit

Consumable Replacement

Extended Hardware Warranty

We cover repair or replacement cost of malfunctioning equipment. Unforeseen expenses drop significantly as we assume the risk of replacement parts of aging equipment.

*Owner Furnished Equipment not Included

Corrective Maintenance Visit

Onsite maintenance visits that can be purchased up-front and scheduled after a fault has been found to resolve a hardware or software issue and bring the room back to operating specifications.

Enhanced Onsite Response

Optional Next Business Day or 4 Hour onsite response (each purchased separately) provide the fastest response possible to keep mission critical situations from escalating.

*Not available in all areas. Subject to AVI-SPL approval

Loaner Equipment

We reduce down time by keeping rooms fully functional while a final repair is executed. We provide a functionally equivalent piece of equipment.

*Not available in all areas. Subject to AVI-SPL approval

Preventative Maintenance Check

Discover a potential issue before a meeting. Onsite visits that work around scheduled use of space to ensure equipment is kept in optimal operating conditions. Onsite technicians complete a standard checklist, and make recommendations to enhance reliability, features, and security.

Consumable Replacement

Proper maintenance is essential to ensuring equipment reaches its maximum lifespan. Mitigate unknown expenses by including high-volume points of failure (examples include: lamps, bulbs, filters, fuses, batteries).

*Not available in all areas. Subject to AVI-SPL approval

* 4 hour onsite response not available in all areas

Global Support Elite Service Description

Global Support - Elite

Our Elite support offering provides, at discounted billable rates, remote technical phone support services, facilitation of manufacturer repair or replacement programs, access to manufacturer published software updates and upgrades for covered assets, and unlimited Onsite Field Technician dispatch. Our Elite support also includes access to an online portal for incident reporting and annual business reviews. Remote technical phone support services are available 24x7x365.

- Unlimited onsite field technician dispatch – Monday - Friday 8AM to 5PM*
- Offers unlimited remote help desk support – available 24x7x365.
- Facilitates the repair or replacement programs of manufacturer programs for applicable hardware.
- Access to software updates and upgrades for hardware covered by manufacturer program.
- Use of online incident reporting tool for easy ticket awareness and annual business reviews.
- Eligibility for discounted hourly rates for other Global Support services not included in the Elite offering

Remote Help Desk, 24x7x365 – Our four Global Services Operations Centers (herein referred to as GSOC) locations are your first point of contact available to you with an average-speed-of-answer of 90 seconds on the phone, or available via email or online portal. Whether they help you diagnose a problem, implement a repair remotely, or escalate to a specialist, they are working with you to help get up and running as quickly as possible.

Repair/Replacement Facilitation – Some equipment may be repairable or replaced at no charge under the manufacturer’s Warranty policy. Labor for onsite installation of parts covered under manufacturer warranty may be subject to our current standard time and material rates. The Help Desk will assist you to arrange return of the defective equipment to the manufacturer for service/replacement.

Software Updates and Upgrades – You will receive the latest software updates and upgrades remotely available per manufacturer recommendation. Updates are provided on a fix or fail basis. Once an issue is reported, the Remote Help Desk coordinates with you and the manufacturer to determine the best course of action. If a specialist or a programmer, onsite help, or any other labor is required, additional charges may apply at the applicable rate for those services.

Incident Reporting Tool – We provide an online tool to keep you up to date on ticket creation and frequency. This valuable insight allows you to make educated decisions based on room performance and uptime during annual business reviews.

Unlimited Onsite Support – We provide unlimited onsite technical support Monday through Friday 8AM to 5PM, excluding company holidays, travel included. Where applicable, we will provide a two-business day onsite response following the Help Desk’s determination that an onsite dispatch is needed. Next Business Day Response is available as a PLUS offering and are subject to additional costs and fees.

Time & Material Contract Rate Sheet



Global Help Desk Support – Case creation and management, basic troubleshooting, dispatch orders and part orders through the duration of the case:

Global Help Desk Support Services	Rate (per case/ticket)				
	USA	Canada	UK	EMEA	APAC
Remote Support Time & Materials	US \$150	C\$160	£120	€ 140	US \$150

- Global Helpdesk Remote Support available 24x7x365

Specialist Support – Infrastructure configuration, programming, software upgrades, and other advanced support:

Global Help Desk Support Services - Specialist	Hourly Rate				
	USA	Canada	UK	EMEA	APAC
Specialist Support Time & Materials *1-hour minimum (billed in 15min increments thereafter)	US \$150	C\$160	£120	€ 140	US \$150

- Specialist Support available Standard Business Hours: Monday - Friday 8:00 am to 5:00 pm local time
- No guaranteed response times or SLAs provided for T&M
- Hourly rates for Specialist Support billed in addition to initial Global Help Desk remote support fee

Onsite Dispatch – Provision of onsite technical support (troubleshooting, decommission, replace, etc.):

Onsite Dispatch Services (Contract Rates)	Hourly Rate				
	USA	Canada	UK	EMEA	APAC
Time & Material – Standard Business Hours	US \$120	C\$160	£95	€ 110	US \$120
Time & Material – Outside Standard Business Hours	US \$180	C\$240	£145	€ 170	US \$180
Time & Material – AVI-SPL Holiday	US \$240	C\$320	£195	€ 225	US \$240

- 2-hour minimum billing for onsite service (inclusive of travel time)
- Standard Business Hours: Monday through Friday 8:00 am to 5:00 pm local time
- Contract rates apply with any active Remote Customer Care or ServiceFlex T&M Contract
- No guaranteed response times or SLAs provided
- Non-contract rates will apply on non-renewal of contract
- Travel: Hourly rates apply portal to portal (excludes airfare)
- USD Rates are valid in the continental US and APAC

Signature Page - Proposal # 321748 - B

This Agreement (including all Orders, Schedules, amendments, addenda, attachments and exhibits referred to in this Agreement) constitutes the entire agreement between the Parties with respect to its subject matter and constitutes and supersedes all prior agreements, representations and understandings of the Parties, written or oral.

Payment terms are **Net 30 Days from the date of invoice unless otherwise agreed.**

Any Maintenance Services and RMS NRC outlined within this agreement will be invoiced in full upon execution of the agreement. Any OMS Services and RMS MRC outlined in this agreement will be invoiced Monthly. All fees and payments outlined in this agreement are in US Dollars.

I hereby acknowledge that I have read, understand and agree to all of the description of services, statement of coverage, including the terms and conditions, and understand and agree to the charges for such service listed or referenced herein. I also acknowledge that I am authorized by the customer to order the service as listed within this agreement.

IN WITNESS WHEREOF, the Party has duly executed this Agreement as of the Effective Date.

Elect either Term 1 or Term 2 Service Support Solution:

Term 1 coverage in the amount of: **\$4,599.15**

Term 2 coverage in the amount of: **\$5,177.84**

*** any and all applicable taxes will be included upon invoicing**

*See Addendum
Attached hereto*

Signature: _____
Print Name: _____
Title _____
Date: _____

3301 Benjamin Road, Suite 101
 Tampa, FL 33634
 Tel. 866.708.5034
 www.avispl.com

Prepared by: Stacey Thompson
 Date Prepared: 05/29/20
 Proposal #: 321748 - B
 Proposal Valid Until: 5/31/2020

Doing Business As **Audio Visual Innovations, Inc.**

Previous Contract Exp. Date: 5/31/2020

Line#	System/Room Name	Location	Serial No.	Start Date	Term 1 End Date	Term 2 End Date	Qty.	Service Description	Term 1 Unit Price	Term 1 Extended Price	Term 2 Unit Price	Term 2 Extended Price	
Maintenance Services													
AV Room Services													
1	Chambers	9293 Harding Ave Surfside, FL 33154-3000		10/1/2020	9/30/2024	9/30/2025	1	Elite - Chambers	\$4,599.15	\$4,599.15	\$5,177.84	\$5,177.84	
										Term 1 Grand Total	\$4,599.15	Term 2 Grand Total	\$5,177.84

NOTES:

Audio Visual Innovations Inc. and Signal Perfection Ltd are wholly owned subsidiaries of AVI-SPL, Inc. This Entire Document and all information presented by any subsidiary are the property of AVI-SPL Inc. Proprietary information provided to potential customers, clients or agents is for the sole purpose of demonstrating solutions delivery capabilities and shall be held in confidence. These Materials may not be copied, distributed or disclosed in any way without the sole written permission of an authorized representative of AVI-SPL. © Copyright AVI-SPL. All Rights Reserved

AudioVisual Solutions Proposal For

TOWN OF SURFSIDE

Zoom Room Integration with Chambers

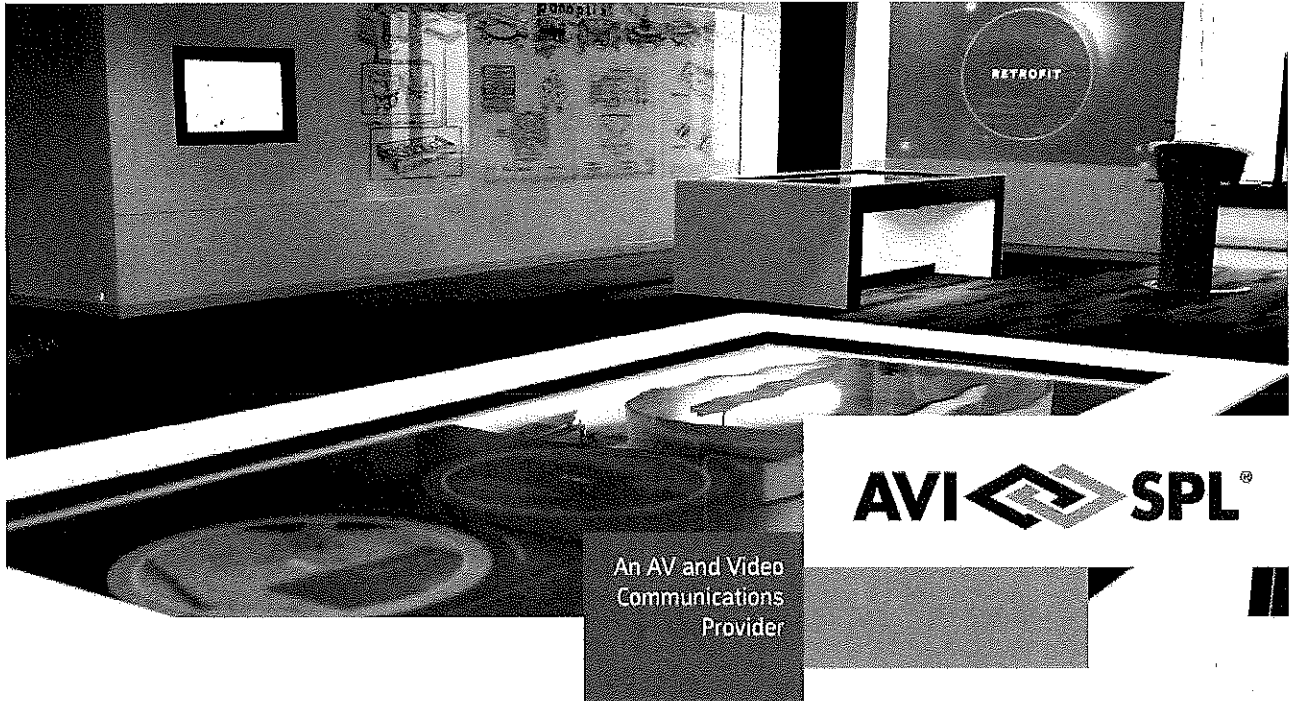

AVI  **SPL**®

An AV and Video
Communications
Provider

AVI  **SPL**®

Audio Visual Innovations, Inc. - A wholly owned subsidiary of AVI-SPL, Inc.

772 South Military Trail
Deerfield Beach, FL 33442
(954) 938-9382
Fax: (954) 776-4772
www.avispl.com

Prepared By: Debra Blanco
Debra.Blanco@avispl.com

Proposal No: 333123-1



Executive Summary

AVI-SPL is pleased to present you with the following audiovisual solutions proposal for your project.

At AVI-SPL, we are experts in applying the industry's most advanced audiovisual technologies. We translate this expertise into value for our clients through highly-customized systems integration solutions, equipment sales and services. We are proud to serve as the industry's largest global integrator, delivering comprehensive AV technology, presentation and collaboration solutions worldwide.

With nearly 40 offices nationwide, as well as international locations in Canada, United Kingdom and Dubai, AVI-SPL's Systems Integration Division is the largest and best trained in the industry, providing custom design and installation services for meeting rooms, boardrooms and collaboration spaces, network operation centers, government commission chambers, computer classrooms and distance learning facilities. We also provide incredible audiovisual enhancements to venues such as sports stadiums, casinos, theme parks, museums and houses of worship. Our portfolio also includes more than 40 professional sports stadiums and arena installations.

As part of our many levels of differentiation when compared to our competitors, large and small, is AVI-SPL's commitment to the professional development of our engineering technical staff. We accomplish this by holding our staff accountable to the highest quality solutions delivery standards that we reinforce through ongoing and consistent training.

In addition, we have established an open feedback loop with our customers and partners to continuously assess and identify the best technology and solutions.

We have applied this experience and expertise to build this custom proposal. This proposal document is based on our understanding of your specific needs and business objectives and includes a summary of the solution elements, installation requirements, investment summary and terms and conditions.

We would like to thank you for considering AVI-SPL for your project.



The AVI-SPL Process

AVI-SPL has developed a comprehensive integration process designed to meet our customer expectations. Our process begins with system design and carries through to post-installation training to ensure technology adoption. Our goal at AVI-SPL is to work with you every step of the way to ensure that your project is completed within scope, on schedule and within budget.

Proposal and Systems Design

AVI-SPL will conduct an initial detailed consultation and needs analysis with key customer stakeholders to gain a thorough understanding of needs, objectives and success criteria. This information is used to develop a proposed system solution for acceptance. This step provides Account Management and applicable Engineering Design support the ability to design a technically sound and functional solution where we will:

- Verify initial design concepts through examination of the desired capabilities, architectural and environmental considerations.
- Define scope of work criteria.
- Select the appropriate equipment, hardware and software to allow system design performance.
- Provide any value engineering and performance enhancement recommendations.

The result of the proposal and systems design phase is a system designed specifically to meet the requirements that are unique to your application.

AVI-SPL Project Delivery Process Flow

Upon award, the project is turned over to the AVI-SPL Project Integration Team. This phase is critical in ensuring a seamless integration of the specified system. During project delivery, the AVI-SPL System Integration (SIG) Operations Workflow contains distinct process steps start to finish upon award as noted below.

During project delivery AVI-SPL will (as applicable to the specific project):

- Complete internal and external kick off requirements to review:
 - Scope of Work and Design
 - Contract Parameters, including Terms and Conditions
 - Stakeholder Reporting and Communication
 - Schedule (including all WBS project tasks and timelines)
 - Submittal requirements
 - Procurement Plan
 - Risk Identifiers
 - Site Safety and Security
 - Change Management Procedures
 - Acceptance Test Plan Parameters
- Create all final construction/field coordination requirements including:
 - Floor, reflected ceiling, riser diagrams and furniture requirements.
 - AV Design drawings including audio/video/control signal flow and equipment rack elevations.
- Provide a user interface design requiring client sign off; this is a critical project success factor without it additional charges may apply.
- Create the source code for the system based on the design as agreed upon.
- Test and Commission AV systems in AVI-SPL shop, based upon acceptance test plan parameters.

Audio Visual Innovations Inc. and Signal Perfection Ltd are wholly owned subsidiaries of AVI-SPL, Inc. This Entire Document and all information (including drawings, specifications and designs) presented by any subsidiary are the property of AVI-SPL Inc. Proprietary information provided to potential customers, clients or agents is for the sole purpose of demonstrating solutions delivery capabilities and shall be held in confidence. These Materials may not be copied, distributed or disclosed in any way without the sole written permission of an authorized representative of AVI-SPL. © Copyright AVI-SPL. All Rights Reserved



- Complete all field installation of cable and equipment, based on project scope and schedule requirements.
- Test and Commission the completed system in the field, based upon acceptance test plan parameters.
- Document and address any punch list items, upon client inspection, following final commissioning.
- Demonstrate full operation of the system to the Customer and train the Customer support staff on the proper use, care and basic troubleshooting of the systems provided.
- Provide final close out (as-built) documentation including:
 - As-Built Drawings
 - Final Acceptance Test Plan Document
 - Programming Source Code
 - Project Serial Numbers and Equipment Information
- Acquire the applicable sign off on system for final invoicing and start of the applicable service term.

During project delivery the Customer will:

- Adhere to any client required tasks/milestones as noted in the agreed to project schedule.
- Coordinate with AVI-SPL regarding any network requirements and information.
- Provide any and all the Customer logos and specific color requirements for the control system user interface.
- Sign-off on the user interface design.
- Upon completion of the system installation and testing, inspect the system and provide conditional and/or final acceptance of the system, based upon the agreed upon scope of work.
- Provide final sign off of the system upon completion.

Project Coordination and Site Installation:

AVI-SPL will designate a Project Manager, who will be the main contact for directing and managing all project coordination with all project stakeholders; both externally and internal to the AVI-SPL project team.

The AVI-SPL Project Manager is responsible for attending project calls/ meetings for the project duration and consistent communication. AVI-SPL is committed to keeping you informed from the beginning to the end of your project. Initial communication will include contact information and organization of the AVI-SPL team that will be working with you. Shortly thereafter, you will begin receiving project status reports from the technical project team member responsible for routine contact throughout the entire project.

The onsite installation effort is coordinated by the Project Manager and Lead Installer. The Lead Installer will be on site directing the installation teams. Prior to delivery and installation of pre-assembled systems, AVI-SPL will field verify conformance of installed cabling and other conditions necessary to assure efficient integration of systems and devices. The Project Manager will determine the correct resources required for the specific installation tasks. In cases where AVI-SPL will utilize vetted and approved subcontractors on the project, the Project Manager and Lead Install provides proper supervision to ensure policies and procedures are being adhered to.

All installation work is thoroughly checked prior to 'turn on'. Errors or problems are corrected as detected and all equipment is adjusted for optimal performance in accord with the project specifications. By adhering to strict engineering policies and standards, the final punch list for projects of this type is typically limited to just a few items.

- Adherence to our quality assurance program.
- Installation of fully tested and "burned in" electronic hardware.
- Termination into fully tested and verified cabling and far end connections.

Audio Visual Innovations Inc. and Signal Perfection Ltd are wholly owned subsidiaries of AVI-SPL, Inc. This Entire Document and all information (including drawings, specifications and designs) presented by any subsidiary are the property of AVI-SPL Inc. Proprietary information provided to potential customers, clients or agents is for the sole purpose of demonstrating solutions delivery capabilities and shall be held in confidence. These Materials may not be copied, distributed or disclosed in any way without the sole written permission of an authorized representative of AVI-SPL. © Copyright AVI-SPL. All Rights Reserved



- Correcting site specific problems as they are detected.

The Customer shall provide an environment that is 'clean and ready' to receive the equipment and services described herein. The environment shall be secure and free of dust, debris and conditions that might prove detrimental to the equipment provided or personnel on site.

Customer required or provided items (Owner Furnished Equipment - "OFE") and client required scope are detailed in this proposal. Any charges for return trips required of AVI-SPL based on insufficient or incomplete client milestones/deliverables will be the responsibility of the Customer.

The Customer must provide an internal IT contact to assist with any network coordination where required.

Change Management

The AVI-SPL change management process provides a mechanism for changes to the agreed upon scope of work of the project. Change requests can be initiated by authorized client requestors to the Project Manager of record at any time. Unless otherwise indicated, the AVI-SPL Change Management Process includes the following stages:

- Client requests a specific change
- AVI-SPL reviews change request compared to approved Scope of Work for potential impact of:
 - Budget
 - Schedule / Time
 - Programming / Function
- AVI-SPL provides written change order response / proposal
- Client executes approval of proposed change order
 - A formal change to contract / purchase order (if applicable) required.
- AVI-SPL proceeds with applicable performance requirements of change order (equipment order, resource time and appropriate scheduling)

All change requests must be made in writing or discussed with the Project Manager of record by the Customer (or client representative with authority to approve changes of agreed upon scope of work) for review and impact considerations. Written authorization to proceed, which may include formal changes to the contract or purchase order, must be provided to AVI-SPL prior to the release of any resources, time or equipment acquisition for a requested change order.

Project Managers may also leverage the change management process to notify the Customer of necessary change in system components or design if required.

Training, System Turnover and Project Completion

An integral part of the delivered system is user training. AVI-SPL is committed to providing you with clear and concise instructions on the use of each system. Training and associated documentation will provide operational and maintenance personnel with information to support the daily use of the system. This training will consist of demonstration, instruction and hands-on experience with each system.

System Turnover will occur when all user training has been completed and the users have obtained beneficial use of the systems. At this point, AVI-SPL will request client sign off on the provided systems. Conditional Project Sign-Off will apply if outstanding punch list items exist. AVI-SPL will set forth a plan to address these items accordingly.

Project Completion will occur when all outstanding punch list items are complete and all As-Built documentation has been provided to the Customer in the decided upon delivery method including; Project drawings, functional system diagrams, applicable equipment lists, back up control system and DSP code. At this time, Final Project Sign-Off will be requested.

Audio Visual Innovations Inc. and Signal Perfection Ltd are wholly owned subsidiaries of AVI-SPL, Inc. This Entire Document and all information (including drawings, specifications and designs) presented by any subsidiary are the property of AVI-SPL Inc. Proprietary information provided to potential customers, clients or agents is for the sole purpose of demonstrating solutions delivery capabilities and shall be held in confidence. These Materials may not be copied, distributed or disclosed in any way without the sole written permission of an authorized representative of AVI-SPL. © Copyright AVI-SPL. All Rights Reserved



AVI-SPL Support and Maintenance Offering Overview

AVI-SPL's Global Support offerings provide world class services designed to help you achieve the most uptime and the best Return on Investment (ROI) from your technology investment. We utilize our 40 years of experience with 700+ manufacturer technologies to become the service partner you can count on.

	Essential (T&M)	Enhanced	Elite
Unlimited Remote Help Desk, 24x7		●	●
Unlimited Onsite Support, 8x5			●
In Manufacturer-Warranty Hardware Support	●	●	●

Support Services are provided on a per-room or per-project basis.

Essential (Time & Materials)

Full suite of Global Support offerings available in a noncontract form, all billable at standard AVI-SPL rates (See rate table).

Billable Offerings:

- Remote Help Desk, 24x7
- Onsite Technical Dispatch
- Specialist Remote Support
- Parts Repair and Replacement

Enhanced

- Offers unlimited remote help desk support – available 24x7x365.
- Facilitates the repair or replacement of manufacturer programs for applicable hardware.
- Access to software updates and upgrades for hardware covered by manufacturer program.
- Use of online incident reporting tool for easy ticket awareness.
- Eligibility for discounted hourly rates when other Global Support services not included in the Enhanced offering are requested.

Elite

- Offers unlimited onsite technical dispatch.
- Offers unlimited remote help desk support – available 24x7x365.
- Facilitates and performs the repair or replacement programs of manufacturer programs for applicable hardware.
- Access to software updates and upgrades for hardware covered by manufacturer program.
- Use of online incident reporting tool for easy ticket awareness.
- Eligibility for discounted hourly rates when other Global Support services not included in the Elite offering are requested

Audio Visual Innovations Inc. and Signal Perfection Ltd are wholly owned subsidiaries of AVI-SPL, Inc. This Entire Document and all information (including drawings, specifications and designs) presented by any subsidiary are the property of AVI-SPL Inc. Proprietary information provided to potential customers, clients or agents is for the sole purpose of demonstrating solutions delivery capabilities and shall be held in confidence. These Materials may not be copied, distributed or disclosed in any way without the sole written permission of an authorized representative of AVI-SPL. © Copyright AVI-SPL. All Rights Reserved



AVI-SPL Global Support Plus Options

PLUS Options are available at an additional cost.

Our Global Support Plus Options are additions to the Global Support, customized to your unique environment. PLUS Options allow us to take on more of the risk associated with aging equipment, help prevent unexpected expenses, and provide an enhanced onsite response time to get spaces up and running. Add one or multiple options to enable the flexibility needed.

PLUS Offerings

Extended Hardware Warranty	Corrective Maintenance Visit
Enhanced Onsite Response: 4 Hour or Next Business Day*	Loaner Equipment
Preventative Maintenance Visit	Consumable Replacement
<p>Extended Hardware Warranty We cover repair or replacement cost of malfunctioning equipment. Unforeseen expenses drop significantly as we assume the risk of replacement parts of aging equipment.</p> <p><small>*Owner Furnished Equipment not Included</small></p>	<p>Corrective Maintenance Visit Onsite maintenance visits that can be purchased up-front and scheduled after a fault has been found to resolve a hardware or software issue and bring the room back to operating specifications.</p>
<p>Enhanced Onsite Response Optional Next Business Day or 4 Hour onsite response (each purchased separately) provide the fastest response possible to keep mission critical situations from escalating.</p> <p><small>*Not available in all areas. Subject to AVI-SPL approval</small></p>	<p>Loaner Equipment We reduce down time by keeping rooms fully functional while a final repair is executed. We provide a functionally equivalent piece of equipment.</p> <p><small>*Not available in all areas. Subject to AVI-SPL approval</small></p>
<p>Preventative Maintenance Check Discover a potential issue before a meeting. Onsite visits that work around scheduled use of space to ensure equipment is kept in optimal operating conditions. Onsite technicians complete a standard checklist, and make recommendations to enhance reliability, features, and security.</p>	<p>Consumable Replacement Proper maintenance is essential to ensuring equipment reaches it maximum lifespan. Mitigate unknown expenses by including high-volume points of failure (examples include: lamps, bulbs, filters, fuses, batteries).</p> <p><small>*Not available in all areas. Subject to AVI-SPL approval</small></p>

Audio Visual Innovations Inc. and Signal Perfection Ltd are wholly owned subsidiaries of AVI-SPL, Inc. This Entire Document and all information (including drawings, specifications and designs) presented by any subsidiary are the property of AVI-SPL Inc. Proprietary information provided to potential customers, clients or agents is for the sole purpose of demonstrating solutions delivery capabilities and shall be held in confidence. These Materials may not be copied, distributed or disclosed in any way without the sole written permission of an authorized representative of AVI-SPL. © Copyright AVI-SPL. All Rights Reserved



Investment Summary

Prepared For:	JOSE FELIZ
	TOWN OF SURFSIDE
	9293 Harding Ave
	Surfside, FL 33154-3000

Prepared By:	Debra Blanco
Date Prepared:	06/04/2020
Proposal #:	333123-1
Valid Until:	08/04/2020

Total Equipment Cost **\$3,335.24**
 Includes cable, connectors, hardware, switches, relays, terminal blocks, panels, etc., to ensure complete and operational system

Professional Integration Services **\$4,884.00**
 Includes engineering, project management, CAD, on-site installation and wiring, coordination and supervision, testing, checkout, owner training, etc. performed on the Owner's premises. Also includes all fabrication, modification, assembly, rack wiring, programming, warranties, etc., some performed at AVI-SPL

Direct Costs **\$0.00**
 Includes non equipment or labor costs, such as travel expenses, per diem, lift and vehicle rentals

General & Administrative **\$114.86**
 Includes all G & A expenses: bonds, vehicle mileage, shipping and insurance

Services - Room Support and Maintenance **\$1,164.00**
 Includes post-installation support and maintenance options selected for installed rooms

Subtotal	\$9,498.10
Tax	\$664.87
Total	\$10,162.97

* any and all applicable taxes will be included upon invoicing

Purchase orders should be addressed to Audio Visual Innovations, Inc.

*Addendum
see Attached
Here to*

Signed _____ Printed _____ Date _____

Audio Visual Innovations Inc. and Signal Perfection Ltd are wholly owned subsidiaries of AVI-SPL, Inc. This Entire Document and all information (including drawings, specifications and designs) presented by any subsidiary are the property of AVI-SPL Inc. Proprietary information provided to potential customers, clients or agents is for the sole purpose of demonstrating solutions delivery capabilities and shall be held in confidence. These Materials may not be copied, distributed or disclosed in any way without the sole written permission of an authorized representative of AVI-SPL. © Copyright AVI-SPL. All Rights Reserved



Services Summary



Audio Visual Innovations Inc. and Signal Perfection Ltd are wholly owned subsidiaries of AVI-SPL, Inc. This Entire Document and all information (including drawings, specifications and designs) presented by any subsidiary are the property of AVI-SPL Inc. Proprietary information provided to potential customers, clients or agents is for the sole purpose of demonstrating solutions delivery capabilities and shall be held in confidence. These Materials may not be copied, distributed or disclosed in any way without the sole written permission of an authorized representative of AVI-SPL. © Copyright AVI-SPL. All Rights Reserved



Room Summary - Zoom Integration

Equipment List

Mfg	Model	Description	Qty	Unit Price	Extended Price
		Conferencing Audio			
BIAMP SYSTEMS	BIATESIRAAVB1CK	AVB NETWORK CARD KIT (UNINSTALLED)	1	\$517.07	\$517.07
BIAMP SYSTEMS	BIATESIRAEXUBT	EXPANDER, POE AVB/USB WITH BLUEETOOTH	1	\$426.83	\$426.83
TRENDNET	TRETIIG30	POE+ INJECTOR GIGABIT 56V DC INPUT 1/10/100/1000BASE-T	1	\$110.68	\$110.68
BLACK MAGIC DESIGN USA	BLACONVNTRMCBAUSD I	CONVERTER, TERANEX MINI - AUDIO TO SDI 12G	1	\$482.93	\$482.93
		Conferencing Video			
OFE	OFE	CONFERENCING COMPUTER WITH 2 HDMI AND 2 USB (Owner Furnished Equipment)	2	OFE	OFE
AJA VIDEO SYSTEMS	AJA3GDA	DISTRIBUTION AMPLIFIER, 1X6 3G HD/SD SDI RELOCKING, 120M	1	\$361.28	\$361.28
DECIMATOR DESIGN	DECMDHX	CROSS CONVERTER, HDMI/SDI W/ SCALING & RATE CONVERSION	1	\$334.66	\$334.66
BLACK MAGIC DESIGN USA	BLABDLKWEBPTR	WEB PRESENTER	1	\$482.93	\$482.93
		Accessories			
BLACK MAGIC DESIGN USA	BLACONVNTRMYASMT N	USER INTERFACE, TERANEX MINI - SMART PANEL	2	\$82.93	\$165.86
BLACK MAGIC DESIGN USA	BLACONVNTRMYARSH	SHELF, TERANEX MINI - RACK SHELF	1	\$82.93	\$82.93
MONOPRICE.COM	MON16183	CABLE, 6' VIPER SERIES HD-SDI RG6 BNC	4	\$10.24	\$40.96
MONOPRICE.COM	MON16181	CABLE, 1.5' VIPER SERIES HD-SDI RG6 BNC	4	\$5.84	\$23.36
				Subtotal	\$3,029.49

Room Support and Maintenance

Elite Maintenance Services - Room; 12-months

\$1,164.00

Audio Visual Innovations Inc. and Signal Perfection Ltd are wholly owned subsidiaries of AVI-SPL, Inc. This Entire Document and all information (including drawings, specifications and designs) presented by any subsidiary are the property of AVI-SPL Inc. Proprietary information provided to potential customers, clients or agents is for the sole purpose of demonstrating solutions delivery capabilities and shall be held in confidence. These Materials may not be copied, distributed or disclosed in any way without the sole written permission of an authorized representative of AVI-SPL. © Copyright AVI-SPL. All Rights Reserved
AVI-SPL, Inc.

Proposal #: 333123-1

10 | Page



Equipment Total	\$3,029.49
Installation Materials	\$305.75
Professional Services	\$4,884.00
Direct Costs	\$0.00
General & Administrative	\$114.86
Services - Room Support and Maintenance	\$1,164.00
Subtotal	\$9,498.10

For informational purposes only – all Purchase Orders must match Investment Summary details.



Integration Inclusions & Exclusions

Inclusions

The following items are INCLUDED in this proposal unless specifically noted otherwise within this proposal document or scope of work statement:

- All equipment, wire and accessories required for a fully functional audio/visual system per the agreed upon scope of work.
- Non-union labor associated with audio/visual system engineering, installation, programming and testing.
- Documentation package including complete as-built AV system diagrams and manufacturer's operation manuals.
- Coordination and cooperation with the construction team in regard to installing the system.
- User demonstration of full AV system operation for final sign-off.

Any additional trips, labor or materials due to failure of the other work forces to have the audiovisual system rough-in work completed as anticipated and previously confirmed, will be added to the project billing as required.

Where applicable, the owner's architect will provide AVI-SPL's engineering department with all required architectural floor, reflected ceiling, building elevation, and section plans in AutoCAD® format at no charge to AVI-SPL.

Exclusions

The following items are EXCLUDED from this proposal unless specifically identified otherwise within this proposal document or scope of work statement.

- All conduits, high voltage wiring panels, breakers, relays, boxes, receptacles, etc. Any related electrical work including but not limited to 110VAC, conduit, core drilling, raceway and boxes.
- Voice/data cabling, IE analogue phone lines, ISDN lines, network ports, etc.
- Network connectivity, routing, switching and port configuration necessary to support audiovisual equipment.
- Concrete saw cutting and/or core drilling.
- Fire wall, ceiling, roof and floor penetration, patching, removal or fire stopping.
- Necessary sheet rock replacement, ceiling tile, T-bar replacement and/or wall/ceiling repair.
- Any and all millwork (moldings, trim, etc.). All millwork or modifications to project millwork/furniture to accommodate the AV equipment is to be provided by others.
- Painting, patching or finishing of architectural surfaces.
- Permits
- Engineered (P.E.) seals and/or stamped structural/system details.
- HVAC and plumbing relocation.
- Rough-in, bracing, framing or finish trim carpentry for installation.
- Cutting, structural welding, or reinforcement of structural steel members required for support of assemblies, if required.
- Owner furnished equipment or equipment furnished by others that is integrated into the systems (as described above) is assumed to be current, industry acceptable and in good working order. If it is determined that this equipment is faulty upon installation, additional project charges may be incurred.
- Warranty or Customer Care service coverage for Owner furnished equipment or equipment furnished by others.
- Additional or specific manufacturer's "User Adoption" training.
- Additional costs for union labor.

Audio Visual Innovations Inc. and Signal Perfection Ltd are wholly owned subsidiaries of AVI-SPL, Inc. This Entire Document and all information (including drawings, specifications and designs) presented by any subsidiary are the property of AVI-SPL Inc. Proprietary information provided to potential customers, clients or agents is for the sole purpose of demonstrating solutions delivery capabilities and shall be held in confidence. These Materials may not be copied, distributed or disclosed in any way without the sole written permission of an authorized representative of AVI-SPL. © Copyright AVI-SPL. All Rights Reserved



General Terms and Conditions

1. Applicability of Terms

1.1 These General Terms and Conditions (together with any addenda attached hereto and incorporated herein by this reference, the "Terms and Conditions") and the accompanying Audiovisual Solutions Proposal (the "Proposal") are the only terms and conditions which govern the sale of the equipment and any related software (the "Products") and services (the "Services") specified in the Proposal by Audio Visual Innovations, Inc. or Signal Perfection Ltd. (as applicable, "Seller") to the buyer/customer identified in the Proposal ("Buyer"). Seller and Buyer may be individually referred to as a "Party" and collectively as "Parties."

1.2 The Terms and Conditions and the Proposal (collectively, the "Agreement") comprise the entire agreement between the parties, and supersede all prior or contemporaneous understandings, agreements, negotiations, representations and warranties, and communications, both written and oral. In the event of a conflict or inconsistency between the General Terms and Conditions and any addendum, the addendum shall prevail to the extent of such conflict or inconsistency. In the event of a conflict between the Terms and Conditions and the Proposal, the Terms and Conditions shall prevail to the extent of such conflict or inconsistency. Notwithstanding anything herein to the contrary, if a master services agreement signed by both Parties is in effect covering the sale of the Products and Services that are the subject of the Proposal, the terms and conditions of said agreement shall prevail to the extent they conflict or are inconsistent with these Terms and Conditions.

2. Acceptance and Modification of Terms

2.1 This Agreement shall not be binding upon Seller until accepted by Buyer as set forth in this sub-Section 2.1 and the earlier of Seller's confirmation in writing of Buyer's order and Seller's performance under the applicable Proposal. Buyer's signed acceptance of the Agreement, issuance of order against the Agreement, payment for any of the Products or Services contained in the Agreement, or receipt of the Products or Services contained in the Agreement, whichever occurs first, shall constitute Buyer's acceptance of this Agreement.

2.2 Any modification, addition to, or waiver of any of this Agreement shall not be effective unless in writing and signed by an authorized representative of Seller, and any different or conflicting terms appearing in Buyer's purchase order or other documents are expressly rejected by Seller. No relaxation, forbearance or indulgence by a Party in enforcing any of the terms and conditions of this Agreement or the granting of any time to the other Party shall prejudice or restrict the rights and powers of a Party hereunder, nor shall waiver of any breach hereof operate as a waiver of any subsequent or continuing breach hereof.

3. Delivery

3.1 Seller will use its best efforts to deliver the Products in accordance with the Buyer requested delivery date, subject to receipt of all necessary information from Buyer and Buyer's compliance with Seller's reasonable instructions for site readiness. Shipping dates are approximate only, and Seller shall not be liable for failures of or delays in manufacture, delivery or installation resulting from any cause or causes beyond its reasonable control and without its fault or negligence.

3.2 Any delay due to causes beyond Seller's reasonable control and without Seller's fault or negligence shall extend delivery dates to the extent caused thereby. Seller will use reasonable efforts to timely notify Buyer in the event of a delay. Buyer shall reimburse the Seller its reasonable additional expenses resulting from any Buyer-caused delay. When delivery of the Products is delayed at the request of the Buyer and the Products have already been shipped by Seller's vendor, Seller will place the Products in storage and invoice Buyer the price of such Products, which will be promptly paid. Seller shall not be liable, and the Buyer shall have no right to cancel or rescind this Agreement, in the event of any delay due to causes beyond Seller's reasonable control and without Seller's fault or negligence, and Buyer shall accept such delayed performance by Seller. The Buyer's receipt of the Products shall constitute a waiver of any claims for delay.

4. Billing and Payment Terms

Unless otherwise agreed in writing by Buyer and Seller in the Proposal, the total Proposal price, excluding the price for Stand-alone Services (as defined in this section), shall be billed as follows: 50% down payment at time of order, 40% upon delivery at Seller; 10% upon project completion and Buyer sign-off or first beneficial use, whichever occurs first, payable net 30 from Buyer's receipt of invoice. For purposes of this Agreement, "Stand-alone Services" means any Services not attached to an installation project. Unless otherwise specified in the Proposal, Products are sold F.O.B. origin-Buyer to pay all shipping charges. If this Proposal covers Products or Services for more than one system, room, suite, or location, for purposes of payment in accordance with payment terms stated on the face hereof each room, suite, or location shall be treated as if the subject of a separate sale and payment made accordingly. Unless otherwise specified in the Proposal, all pricing and amounts are in US Dollars and all billing and payment shall be made in US Dollars.

5. Buyer in Arrears or Default

In the event Buyer is in arrears with any payment whatsoever due from it to Seller at any time, whether in respect of the Proposal price or any other amount due from the Buyer to the Seller under the terms of this Agreement, the amount in arrears shall bear interest at the rate of 1.5% per month or the maximum rate permitted by applicable law, whichever is less, as from the date each amount falls due, pending actual payment thereof in full, without prejudice to any relief or remedy available to Seller. In the event of Buyer's default, Seller may, without notice, peaceably enter any premises in which the Products are located and remove, hold and sell them in accordance with applicable law, to satisfy in whole or in part Buyer's obligations.

6. Title and Risk of Loss

6.1 Title to the Products shall pass to Buyer upon delivery, subject to the manufacturer's or Seller's software license (if applicable) and a purchase money security interest retained by Seller in the Products sold and the proceeds thereof until payment of all amounts then due to Seller. Seller shall be entitled to remove the Products from the Buyer's premises if all payments are not made when due. ~~Buyer agrees to reasonably cooperate with Seller in the execution and filing of financing statements under the Uniform Commercial Code or other documents as Seller reasonably requests to protect its security interest.~~

Audio Visual Innovations Inc. and Signal Perfection Ltd are wholly owned subsidiaries of AVI-SPL, Inc. This Entire Document and all information (including drawings, specifications and designs) presented by any subsidiary are the property of AVI-SPL Inc. Proprietary information provided to potential customers, clients or agents is for the sole purpose of demonstrating solutions delivery capabilities and shall be held in confidence. These Materials may not be copied, distributed or disclosed in any way without the sole written permission of an authorized representative of AVI-SPL. © Copyright AVISPL. All Rights Reserved



6.2 Risk of loss or damage to the Products or any part thereof shall pass to the Buyer upon delivery.

7. Installation and Site Preparation

7.1 Installation (e.g. field assembly, interconnection, equipment calibration and checkout) is to be performed by the Seller's trained technical employees. The Seller shall be entitled to employ subcontractors and/or agents to assist in or carry out, in whole or in part, the installation. ~~In the event installation by Seller employees is prevented by trade unions, the Buyer shall arrange with the trade unions at its own expense to complete installation. The Seller is thereafter liable only for engineering supervision of installation.~~

7.2 The Seller shall reasonably coordinate and cooperate with other trades to facilitate satisfactory work progress. If the Seller's work in progress is impeded by other trades and/or contractors (excluding the Seller's own subcontractors) or by scheduling delays due to the Buyer, time delays in the final installation as well as additional charges, including labor, travel and other reasonable expenses, may result.

7.3 The Buyer shall be responsible for preparing, at its own expense, the installation site in accordance with the Seller's reasonable instructions, including the requirements specified in the Proposal. In no event shall the Seller be responsible for any high voltage electrical work, ceiling modifications, structural modifications, or mechanical systems modifications. Unless otherwise agreed in writing in the Proposal, Buyer shall provide the Seller with source code for any non-Seller programmed remote control system required to be modified under the terms of this Agreement.

8. Access to Project Site

8.1 The Buyer shall provide the Seller with reasonable access to the installation site before delivery, for purposes of determining site readiness for installation, and shall designate an individual on Buyer's staff to serve as a contact person for all site preparation and installation issues. Buyer shall provide the Seller with free access to the installation site for the purpose of preparation for installation.

8.2 Buyer shall obtain at its expense and keep effective all permissions, licenses, and permits whenever required in connection with the installation and/or use of the Products and the premises where the Products shall be situated.

9. Warranty

9.1 Seller warrants that:

(a) Immediately prior to delivery, it had good title to the Products, free from any lien or encumbrance unless otherwise specified;

(b) For a period of ninety (90) days from delivery and acceptance of the Products and Services, or, with respect to Products manufactured by a third party, such longer period of time provided by such manufacturer, the Products and Services will (i) be free from defects in materials or workmanship and (ii) conform to the requirements of the Proposal, including any instructions, specifications and documentation incorporated therein;

(c) It is in compliance with all applicable federal, state and local laws, regulations and standards relating to the sale and transportation of the supplies or items, and provision of the Products including all applicable U.S. and foreign anti-corruption laws, including without limitation, the U.S. Foreign Corrupt Practices Act ("FCPA"); and

(d) With respect to Services, Seller's personnel shall possess the requisite level of training, skill and experience to address the requisite tasks efficiently and will

Audio Visual Innovations Inc. and Signal Perfection Ltd are wholly owned subsidiaries of AVI-SPL, Inc. This Entire Document and all information (including drawings, specifications and designs) presented by any subsidiary are the property of AVI-SPL Inc. Proprietary information provided to potential customers, clients or agents is for the sole purpose of demonstrating solutions delivery capabilities and shall be held in confidence. These Materials may not be copied, distributed or disclosed in any way without the sole written permission of an authorized representative of AVI-SPL. © Copyright AVISPL. All Rights Reserved

perform the Services provided hereunder in a professional and workmanlike manner consistent with generally accepted industry standards.

9.2 Seller shall not be liable for nor have any warranty obligations with respect to Products that are in any way misused, altered and/or repaired by someone other than a representative of the Seller which, within the sole, reasonable judgment of the Seller, results in an adverse effect, including effects upon performance or reliability of the Products.

9.3 In order to make a warranty claim, Buyer shall promptly notify Seller in writing and Seller will, subject to the applicable manufacturer's warranty policy, repair or replace such defective Product at no cost to Buyer. Seller will attempt to reply to warranty claims received from Buyer prior to 1:00 p.m. within forty-eight hours. Normal working hours are 8 a.m. to 5 p.m., Monday through Friday, excluding legal holidays. Buyer shall reasonably and promptly cooperate with Seller's request for information regarding the claim and with return of the defective Product if required.

9.4 Except as otherwise specified in this Agreement, no warranty whatsoever is provided by the Seller hereunder as to Products manufactured by anyone other than the Seller, including but not limited to, cables, lamps, batteries, glassware, and evacuated devices (including valve, cathode ray tubes, and other special electron tubes). Seller's sole obligation with respect to Products manufactured by someone other than Seller shall be to pass through the applicable warranties, if any, provided by the manufacturer. THE WARRANTIES SET FORTH IN THIS AGREEMENT ARE EXCLUSIVE AND IN LIEU OF ALL OTHER WARRANTIES, WHETHER WRITTEN OR ORAL, IMPLIED OR STATUTORY. NO IMPLIED WARRANTY OF MERCHANTABILITY OR FITNESS FOR A PARTICULAR PURPOSE SHALL APPLY.

10. Buyer Responsibilities

Buyer or any user of the Products shall (i) notify Seller as soon as any unusual operating peculiarity appears, and (ii) operate the Products in a safe and competent manner in strict compliance with the Product specifications and operating procedures and applicable laws and government regulations. In the event the Buyer or any user of the Products fails to comply with this Section 10, Seller's warranties and its obligations hereunder shall terminate without notice to Buyer.

11. Limitation of Liability and Exclusion of Damages

TO THE FULLEST EXTENT ALLOWED BY APPLICABLE LAW, IN NO EVENT WILL EITHER PARTY BE LIABLE FOR INCIDENTAL, CONSEQUENTIAL, SPECIAL, EXEMPLARY, OR INDIRECT DAMAGES, LOST BUSINESS PROFITS, OR LOSS, DAMAGE OR DESTRUCTION OF DATA, ARISING OUT OF OR IN ANY WAY RELATED TO THIS AGREEMENT AND THE RELATIONSHIP AND/OR DEALINGS BETWEEN BUYER AND SELLER, REGARDLESS OF THE FORM OF ACTION, WHETHER IN CONTRACT, TORT (INCLUDING NEGLIGENCE), BREACH OF WARRANTY OR OTHERWISE, EVEN IF SUCH PARTY HAS BEEN ADVISED AS TO THE POSSIBILITY OF SAME, EXCEPT FOR SELLER'S GROSS NEGLIGENCE, WILLFUL MISCONDUCT OR FRAUD, SELLER'S AGGREGATE LIABILITY ARISING OUT OF OR RELATED TO THIS AGREEMENT SHALL NOT EXCEED THE TOTAL AMOUNT PAID OR PAYABLE BY BUYER UNDER THIS AGREEMENT. THE ABOVE LIMITATION WILL APPLY WHETHER AN ACTION IS IN CONTRACT OR TORT AND REGARDLESS OF THE THEORY OF LIABILITY.

12. Taxes

12.1 Any and all taxes levied or based on the prices in this Agreement, or the Products being sold hereunder, exclusive of any taxes based on net income, shall be added to the purchase prices set forth in the Proposal, except to the extent the Buyer provides the Seller with a valid tax exemption certificate approved by Seller.



12.2 All payments to be made hereunder shall be made in cleared funds, without any deduction or set-off and free and clear of and without deduction for or on account of any taxes, levies, imports, duties, charges, fees and withholdings of any nature now or hereafter imposed by any governmental, fiscal or other authority save as required by law. If Buyer is compelled to make any such deduction, it will pay to Seller such additional amounts as are necessary to ensure receipt by Seller of the full amount which Seller would have received but for the deduction.

13. Confidentiality

All Provisions subject to Florida Public Records Law
 13.1 Each Party may from time to time during the Agreement, in the course of discussions or dealings with each other, receive or learn, orally, visually or through any tangible medium, certain information regarding the other Party's business, including but not limited to, its products, inventions, operations, methodologies, systems, processes, product development plans or intentions, know-how, designs, trade secrets, market opportunities, business or financial affairs, and technical, marketing, financial, employees, planning, intellectual property and other confidential or proprietary information ("Confidential Information"). Confidential Information does not include, and the restrictions in this Agreement shall not apply with respect to, information (i) possessed by or independently developed by the receiving Party prior to any disclosure, (ii) obtained from sources other than the disclosing Party, which sources had no obligation of confidentiality to disclosing Party with respect to the Confidential Information, or (iii) which is within the public domain when disclosed or becomes part of the public domain after disclosed to the receiving Party without fault on the part of the receiving Party. Seller's Confidential Information also includes the terms of this Agreement.

13.2 The Confidential Information of a Party belongs to that Party. The receiving Party will not disclose the Confidential Information of the disclosing Party to any third party without the disclosing Party's prior written consent. The receiving Party will not use the Confidential Information of the disclosing Party for any purpose not expressly permitted by this Agreement or to carry out the Services or the sale of Products, and will disclose the Confidential Information of the disclosing Party only to the employees or contractors of the receiving Party who have a need to know such Confidential Information for purposes of carrying out the Services or the sale of Products and who are under a duty of confidentiality no less restrictive than the receiving Party's duty hereunder. Receiving Party will protect the disclosing Party's Confidential Information from unauthorized use, access, or disclosure in the same manner as the receiving Party protects its own confidential or proprietary information of a similar nature and with no less than reasonable care.

13.3 Receiving Party will, upon completion or termination of this Agreement or promptly upon request from the disclosing Party, return or destroy all Confidential Information of the disclosing Party, including any documents or materials that contain any Confidential Information of the disclosing Party. Notwithstanding anything to the contrary in this Agreement, the receiving Party (i) may retain one (1) copy of the disclosing Party's Confidential Information solely for archival, audit, disaster recovery, legal or regulatory purposes and (ii) will not be required to search archived electronic back-up files of its computer systems for the disclosing Party's Confidential Information in order to purge the disclosing Party's Confidential Information from its archived files; provided, however, that the receiving Party must (i) maintain its confidentiality under this Agreement as if it were still in effect, and (ii) not use the retained Confidential Information of the disclosing Party for any other purpose.

13.4 The Parties recognize that a violation of this Section 13 can cause irreparable harm to the business of the disclosing Party that could not be adequately compensated by the payment of money damages and agree that the disclosing Party may seek injunctive relief against any actual or threatened breach of this Section 13

Audio Visual Innovations Inc. and Signal Perfection Ltd are wholly owned subsidiaries of AVI-SPL, Inc. This Entire Document and all information (including drawings, specifications and designs) presented by any subsidiary are the property of AVI-SPL Inc. Proprietary information provided to potential customers, clients or agents is for the sole purpose of demonstrating solutions delivery capabilities and shall be held in confidence. These Materials may not be copied, distributed or disclosed in any way without the sole written permission of an authorized representative of AVI-SPL. © Copyright AVISPL. All Rights Reserved

in addition to any other available legal and equitable remedies. The prevailing Party in any action to enforce this Section 13 shall be entitled to recover from the non-prevailing Party reasonable attorneys' fees in addition to other relief granted in such action.

14. Force Majeure

Except for payment for amounts due under the Agreement, neither Party will be liable to the other for delays or failures to perform occasioned by causes beyond its reasonable control and without its fault or negligence. Such acts or events shall include but not be limited to, acts of God, civil or military authority, civil disturbance, riot, fire, strikes, lockouts or slowdowns, factory or labor conditions, inability to obtain necessary labor, materials or manufacturing facilities, and delayed issuance of export control licenses. In the event of such delays or failures to perform, any dates or times by which either Party is otherwise scheduled to perform shall be extended automatically for a period of time equal in duration to the additional time required because of the delay or failure to perform. The Party claiming force majeure shall promptly inform the other Party of any event of force majeure, and its expected duration and cessation. The Party claiming force majeure shall use its best efforts to mitigate such effects to the extent reasonably practicable.

15. Restocking Fees

In the event Buyer wishes to return any Products based on reasons outside of Seller's control, including but not limited to Buyer's cancellation or termination of this Agreement or any portion thereof for its convenience, Buyer agrees, in addition to any other amounts due under this Agreement, to reimburse Seller for any and all third party cancellation/restocking fees incurred by Seller.

16. Termination

16.1 Seller may, without prejudice to any rights or remedies available to Seller under this Agreement, at law or in equity, terminate this Agreement immediately for cause in the event Buyer breaches a material term of this Agreement (it being understood that Buyer's payment obligations shall constitute a material term) and such breach is not cured within thirty (30) days after written notice thereof. Seller may also, without prejudice to any rights or remedies available to Seller under this Agreement, at law or in equity, terminate this Agreement immediately for cause upon written notice if Buyer: (i) breaches a material term of this Agreement and such breach is incapable of cure, (ii) fails on multiple occasions to pay any amounts when due, (iii) is declared insolvent or adjudged bankrupt by any court of competent jurisdiction, or (iv) makes an assignment for the benefit of creditors, or a petition in bankruptcy or reorganization or an arrangement with creditors is filed by or against Buyer and not dismissed within thirty (30) days. Upon Seller's termination of this Agreement for cause, without waiving or otherwise limiting any other remedies available to Seller under this Agreement, at law or in equity, Buyer shall become immediately liable for any outstanding charges for Products delivered and/or Services performed up to the date of termination, any third party restocking/cancellation fees incurred by Seller, and any interest on any and all past due charges as set forth in this Agreement.

16.2 Buyer may, without prejudice to any rights or remedies available to Buyer under this Agreement, at law or in equity, terminate this Agreement immediately for cause in the event Seller breaches a material term of this Agreement and such breach is not cured within thirty (30) days after written notice thereof. Buyer may also, without prejudice to any rights or remedies available to Buyer under this Agreement, at law or in equity, terminate this Agreement immediately for cause upon written notice if Seller: (i) breaches a material term of this Agreement and such breach is incapable of cure, (ii) is declared insolvent or adjudged bankrupt by any court of competent jurisdiction, or (iii) makes an assignment for the benefit of



creditors, or a petition in bankruptcy or reorganization or an arrangement with creditors is filed by or against Buyer and not dismissed within thirty (30) days.

16.3 Buyer may, upon written notice to Seller, terminate this Agreement for its convenience provided, however, that Seller shall be paid for all Products delivered and Services performed up to the effective date of termination (less amounts already paid) plus reimbursed for any third party restocking/cancellation fees in accordance with Section 15.

16.4 Upon any expiration or termination of this Agreement, in addition to any other provisions of this Agreement that state survival after termination or expiration of this Agreement, and notwithstanding expiration, completion or termination of this Agreement, the Parties shall continue to be bound by the provisions of this Agreement that, by their nature, shall survive such completion or termination, including without limitation provisions relating to warranties, governing law and jurisdiction, and confidentiality.

17. Governing Law and Jurisdiction

17.1 This Agreement shall be interpreted in accordance with and governed in all respects by the laws of the State of Florida without giving effect to its conflicts of law rules. Any dispute related to, arising out of, or in connection with this Agreement shall be subject to the exclusive jurisdiction of the courts in ~~Willsborough County, Florida and the United States District Court for the Middle District of Florida~~ ^{in Miami-Dade County}. In the event of legal proceedings arising out of or relating to this Agreement, the prevailing Party, as determined by the court, shall be entitled to recover, from the non-prevailing Party, reasonable costs suffered or incurred in connection with such proceedings including, but not limited to, court fees, attorneys' fees, expenses and costs of investigation and court.

17.2 TO THE FULLEST EXTENT PERMITTED BY APPLICABLE LAWS, SELLER AND BUYER EACH WAIVE ANY RIGHTS WHICH EITHER MAY HAVE TO TRIAL BEFORE A JURY OF

ANY DISPUTE ARISING FROM, OR RELATED TO, THIS AGREEMENT. SELLER AND BUYER FURTHER STIPULATE AND CONSENT THAT ANY SUCH LITIGATION BEFORE A COURT OF COMPETENT JURISDICTION SHALL BE NON-JURY.

18. Miscellaneous

18.1 The Proposal shall be firm for the period shown on the face of the Proposal, subject to withdrawal or change by the Seller upon notice at any time prior to Buyer's acceptance. Notwithstanding the foregoing, the Seller shall have the right to amend the price of the Products to reflect current conditions that affect the price, including increase in raw material prices, and tariffs that had not been imposed at the time this Agreement was submitted to Buyer.

18.2 In providing the Products, Seller shall be deemed to be an independent contractor and its personnel and representatives shall not act as nor be Buyer's agents or employees. Seller shall have complete charge and responsibility for personnel employed or engaged by Seller.

18.3 Buyer may not assign any of its rights or obligations under this Agreement, including by purchase, merger or operation of law, without the prior written consent of Seller, which consent shall not be unreasonably withheld or delayed. Seller may assign this Agreement to any of its affiliates or any successor of all or substantially all of its business. Any attempted assignment or transfer in violation of this sub-Section 18.4 shall be null and void.

18.4 If any provision of this Agreement shall be held to be invalid, illegal, or unenforceable, the remaining terms of this Agreement shall in no way be affected or impaired.

Buyer Acceptance

See Addendum Attached Hereto

Signed Name

Company Name

Printed Name, Title

Date

Audio Visual Innovations Inc. and Signal Perfection Ltd are wholly owned subsidiaries of AVI-SPL, Inc. This Entire Document and all information (including drawings, specifications and designs) presented by any subsidiary are the property of AVI-SPL Inc. Proprietary information provided to potential customers, clients or agents is for the sole purpose of demonstrating solutions delivery capabilities and shall be held in confidence. These Materials may not be copied, distributed or disclosed in any way without the sole written permission of an authorized representative of AVI-SPL. © Copyright AVISPL. All Rights Reserved



Addendum to General Terms and Conditions – Software License

The following terms supplement and modify the General Terms and Conditions as they apply to Seller's provision of control system integration and programming as more particularly described in this Addendum and the Proposal. Any capitalized terms not otherwise defined herein shall have the meanings ascribed to them in the General Terms and Conditions.

1. License Grant and Ownership

1.1 Seller hereby grants to Buyer a worldwide, perpetual, non - exclusive, non - transferable license to all Software for its use in connection with the establishment, use, maintenance and modification of the control system implemented by Seller. The term "Software" for the purposes of this Software License shall refer to all source code, executable object code, and the patches, scripts, modifications, enhancements, designs, concepts or other materials that constitute the software programs necessary for the proper function and operation of the control system as delivered by Seller and accepted by Buyer.

1.2 Except as expressly set forth in this paragraph, Seller shall at all times own all intellectual property rights to the Software. Any and all licenses, product warranties or service contracts provided by third parties in connection with the Software or control system in which such Software is implemented shall be delivered to Buyer for the sole benefit of Buyer.

1.3 Buyer may supply to Seller or allow Seller to use certain proprietary information, including service marks, logos, graphics, software, documents and business information and plans that have been authored or pre-owned by Buyer. All such intellectual property shall remain the exclusive property of Buyer and shall not be used by Seller for any purposes other than those associated with delivery of the control system.

2. Copies, Modification and Use

2.1 Buyer may make copies of the Software solely for archival purposes and as required for modifications to the control system in which such Software is implemented. All copies and distribution of the Software shall remain within the direct control of Buyer and its representatives.

2.2 Buyer may make modifications to the source code version of the Software, if and only if the results of all such modifications are applied solely to the control system in which the Software is implemented. In no way does this Software License confer any right in Buyer to license, sublicense, sell, or otherwise authorize the use or distribution of the Software, whether in executable form, source code or otherwise, by any third parties, except in connection with the use of the control system for Buyer's internal business needs.

2.3 All express or implied warranties relating to the Software shall be deemed null and void in case of any modification to the Software made by any party other than Seller or Seller's authorized personnel.

3. Warranties and Representations

3.1 the Software and all intellectual property therein, are original to Seller or its third party licensors; and

3.2 the Software, as delivered by Seller as part of the control system, will not infringe or otherwise violate the intellectual property rights of any third party.

4. Indemnification

4.1 Seller hereby indemnifies and shall defend and hold harmless Buyer, its parent companies and its and their subsidiaries, affiliates, officers, directors, employees, agents and subcontractors from and against all liability, damages, loss, cost or expense, including but not limited to reasonable attorneys' fees and expenses, arising out of or in connection with any third party claims that the Software as delivered by Seller or any intellectual property therein infringes or otherwise violates any rights of any such third party. In no event will Seller have any obligations under this provision in the event such infringement results from (i) use of the Software or control system in which it is implemented in violation of this Software License, (ii) modification or alteration of the Software or the control system in which it is implemented by someone other than Seller or Seller's authorized personnel, (iii) content or specifications provided by Buyer, or (iv) use of the Software or control system in which it is implemented in combination with any other software, hardware, services or other materials other than as provided by Seller or authorized in the applicable manufacturer specifications.

4.2 Buyer hereby indemnifies and shall defend and hold harmless Seller, its parent companies and its and their subsidiaries, affiliates, officers, directors, employees, agents and third party licensors from and against all liability, damages, loss, cost or expense, including but not limited to reasonable attorneys' fees and expenses arising out of or in connection with any third party claims that Buyer's use of the Software in contravention of the grant of rights in this Software License infringes or otherwise violates any rights of any such third party.

4.3 Upon the assertion of any claim or the commencement of any suit or proceeding against an indemnitee, by any third party that may give rise to liability of an indemnitor hereunder, the indemnitee shall promptly notify the indemnitor of the existence of such a claim and shall give the indemnitor reasonable opportunity to defend and to settle the claim at its own expense and with counsel of its own selection. The indemnitee shall cooperate with the indemnitor, shall at all times have the full right to participate in such a defense at its own expense and shall not be obligated, against its consent, to participate in any settlement which it reasonably believes would have an adverse effect on its business.

5. Term and Termination

This Software License will automatically terminate upon the disassembly of the control system in which the Software is implemented, unless the control system is reassembled in its original configuration in another location. Seller may terminate this Software License upon notice for Buyer's failure to comply with any of the terms set forth in this Software License. Upon termination, Buyer is obligated to immediately destroy the Software, including all copies and modifications.

Audio Visual Innovations Inc. and Signal Perfection Ltd are wholly owned subsidiaries of AVI-SPL, Inc. This Entire Document and all information (including drawings, specifications and designs) presented by any subsidiary are the property of AVI-SPL Inc. Proprietary information provided to potential customers, clients or agents is for the sole purpose of demonstrating solutions delivery capabilities and shall be held in confidence. These Materials may not be copied, distributed or disclosed in any way without the sole written permission of an authorized representative of AVI-SPL. © Copyright AVISPL. All Rights Reserved



Addendum to General Terms and Conditions - Support and Maintenance Services

The following terms supplement and modify the General Terms and Conditions as they apply to Seller's provision of support and maintenance services as more particularly described in this Addendum and the Support and Maintenance Services Description (collectively, the "Services"). Any capitalized terms not otherwise defined herein shall have the meanings ascribed to them in the General Terms and Conditions.

1. Definitions

This Addendum contains defined terms and acronyms. The following definitions shall apply:

"Help Desk" means Seller's 24x7 global help desk as described in the Support and Maintenance Services Description and this Addendum;

"In-Warranty Hardware" means the covered equipment has an active, Manufacturer or third-party sponsored warranty program that can be exercised by the Buyer or by the Seller on behalf of the Buyer;

"Manufacturer" means an entity that produces hardware and / or software;

"Out-of-Warranty Hardware" means the covered equipment does not have an active, Manufacturer or third-party sponsored warranty program that can be exercised by the Buyer or by the Seller on behalf of the Buyer;

"Software Options" means optional functionality or features of software that may be selected at the time of purchase or later, and for which separate charges are assessed;

"Software Update" means software for which the Manufacturer has provided fixes or minor revisions to correct errors or defects in the existing operation of the software in accordance with the published product specifications, and which is limited to those updates that the Manufacturer generally provides to its customers at no charge. Software Updates do not include Software Upgrades or Software Options;

"Software Upgrade" means new releases of the software which contains enhancements improving the functionality or capabilities of the software, which Manufacturer may make available to its customers. Software Upgrades do not include Software Options; and

"Support and Maintenance Services Description" means that portion of the Proposal detailing the Services being purchased by Buyer.

2. Services Description

The Services purchased by Buyer are detailed in the Support and Maintenance Services Description.

3. Services Orders

Following Seller's order confirmation, Buyer agrees to provide a contact name, contact email address, and telephone number at the service location(s). Standard response times and service level agreements are not guaranteed until such information is received by the Help Desk.

Products specifically identified in the proposal will be eligible for Services. If Buyer elects to purchase any additional or optional services or features, additional fee(s) will be invoiced separately with payment terms as specified for such services.

4. Services Term

The Services shall commence upon installation project completion or, for Stand-alone

Services, upon Seller's confirmation of Buyer's order, and shall continue for the term specified in the Proposal, unless earlier terminated. Installation projects containing multiple phases or being performed over extended periods may include multiple completion milestones / service commencement dates. The Services shall expire at the conclusion of the term specified in the Proposal, unless earlier terminated. Notwithstanding anything to the contrary in the Terms and Conditions, Seller reserves the right to postpone commencement of the Services, upon written notice to Buyer, in the event of any delays that prevent Seller from commencing the Services on the original commencement date. In such case, Seller will provide a new Services commencement date and the term of the Services will commence as of that date and continue for the term specified in the Proposal, notwithstanding any specific dates contained in the Agreement or any other purchase documents. Invoicing and payment will be adjusted to align with the new commencement date of the Services.

5. Services Availability

Help Desk remote support is available on a 24x7 basis.

Unless otherwise noted in the Support and Maintenance Services Description, the Seller's field service technicians are available Monday through Friday from 8 AM to 5 PM local standard time, excluding legal holidays. For Buyers with service locations in the United Arab Emirates, the Seller's field service technicians are available Sunday through Thursday from 8 AM to 5 PM local standard time, excluding legal holidays.

Requirements to provide Services prior to or after the agreed upon hours of support must be agreed to by both Parties in advance and in writing and additional fees may apply.

6. Third Party Services

Seller may make third party services available to Buyer. Seller offers no guarantees and assumes no responsibility or liability of any kind with respect to third party services.

7. Software Updates, Upgrades, and Options

The Help Desk will assist with the provision of Software Updates, Upgrades, or Options when necessary to resolve a reported issue and when made available by the Buyer or Manufacturer. Depending on Services elected, additional charges may apply for proactive management of Software Updates, Upgrades, or Options and when specialist or onsite support of these activities is requested or required. Seller will not be liable for any issues, damages or disruption arising from a Software Update, Upgrade, or Option released by a third party.

8. Replacement Parts

Standard program: In-Warranty Hardware will be eligible for repairs or replacement parts and the use of advanced replacement programs in accordance with the Manufacturer's published warranty program.

Replaced parts will become the property of Seller or the Manufacturer. If replacement activity is performed by Buyer, the replaced parts must be returned per the Seller's

Audio Visual Innovations Inc. and Signal Perfection Ltd are wholly owned subsidiaries of AVI-SPL, Inc. This Entire Document and all information (including drawings, specifications and designs) presented by any subsidiary are the property of AVI-SPL Inc. Proprietary information provided to potential customers, clients or agents is for the sole purpose of demonstrating solutions delivery capabilities and shall be held in confidence. These Materials may not be copied, distributed or disclosed in any way without the sole written permission of an authorized representative of AVI-SPL. © Copyright AVISPL. All Rights Reserved



direction within five (5) business days of receipt of the replacement part; otherwise, Buyer will be invoiced the full list price for the replaced part.

Depending on Services elected, additional charges may apply for onsite support of In-Warranty Hardware parts repair or replacement. Out-of-Warranty Hardware or other parts repair or replacement deemed to be out-of-warranty will be considered billable activity.

Optional program: Buyers who elect an extended hardware warranty as a component of their Services are eligible for repairs or replacement parts for Out-of-Warranty Hardware. The inclusion of this coverage must be incorporated into the Support and Maintenance Services Description and is further described therein.

9. Service Level Agreement

Help Desk response: Seller's Help Desk will provide an average speed of answer of sixty (60) seconds for support calls and will respond to new service requests made via email or web portal to its Help Desk within four (4) hours with case assignment notification.

Upon the Help Desk's determination that a dispatch is required, Seller's field service technicians will provide the onsite response aligned to the service level elected in the Support and Maintenance Services Description. The ability to meet this service level may be impacted by the Buyer's room availability, the requirement for replacement parts, and the reliance on a Buyer's third-party.

When a case is opened, the Help Desk will classify the case in accordance with the following incident priority classifications:

Priority 1 – core business or technology functionality unavailable resulting in work stoppage or significant impact to user experience

Priority 2 – a loss in functionality that compromises but does not prevent work completion or have significant impact to user experience

Priority 3 – issue that does not compromise work completion and therefore does not require immediate attention

Priority 4 – issue that can be scheduled such as a maintenance activity or scheduled replacement

10. Services Exclusions

Unless otherwise specified in the Support and Maintenance Services Description, Services do not cover any of the following: (i) electrical work and / or in-house cabling; (ii) repair or replacement resulting from natural disaster, fire, accident, neglect, misuse, vandalism, water, corrosion, power surges, unconditioned or fluctuating power, Buyer-provided network, or failure of the installation site to conform to Manufacturer specifications; or resulting from use other than intended purposes; or resulting from use with items not provided or approved by Seller; or resulting from the performance of maintenance or the attempted repair by persons other than Seller's employees or persons authorized by Seller; (iii) repair or replacement excluded by or no longer covered by the Manufacturer's repair and replacement program; (iv) furnishing supplies or accessories including consumables such as projection lamps, bulbs, filters, fuses, batteries and the labor to replace these items; (v) relocation services, or the addition or removal of items from or to other devices not furnished by Seller; (vi) damage to displays caused by screen burnout or image "burn-in"; and (vii) Services in connection with computer viruses or conflicts involving software that is not installed or introduced by Seller including coverage for Buyer-furnished product unless specifically listed as covered product.

Any modifications and / or additions made without Seller's prior written approval are at Buyer's sole risk and expense. If, in Seller's reasonable discretion, such modifications and / or additions cause defects, disruptions and / or malfunction, and Buyer requests Seller's assistance to correct the issue, Seller's assistance will be billable at Seller's then-current time and material rates.

11. Charges and Payment Terms

Unless otherwise specified in the Proposal, payment terms are net 30 days from Buyer's receipt of invoice. Unless otherwise specified in the Proposal, Stand-alone Services will be billed upon Seller's confirmation of Buyer's order. Any services provided that are not included in the Services will be billable as incurred.

12. Termination

Seller may immediately terminate the Services upon written notice in whole or in part for cause if any person other than a Seller employee or designated service representative alters covered equipment rendering it unsafe.

In the event of Buyer's early termination for cause, a pro-rated refund will be issued to the Buyer for the unused term of Services, except Buyer shall remain liable for (i) all non-refundable third-party fees incurred by Seller for prepaid expenses and (ii) all services performed during Services term. Services may not be terminated for convenience.

Seller reserves the right to terminate or modify available Services at any time in its sole discretion; provided, however, that any such termination or modifications will not affect any Services already ordered by Buyer and confirmed by Seller prior to such termination or modifications except as mutually agreed by both Parties.

13. Buyer Obligations

(a) Buyer shall provide Seller with all information, cooperation and access that Seller reasonably requests for remote diagnosis of the reported issue. Parts replacement and onsite service may not become available until the Help Desk is provided the appropriate information or support to diagnose the issue.

(b) If applicable, Buyer shall provide Seller personnel with timely access to service location and adequate working space at no charge to Seller.

(c) Buyer shall provide Seller's onsite managed services personnel with adequate working conditions that comply with all applicable labor, safety and health laws and regulations.

(d) Buyer will provide the necessary utility services for use in accordance with the Manufacturer's applicable published specifications.

(e) Buyer will be responsible for payment of parts and services provided by Seller that are not covered by the Services. Seller will obtain Buyer's written consent prior to providing the parts and / or services, which will be billable at Seller's then-current time and material rates.

(f) Seller strongly recommends that Buyer install and use a current, reputable anti-virus program in connection with any PC-based, open-architecture product, and that Buyer regularly updates and runs such anti-virus program, especially in connection with the emergence of any new viruses.

(g) Buyer is solely responsible for backing up its data. Seller will not under any circumstances have a duty to back up Buyer's data or to restore data that is lost in the course of Seller's provision of Services, or otherwise. ~~Seller will not be liable for the~~

Audio Visual Innovations Inc. and Signal Perfection Ltd are wholly owned subsidiaries of AVI-SPL, Inc. This Entire Document and all information (including drawings, specifications and designs) presented by any subsidiary are the property of AVI-SPL Inc. Proprietary information provided to potential customers, clients or agents is for the sole purpose of demonstrating solutions delivery capabilities and shall be held in confidence. These Materials may not be copied, distributed or disclosed in any way without the sole written permission of an authorized representative of AVI-SPL. © Copyright AVISPL. All Rights Reserved



~~loss of Buyer's data, whatever the reason for the loss, including without limitation as a result of Seller's negligence. The preceding limitation applies to any cause of action, whether based in contract, tort, or any other theory.~~

14. Solicitation

At no time during the term of the Services or for one (1) year thereafter, will Buyer directly or indirectly offer employment to any Seller employees who performs Services on behalf of Seller without Seller's express prior written consent. ~~In the event that Buyer is in breach of this provision, Seller shall have the right to invoice Buyer and Buyer agrees to pay a sum equal to twelve (12) months' salary in respect of the hired individual.~~ The foregoing restrictions shall not apply to solicitation through any general recruitment advertisement in the normal course of business, without specifically targeting or approaching the other Seller's employees.

15. Warranty and Limitation of Liability

SELLER WARRANTS FOR NINETY (90) DAYS FROM THE PERFORMANCE OF ANY SERVICES HEREUNDER THAT SUCH SERVICES SHALL BE PERFORMED IN A WORKMANLIKE MANNER CONSISTENT WITH GENERALLY ACCEPTED INDUSTRY STANDARDS. SELLER MAKES NO OTHER WARRANTY, EITHER EXPRESS OR IMPLIED, INCLUDING, BUT NOT LIMITED TO, ANY WARRANTY OF FITNESS FOR A PARTICULAR PURPOSE OR OF MERCHANTABILITY. SELLER MAKES NO WARRANTY THAT OPERATION OF THE PRODUCT SERVICED WILL BE UNINTERRUPTED OR ERROR FREE. BUYER MUST PROMPTLY REPORT IN WRITING ANY BREACH OF THIS WARRANTY TO SELLER NO LATER THAN FIFTEEN (15) DAYS AFTER EXPIRATION OF THE ABOVE WARRANTY PERIOD, AND BUYER'S EXCLUSIVE REMEDY AND SELLER'S ENTIRE LIABILITY FOR ANY BREACH OF SUCH WARRANTY SHALL BE FOR SELLER TO RE-PERFORM THE SERVICES OR, IF SELLER IS UNABLE TO RE-PERFORM THE SERVICES AS WARRANTED, BUYER SHALL BE ENTITLED TO RECOVER THE PRORATED FEES PAID TO SELLER FOR THE NONCONFORMING SERVICES. ~~SUBJECT TO THE EXCLUSION OF DAMAGES PROVISION CONTAINED IN THE GENERAL TERMS AND CONDITIONS, SELLER'S MAXIMUM LIABILITY FOR ALL OTHER DAMAGES WILL BE LIMITED TO ONE (1) YEAR'S SERVICE CHARGES.~~ THIS LIMITATION OF LIABILITY IS CUMULATIVE AND NOT PER INCIDENT. SOME STATES OR JURISDICTIONS DO NOT ALLOW THE EXCLUSION OR LIMITATION OF INCIDENTAL OR CONSEQUENTIAL DAMAGES AND IN SUCH EVENT, THE FOREGOING EXCLUSIONS AND LIMITATIONS SHALL ONLY APPLY TO THE EXTENT PERMITTED BY APPLICABLE LAW.

[remainder of page intentionally left blank]

Audio Visual Innovations Inc. and Signal Perfection Ltd are wholly owned subsidiaries of AVI-SPL, Inc. This Entire Document and all information (including drawings, specifications and designs) presented by any subsidiary are the property of AVI-SPL Inc. Proprietary information provided to potential customers, clients or agents is for the sole purpose of demonstrating solutions delivery capabilities and shall be held in confidence. These Materials may not be copied, distributed or disclosed in any way without the sole written permission of an authorized representative of AVI-SPL. © Copyright AVISPL. All Rights Reserved



Town of Surfside – Conferencing AV Upgrade

AUDIO VISUAL UPGRADE STATEMENT OF WORK

Objective

The current AV systems at the Council Chambers at the Town of Surfside required AV Technology upgrades in support of soft conferencing. The goal of this AV upgrade is to bring the AV technology of this space to the latest digital industry standards and trends while preserving (but modernizing) the established workflow. This will be accomplished by providing technology that is powerful, flexible but easy to use for an untrained end-user. Every attempt has been taken to keep project expenses low as much as possible without compromising the delivery of high-quality video signals, enhanced audio signals and a reliable control systems implementation.

General Notes

1. Work shall be done during the regular business hours.
2. Town of Surfside (in further text referred to as "Client"), shall be responsible for all of the high voltage electrical connections, LAN drops, millwork, wall repairs including patching, painting and any required structural support for the new AV equipment being installed.
3. Client shall provide free parking near the facility for all AVI-SPL vehicles.
4. AVI-SPL shall inspect and clean the existing AV equipment that is being repurposed during the installation.
5. All equipment being reused in this project shall carry on AVI-SPL warranty. If any piece of the existing equipment fails during the installation or commissioning phase, AVI-SPL shall provide a written proposal via change order form at that time.
6. Standard ground freight is included. Any requests by Client to expedite delivery of the AV equipment shall result in change order form at AVI-SPL's discretion.
7. Permitting fees and any project management hours associated with the low voltage permits with the local municipality are not included and shall result in the change order form prior execution.
8. Client is responsible for providing a dust free environment prior to the installation of all technology equipment. Proper schedule coordination is required between the client and the project manager to ensure this is the case.
9. Current scope does not include the removal of existent equipment from the existent space. If required, that can be added as a modification to the existent proposal.
10. Wherever possible, existing wiring shall be repurposed (microphones, speakers, twisted pair and control wire).
11. All wires and cables, existing and new, shall be clearly labeled with new self-adhesive printed labels in accordance with provided cable pull schedule and labeling legend as referenced in the drawings.
12. Client shall allow AVI-SPL crew members easy uninterrupted access to the jobsite. Job site shall not be usable for the duration of the new audio-visual system implementation and commissioning.
13. AVI-SPL shall supply a network sheet with MAC addresses of all the equipment on the client network so that said equipment can be white-listed on the Client LAN.
14. Upon project completion, AVI-SPL shall provide 2-hour training to Client's AV/IT staff as well as full project folder containing "as-build" drawings, rack elevations, warranty statement, wire and cable labeling legend, all relevant project documents and equipment manuals, Help Desk information and uncompiled Processor / DSP source codes, in electronic format via download.

Council Chambers

Conferencing System

AV conferencing equipment will be installed in this space to support open UC conferencing using a client-provided computer.

By design, the OFE conferencing computer will have one USB audio input and one USB video input in support of soft codec-based conferencing. The Video USB connection will be created via one (1) SDI to USB adapter. The Audio USB connection for far-end audio will be done through one (1) USB network adapter. Near-end audio for the far-end will be embedded onto the SDI upstream of computer capture via a SDI audio embedder.

Each soft codec application installed on the OFE PC shall require a one-time setup for the selection of the connected USB resource (video and audio) and this task shall be done by the Client's AV staff. USB 3.0 video connections are not supported in this design and would require a specific extender, that can be provided through a modification to this proposal.

The Client is responsible for providing system credentials for a properly provisioned and licensed account no less than two (2) weeks prior to system deployment. The client may decide not to provide credentials to AVI-SPL, and to provision the installed Zoom Room themselves. In this case AVI-SPL will be unable to fully test the system before receiving sign-off for the installation. All system components will be tested individually to ensure proper stand-alone function, and project sign-off will be requested before technicians leave site. If AVI-SPL is unable to properly commission and test the system at the time of installation due to issues with the supplied credentials, an additional site visit may be required. Any additional visits will be billed at the standard contracted labor rate, and scheduling will be done on a best effort basis. The client is responsible for providing and provisioning all network connections, routing, and addressing. The client is responsible for all aspects of the network connection supplied for the Zoom Room deployment. The client should test the network prior to system deployment by utilizing, <https://www.zoom.us/test>. Firewall and additional port configuration should be done to allow access to the Zoom cloud service as defined by Zoom, <https://support.zoom.us/hc/en-us/articles/201362683>. Network Quality of Service (QoS) and/or Differentiated Services (DiffServ) tagging should be set, if desired.

Room Audio

AVI SPL will modify the existent digital signal processor (DSP) to support soft conferencing. The DSP will handle all audio related tasks including equalization, signal compression, routing and processing as required. As it relates to conferencing:

- Sources to include:
 - Room Microphones
 - Program Content
- Outputs to include:
 - Speakers Feeds
 - Feed to OFE PC Computer (via USB)

DSP Canvas interface will be updated to add control for far-end audio to the local room.

There are several factors outside of the equipment in the classroom that can make audio/video conferencing or recording to have decreased intelligibility in a room, among them are: far-end participant's equipment, telephony and network infrastructure and the unique acoustic properties of the room. If the room acoustics are found to be inhospitable to audio for conferencing (due to reflective surfaces or ambient noise), acoustical treatments will be suggested or in extreme cases a consultation with a qualified acoustician may be in order.



Control System and Client Network

Existent control system will be updated in support of new Zoom Conferencing system.

The AV equipment is LAN based and will live on the client network. The functionality of all devices is dependent on the reliability of the client LAN. The client LAN is assumed to be configured per industry-best practices and assumed to offer POE+ to endpoints. To ensure optimum operation of the system, it is recommended that the client IT staff provides a static IP range that the commission staff can use to do static IP reservations of all gear. At the end of the project a comprehensive network sheet shall be supplied containing the static IP assignment and a MAC address for each product. If the client opts for doing DHCP reservations then they will be responsible for having an IT staff member available during the commissioning process to promptly assist with the connection of all AV endpoints on the network. Failure to provide prompt IP addressing support or failure to reserve MAC addresses may result in additional work that will be forwarded to the client in the form of a change order.

A standalone AV network is not provided in this design and would require additional hardware, that can be provided through a modification to this proposal.

AudioVisual Solutions Proposal For

TOWN OF SURFSIDE

Close Captioning

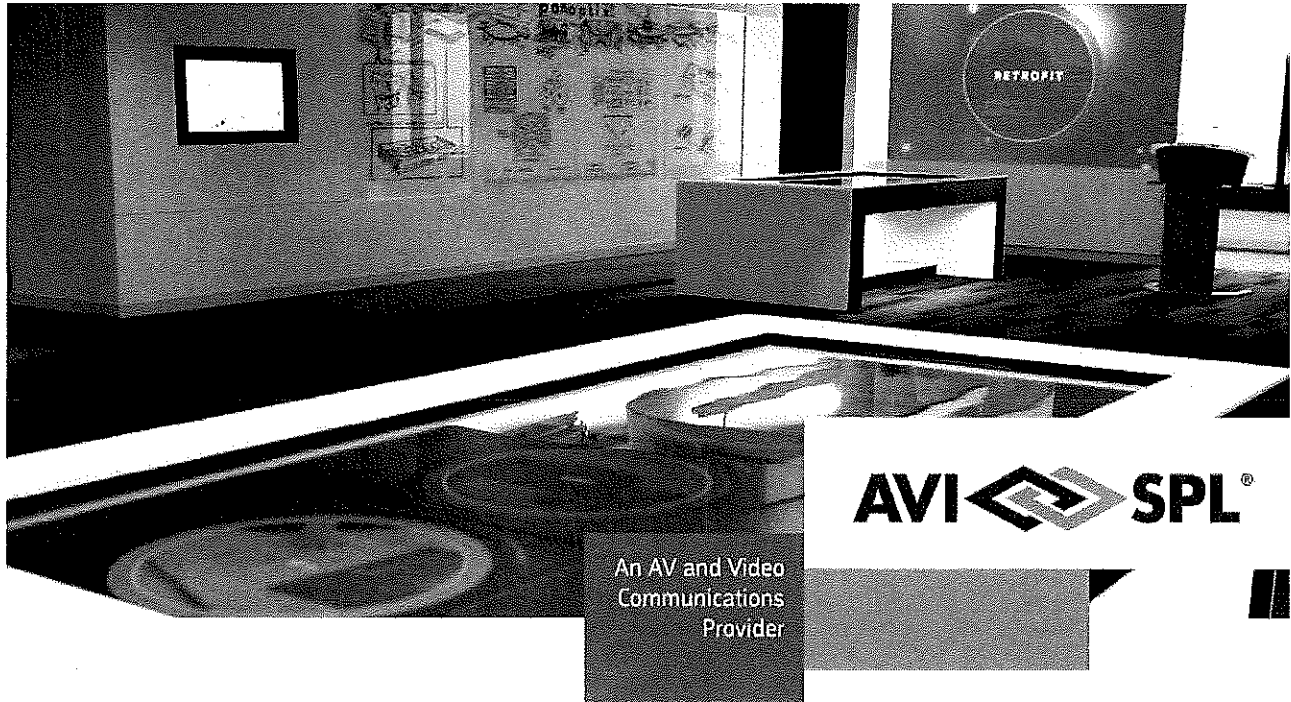

AVI  **SPL**®

An AV and Video
Communications
Provider

AVI  **SPL**®

Audio Visual Innovations, Inc. - A wholly owned subsidiary of AVI-SPL, Inc.

772 South Military Trail
Deerfield Beach, FL 33442
(954) 938-9382
Fax: (954) 776-4772
www.avispl.com

Prepared By: Debra Blanco
Debra.Blanco@avispl.com

Proposal No: 302282-1, CR-005



Investment Summary

Prepared For:	JOSE FELIZ
	TOWN OF SURFSIDE
	9293 Harding Ave
	Surfside, FL 33154-3000

Prepared By:	Debra Blanco
Date Prepared:	02/25/2020
Proposal #:	302282-1, CR-005
Valid Until:	04/26/2020

Total Equipment Cost **\$43,695.00**

Includes cable, connectors, hardware, switches, relays, terminal blocks, panels, etc., to ensure a complete and operational system

Professional Integration Services **\$5,400.00**

Includes: Engineering, project management, CAD, on-site installation and wiring, coordination and supervision, testing, checkout, owner training, etc. performed on the Owner's premises. Also includes all fabrication, modification, assembly, rack wiring, programming, warranties, etc., some performed at AVI-SPL

Direct Costs **\$0.00**

Includes: Non equipment or labor costs such as travel expenses, per diem, lift and vehicle rentals.

General & Administrative **\$1,224.23**

Includes all G & A expenses: bonds, vehicle mileage, shipping & insurance

Maintenance Services **\$0.00**

Includes room maintenance services and/or customer care hardware and software maintenance services as described in "Room Summary".

Subtotal	\$50,319.23
Tax	Exempt (*)
Total	\$50,319.23

* Exemption from sales tax will be recognized only after a valid sales tax exemption certificate or other appropriate documentation of exemption has been provided to and approved by AVI-SPL; otherwise all applicable sales taxes will apply.

Purchase orders should be addressed to Audio Visual Innovations, Inc.

Signed _____

Printed _____

Date _____

See Addendum Attached Hereto

Audio Visual Innovations Inc. and Signal Perfection Ltd are wholly owned subsidiaries of AVI-SPL, Inc. This Entire Document and all information (including drawings, specifications and designs) presented by any subsidiary are the property of AVI-SPL Inc. Proprietary information provided to potential customers, clients or agents is for the sole purpose of demonstrating solutions delivery capabilities and shall be held in confidence. These Materials may not be copied, distributed or disclosed in any way without the sole written permission of an authorized representative of AVI-SPL. © Copyright AVI-SPL. All Rights Reserved



Room Summary

Prepared For:	JOSE FELIZ
	TOWN OF SURFSIDE
	9293 Harding Ave
	Surfside, FL 33154-3000

Prepared By:	Debra Blanco
Date Prepared:	02/25/2020
Proposal #:	302282-1, CR-005
Room Name:	First Room
Valid Until:	04/26/2020

Equipment List

Mfg	Model	Description	Qty	Unit Price	Extended Price
		<u>EEG Product Credit</u>			
EEG ENTERPRISES, INC.	EEGHD492	ENCODER/DECODER VII, HDTV SMART 1 YEAR SUPPORT& 2 YEAR HARDWARE WARRANTY INCLUDED	-1	\$9,090.00	(\$9,090.00)
		<u>ENCO Gear</u>			
ENCO	EEGENCAPTION	ENCAPTION ENCODER INCLUDING INITIAL SETUP AND CONFIGURATION	1	\$47,790.00	\$47,790.00
ENCO	EEGCCENCODECARD	CLOSED CAPTION ENCODER CARD	1	\$4,995.00	\$4,995.00
Total					\$43,695.00

Room Maintenance Services

	Price
90 Day - Warranty	\$0.00
Equipment Total	\$43,695.00
Installation Materials	\$0.00
Professional Services	\$5,400.00
Direct Costs	\$0.00
General & Administrative	\$1,224.23
Maintenance Services	\$0.00
Subtotal	\$50,319.23
Tax	Exempt
Total	\$50,319.23

Purchase orders should be addressed to Audio Visual Innovations, Inc.

Audio Visual Innovations Inc. and Signal Perfection Ltd are wholly owned subsidiaries of AVI-SPL, Inc. This Entire Document and all information (including drawings, specifications and designs) presented by any subsidiary are the property of AVI-SPL Inc. Proprietary information provided to potential customers, clients or agents is for the sole purpose of demonstrating solutions delivery capabilities and shall be held in confidence. These Materials may not be copied, distributed or disclosed in any way without the sole written permission of an authorized representative of AVI-SPL. © Copyright AVI-SPL. All Rights Reserved
 AVI-SPL, Inc. Proposal #: 302282-1, CR-005 / Job #: 0301-19-74356

AudioVisual Solutions Proposal For

TOWN OF SURFSIDE

Annual Support For Enco Product

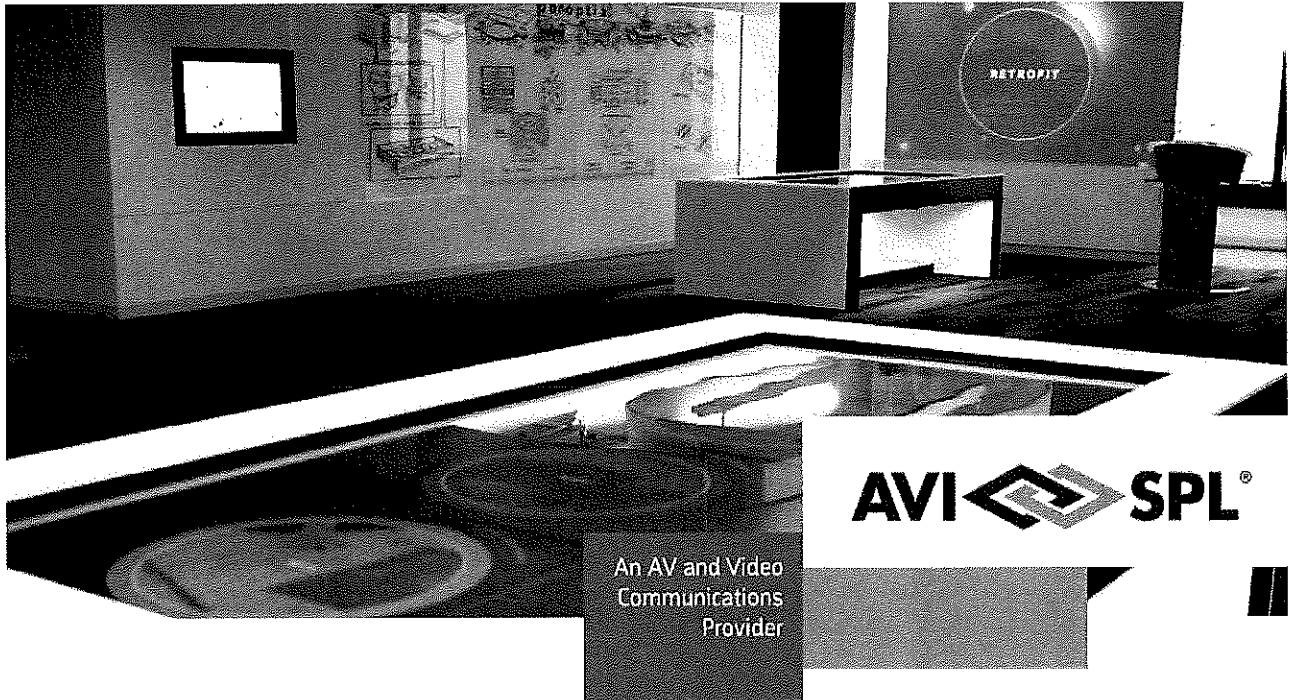

Audio Visual Innovations, Inc. - A wholly owned subsidiary of AVI-SPL, Inc.

772 South Military Trail
Deerfield Beach, FL 33442
(954) 938-9382
Fax: (954) 776-4772
www.avispl.com

Prepared By: Debra Blanco
Debra.Blanco@avispl.com

Proposal No: 332393-2



The AVI-SPL Process

AVI-SPL has developed a comprehensive integration process designed to meet our customer expectations. Our process begins with system design and carries through to post-installation training to ensure technology adoption. Our goal at AVI-SPL is to work with you every step of the way to ensure that your project is completed within scope, on schedule and within budget.

Proposal and Systems Design

AVI-SPL will conduct an initial detailed consultation and needs analysis with key customer stakeholders to gain a thorough understanding of needs, objectives and success criteria. This information is used to develop a proposed system solution for acceptance. This step provides Account Management and applicable Engineering Design support the ability to design a technically sound and functional solution where we will:

- Verify initial design concepts through examination of the desired capabilities, architectural and environmental considerations.
- Define scope of work criteria.
- Select the appropriate equipment, hardware and software to allow system design performance.
- Provide any value engineering and performance enhancement recommendations.

The result of the proposal and systems design phase is a system designed specifically to meet the requirements that are unique to your application.

AVI-SPL Project Delivery Process Flow

Upon award, the project is turned over to the AVI-SPL Project Integration Team. This phase is critical in ensuring a seamless integration of the specified system. During project delivery, the AVI-SPL System Integration (SIG) Operations Workflow contains distinct process steps start to finish upon award as noted below.

During project delivery AVI-SPL will (as applicable to the specific project):

- Complete internal and external kick off requirements to review:
 - Scope of Work and Design
 - Contract Parameters, including Terms and Conditions
 - Stakeholder Reporting and Communication
 - Schedule (including all WBS project tasks and timelines)
 - Submittal requirements
 - Procurement Plan
 - Risk Identifiers
 - Site Safety and Security
 - Change Management Procedures
 - Acceptance Test Plan Parameters
- Create all final construction/field coordination requirements including:
 - Floor, reflected ceiling, riser diagrams and furniture requirements.
 - AV Design drawings including audio/video/control signal flow and equipment rack elevations.
- Provide a user interface design requiring client sign off; this is a critical project success factor without it additional charges may apply.
- Create the source code for the system based on the design as agreed upon.
- Test and Commission AV systems in AVI-SPL shop, based upon acceptance test plan parameters.

Audio Visual Innovations Inc. and Signal Perfection Ltd are wholly owned subsidiaries of AVI-SPL, Inc. This Entire Document and all information (including drawings, specifications and designs) presented by any subsidiary are the property of AVI-SPL Inc. Proprietary information provided to potential customers, clients or agents is for the sole purpose of demonstrating solutions delivery capabilities and shall be held in confidence. These Materials may not be copied, distributed or disclosed in any way without the sole written permission of an authorized representative of AVI-SPL. © Copyright AVI-SPL. All Rights Reserved



- Complete all field installation of cable and equipment, based on project scope and schedule requirements.
- Test and Commission the completed system in the field, based upon acceptance test plan parameters.
- Document and address any punch list items, upon client inspection, following final commissioning.
- Demonstrate full operation of the system to the Customer and train the Customer support staff on the proper use, care and basic troubleshooting of the systems provided.
- Provide final close out (as-built) documentation including:
 - As-Built Drawings
 - Final Acceptance Test Plan Document
 - Programming Source Code
 - Project Serial Numbers and Equipment information
- Acquire the applicable sign off on system for final invoicing and start of the applicable service term.

During project delivery the Customer will:

- Adhere to any client required tasks/milestones as noted in the agreed to project schedule.
- Coordinate with AVI-SPL regarding any network requirements and information.
- Provide any and all the Customer logos and specific color requirements for the control system user interface.
- Sign-off on the user interface design.
- Upon completion of the system installation and testing, inspect the system and provide conditional and/or final acceptance of the system, based upon the agreed upon scope of work.
- Provide final sign off of the system upon completion.

Project Coordination and Site Installation:

AVI-SPL will designate a Project Manager, who will be the main contact for directing and managing all project coordination with all project stakeholders; both externally and internal to the AVI-SPL project team.

The AVI-SPL Project Manager is responsible for attending project calls/ meetings for the project duration and consistent communication. AVI-SPL is committed to keeping you informed from the beginning to the end of your project. Initial communication will include contact information and organization of the AVI-SPL team that will be working with you. Shortly thereafter, you will begin receiving project status reports from the technical project team member responsible for routine contact throughout the entire project.

The onsite installation effort is coordinated by the Project Manager and Lead Installer. The Lead Installer will be on site directing the installation teams. Prior to delivery and installation of pre-assembled systems, AVI-SPL will field verify conformance of installed cabling and other conditions necessary to assure efficient integration of systems and devices. The Project Manager will determine the correct resources required for the specific installation tasks. In cases where AVI-SPL will utilize vetted and approved subcontractors on the project, the Project Manager and Lead Install provides proper supervision to ensure policies and procedures are being adhered to.

All installation work is thoroughly checked prior to 'turn on'. Errors or problems are corrected as detected and all equipment is adjusted for optimal performance in accord with the project specifications. By adhering to strict engineering policies and standards, the final punch list for projects of this type is typically limited to just a few items.

- Adherence to our quality assurance program.
- Installation of fully tested and "burned in" electronic hardware.
- Termination into fully tested and verified cabling and far end connections.

Audio Visual Innovations Inc. and Signal Perfection Ltd are wholly owned subsidiaries of AVI-SPL, Inc. This Entire Document and all information (including drawings, specifications and designs) presented by any subsidiary are the property of AVI-SPL Inc. Proprietary information provided to potential customers, clients or agents is for the sole purpose of demonstrating solutions delivery capabilities and shall be held in confidence. These Materials may not be copied, distributed or disclosed in any way without the sole written permission of an authorized representative of AVI-SPL. © Copyright AVI-SPL. All Rights Reserved



- Correcting site specific problems as they are detected.

The Customer shall provide an environment that is 'clean and ready' to receive the equipment and services described herein. The environment shall be secure and free of dust, debris and conditions that might prove detrimental to the equipment provided or personnel on site.

Customer required or provided items (Owner Furnished Equipment - "OFE") and client required scope are detailed in this proposal. Any charges for return trips required of AVI-SPL based on insufficient or incomplete client milestones/deliverables will be the responsibility of the Customer.

The Customer must provide an internal IT contact to assist with any network coordination where required.

Change Management

The AVI-SPL change management process provides a mechanism for changes to the agreed upon scope of work of the project. Change requests can be initiated by authorized client requestors to the Project Manager of record at any time. Unless otherwise indicated, the AVI-SPL Change Management Process includes the following stages:

- Client requests a specific change
- AVI-SPL reviews change request compared to approved Scope of Work for potential impact of:
 - Budget
 - Schedule / Time
 - Programming / Function
- AVI-SPL provides written change order response / proposal
- Client executes approval of proposed change order
 - A formal change to contract / purchase order (if applicable) required.
- AVI-SPL proceeds with applicable performance requirements of change order (equipment order, resource time and appropriate scheduling)

All change requests must be made in writing or discussed with the Project Manager of record by the Customer (or client representative with authority to approve changes of agreed upon scope of work) for review and impact considerations. Written authorization to proceed, which may include formal changes to the contract or purchase order, must be provided to AVI-SPL prior to the release of any resources, time or equipment acquisition for a requested change order.

Project Managers may also leverage the change management process to notify the Customer of necessary change in system components or design if required.

Training, System Turnover and Project Completion

An integral part of the delivered system is user training. AVI-SPL is committed to providing you with clear and concise instructions on the use of each system. Training and associated documentation will provide operational and maintenance personnel with information to support the daily use of the system. This training will consist of demonstration, instruction and hands-on experience with each system.

System Turnover will occur when all user training has been completed and the users have obtained beneficial use of the systems. At this point, AVI-SPL will request client sign off on the provided systems. Conditional Project Sign-Off will apply if outstanding punch list items exist. AVI-SPL will set forth a plan to address these items accordingly.

Project Completion will occur when all outstanding punch list items are complete and all As-Built documentation has been provided to the Customer in the decided upon delivery method including; Project drawings, functional system diagrams, applicable equipment lists, back up control system and DSP code. At this time, Final Project Sign-Off will be requested.

Audio Visual Innovations Inc. and Signal Perfection Ltd are wholly owned subsidiaries of AVI-SPL, Inc. This Entire Document and all information (including drawings, specifications and designs) presented by any subsidiary are the property of AVI-SPL Inc. Proprietary information provided to potential customers, clients or agents is for the sole purpose of demonstrating solutions delivery capabilities and shall be held in confidence. These Materials may not be copied, distributed or disclosed in any way without the sole written permission of an authorized representative of AVI-SPL. © Copyright AVI-SPL. All Rights Reserved



AVI-SPL Support and Maintenance Offering Overview

AVI-SPL's Global Support offerings provide world class services designed to help you achieve the most uptime and the best Return on Investment (ROI) from your technology investment. We utilize our 40 years of experience with 700+ manufacturer technologies to become the service partner you can count on.

	Essential (T&M)	Enhanced	Elite
Unlimited Remote Help Desk, 24x7		●	●
Unlimited Onsite Support, 8x5			●
In Manufacturer-Warranty Hardware Support	●	●	●

Support Services are provided on a per-room or per-project basis.

Essential (Time & Materials)

Full suite of Global Support offerings available in a noncontract form, all billable at standard AVI-SPL rates (See rate table).

Billable Offerings:

- Remote Help Desk, 24x7
- Onsite Technical Dispatch
- Specialist Remote Support
- Parts Repair and Replacement

Enhanced

- Offers unlimited remote help desk support – available 24x7x365.
- Facilitates the repair or replacement of manufacturer programs for applicable hardware.
- Access to software updates and upgrades for hardware covered by manufacturer program.
- Use of online incident reporting tool for easy ticket awareness.
- Eligibility for discounted hourly rates when other Global Support services not included in the Enhanced offering are requested.

Elite

- Offers unlimited onsite technical dispatch.
- Offers unlimited remote help desk support – available 24x7x365.
- Facilitates and performs the repair or replacement programs of manufacturer programs for applicable hardware.
- Access to software updates and upgrades for hardware covered by manufacturer program.
- Use of online incident reporting tool for easy ticket awareness.
- Eligibility for discounted hourly rates when other Global Support services not included in the Elite offering are requested.

Audio Visual Innovations Inc. and Signal Perfection Ltd are wholly owned subsidiaries of AVI-SPL, Inc. This Entire Document and all information (including drawings, specifications and designs) presented by any subsidiary are the property of AVI-SPL Inc. Proprietary information provided to potential customers, clients or agents is for the sole purpose of demonstrating solutions delivery capabilities and shall be held in confidence. These Materials may not be copied, distributed or disclosed in any way without the sole written permission of an authorized representative of AVI-SPL. © Copyright AVI-SPL. All Rights Reserved



AVI-SPL Global Support Plus Options

PLUS Options are available at an additional cost.

Our Global Support Plus Options are additions to the Global Support, customized to your unique environment. PLUS Options allow us to take on more of the risk associated with aging equipment, help prevent unexpected expenses, and provide an enhanced onsite response time to get spaces up and running. Add one or multiple options to enable the flexibility needed.

PLUS Offerings

Extended Hardware Warranty	Corrective Maintenance Visit
Enhanced Onsite Response: 4 Hour or Next Business Day*	Loaner Equipment
Preventative Maintenance Visit	Consumable Replacement
<p>Extended Hardware Warranty We cover repair or replacement cost of malfunctioning equipment. Unforeseen expenses drop significantly as we assume the risk of replacement parts of aging equipment.</p> <p><small>*Owner Furnished Equipment not Included</small></p>	<p>Corrective Maintenance Visit Onsite maintenance visits that can be purchased up-front and scheduled after a fault has been found to resolve a hardware or software issue and bring the room back to operating specifications.</p>
<p>Enhanced Onsite Response Optional Next Business Day or 4 Hour onsite response (each purchased separately) provide the fastest response possible to keep mission critical situations from escalating.</p> <p><small>*Not available in all areas. Subject to AVI-SPL approval</small></p>	<p>Loaner Equipment We reduce down time by keeping rooms fully functional while a final repair is executed. We provide a functionally equivalent piece of equipment.</p> <p><small>*Not available in all areas. Subject to AVI-SPL approval</small></p>
<p>Preventative Maintenance Check Discover a potential issue before a meeting. Onsite visits that work around scheduled use of space to ensure equipment is kept in optimal operating conditions. Onsite technicians complete a standard checklist, and make recommendations to enhance reliability, features, and security.</p>	<p>Consumable Replacement Proper maintenance is essential to ensuring equipment reaches it maximum lifespan. Mitigate unknown expenses by including high-volume points of failure (examples include: lamps, bulbs, filters, fuses, batteries).</p> <p><small>*Not available in all areas. Subject to AVI-SPL approval</small></p>

Audio Visual Innovations Inc. and Signal Perfection Ltd are wholly owned subsidiaries of AVI-SPL, Inc. This Entire Document and all information (including drawings, specifications and designs) presented by any subsidiary are the property of AVI-SPL Inc. Proprietary information provided to potential customers, clients or agents is for the sole purpose of demonstrating solutions delivery capabilities and shall be held in confidence. These Materials may not be copied, distributed or disclosed in any way without the sole written permission of an authorized representative of AVI-SPL. © Copyright AVI-SPL All Rights Reserved



Investment Summary

Prepared For:	JOSE FELIZ
	TOWN OF SURFSIDE
	9293 Harding Ave
	Surfside, FL 33154-3000

Prepared By:	Debra Blanco
Date Prepared:	06/02/2020
Proposal #:	332393-2
Valid Until:	08/02/2020

Total Equipment Cost **\$0.00**
 Includes cable, connectors, hardware, switches, relays, terminal blocks, panels, etc., to ensure complete and operational system

Professional Integration Services **\$0.00**
 Includes engineering, project management, CAD, on-site installation and wiring, coordination and supervision, testing, checkout, owner training, etc. performed on the Owner's premises. Also includes all fabrication, modification, assembly, rack wiring, programming, warranties, etc., some performed at AVI-SPL

Direct Costs **\$0.00**
 Includes non equipment or labor costs, such as travel expenses, per diem, lift and vehicle rentals

General & Administrative **\$0.00**
 Includes all G & A expenses: bonds, vehicle mileage, shipping and insurance

Services - Device Maintenance **\$26,717.76**
 Includes post-installation maintenance options selected for installed devices

Subtotal	\$26,717.76
Tax	\$1,870.24
Total	\$28,588.00

* any and all applicable taxes will be included upon invoicing

Purchase orders should be addressed to Audio Visual Innovations, Inc.

See Addendum Attached Herein

Signed _____ Printed _____ Date _____

Audio Visual Innovations Inc. and Signal Perfection Ltd are wholly owned subsidiaries of AVI-SPL, Inc. This Entire Document and all information (including drawings, specifications and designs) presented by any subsidiary are the property of AVI-SPL Inc. Proprietary information provided to potential customers, clients or agents is for the sole purpose of demonstrating solutions delivery capabilities and shall be held in confidence. These Materials may not be copied, distributed or disclosed in any way without the sole written permission of an authorized representative of AVI-SPL. © Copyright AVI-SPL. All Rights Reserved



Services Summary



Audio Visual Innovations Inc. and Signal Perfection Ltd are wholly owned subsidiaries of AVI-SPL, Inc. This Entire Document and all information (including drawings, specifications and designs) presented by any subsidiary are the property of AVI-SPL Inc. Proprietary information provided to potential customers, clients or agents is for the sole purpose of demonstrating solutions delivery capabilities and shall be held in confidence. These Materials may not be copied, distributed or disclosed in any way without the sole written permission of an authorized representative of AVI-SPL. © Copyright AVI-SPL. All Rights Reserved



Room Summary - First Room

Equipment List

Mfg	Model	Description	Qty	Unit Price	Extended Price
Subtotal					\$0.00

Room Support and Maintenance

Elite Maintenance Services - Room; 12-months \$0.00

Device Maintenance

Mfg	Model	Description	Months	Qty	Unit Price	Extended Price
ENCO	ECAPTION4 SUPPORT	ANNUAL SUPPORT FOR ENCO CAPTION 4	12	3	\$5,995.00	\$17,985.00
AVISPL	AVIELITEERM	ANNUAL ONSITE SUPPORT FOR ENCO PRODUCTS	12	3	\$2,910.92	\$8,732.76
Subtotal						\$26,717.76



General Terms and Conditions

1. Applicability of Terms

1.1 These General Terms and Conditions (together with any addenda attached hereto and incorporated herein by this reference, the "Terms and Conditions") and the accompanying Audiovisual Solutions Proposal (the "Proposal") are the only terms and conditions which govern the sale of the equipment and any related software (the "Products") and services (the "Services") specified in the Proposal by Audio Visual Innovations, Inc. or Signal Perfection Ltd. (as applicable, "Seller") to the buyer/customer identified in the Proposal ("Buyer"). Seller and Buyer may be individually referred to as a "Party" and collectively as "Parties."

1.2 The Terms and Conditions and the Proposal (collectively, the "Agreement") comprise the entire agreement between the parties, and supersede all prior or contemporaneous understandings, agreements, negotiations, representations and warranties, and communications, both written and oral. In the event of a conflict or inconsistency between the General Terms and Conditions and any addendum, the addendum shall prevail to the extent of such conflict or inconsistency. In the event of a conflict between the Terms and Conditions and the Proposal, the Terms and Conditions shall prevail to the extent of such conflict or inconsistency. Notwithstanding anything herein to the contrary, if a master services agreement signed by both Parties is in effect covering the sale of the Products and Services that are the subject of the Proposal, the terms and conditions of said agreement shall prevail to the extent they conflict or are inconsistent with these Terms and Conditions.

2. Acceptance and Modification of Terms

2.1 This Agreement shall not be binding upon Seller until accepted by Buyer as set forth in this sub-Section 2.1 and the earlier of Seller's confirmation in writing of Buyer's order and Seller's performance under the applicable Proposal. Buyer's signed acceptance of the Agreement, issuance of order against the Agreement, payment for any of the Products or Services contained in the Agreement, or receipt of the Products or Services contained in the Agreement, whichever occurs first, shall constitute Buyer's acceptance of this Agreement.

2.2 Any modification, addition to, or waiver of any of this Agreement shall not be effective unless in writing and signed by an authorized representative of Seller, and any different or conflicting terms appearing in Buyer's purchase order or other documents are expressly rejected by Seller. No relaxation, forbearance or indulgence by a Party in enforcing any of the terms and conditions of this Agreement or the granting of any time to the other Party shall prejudice or restrict the rights and powers of a Party hereunder, nor shall waiver of any breach hereof operate as a waiver of any subsequent or continuing breach hereof.

3. Delivery

3.1 Seller will use its best efforts to deliver the Products in accordance with the Buyer requested delivery date, subject to receipt of all necessary information from Buyer and Buyer's compliance with Seller's reasonable instructions for site readiness. Shipping dates are approximate only, and Seller shall not be liable for failures of or delays in manufacture, delivery or installation resulting from any cause or causes beyond its reasonable control and without its fault or negligence.

3.2 Any delay due to causes beyond Seller's reasonable control and without Seller's fault or negligence shall extend delivery dates to the extent caused thereby. Seller will use reasonable efforts to timely notify Buyer in the event of a delay. Buyer shall reimburse the Seller its reasonable additional expenses resulting from any Buyer-caused delay. When delivery of the Products is delayed at the request of the Buyer and the Products have already been shipped by Seller's vendor, Seller will place the Products in storage and invoice Buyer the price of such Products, which will be promptly paid. Seller shall not be liable, and the Buyer shall have no right to cancel or rescind this Agreement, in the event of any delay due to causes beyond Seller's reasonable control and without Seller's fault or negligence, and Buyer shall accept such delayed performance by Seller. The Buyer's receipt of the Products shall constitute a waiver of any claims for delay.

4. Billing and Payment Terms

Unless otherwise agreed in writing by Buyer and Seller in the Proposal, the total Proposal price, excluding the price for Stand-alone Services (as defined in this section), shall be billed as follows: 50% down payment at time of order, 40% upon delivery at Seller; 10% upon project completion and Buyer sign-off or first beneficial use, whichever occurs first, payable net 30 from Buyer's receipt of invoice. For purposes of this Agreement, "Stand-alone Services" means any Services not attached to an installation project. Unless otherwise specified in the Proposal, Products are sold F.O.B. origin-Buyer to pay all shipping charges. If this Proposal covers Products or Services for more than one system, room, suite, or location, for purposes of payment in accordance with payment terms stated on the face hereof each room, suite, or location shall be treated as if the subject of a separate sale and payment made accordingly. Unless otherwise specified in the Proposal, all pricing and amounts are in US Dollars and all billing and payment shall be made in US Dollars.

5. Buyer in Arrears or Default

In the event Buyer is in arrears with any payment whatsoever due from it to Seller at any time, whether in respect of the Proposal price or any other amount due from the Buyer to the Seller under the terms of this Agreement, the amount in arrears shall bear interest at the rate of 1.5% per month or the maximum rate permitted by applicable law, whichever is less, as from the date each amount falls due, pending actual payment thereof in full, without prejudice to any relief or remedy available to Seller. In the event of Buyer's default, Seller may, without notice, peaceably enter any premises in which the Products are located and remove, hold and sell them in accordance with applicable law, to satisfy in whole or in part Buyer's obligations.

6. Title and Risk of Loss

6.1 Title to the Products shall pass to Buyer upon delivery, subject to the manufacturer's or Seller's software license (if applicable) and a purchase money security interest retained by Seller in the Products sold and the proceeds thereof until payment of all amounts then due to Seller. Seller shall be entitled to remove the Products from the Buyer's premises if all payments are not made when due. Buyer agrees to reasonably cooperate with Seller in the execution and filing of financing statements under the Uniform Commercial Code or other documents as Seller reasonably requests to protect its security interest.

Audio Visual Innovations Inc. and Signal Perfection Ltd are wholly owned subsidiaries of AVI-SPL, Inc. This Entire Document and all information (including drawings, specifications and designs) presented by any subsidiary are the property of AVI-SPL Inc. Proprietary information provided to potential customers, clients or agents is for the sole purpose of demonstrating solutions delivery capabilities and shall be held in confidence. These Materials may not be copied, distributed or disclosed in any way without the sole written permission of an authorized representative of AVI-SPL. © Copyright AVISPL. All Rights Reserved



6.2 Risk of loss or damage to the Products or any part thereof shall pass to the Buyer upon delivery.

7. Installation and Site Preparation

7.1 Installation (e.g. field assembly, interconnection, equipment calibration and checkout) is to be performed by the Seller's trained technical employees. The Seller shall be entitled to employ subcontractors and/or agents to assist in or carry out, in whole or in part, the installation. ~~In the event installation by Seller employees is prevented by trade unions, the Buyer shall arrange with the trade unions at its own expense to complete installation. The Seller is thereafter liable only for engineering supervision of installation.~~

7.2 The Seller shall reasonably coordinate and cooperate with other trades to facilitate satisfactory work progress. If the Seller's work in progress is impeded by other trades and/or contractors (excluding the Seller's own subcontractors) or by scheduling delays due to the Buyer, time delays in the final installation as well as additional charges, including labor, travel and other reasonable expenses, may result.

7.3 The Buyer shall be responsible for preparing, at its own expense, the installation site in accordance with the Seller's reasonable instructions, including the requirements specified in the Proposal. In no event shall the Seller be responsible for any high voltage electrical work, ceiling modifications, structural modifications, or mechanical systems modifications. Unless otherwise agreed in writing in the Proposal, Buyer shall provide the Seller with source code for any non-Seller programmed remote control system required to be modified under the terms of this Agreement.

8. Access to Project Site

8.1 The Buyer shall provide the Seller with reasonable access to the installation site before delivery, for purposes of determining site readiness for installation, and shall designate an individual on Buyer's staff to serve as a contact person for all site preparation and installation issues. Buyer shall provide the Seller with free access to the installation site for the purpose of preparation for installation.

8.2 Buyer shall obtain at its expense and keep effective all permissions, licenses, and permits whenever required in connection with the installation and/or use of the Products and the premises where the Products shall be situated.

9. Warranty

9.1 Seller warrants that:

- (a) Immediately prior to delivery, it had good title to the Products, free from any lien or encumbrance unless otherwise specified;
- (b) For a period of ninety (90) days from delivery and acceptance of the Products and Services, or, with respect to Products manufactured by a third party, such longer period of time provided by such manufacturer, the Products and Services will (i) be free from defects in materials or workmanship and (ii) conform to the requirements of the Proposal, including any instructions, specifications and documentation incorporated therein;
- (c) It is in compliance with all applicable federal, state and local laws, regulations and standards relating to the sale and transportation of the supplies or items, and provision of the Products including all applicable U.S. and foreign anti-corruption laws, including without limitation, the U.S. Foreign Corrupt Practices Act ("FCPA"); and
- (d) With respect to Services, Seller's personnel shall possess the requisite level of training, skill and experience to address the requisite tasks efficiently and will

perform the Services provided hereunder in a professional and workmanlike manner consistent with generally accepted industry standards.

9.2 Seller shall not be liable for nor have any warranty obligations with respect to Products that are in any way misused, altered and/or repaired by someone other than a representative of the Seller which, within the sole, reasonable judgment of the Seller, results in an adverse effect, including effects upon performance or reliability of the Products.

9.3 In order to make a warranty claim, Buyer shall promptly notify Seller in writing and Seller will, subject to the applicable manufacturer's warranty policy, repair or replace such defective Product at no cost to Buyer. Seller will attempt to reply to warranty claims received from Buyer prior to 1:00 p.m. within forty-eight hours. Normal working hours are 8 a.m. to 5 p.m., Monday through Friday, excluding legal holidays. Buyer shall reasonably and promptly cooperate with Seller's request for information regarding the claim and with return of the defective Product if required.

9.4 Except as otherwise specified in this Agreement, no warranty whatsoever is provided by the Seller hereunder as to Products manufactured by anyone other than the Seller, including but not limited to, cables, lamps, batteries, glassware, and evacuated devices (including valve, cathode ray tubes, and other special electron tubes). Seller's sole obligation with respect to Products manufactured by someone other than Seller shall be to pass through the applicable warranties, if any, provided by the manufacturer. THE WARRANTIES SET FORTH IN THIS AGREEMENT ARE EXCLUSIVE AND IN LIEU OF ALL OTHER WARRANTIES, WHETHER WRITTEN OR ORAL, IMPLIED OR STATUTORY. NO IMPLIED WARRANTY OF MERCHANTABILITY OR FITNESS FOR A PARTICULAR PURPOSE SHALL APPLY.

10. Buyer Responsibilities

Buyer or any user of the Products shall (i) notify Seller as soon as any unusual operating peculiarity appears, and (ii) operate the Products in a safe and competent manner in strict compliance with the Product specifications and operating procedures and applicable laws and government regulations. In the event the Buyer or any user of the Products fails to comply with this Section 10, Seller's warranties and its obligations hereunder shall terminate without notice to Buyer.

11. Limitation of Liability and Exclusion of Damages

TO THE FULLEST EXTENT ALLOWED BY APPLICABLE LAW, IN NO EVENT WILL EITHER PARTY BE LIABLE FOR INCIDENTAL, CONSEQUENTIAL, SPECIAL, EXEMPLARY, OR INDIRECT DAMAGES, LOST BUSINESS PROFITS, OR LOSS, DAMAGE OR DESTRUCTION OF DATA, ARISING OUT OF OR IN ANY WAY RELATED TO THIS AGREEMENT AND THE RELATIONSHIP AND/OR DEALINGS BETWEEN BUYER AND SELLER, REGARDLESS OF THE FORM OF ACTION, WHETHER IN CONTRACT, TORT (INCLUDING NEGLIGENCE), BREACH OF WARRANTY OR OTHERWISE, EVEN IF SUCH PARTY HAS BEEN ADVISED AS TO THE POSSIBILITY OF SAME. EXCEPT FOR SELLER'S GROSS NEGLIGENCE, WILLFUL MISCONDUCT OR FRAUD, SELLER'S AGGREGATE LIABILITY ARISING OUT OF OR RELATED TO THIS AGREEMENT SHALL NOT EXCEED THE TOTAL AMOUNT PAID OR PAYABLE BY BUYER UNDER THIS AGREEMENT. THE ABOVE LIMITATION WILL APPLY WHETHER AN ACTION IS IN CONTRACT OR TORT AND REGARDLESS OF THE THEORY OF LIABILITY.

12. Taxes

12.1 Any and all taxes levied or based on the prices in this Agreement, or the Products being sold hereunder, exclusive of any taxes based on net income, shall be added to the purchase prices set forth in the Proposal, except to the extent the Buyer provides the Seller with a valid tax exemption certificate approved by Seller.

Audio Visual Innovations Inc. and Signal Perfection Ltd are wholly owned subsidiaries of AVI-SPL, Inc. This Entire Document and all information (including drawings, specifications and designs) presented by any subsidiary are the property of AVI-SPL Inc. Proprietary information provided to potential customers, clients or agents is for the sole purpose of demonstrating solutions delivery capabilities and shall be held in confidence. These Materials may not be copied, distributed or disclosed in any way without the sole written permission of an authorized representative of AVI-SPL. © Copyright AVISPL. All Rights Reserved



12.2 All payments to be made hereunder shall be made in cleared funds, without any deduction or set-off and free and clear of and without deduction for or on account of any taxes, levies, imports, duties, charges, fees and withholdings of any nature now or hereafter imposed by any governmental, fiscal or other authority save as required by law. If Buyer is compelled to make any such deduction, it will pay to Seller such additional amounts as are necessary to ensure receipt by Seller of the full amount which Seller would have received but for the deduction.

13. Confidentiality Subject to Florida Public Records Law (Ch. 119, F.S.)

13.1 Each Party may from time to time during the Agreement, in the course of discussions or dealings with each other, receive or learn, orally, visually or through any tangible medium, certain information regarding the other Party's business, including but not limited to, its products, inventions, operations, methodologies, systems, processes, product development plans or intentions, know-how, designs, trade secrets, market opportunities, business or financial affairs, and technical, marketing, financial, employees, planning, intellectual property and other confidential or proprietary information ("Confidential Information"). Confidential Information does not include, and the restrictions in this Agreement shall not apply with respect to, information (i) possessed by or independently developed by the receiving Party prior to any disclosure, (ii) obtained from sources other than the disclosing Party, which sources had no obligation of confidentiality to disclosing Party with respect to the Confidential Information, or (iii) which is within the public domain when disclosed or becomes part of the public domain after disclosed to the receiving Party without fault on the part of the receiving Party. Seller's Confidential Information also includes the terms of this Agreement.

13.2 The Confidential Information of a Party belongs to that Party. The receiving Party will not disclose the Confidential Information of the disclosing Party to any third party without the disclosing Party's prior written consent. The receiving Party will not use the Confidential Information of the disclosing Party for any purpose not expressly permitted by this Agreement or to carry out the Services or the sale of Products, and will disclose the Confidential Information of the disclosing Party only to the employees or contractors of the receiving Party who have a need to know such Confidential Information for purposes of carrying out the Services or the sale of Products and who are under a duty of confidentiality no less restrictive than the receiving Party's duty hereunder. Receiving Party will protect the disclosing Party's Confidential Information from unauthorized use, access, or disclosure in the same manner as the receiving Party protects its own confidential or proprietary information of a similar nature and with no less than reasonable care.

13.3 Receiving Party will, upon completion or termination of this Agreement or promptly upon request from the disclosing Party, return or destroy all Confidential information of the disclosing Party, including any documents or materials that contain any Confidential Information of the disclosing Party. Notwithstanding anything to the contrary in this Agreement, the receiving Party (i) may retain one (1) copy of the disclosing Party's Confidential Information solely for archival, audit, disaster recovery, legal or regulatory purposes and (ii) will not be required to search archived electronic back-up files of its computer systems for the disclosing Party's Confidential Information in order to purge the disclosing Party's Confidential Information from its archived files; provided, however, that the receiving Party must (i) maintain its confidentiality under this Agreement as if it were still in effect, and (ii) not use the retained Confidential Information of the disclosing Party for any other purpose.

13.4 The Parties recognize that a violation of this Section 13 can cause irreparable harm to the business of the disclosing Party that could not be adequately compensated by the payment of money damages and agree that the disclosing Party may seek injunctive relief against any actual or threatened breach of this Section 13

in addition to any other available legal and equitable remedies. The prevailing Party in any action to enforce this Section 13 shall be entitled to recover from the non-prevailing Party reasonable attorneys' fees in addition to other relief granted in such action.

14. Force Majeure

Except for payment for amounts due under the Agreement, neither Party will be liable to the other for delays or failures to perform occasioned by causes beyond its reasonable control and without its fault or negligence. Such acts or events shall include but not be limited to, acts of God, civil or military authority, civil disturbance, riot, fire, strikes, lockouts or slowdowns, factory or labor conditions, inability to obtain necessary labor, materials or manufacturing facilities, and delayed issuance of export control licenses. In the event of such delays or failures to perform, any dates or times by which either Party is otherwise scheduled to perform shall be extended automatically for a period of time equal in duration to the additional time required because of the delay or failure to perform. The Party claiming force majeure shall promptly inform the other Party of any event of force majeure, and its expected duration and cessation. The Party claiming force majeure shall use its best efforts to mitigate such effects to the extent reasonably practicable.

15. Restocking Fees

In the event Buyer wishes to return any Products based on reasons outside of Seller's control, including but not limited to Buyer's cancellation or termination of this Agreement or any portion thereof for its convenience, Buyer agrees, in addition to any other amounts due under this Agreement, to reimburse Seller for any and all third party cancellation/restocking fees incurred by Seller.

16. Termination

16.1 Seller may, without prejudice to any rights or remedies available to Seller under this Agreement, at law or in equity, terminate this Agreement immediately for cause in the event Buyer breaches a material term of this Agreement (it being understood that Buyer's payment obligations shall constitute a material term) and such breach is not cured within thirty (30) days after written notice thereof. Seller may also, without prejudice to any rights or remedies available to Seller under this Agreement, at law or in equity, terminate this Agreement immediately for cause upon written notice if Buyer: (i) breaches a material term of this Agreement and such breach is incapable of cure, (ii) fails on multiple occasions to pay any amounts when due, (iii) is declared insolvent or adjudged bankrupt by any court of competent jurisdiction, or (iv) makes an assignment for the benefit of creditors, or a petition in bankruptcy or reorganization or an arrangement with creditors is filed by or against Buyer and not dismissed within thirty (30) days. Upon Seller's termination of this Agreement for cause, without waiving or otherwise limiting any other remedies available to Seller under this Agreement, at law or in equity, Buyer shall become immediately liable for any outstanding charges for Products delivered and/or Services performed up to the date of termination, any third party restocking/cancellation fees incurred by Seller, and any interest on any and all past due charges as set forth in this Agreement.

16.2 Buyer may, without prejudice to any rights or remedies available to Buyer under this Agreement, at law or in equity, terminate this Agreement immediately for cause in the event Seller breaches a material term of this Agreement and such breach is not cured within thirty (30) days after written notice thereof. Buyer may also, without prejudice to any rights or remedies available to Buyer under this Agreement, at law or in equity, terminate this Agreement immediately for cause upon written notice if Seller: (i) breaches a material term of this Agreement and such breach is incapable of cure, (ii) is declared insolvent or adjudged bankrupt by any court of competent jurisdiction, or (iii) makes an assignment for the benefit of

Audio Visual Innovations Inc. and Signal Perfection Ltd are wholly owned subsidiaries of AVI-SPL, Inc. This Entire Document and all information (including drawings, specifications and designs) presented by any subsidiary are the property of AVI-SPL Inc. Proprietary information provided to potential customers, clients or agents is for the sole purpose of demonstrating solutions delivery capabilities and shall be held in confidence. These Materials may not be copied, distributed or disclosed in any way without the sole written permission of an authorized representative of AVI-SPL. © Copyright AVISPL. All Rights Reserved



creditors, or a petition in bankruptcy or reorganization or an arrangement with creditors is filed by or against Buyer and not dismissed within thirty (30) days.

16.3 Buyer may, upon written notice to Seller, terminate this Agreement for its convenience provided, however, that Seller shall be paid for all Products delivered and Services performed up to the effective date of termination (less amounts already paid) plus reimbursed for any third party restocking/cancellation fees in accordance with Section 15.

16.4 Upon any expiration or termination of this Agreement, in addition to any other provisions of this Agreement that state survival after termination or expiration of this Agreement, and notwithstanding expiration, completion or termination of this Agreement, the Parties shall continue to be bound by the provisions of this Agreement that, by their nature, shall survive such completion or termination, including without limitation provisions relating to warranties, governing law and jurisdiction, and confidentiality.

17. Governing Law and Jurisdiction

17.1 This Agreement shall be interpreted in accordance with and governed in all respects by the laws of the State of Florida without giving effect to its conflicts of law rules. Any dispute related to, arising out of, or in connection with this Agreement shall be subject to the exclusive jurisdiction of the courts in ~~Hillsborough County, Florida and the United States District Court for the Middle District of Florida.~~ ^{Miami-Dade County}. In the event of legal proceedings arising out of or relating to this Agreement, the prevailing Party, as determined by the court, shall be entitled to recover, from the non-prevailing Party, reasonable costs suffered or incurred in connection with such proceedings including, but not limited to, court fees, attorneys' fees, expenses and costs of investigation and court.

17.2 TO THE FULLEST EXTENT PERMITTED BY APPLICABLE LAWS, SELLER AND BUYER EACH WAIVE ANY RIGHTS WHICH EITHER MAY HAVE TO TRIAL BEFORE A JURY OF

ANY DISPUTE ARISING FROM, OR RELATED TO, THIS AGREEMENT. SELLER AND BUYER FURTHER STIPULATE AND CONSENT THAT ANY SUCH LITIGATION BEFORE A COURT OF COMPETENT JURISDICTION SHALL BE NON-JURY.

18. Miscellaneous

18.1 The Proposal shall be firm for the period shown on the face of the Proposal, subject to withdrawal or change by the Seller upon notice at any time prior to Buyer's acceptance. Notwithstanding the foregoing, the Seller shall have the right to amend the price of the Products to reflect current conditions that affect the price, including increase in raw material prices, and tariffs that had not been imposed at the time this Agreement was submitted to Buyer.

18.2 In providing the Products, Seller shall be deemed to be an independent contractor and its personnel and representatives shall not act as nor be Buyer's agents or employees. Seller shall have complete charge and responsibility for personnel employed or engaged by Seller.

18.3 Buyer may not assign any of its rights or obligations under this Agreement, including by purchase, merger or operation of law, without the prior written consent of Seller, which consent shall not be unreasonably withheld or delayed. Seller may assign this Agreement to any of its affiliates or any successor of all or substantially all of its business. Any attempted assignment or transfer in violation of this sub-Section 18.4 shall be null and void.

18.4 If any provision of this Agreement shall be held to be invalid, illegal, or unenforceable, the remaining terms of this Agreement shall in no way be affected or impaired.

Buyer Acceptance

See Addendum Attached Hereto

Signed Name

Printed Name, Title

Company Name

Date

Audio Visual Innovations Inc. and Signal Perfection Ltd are wholly owned subsidiaries of AVI-SPL, Inc. This Entire Document and all information (including drawings, specifications and designs) presented by any subsidiary are the property of AVI-SPL Inc. Proprietary information provided to potential customers, clients or agents is for the sole purpose of demonstrating solutions delivery capabilities and shall be held in confidence. These Materials may not be copied, distributed or disclosed in any way without the sole written permission of an authorized representative of AVI-SPL. © Copyright AVISPL. All Rights Reserved



Addendum to General Terms and Conditions – Software License

The following terms supplement and modify the General Terms and Conditions as they apply to Seller's provision of control system integration and programming as more particularly described in this Addendum and the Proposal. Any capitalized terms not otherwise defined herein shall have the meanings ascribed to them in the General Terms and Conditions.

1. License Grant and Ownership

1.1 Seller hereby grants to Buyer a worldwide, perpetual, non - exclusive, non - transferable license to all Software for its use in connection with the establishment, use, maintenance and modification of the control system implemented by Seller. The term "Software" for the purposes of this Software License shall refer to all source code, executable object code, and the patches, scripts, modifications, enhancements, designs, concepts or other materials that constitute the software programs necessary for the proper function and operation of the control system as delivered by Seller and accepted by Buyer.

1.2 Except as expressly set forth in this paragraph, Seller shall at all times own all intellectual property rights to the Software. Any and all licenses, product warranties or service contracts provided by third parties in connection with the Software or control system in which such Software is implemented shall be delivered to Buyer for the sole benefit of Buyer.

1.3 Buyer may supply to Seller or allow Seller to use certain proprietary information, including service marks, logos, graphics, software, documents and business information and plans that have been authored or pre-owned by Buyer. All such intellectual property shall remain the exclusive property of Buyer and shall not be used by Seller for any purposes other than those associated with delivery of the control system.

2. Copies, Modification and Use

2.1 Buyer may make copies of the Software solely for archival purposes and as required for modifications to the control system in which such Software is implemented. All copies and distribution of the Software shall remain within the direct control of Buyer and its representatives.

2.2 Buyer may make modifications to the source code version of the Software, if and only if the results of all such modifications are applied solely to the control system in which the Software is implemented. In no way does this Software License confer any right in Buyer to license, sublicense, sell, or otherwise authorize the use or distribution of the Software, whether in executable form, source code or otherwise, by any third parties, except in connection with the use of the control system for Buyer's internal business needs.

2.3 All express or implied warranties relating to the Software shall be deemed null and void in case of any modification to the Software made by any party other than Seller or Seller's authorized personnel.

3. Warranties and Representations

3.1 the Software and all intellectual property therein, are original to Seller or its third party licensors; and

3.2 the Software, as delivered by Seller as part of the control system, will not infringe or otherwise violate the intellectual property rights of any third party.

4. Indemnification

4.1 Seller hereby indemnifies and shall defend and hold harmless Buyer, its parent companies and its and their subsidiaries, affiliates, officers, directors, employees, agents and subcontractors from and against all liability, damages, loss, cost or expense, including but not limited to reasonable attorneys' fees and expenses, arising out of or in connection with any third party claims that the Software as delivered by Seller or any intellectual property therein infringes or otherwise violates any rights of any such third party. In no event will Seller have any obligations under this provision in the event such infringement results from (i) use of the Software or control system in which it is implemented in violation of this Software License, (ii) modification or alteration of the Software or the control system in which it is implemented by someone other than Seller or Seller's authorized personnel, (iii) content or specifications provided by Buyer, or (iv) use of the Software or control system in which it is implemented in combination with any other software, hardware, services or other materials other than as provided by Seller or authorized in the applicable manufacturer specifications.

4.2 Buyer hereby indemnifies and shall defend and hold harmless Seller, its parent companies and its and their subsidiaries, affiliates, officers, directors, employees, agents and third party licensors from and against all liability, damages, loss, cost or expense, including but not limited to reasonable attorneys' fees and expenses, arising out of or in connection with any third party claims that Buyer's use of the Software in contravention of the grant of rights in this Software License infringes or otherwise violates any rights of any such third party.

4.3 Upon the assertion of any claim or the commencement of any suit or proceeding against an indemnitee by any third party that may give rise to liability of an indemnitor hereunder, the indemnitee shall promptly notify the indemnitor of the existence of such a claim and shall give the indemnitor reasonable opportunity to defend and to settle the claim at its own expense and with counsel of its own selection. The indemnitee shall cooperate with the indemnitor, shall at all times have the full right to participate in such a defense at its own expense and shall not be obligated, against its consent, to participate in any settlement which it reasonably believes would have an adverse effect on its business.

5. Term and Termination

This Software License will automatically terminate upon the disassembly of the control system in which the Software is implemented, unless the control system is reassembled in its original configuration in another location. Seller may terminate this Software License upon notice for Buyer's failure to comply with any of the terms set forth in this Software License. Upon termination, Buyer is obligated to immediately destroy the Software, including all copies and modifications.

Audio Visual Innovations Inc. and Signal Perfection Ltd are wholly owned subsidiaries of AVI-SPL, Inc. This Entire Document and all information (including drawings, specifications and designs) presented by any subsidiary are the property of AVI-SPL Inc. Proprietary information provided to potential customers, clients or agents is for the sole purpose of demonstrating solutions delivery capabilities and shall be held in confidence. These Materials may not be copied, distributed or disclosed in any way without the sole written permission of an authorized representative of AVI-SPL. © Copyright AVI-SPL. All Rights Reserved



Addendum to General Terms and Conditions - Support and Maintenance Services

The following terms supplement and modify the General Terms and Conditions as they apply to Seller's provision of support and maintenance services as more particularly described in this Addendum and the Support and Maintenance Services Description (collectively, the "Services"). Any capitalized terms not otherwise defined herein shall have the meanings ascribed to them in the General Terms and Conditions.

1. Definitions

This Addendum contains defined terms and acronyms. The following definitions shall apply:

"Help Desk" means Seller's 24x7 global help desk as described in the Support and Maintenance Services Description and this Addendum;

"In-Warranty Hardware" means the covered equipment has an active, Manufacturer or third-party sponsored warranty program that can be exercised by the Buyer or by the Seller on behalf of the Buyer;

"Manufacturer" means an entity that produces hardware and / or software;

"Out-of-Warranty Hardware" means the covered equipment does not have an active, Manufacturer or third-party sponsored warranty program that can be exercised by the Buyer or by the Seller on behalf of the Buyer;

"Software Options" means optional functionality or features of software that may be selected at the time of purchase or later, and for which separate charges are assessed;

"Software Update" means software for which the Manufacturer has provided fixes or minor revisions to correct errors or defects in the existing operation of the software in accordance with the published product specifications, and which is limited to those updates that the Manufacturer generally provides to its customers at no charge. Software Updates do not include Software Upgrades or Software Options;

"Software Upgrade" means new releases of the software which contains enhancements improving the functionality or capabilities of the software, which Manufacturer may make available to its customers. Software Upgrades do not include Software Options; and

"Support and Maintenance Services Description" means that portion of the Proposal detailing the Services being purchased by Buyer.

2. Services Description

The Services purchased by Buyer are detailed in the Support and Maintenance Services Description.

3. Services Orders

Following Seller's order confirmation, Buyer agrees to provide a contact name, contact email address, and telephone number at the service location(s). Standard response times and service level agreements are not guaranteed until such information is received by the Help Desk.

Products specifically identified in the proposal will be eligible for Services. If Buyer elects to purchase any additional or optional services or features, additional fee(s) will be invoiced separately with payment terms as specified for such services.

4. Services Term

The Services shall commence upon installation project completion or, for Stand-alone

Services, upon Seller's confirmation of Buyer's order, and shall continue for the term specified in the Proposal, unless earlier terminated. Installation projects containing multiple phases or being performed over extended periods may include multiple completion milestones / service commencement dates. The Services shall expire at the conclusion of the term specified in the Proposal, unless earlier terminated. Notwithstanding anything to the contrary in the Terms and Conditions, Seller reserves the right to postpone commencement of the Services, upon written notice to Buyer, in the event of any delays that prevent Seller from commencing the Services on the original commencement date. In such case, Seller will provide a new Services commencement date and the term of the Services will commence as of that date and continue for the term specified in the Proposal, notwithstanding any specific dates contained in the Agreement or any other purchase documents. Invoicing and payment will be adjusted to align with the new commencement date of the Services.

5. Services Availability

Help Desk remote support is available on a 24x7 basis.

Unless otherwise noted in the Support and Maintenance Services Description, the Seller's field service technicians are available Monday through Friday from 8 AM to 5 PM local standard time, excluding legal holidays. For Buyers with service locations in the United Arab Emirates, the Seller's field service technicians are available Sunday through Thursday from 8 AM to 5 PM local standard time, excluding legal holidays.

Requirements to provide Services prior to or after the agreed upon hours of support must be agreed to by both Parties in advance and in writing and additional fees may apply.

6. Third Party Services

Seller may make third party services available to Buyer. Seller offers no guarantees and assumes no responsibility or liability of any kind with respect to third party services.

7. Software Updates, Upgrades, and Options

The Help Desk will assist with the provision of Software Updates, Upgrades, or Options when necessary to resolve a reported issue and when made available by the Buyer or Manufacturer. Depending on Services elected, additional charges may apply for proactive management of Software Updates, Upgrades, or Options and when specialist or onsite support of these activities is requested or required. Seller will not be liable for any issues, damages or disruption arising from a Software Update, Upgrade, or Option released by a third party.

8. Replacement Parts

Standard program: In-Warranty Hardware will be eligible for repairs or replacement parts and the use of advanced replacement programs in accordance with the Manufacturer's published warranty program.

Replaced parts will become the property of Seller or the Manufacturer. If replacement activity is performed by Buyer, the replaced parts must be returned per the Seller's

Audio Visual Innovations Inc. and Signal Perfection Ltd are wholly owned subsidiaries of AVI-SPL, Inc. This Entire Document and all information (including drawings, specifications and designs) presented by any subsidiary are the property of AVI-SPL Inc. Proprietary information provided to potential customers, clients or agents is for the sole purpose of demonstrating solutions delivery capabilities and shall be held in confidence. These Materials may not be copied, distributed or disclosed in any way without the sole written permission of an authorized representative of AVI-SPL. © Copyright AVISPL. All Rights Reserved



direction within five (5) business days of receipt of the replacement part; otherwise, Buyer will be invoiced the full list price for the replaced part.

Depending on Services elected, additional charges may apply for onsite support of In-Warranty Hardware parts repair or replacement. Out-of-Warranty Hardware or other parts repair or replacement deemed to be out-of-warranty will be considered billable activity.

Optional program: Buyers who elect an extended hardware warranty as a component of their Services are eligible for repairs or replacement parts for Out-of-Warranty Hardware. The inclusion of this coverage must be incorporated into the Support and Maintenance Services Description and is further described therein.

9. Service Level Agreement

Help Desk response: Seller's Help Desk will provide an average speed of answer of sixty (60) seconds for support calls and will respond to new service requests made via email or web portal to its Help Desk within four (4) hours with case assignment notification.

Upon the Help Desk's determination that a dispatch is required, Seller's field service technicians will provide the onsite response aligned to the service level elected in the Support and Maintenance Services Description. The ability to meet this service level may be impacted by the Buyer's room availability, the requirement for replacement parts, and the reliance on a Buyer's third-party.

When a case is opened, the Help Desk will classify the case in accordance with the following incident priority classifications:

Priority 1 – core business or technology functionality unavailable resulting in work stoppage or significant impact to user experience

Priority 2 – a loss in functionality that compromises but does not prevent work completion or have significant impact to user experience

Priority 3 – issue that does not compromise work completion and therefore does not require immediate attention

Priority 4 – issue that can be scheduled such as a maintenance activity or scheduled replacement

10. Services Exclusions

Unless otherwise specified in the Support and Maintenance Services Description, Services do not cover any of the following: (i) electrical work and / or in-house cabling; (ii) repair or replacement resulting from natural disaster, fire, accident, neglect, misuse, vandalism, water, corrosion, power surges, unconditioned or fluctuating power, Buyer-provided network, or failure of the installation site to conform to Manufacturer specifications; or resulting from use other than intended purposes; or resulting from use with items not provided or approved by Seller; or resulting from the performance of maintenance or the attempted repair by persons other than Seller's employees or persons authorized by Seller; (iii) repair or replacement excluded by or no longer covered by the Manufacturer's repair and replacement program; (iv) furnishing supplies or accessories including consumables such as projection lamps, bulbs, filters, fuses, batteries and the labor to replace these items; (v) relocation services, or the addition or removal of items from or to other devices not furnished by Seller; (vi) damage to displays caused by screen burnout or image "burn-in"; and (vii) Services in connection with computer viruses or conflicts involving software that is not installed or introduced by Seller including coverage for Buyer-furnished product unless specifically listed as covered product.

Audio Visual Innovations Inc. and Signal Perfection Ltd are wholly owned subsidiaries of AVI-SPL, Inc. This Entire Document and all information (including drawings, specifications and designs) presented by any subsidiary are the property of AVI-SPL Inc. Proprietary information provided to potential customers, clients or agents is for the sole purpose of demonstrating solutions delivery capabilities and shall be held in confidence. These Materials may not be copied, distributed or disclosed in any way without the sole written permission of an authorized representative of AVI-SPL. © Copyright AVISPL. All Rights Reserved

Any modifications and / or additions made without Seller's prior written approval are at Buyer's sole risk and expense. If, in Seller's reasonable discretion, such modifications and / or additions cause defects, disruptions and / or malfunction, and Buyer requests Seller's assistance to correct the issue, Seller's assistance will be billable at Seller's then-current time and material rates.

11. Charges and Payment Terms

Unless otherwise specified in the Proposal, payment terms are net 30 days from Buyer's receipt of invoice. Unless otherwise specified in the Proposal, Stand-alone Services will be billed upon Seller's confirmation of Buyer's order. Any services provided that are not included in the Services will be billable as incurred.

12. Termination

Seller may immediately terminate the Services upon written notice in whole or in part for cause if any person other than a Seller employee or designated service representative alters covered equipment rendering it unsafe.

In the event of Buyer's early termination for cause, a pro-rated refund will be issued to the Buyer for the unused term of Services, except Buyer shall remain liable for (i) all non-refundable third-party fees incurred by Seller for prepaid expenses and (ii) all services performed during Services term. Services may not be terminated for convenience.

Seller reserves the right to terminate or modify available Services at any time in its sole discretion; provided, however, that any such termination or modifications will not affect any Services already ordered by Buyer and confirmed by Seller prior to such termination or modifications except as mutually agreed by both Parties.

13. Buyer Obligations

(a) Buyer shall provide Seller with all information, cooperation and access that Seller reasonably requests for remote diagnosis of the reported issue. Parts replacement and onsite service may not become available until the Help Desk is provided the appropriate information or support to diagnose the issue.

(b) If applicable, Buyer shall provide Seller personnel with timely access to service location and adequate working space at no charge to Seller.

(c) Buyer shall provide Seller's onsite managed services personnel with adequate working conditions that comply with all applicable labor, safety and health laws and regulations.

(d) Buyer will provide the necessary utility services for use in accordance with the Manufacturer's applicable published specifications.

(e) Buyer will be responsible for payment of parts and services provided by Seller that are not covered by the Services. Seller will obtain Buyer's written consent prior to providing the parts and / or services, which will be billable at Seller's then-current time and material rates.

(f) Seller strongly recommends that Buyer install and use a current, reputable anti-virus program in connection with any PC-based, open-architecture product, and that Buyer regularly updates and runs such anti-virus program, especially in connection with the emergence of any new viruses.

(g) Buyer is solely responsible for backing up its data. Seller will not under any circumstances have a duty to back up Buyer's data or to restore data that is lost in the course of Seller's provision of Services, or otherwise. Seller will not be liable for the



~~loss of Buyer's data, whatever the reason for the loss, including without limitation as a result of Seller's negligence. The preceding limitation applies to any cause of action, whether based in contract, tort, or any other theory.~~

14. Solicitation

At no time during the term of the Services or for one (1) year thereafter, will Buyer directly or indirectly offer employment to any Seller employees who performs Services on behalf of Seller without Seller's express prior written consent. ~~In the event that Buyer is in breach of this provision, Seller shall have the right to Invoice Buyer, and Buyer agrees to pay a sum equal to twelve (12) months' salary in respect of the hired individual.~~ The foregoing restrictions shall not apply to solicitation through any general recruitment advertisement in the normal course of business, without specifically targeting or approaching the other Seller's employees.

15. Warranty and Limitation of Liability

SELLER WARRANTS FOR NINETY (90) DAYS FROM THE PERFORMANCE OF ANY SERVICES HEREUNDER THAT SUCH SERVICES SHALL BE PERFORMED IN A WORKMANLIKE MANNER CONSISTENT WITH GENERALLY ACCEPTED INDUSTRY STANDARDS. SELLER MAKES NO OTHER WARRANTY, EITHER EXPRESS OR IMPLIED, INCLUDING, BUT NOT LIMITED TO, ANY WARRANTY OF FITNESS FOR A PARTICULAR PURPOSE OR OF MERCHANTABILITY. SELLER MAKES NO WARRANTY THAT OPERATION OF THE PRODUCT SERVICED WILL BE UNINTERRUPTED OR ERROR FREE. BUYER MUST PROMPTLY REPORT IN WRITING ANY BREACH OF THIS WARRANTY TO SELLER NO LATER THAN FIFTEEN (15) DAYS AFTER EXPIRATION OF THE ABOVE WARRANTY PERIOD, AND BUYER'S EXCLUSIVE REMEDY AND SELLER'S ENTIRE LIABILITY FOR ANY BREACH OF SUCH WARRANTY SHALL BE FOR SELLER TO RE-PERFORM THE SERVICES OR, IF SELLER IS UNABLE TO RE-PERFORM THE SERVICES AS WARRANTED, BUYER SHALL BE ENTITLED TO RECOVER THE PRORATED FEES PAID TO SELLER FOR THE NONCONFORMING SERVICES. ~~SUBJECT TO THE EXCLUSION OF DAMAGES PROVISION CONTAINED IN THE GENERAL TERMS AND CONDITIONS, SELLER'S MAXIMUM LIABILITY FOR ALL OTHER DAMAGES WILL BE LIMITED TO ONE (1) YEAR'S SERVICE CHARGES. THIS LIMITATION OF LIABILITY IS CUMULATIVE AND NOT PER INCIDENT.~~ SOME STATES OR JURISDICTIONS DO NOT ALLOW THE EXCLUSION OR LIMITATION OF INCIDENTAL OR CONSEQUENTIAL DAMAGES AND IN SUCH EVENT, THE FOREGOING EXCLUSIONS AND LIMITATIONS SHALL ONLY APPLY TO THE EXTENT PERMITTED BY APPLICABLE LAW.

[remainder of page intentionally left blank]

Audio Visual Innovations Inc. and Signal Perfection Ltd are wholly owned subsidiaries of AVI-SPL, Inc. This Entire Document and all information (including drawings, specifications and designs) presented by any subsidiary are the property of AVI-SPL Inc. Proprietary information provided to potential customers, clients or agents is for the sole purpose of demonstrating solutions delivery capabilities and shall be held in confidence. These Materials may not be copied, distributed or disclosed in any way without the sole written permission of an authorized representative of AVI-SPL. © Copyright AVISPL. All Rights Reserved

**ADDENDUM TO AGREEMENT FOR
AUDIO VISUAL SYSTEM EQUIPMENT UPGRADES AND
MAINTENANCE AND SUPPORT BY AND BETWEEN
THE TOWN OF SURFSIDE, FLORIDA, AND
AUDIO VISUAL INNOVATIONS, INC.**

THIS ADDENDUM TO THE AGREEMENT FOR AUDIO VISUAL SYSTEM EQUIPMENT UPGRADES AND MAINTENANCE AND SUPPORT (“Addendum”) is made and entered into as of this ___ day of _____, 2020, by and between **TOWN OF SURFSIDE, FLORIDA**, a Florida municipal corporation (referred to as “Town”, “Buyer”, and/or “Customer”), and **AUDIO VISUAL INNOVATIONS, INC.**, a wholly owned subsidiary of AVI-SPL, Inc., (referred to as “Company” and/or “AVI-SPL”).

WITNESSETH:

WHEREAS, the Town and Company wish to enter into an agreement based on the proposals for (i) Audio Visual and Broadcasting Equipment and Support; (ii) Zoom Integration with the Commission Chambers; (iii) Close Captioning Equipment and Device Maintenance (hereinafter, collectively, the “Agreement”); and

WHEREAS, pursuant to the Agreement, the Company will provide: (i) Audio Visual And Broadcasting Equipment and Support for \$5,177.84; (ii) Zoom Integration with the Commission Chambers for \$9,498.10; and (iii) Close Captioning Equipment and Maintenance for \$77,036.99; and

WHEREAS, the Town and Company desire to amend certain provisions of the Agreement as hereinafter provided.

NOW, THEREFORE, for and in consideration of the mutual promises herein contained, and other good and valuable consideration, the receipt, adequacy and sufficiency of which are hereby acknowledged, the Town and Company desiring to be legally bound, do hereby agree and covenant as follows:

1. **Addendum Controls.** In the event of any conflict between this Addendum and the Agreement, the terms of this Addendum shall prevail and govern.
2. **Defined Terms.** All initial capitalized terms used in this Addendum shall have the same meaning as set forth in the Agreement unless otherwise provided.
3. **Recitals.** The recitals set forth above are incorporated herein and made a part of this Addendum.
4. **Payments.** Company shall deliver an invoice to the Town once the System installation is completed detailing deliverables or services delivered or completed and the amount due to Company under the Agreement. The Town shall pay the Company in accordance with the Florida Prompt Payment Act after approval and acceptance of the deliverables or services by the Town Manager and/or his designee.

5. **Insurance.**

- 5.1 Company shall secure and maintain throughout the duration of this Agreement insurance of such types and in such amounts not less than those specified below as satisfactory to Town, naming the Town as an Additional Insured, underwritten by a firm rated A-X or better by A.M. Best and qualified to do business in the State of Florida. The insurance coverage shall be primary insurance with respect to the Town, its officials, employees, agents and volunteers naming the Town as additional insured. Any insurance maintained by the Town shall be in excess of the Company's insurance and shall not contribute to the Company's insurance. The insurance coverages shall include at a minimum the amounts set forth in this Section 5 and may be increased by the Town as it deems necessary or prudent.
- 5.2 Commercial General Liability coverage with limits of liability of not less than a \$1,000,000 per Occurrence combined single limit for Bodily Injury and Property Damage. This Liability Insurance shall also include Completed Operations and Product Liability coverages and eliminate the exclusion with respect to property under the care, custody and control of Company. The General Aggregate Liability limit and the Products/Completed Operations Liability Aggregate limit shall be in the amount of \$2,000,000 each.
- 5.3 Workers Compensation and Employer's Liability insurance, to apply for all employees for statutory limits as required by applicable State and Federal laws. The policy(ies) must include Employer's Liability with minimum limits of \$1,000,000.00 each accident. No employee, subcontractor or agent of the Company shall be allowed to provide Services pursuant to the Agreement who is not covered by Worker's Compensation insurance.
- 5.4 Business Automobile Liability with minimum limits of \$1,000,000 per Occurrence, combined single limit for Bodily Injury and Property Damage. Coverage must be afforded on a form no more restrictive than the latest edition of the Business Automobile Liability policy, without restrictive endorsements, as filed by the Insurance Service Office, and must include Owned, Hired, and Non-Owned Vehicles.
- 5.5 Professional Liability Insurance in an amount of not less than Two Million Dollars (\$2,000,000.00) per occurrence, single limit.
- 5.6 Cyber Liability Insurance in the amount of Two Million Dollars \$2,000,000.00.
- 5.7 **Certificate of Insurance.** Certificates of Insurance shall be provided to the Town, reflecting the Town as an Additional Insured (except with respect to

Professional Liability Insurance), no later than ten (10) days after award of this Agreement and prior to the execution of the Agreement by Town and prior to commencing any Services. Each certificate shall include no less than (30) thirty-day advance written notice to Town prior to cancellation, termination, or material alteration of said policies or insurance. The Company shall be responsible for assuring that the insurance certificates required by this Section remain in full force and effect for the duration of the Agreement, including any extensions or renewals that may be granted by the Town. The Certificates of Insurance shall not only name the types of policy(ies) provided, but also shall refer specifically to the Agreement and shall state that such insurance is as required by the Agreement. The Town reserves the right to inspect and return a certified copy of such policies, upon written request by the Town. If a policy is due to expire prior to the completion of the Services, renewal Certificates of Insurance shall be furnished thirty (30) calendar days prior to the date of their policy expiration. Each policy certificate shall be endorsed with a provision that not less than thirty (30) calendar days' written notice shall be provided to the Town before any policy or coverage is cancelled or restricted. Acceptance of the Certificate(s) is subject to approval of the Town.

5.8 **Additional Insured.** Except with respect to Professional Liability Insurance, the Town is to be specifically included as an Additional Insured for the liability of the Town resulting from Services performed by or on behalf of the Company in performance of the Agreement. The Company's insurance, including that applicable to the Town as an Additional Insured, shall apply on a primary basis and any other insurance maintained by the Town shall be in excess of and shall not contribute to the Company's insurance. The Company's insurance shall contain a severability of interest provision providing that, except with respect to the total limits of liability, the insurance shall apply to each Insured or Additional Insured (for applicable policies) in the same manner as if separate policies had been issued to each.

5.9 **Deductibles.** All deductibles or self-insured retentions must be declared to and be reasonably approved by the Town. The Company shall be responsible for the payment of any deductible or self-insured retentions in the event of any claim.

5.10 The provisions of this section shall survive termination of the Agreement.

6. **Indemnification.** Company shall protect, defend, indemnify, save and hold harmless the Town, all departments, agencies, boards and commissions, its officers, agents, servants and employees, including volunteers, from and against any and all claims, demands, expense and liability arising out of injury or death to any person or the damage, loss or destruction of any property which may occur or in any way grow out of any negligent act or omission of the Company, its agents, servants, and employees, or any and all costs, expense

and/or attorney fees incurred by the Town as a result of any claim, demands, and/or causes of action. Nothing in this indemnification or the Agreement is intended to act as a waiver of the Town's sovereign immunity rights, including those provided under section 768.28, Florida Statutes. This indemnification shall survive the expiration or termination of the Agreement.

7. **Notices/Authorized Representatives.**

7.1 Any notices required by the Agreement shall be in writing and shall be deemed to have been properly given if transmitted by hand-delivery, by registered or certified mail with postage prepaid return receipt requested, or by a private postal service, addressed to the parties (or their successors) at the following addresses:

For the Town: Town of Surfside
Town Manager
9293 Harding Avenue
Surfside, Florida 33154

With a copy to: Town Attorney
Town of Surfside
9293 Harding Avenue
Surfside, Florida 33154

For The Company: AVI-SPL, Inc.
Attention: Executive Vice President
6301 Benjamin Road, Suite 101
Tampa, Florida 33634

8. **Governing Law.**

The Agreement shall be construed in accordance with and governed by the laws of the State of Florida. Venue for any litigation arising out of this Agreement shall be proper exclusively in Miami-Dade County, Florida.

9. **Ownership and Access to Records; Public Records.** Notwithstanding anything to the contrary in the Agreement, the Agreement and all deliverables and services provided by the Company are subject to Florida's Public Records Law (Chapter 119, Florida Statutes, including but not limited to the following:

9.1 Company acknowledges that all inventions, innovations, improvements, developments, methods, studies, designs, analyses, plans, drawings, reports and all similar or related information (whether patentable or not) which relate to Services to the Town which are conceived, developed or made by Company during the term of the Agreement ("Work Product") belong to the Town. Company shall promptly disclose such Work Product to the Town and perform all actions reasonably requested by the Town (whether during

or after the term of the Agreement) to establish and confirm such ownership (including, without limitation, assignments, powers of attorney and other instruments).

- 9.2 All records, books, documents, maps, data, deliverables, papers and financial information (the "Records") that result from the Company providing the Services to the Town under the Agreement shall be the property of the Town.
- 9.3 Company agrees to keep and maintain public records in Company's possession or control in connection with Company's performance under the Agreement. Company additionally agrees to comply specifically with the provisions of Section 119.0701, Florida Statutes. Company shall ensure that public records that are exempt or confidential and exempt from public records disclosure requirements are not disclosed, except as authorized by law, for the duration of the Agreement, and following completion of the Agreement until the records are transferred to the Town.
- 9.4 Upon request from the Town custodian of public records, Company shall provide the Town with a copy of the requested records or allow the records to be inspected or copied within a reasonable time at a cost that does not exceed the cost provided by Chapter 119, Florida Statutes, or as otherwise provided by law.
- 9.5 Unless otherwise provided by law, any and all records, including but not limited to reports, surveys, and other data and documents provided or created in connection with this Agreement are and shall remain the property of the Town.
- 9.6 Upon completion of this Agreement or in the event of termination by either party, any and all public records relating to the Agreement in the possession of the Company shall be delivered by the Company to the Town Manager, at no cost to the Town, within seven (7) days. All such records stored electronically by Company shall be delivered to the Town in a format that is compatible with the Town's information technology systems. Once the public records have been delivered upon completion or termination of this Agreement, the Company shall destroy any and all duplicate public records that are exempt or confidential and exempt from public records disclosure requirements.
- 9.7 Any compensation due to Company shall be withheld until all records are received as provided herein.
- 9.8 Company's failure or refusal to comply with the provisions of this section shall result in the immediate termination of the Agreement by the Town.

Section 119.0701(2)(a), Florida Statutes

IF THE COMPANY HAS QUESTIONS REGARDING THE APPLICATION OF CHAPTER 119, FLORIDA STATUTES, TO THE COMPANY’S DUTY TO PROVIDE PUBLIC RECORDS RELATING TO THIS AGREEMENT, CONTACT THE CUSTODIAN OF PUBLIC RECORDS.

Custodian of Records: SANDRA NOVOA, MMC,
TOWN CLERK

Mailing address: 9293 Harding Avenue
Surfside, Florida 33154

Telephone number: 305-887-9541

Email: snova@townofsurfsidefl.gov

10. **Compliance with Laws.**

Company shall comply with all applicable laws, ordinances, rules, regulations, and lawful orders of public authorities in carrying out deliverables or services under the Agreement, and in particular shall obtain all required permits from all jurisdictional agencies to perform the services under the Agreement.

11. **Most Favored Nation.**

Company agrees that if, after the Effective Date of the Agreement, it enters into an agreement for the same or substantially similar scope of services with another local government in Florida which contains a term or condition, including fees, charges or costs, that are more favorable than the terms in the Agreement, the Town may provide Company with written notice explaining how the new agreement is for the same or substantially similar services and how the new agreement contains terms or conditions that are more favorable than the terms in the Agreement, and requesting to negotiate an amendment to the Agreement (a “New Agreement Notice”). The parties shall act in good faith to negotiate an amendment to the Agreement that addresses, in a manner that is fair and equitable to both parties, the matters raised by the Town in the New Agreement Notice. If the parties fail to reach agreement upon an amendment within ninety (90) days of the New Agreement Notice, then the Town shall have the right to terminate this Agreement without penalty or early termination fee. .

12. **Ratification.** Except as expressly amended herein, all of the terms and provisions of the Agreement remain unmodified and in full force and effect. In the event of any conflict between the terms of the Agreement and the terms of this Addendum, the terms of this Addendum shall govern as necessary to resolve any such conflict.

13. **Controlling Agreement; No Construction against Drafter.** The Agreement, as

modified by this Addendum, is the sole expression of the agreement between the Town and Company as to the subject matter thereof.

14. **Counterparts, Facsimiles.** This Addendum may be executed in counterparts and any counterpart evidencing signature by one party may be delivered by telecopy, facsimile or electronic mail. Each executed counterpart of this Addendum will constitute an original document and all executed counterparts, together, will constitute the same Agreement.

IN WITNESS WHEREOF, the parties hereto have caused this Addendum on the dates set forth below their respective signatures.

TOWN:

TOWN OF SURFSIDE, FLORIDA, a Florida municipal corporation

By: _____

Name: _____

Title: _____

Date: _____

ATTEST:

Town Clerk

APPROVED AS TO LEGAL FORM AND SUFFICIENCY:

Town Attorney

COMPANY:

AUDIO VISUAL INNOVATIONS, INC.

By: _____

Name: _____

Title: _____

Date: _____



MEMORANDUM

ITEM NO. 2B

To: Honorable Mayor, Vice-Mayor and Members of the Town Commission
From: Guillermo Olmedillo, Town Manager
Date: June 10, 2020
Subject: Sand Dollar Key Tot Lot and Waterslide Renovations

The Town of Surfside completed construction on the Community Center Sand Dollar Key Water Tot Lot and main pool Waterslide in 2011. The Water Tot Lot consists of a play structure with two slides and numerous water features. The main pool Waterslide is a two-story open flume slide. Due to the usage, wear and tear, and oceanfront location, the metal has begun to deteriorate due to rust. Additionally, due to the rust, apparatuses on Tot Lot need to be removed and repaired for safety concerns. In order to continue to keep all three slides operational, renovations must be completed before damage is beyond repair. The recommendation of rust prevention on slide structures is suggested approximately every 5 to 8 years.

The Main Pool and Tot Lot is host to many users and gets thorough use at the Community Center. Preventative upkeep of the facility is imperative to help eliminate any long-term issues and assist with preserving the long-term investment and quality of the facility. Twice a year the slide is inspected by both a structural engineer and by the Florida Health Department Fair Rides Bureau. Completing this preventative maintenance will eliminate the potential shut down from the inspection and will allow for continued permits from the state.

The work will include a gel coat, structural repairs, polish and wax and painting. The restoration will take approximately five to seven business days once the work begins. Proper notices and advertisement will be distributed and posted. This time frame is crucial, not only for the completion of the work, but also the time necessary for the work to cure correctly. Winter months are the best time to complete this project because the pool usage is lowest during that time.

Safe Slides Restoration came highly recommended from two nearby municipalities – City of Largo and Collier County. There are few slide restoration companies that repair both fiberglass slides in addition to the surrounding metal work (such as that on the water Tot

Reviewed by: AH/TM

Prepared by: EH

Lot). Staff were able to compile three estimates, see Attachments A, B, and C. Safe Slide Restoration was selected out of these quotes being the lowest price at \$38,900 and having reputable references.

Staff request Commission approval of the resolution authorizing the contract for the slide restoration in the amount of \$38,900. The work was budgeted for \$47,500 in Parks and Recreation Department under the Community Center Tourist Resort Tax, account 102-8000-572-46-02 for Fiscal Year 2020.

Reviewed by: AH/TM

Prepared by: EH



Elizabeth Hopkins
 Parks and Recreation Aquatic Supervisor
 9293 Harding Ave.
 Surfside, FL 33154
 305-866-3635 ext 219
 ehopkins@townofsurfsidefl.gov

Thank you for allowing Anderson Aquatics to provide you with a quote for your slide reconditioning project. We look forward to working with you to restore your slide.

I. MAINTENANCE & RESTORATION SERVICES

- Interior Recoat of Open Flume Blue Slide.
- Sand interior surface, repair all cracks, grind down all seams and prepare for re-caulk
- Gel Coat interior surface up to 20 mil thickness
- Caulk all seams
- Clean site and remove all restoration materials
- Prep and paint exterior of Open Blue Slide and Gel Coat interior slide \$22,100
- Paint Exterior of Slide Tower \$17,700
- Gel Coat interior of Blue Double wide Open Waterslide \$6,000
- Paint Exterior of Dumping Bucket feature \$15,800
- Prep and Gel Coat Blue slide, Paint Slide Tower, Gel Coat Double wide slide, Paint Dumping Bucket feature.** **\$61,600**

Cost includes a one (1) year warranty against chipping, flaking and color fading of interior coating.

TIME FRAME:

Allow 10+14 days for completion of project

TOTAL COST:

III. PAYMENT TERMS

- 50% Due to initiate contract and order materials
- 50% Due upon completion of on-site work. Payment due upon receipt of invoice.

Anderson Aquatics 2523 Baneberry Way Highlands Ranch CO 80129 303-791-7927
 Brad Anderson
 Owner



Proposal with Terms and Conditions
Pricing valid if contract signed within (30) days.

May 20, 2020

Elizabeth Hopkins
Parks and Recreation Aquatic Supervisor
9293 Harding Avenue
Surfside, FL 33154
305-866-3635 Ex 219
ehopkins@townofsurfsidefl.gov

Liz,

Thank you for the opportunity to present our renovation proposal. The Slide Experts looks forward to working with City of Surfside Florida to determine your park's current and future needs and to demonstrate our excellent services.

The Slide Experts is the expert in the Waterpark Industry to restore and maintain Water Slides, Structures and Pools. The Owner, with over 25 years of experience in the Service and Restoration Industry, will be on site to execute this project. Our web site explains everything we do www.theslideexperts.com

Objective:

The Slide Experts objective is to Clean, Repair, Sand, Caulk, Paint Exterior and Gel Coat Interior of your (1) Open Waterslide, Paint (1) Slide Tower, Gel Coat (1) Double Wide Open Waterslide, Paint (1) Water Feature, bringing you're slide and structure surfaces back to a quality finish. Below we will show Pictures, Scope of Work, Time Frame, Cost and Terms and Conditions to complete this Project.

Pictures:

Gel Coat Interior and Paint Exterior of (1) Blue and White Open Waterslide. Paint (1) Slide Tower. Gel Coat Interior of (1) Blue Double Wide Kiddy Open Waterslide. Paint (1) Water Feature with Dumping Bucket.

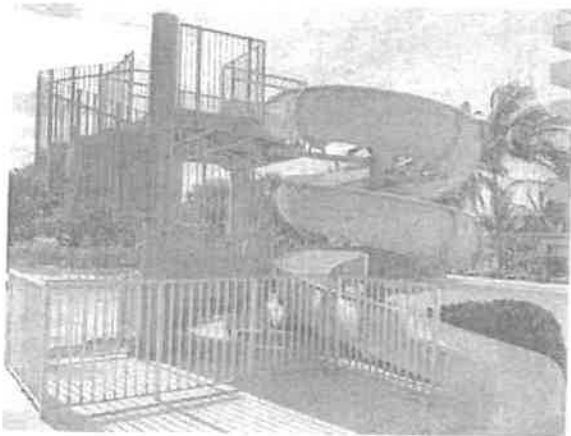

Scope of Work:

- Sand, repair, caulk and gel coat interior of (1) Blue Open Waterslide.
- Sand, repair, caulk and gel coat interior of (1) Blue Double Wide Waterslide.
- Sand entire gel coated surface to a 1 mil profile. The key here is experience; new gel coat can easily be damaged if the surface is not sanded properly. Chemical contaminants and old gel coat must be removed prior to new coating being applied.
- Repair minor cracks, chips and damage along the ride path only of the water slide. *Major repairs will require an additional quote.*
- Grind open tight seams to allow for caulking. Remove existing caulking so new gel coating adheres to fiberglass only and not loose flakes of old caulking.
- Apply 20 + mils of gel coat to interior riding surfaces on your water slides. It takes experience to get the right mixture of gel coat, additive, catalyst and air. The Slide Experts knows this process to ensure a quality finish that will last for years.
- Caulk all seams on with Sikaflex 1A. Caulking will be white unless another color is requested. Colors are limited.
- Paint (1) Slide Tower, steel only. Grind Off all Rust.
- Paint (1) Water Feature with Dumping Bucket, steel only. Grind Off all Rust.
- The Slide Experts will help train park employees to better maintain their water slides and other water features.
- The Slide Experts and our trained technicians will be on site to execute your project from start to finish. The Slide Experts is the leader in our industry for water slide restoration. The Slide Experts extensive 25 years of experience sets us apart from the competition with real experience on coatings and paint.
- Includes all labor, supervision, rental equipment and materials.
- One (1) year warranty against chipping or flaking on interior and exterior coatings, including materials and labor. If proper prep work is completed on your water slides there will be no failures in the first year or years to follow. If a failure is to occur it will happen immediately, due to improper prep work. No warranty on caulking or leaks.

Time Frame:

- 10-14 working days to complete Restoration Project.

Total Cost for Restoration Project:

- | | |
|---|------------------------|
| ▪ Gel Coat Interior and Paint Exterior of (1) Blue Open Waterslide. | Sub Total: \$18,500.00 |
| ▪ Paint Exterior of (1) Slide Tower. | Sub Total: \$15,000.00 |
| ▪ Gel Coat Interior of (1) Blue Double Wide Open Waterslide. | Sub Total: \$5,000.00 |
| ▪ Paint Exterior of (1) Water Feature with Dumping Bucket. | Sub Total: \$13,500.00 |
| ▪ Total Restoration Project Cost: | Total: \$52,000.00 |

Terms:

- 50% Due upon signing of Terms and Conditions: *(No project is added to work schedule until Deposit is received.)*
- 50% Due upon completion of Project with final walk through with Client.

The Slide Experts would like to thank you in advance for this opportunity. We look forward to working with you on this and any future projects. If you should have any questions or need further information, please do not hesitate to call me at 720-940-0106 or email me at jim@theslideexperts.com

Regards,



Jim Gardiner
Owner/Sales
720-940-0106
www.theslideexperts.com

TERMS AND CONDITIONS

1. **VALIDITY OF OFFER:** Buyer shall indicate acceptance of this Agreement by returning a copy of this Agreement signed by a duly authorized representative of Buyer. If Buyer has not yet indicated acceptance of this Agreement, The Slide Experts offer to perform under the Agreement shall terminate on the earlier of (I) The Slide Experts notification (whether verbal or written) to Buyer that such offer has been terminated, (II) thirty (30) days after the contract date listed on page 1 of this Agreement, or (III) thirty (30) days after Buyer's receipt of this Agreement. The Slide Experts will walk the water park and go over Scope of Work on the first day with Client. Anything out of the ordinary outside the agreed Scope of Work will be negotiated and additional fees may apply at that time.
2. **SCHEDULE OF DELIVERY:** The Slide Experts will use best efforts to provide the Deliverables in accordance with the schedule, but does not guarantee such schedule. Time is not of the essence in this Agreement and The Slide Experts is not liable for any lost profits or consequential damages suffered by Buyer or any third party for any reason. If there is a change in the scope of work or if The Slide Experts falls behind schedule due to the actions of Buyer or any third party, the parties will adjust the schedule to afford The Slide Experts a reasonable opportunity to perform the outstanding work. The Buyer may request adjustments or additions to this project. Upon receipt of the written request for adjustment or additions, The Slide Experts will provide the Buyer with an adjusted proposal. The Slide Experts requires both parties to sign the change order and to update the contract to reflect the change request. No work will occur until the change order is approved in writing by the buyer.
3. **PROJECT REQUIREMENTS:** The Slide Experts assumes responsibility for all statutes, codes, and/or regulations that pertain to the Scope of Work, and will perform the work in compliance with all such requirements. The Slide Experts will, if required obtain any and all permits pertaining to the Scope of Work. It is The Slide Experts intention to complete the project on schedule and within budget. Client will have someone in a management position be available for the final walk through and be authorized to sign and approve the final walk through sheet. Unless otherwise specifically noted in the Scope of Work, The Slide Experts is expecting the following services and amenities to be freely available:
 - 1) Restroom facilities.
 - 2) Water with at least 40 lbs. of pressure within 50 feet of project.
 - 3) 110 electric service within 50 feet of project.
 - 4) Clear and reasonable access to the project area.
 - 5.) Pools to be drained and/or generally clean upon arrival of our crew.
 - 6.) It is expected that our crews shall work from 8 am to 8 pm seven (7) days a week as we deem necessary and we expect reasonable cooperation in making the facility available to them at no extra cost to us (e.g. weekend and / or early am work).
 - 7) Provide parking for our vehicles at no charge to The Slide Experts.
4. **TAXES AND/OR DUTIES:** Any tax, tariff or duty imposed by law on articles sold or rented or any services rendered by The Slide Experts, shall be the responsibility of Buyer and in addition to the sales price hereof.
5. **PAYMENT TERMS:** Buyer agrees to pay The Slide Experts the fees in accordance with the terms set forth in this Agreement. The Slide Experts standard terms are 50% of total payment due upon signing of contract and 50% final payment due upon final walk through approved by client. Past due balances will be billed a service charge of 2% per month (or if 2% is illegal under applicable law, the maximum permitted rate) beginning the day after payment is due. Buyer agrees to pay all associated court costs, collection charges and expenses that are incurred by The Slide Experts in collection efforts, including, without limitation, all attorney's fees and expenses, and all costs of repossession and resale. Amounts owed under this Agreement may not be set off or offset by other obligations of the parties for any reason. If Buyer cancels or defaults on this Agreement, Buyer will pay to The Slide Experts the greater of (I) any and all deposits paid to The Slide Experts to be paid by forfeiture of such amounts, and (II) all direct and indirect costs incurred by The Slide Experts in performing under this Agreement, plus a 20% handling fee.
6. **WARRANTY:** The Slide Experts warrants all of its work will be free from defects in material and workmanship under normal use and service with proper maintenance for a period of 12 months from the date of service or installation. Full payment of project has to be meant to start the one year warranty. If The Slide Experts work is found to be defective within this time period, The Slide Experts will provide the labor and materials to repair the defects. Certain products and material warranties are provided by others and will be subject to their respective terms. **THE EXPRESS WARRANTIES CONTAINED IN THIS PARAGRAPH ARE BUYER'S SOLE AND EXCLUSIVE REMEDIES AND ARE IN LIEU OF ANY AND ALL OTHER WARRANTIES, EXPRESS OR IMPLIED, INCLUDING ANY IMPLIED WARRANTY OF MERCHANTABILITY OR FITNESS FOR A PARTICULAR PURPOSE. BUYER ACKNOWLEDGES THAT IT IS NOT RELYING UPON THE SLIDE EXPERTS SKILL AND JUDGMENT TO SELECT OR FURNISH GOODS SUITABLE FOR ANY PARTICULAR PURPOSE AND THAT THERE ARE NO WARRANTIES THAT ARE NOT CONTAINED IN THIS AGREEMENT. THE SLIDE EXPERTS SHALL NOT BE LIABLE FOR DAMAGES, INCLUDING SPECIAL, INCIDENTAL, OR CONSEQUENTIAL DAMAGES, ARISING OUT OF OR IN CONNECTION WITH THE PERFORMANCE OF THESE SERVICES OR THEIR USE BY BUYER. THESE WARRANTIES SHALL NOT APPLY TO PRODUCTS THAT HAVE BEEN USED IN A MANNER OUTSIDE OF THE GUIDELINES SUGGESTED BY THE SLIDE EXPERTS OR THAT HAVE BEEN SUBJECT TO ANY MISUSE OR ABUSE, MISAPPLICATION, REPAIR OR TAMPERING IN ANY WAY AS TO AFFECT PERFORMANCE. THERE IS NO WARRANTY ON CAULKING AND LEAKS.**
7. **INCORPORATION OF SAFETY INFORMATION:** Buyer acknowledges receipt of any and all written safety and operational information from original equipment manufacturer related to the safe use of the equipment including, without limitation, information related to installation, location, maintenance, use, safety surfacing and warning signs verbiage. The Slide Experts will provide Buyer with any and all such safety and operational information regarding the products and services (Deliverables) listed in the Scope of Work. Buyer further acknowledges that it has reviewed all such safety information and hereby indemnifies releases and discharges The Slide Experts from and against any and all liabilities, costs or expenses of injuries or damages to any third party as a result of any use of the equipment and Deliverables that is not in accordance with such safety information.
8. **LIMITATION OF LIABILITY:** Except for the indemnification obligations, neither party is liable to the other for consequential, incidental, direct, indirect or special damages, including commercial loss and lost profits, however caused, in excess of the fees paid under this Agreement.

9. **OWNERSHIP OF INTELLECTUAL PROPERTY:** *The Slide Experts will be the sole owner or obtain any and all permissions of use from such owner, of all intellectual property rights embodied in or related to the scope of work. The Slide Experts will also own or obtain any and all permissions of use for any derivative works, improvements, alterations or modifications conceived by The Slide Experts or any of its employees, consultants or agents. If the scope of work requires The Slide Experts to incorporate a trademark or other intellectual property owned by Buyer or a third party, The Slide Experts will provide a written statement from the Buyer or third party of such intellectual property consenting to its use in the scope of work. Upon the executing of this document, Buyer transfers any and all rights regarding any and all photographic or artistic representations produced by The Slide Experts of the project before, during or after completion of the project for their exclusive use in The Slide Experts sales and marketing efforts or in any other activity The Slide Experts deems appropriate.*
10. **INDEMNIFICATION:** *Buyer will indemnify and hold harmless The Slide Experts, its parent, subsidiaries, affiliates, agents, shareholders, directors, and employees from and against all damages, costs and liabilities (including reasonable attorney's fees and expenses) arising from or related to the actions or inaction of Buyer, its agents and employees and others under its direction or control in conjunction with the operation of the scope of work, the Deliverables and installation.*
11. **CONFIDENTIALITY:** *"Confidential Information" means any and all business, technical or third party information (including without limitation specifications, drawings, sketches, models, samples or documentation) marked as confidential or proprietary (or which a party knows or has reason to know is proprietary) and provided, disclosed, or made available under this Agreement. The parties shall restrict access to the Confidential Information to employees or agents who have a "need to know." The parties, employees, or agents shall not disclose the Confidential Information to any third party and shall treat the Confidential Information in the same way it treats its own Confidential Information of like kind. This provision will not apply to information which is in the public domain, is previously known to the receiving party without obligation of confidentiality, and is independently developed by the receiving party from a third party that does not have an obligation to keep the information confidential.*
12. **NOTICES:** *Notices required under this Agreement shall be sent to the addresses of the parties stated on page 1 of the Sales Agreement. Notices will be deemed given (a) when delivered, if sent by registered or certified mail (return receipt requested), (b) when delivered, if delivered personally.*
13. **GOVERNING LAW; VENUE:** *The laws of the State of Colorado shall govern the construction and interpretation of this Agreement without giving effect to any choice or conflict of law provisions (whether of the State of Colorado or any other jurisdiction) that would cause the application of the laws of any jurisdiction other than the State of Colorado. Buyer hereby consents and submits to the jurisdiction of the state and federal courts located in Colorado for any dispute related to this Agreement. Any lawsuit or litigation initiated by either party and related to this Agreement shall occur in the appropriate state or federal court located in Parker, Colorado and Buyer and The Slide Experts agree that suit shall not be brought in any other jurisdiction or location; provided however, nothing contained in this Section shall prohibit The Slide Experts from pursuing lien claims, bond claims, repossession actions or injunctive relief in any appropriate jurisdiction or court.*
14. **FORCE MAJEURE:** *Neither party is responsible to the other for failure to conform to this Agreement arising from causes beyond its reasonable control, including, but not limited to, labor disputes, unforeseeable delays during shipment, acts of terrorism, floods, civil commotion, war, riot, acts of God, fires, and embargoes.*
15. **WAIVER:** *The failure of Either Party to insist upon strict performance of any of the terms of this Agreement or to exercise any rights conferred in this Agreement, shall not be construed as a waiver or relinquishment of the right to assert or rely upon any such terms or rights at any future occasion.*
16. **ASSIGNMENT:** *The rights and obligations under this Agreement may not be assigned without the prior written consent of the non-assigning Party; provided however, that The Slide Experts may assign its rights and obligations under this Agreement to an affiliate or pursuant to a sale of substantially all of the assets or ownership of The Slide Experts.*
17. **ENTIRE AGREEMENT:** *This Agreement (including the Master Terms and Conditions) is intended to be the final, complete and exclusive expression of the Agreement between the parties. This Sales Agreement supersedes any and all prior written or oral agreements relating to the subject matter hereof. No modification of this Agreement shall be effective except by a written Agreement expressly stating the parties' intent to so modify this Agreement and signed by the parties. No modification of any provision of this Agreement shall be considered a waiver, breach, or cancellation of any other provision of this Agreement. Any provision in the Sales Agreement that is not consistent with the Master Terms and Conditions in this Exhibit A shall be void and not a part of this Sales Agreement.*

APPROVED AND ACCEPTED:

Seller: The Slide Experts, Inc.

Buyer:

Title: Owner

Title:

Print Name: James Gardiner

Print Name:

Signature:

Signature:

Date:

Date:

Safe Slide Restoration

"Restoring Confidence In Your Slide."

Dale Cooper LLC DBA Safe Slide Restoration
P.O. Box 186, Fredericktown, MO 63645
855.639.7543
www.safeslides.com

December 12th, 2018

Town of Surfside, Parks and Recs / Elizabeth Hopkins
9293 Harding Avenue / Surfside, FL 33154
Phone: 305-905-7380 / ehopkins@townofsurfsidefl.gov

Hello Elizabeth,

The following is a proposal for the restoration of your water slides and slide towers. This proposal is based on the inspection Safe Slide Restoration did on November 8, 2018. Our company is certified in fiberglass composites by the American Composite Manufacturer's Association (ACMA). We have over **20-years** of experience working with fiberglass and gel coat.

We Have The Industry's Best Warranties

- There is a **5 - year warranty** on the paint for adhesion.
- There is a **5 - year warranty** on the structural fiberglass repair not to delaminate.
- There is a **5 - year warranty** on the gel coat. With yearly maintenance plan



Unique Restoration System

Products

Superior Products
Industry Proven
Chosen by Performance not Price

Processes

Documented Procedures
Consistent & Standards
Safety Standards
Proper PPE

People

Unmatched Certifications
ACMA, NACE, OSHA, Non-Slip
Experience: 120 Projects Last Year

Guarantees

All Project Managers are ACMA Certified
Gel Coat Thickness Meets OEM Standards
Meeting Deadlines
Responsive

Slide Description:

Open Flume Body Slide – White Interior, Light Green Exterior
Family Body Slide – Turquoise Green
Closed Flume Child Slide - White Interior, Light Green Exterior
Two Slide Structures - Grey

Work Description:

Gel Coat – Interior of Family Body Slide:

- Repair all minor structural repairs in ride path* (minor repair does not require laminating)
- All repairs will be done with vinyl-ester resin
- Prepare interior ride path for Gel Coat
- Lay non-skid at start tub if needed
- Refinish interior ride path of slide with Gel Coat
- Gel Coat will be applied to a thickness of 18 - 24 mils.
- Premium Gel Coat will be used
- Recaulk all seams (recaulking is not a guarantee to stop leaking seams) **
- Seams will be sealed with premium caulk
- Gel coat RAL color: _____ INIT: _____

Structural Repairs - (As Needed On All 3 Slides):

- Repair all structural repairs in ride path*
- All repairs will be done with vinyl-ester resin
- Recaulk seams as needed (recaulking is not a guarantee to stop leaking seams) **
- Seams will be sealed with premium caulk
- Non-slip will be chemically washed, if needed

Polish and Wax – (Interior of Open Flume Body Slide, :

- Clean start tubs and all open flume sections
- Polish start tubs and all open flume sections
- Wax start tubs and all open flume sections

Paint – (Exterior of Open Flume Body Slide, Child Slide and Metal Components of 2 Slide Towers):

- Wash exterior of slide with cleaner
- Prime-coat bare areas as needed
- Paint exterior with Poly - Siloxane Paint
- > Paint RAL color: _____ INIT: _____

Total Project Amount: ...

838 900 00

We at Safe Slide Restoration are committed to quality and customer satisfaction. We are an international company that provides services to the largest water parks and cruise lines in the world. We look forward to putting our expertise to work for you. Please feel free to call our office at 855-639-7543 or my cell at 989-954-6235 if you have any questions or comments.

Thank you for your consideration, we appreciate your time!

Sincerely,
Joshua Lones
Field Safety Inspector
joshua@safeslides.com

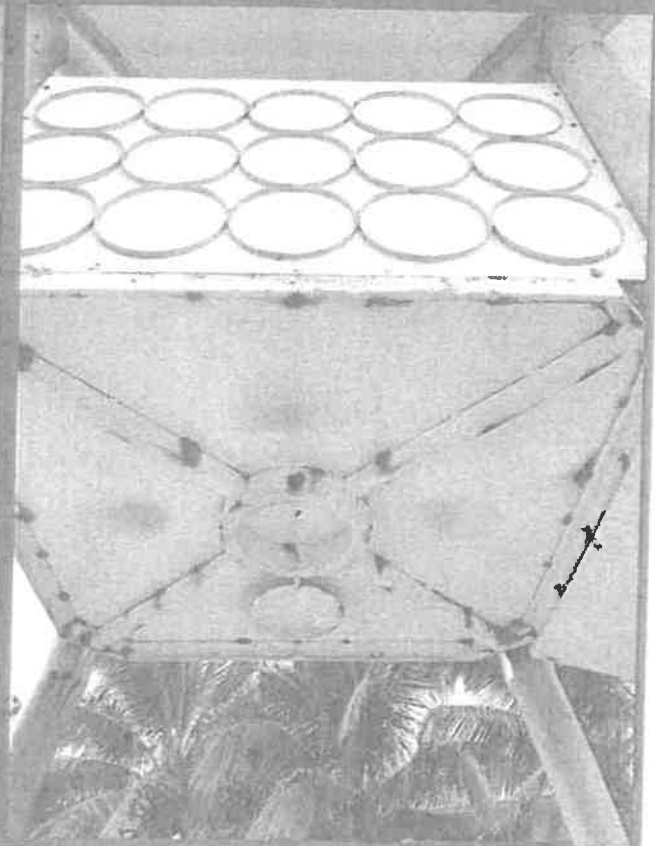
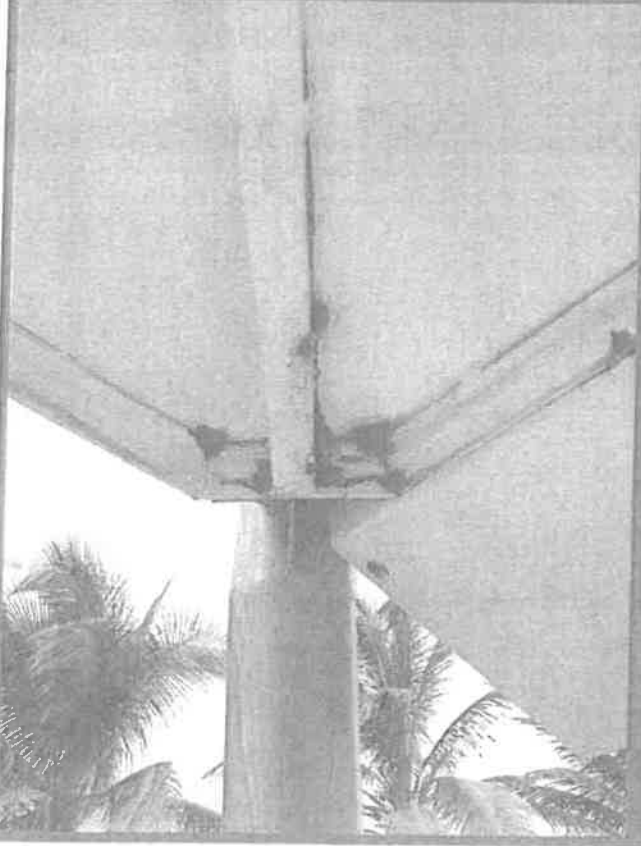
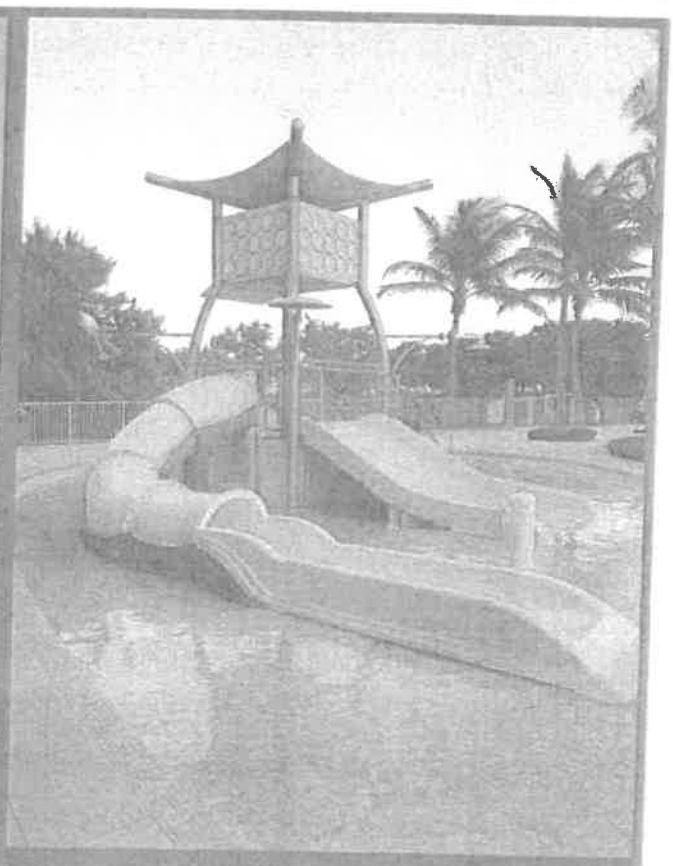
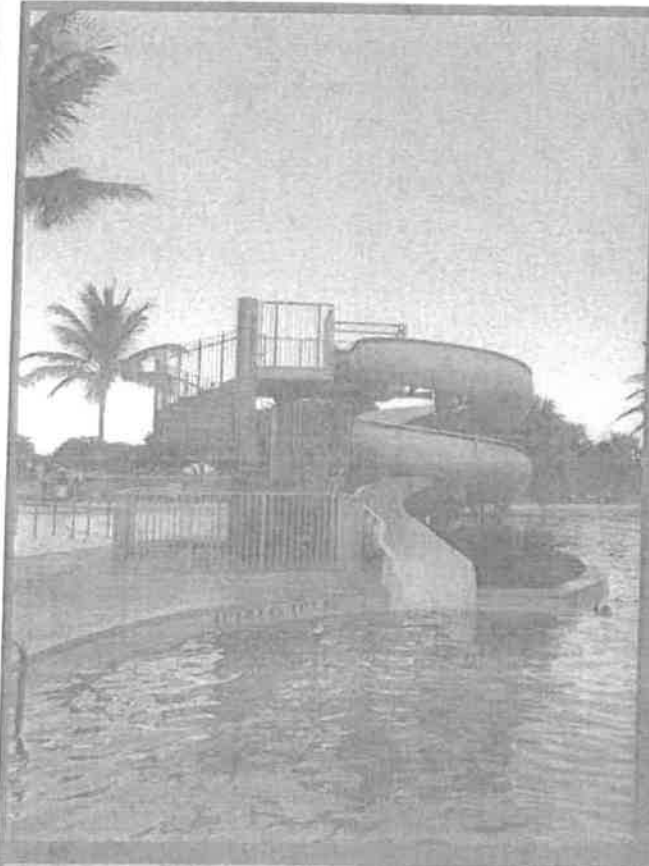

Terms & Conditions

***Structural repair is defined as any damage that is an obvious threat to the guests, (i.e. a chip or gouge with a sharp edge). This is not to be confused with cosmetic repair, (i.e. a spider crack with no flaking or raised edge). This does not include any major repairs that require fiberglass cloth and resin lamination.**

**** Because of the restrictions of our caulk being able to adhere to joints without the proper amount of surface area, we require that the seams are 3/16" wide to caulk them (If the seams to tight the caulk will not adhere).**

Customer Expectations

Safe Slide Restoration reserves the right to have adequate access to the project area to complete the project as efficiently as Safe Slide Restoration deems necessary. This may require, but not limited to: working 12 hours per day / seven days a week. The park is responsible to provide an adequate water source (5 gallons per minute), electrical power (multiple circuits will be needed), and restroom facilities for the duration of the job. If there are any chip repairs and gel coat is required; we are capable of doing in field color-matching for gel coat. Safe Slide technicians will tint the gel coat to match the existing gel coat (This is not to be confused with manufacturer's exact color matching). Customer has the right to request a draw down if request is made 45 days before Safe Slide arrives. Recaulking seams does not apply if the seams are fiberglassed over. If legal proceedings are necessary, they will have to be carried out in Madison County, Missouri.

Customer Responsibilities

If we are repairing leaking seams the customer is responsible for identifying the leaking seams by labeling seams on the interior and exterior of slide (we recommend using a permanent marker in the ride path to label seams). Customer is responsible for identifying areas where lift cannot operate. If a lift is needed, we are not responsible for any broken concrete, landscaping, etc. Safe Slide may request the removal of fencing to allow a lift to access the water slide area (if there isn't access through gate opening). Customer is responsible for providing waste removal. The customer is required to provide access to restrooms for entirety of project. A walk through of finished work as well as a sign-off is required before our staff leaves the job site. Missing the post project walk through is equivalent to an approved sign off by the customer. Safe Slide Restoration will not be responsible for unscheduled return work in the case that the customer misses scheduled post project walk-through and subsequent sign-off.

Possible Additional Charges/Non-Warranty Items

We do not warranty wet coring or wet substrates. There will be an additional charge for interior or exterior failed coatings. If there are any previous interior or exterior coatings; Safe Slide Restoration does not warranty any substrates previously coated after the manufacturer's original coating, or any previous repairs. The pricing above does not include the cost of state taxes, licenses, or permits if required. Sometimes slides require a second coat of paint to achieve the desired finish. If a second coat of paint is required there will be an additional charge of 50% of the original paint price. A 2-3-point Tie-off system on top portion of closed flume slide may be needed if a lift is inaccessible. A cost of \$90 per panel will be assessed and tie offs will stay in place for customer use. An additional daily fee may be assessed if the project site is compromised due to negligence of customer or persons under the customer's control of on said project site. If the customer does not show up and needs to postpone the post job walk through, there will be an additional charge for the delay. This will be determined by how long Safe Slide must stay on site in order to get the walk-through and sign-off which is required before our staff leaves the site. **The cost of a lift is not included in the above pricing.** If a lift is required, it will be the responsibility of the park to provide.

Confidentiality Agreement

The information in this document is confidential to the person to whom it is addressed and should not be disclosed to any other person. It may not be reproduced in whole, or in part, nor may any of the information contained therein be disclosed without the prior written consent of the directors of Safe Slide Restoration.



Elizabeth Hopkins
 Parks and Recreation Aquatic Supervisor
 9293 Harding Ave.
 Surfside, FL 33154
 305-866-3635 ext 219
 ehopkins@townofsurfsidefl.gov

Thank you for allowing Anderson Aquatics to provide you with a quote for your slide reconditioning project. We look forward to working with you to restore your slide.

I. MAINTENANCE & RESTORATION SERVICES

- Interior Recoat of Open Flume Blue Slide.
- Sand interior surface, repair all cracks, grind down all seams and prepare for re-caulk
- Gel Coat interior surface up to 20 mil thickness
- Caulk all seams
- Clean site and remove all restoration materials
- Prep and paint exterior of Open Blue Slide and Gel Coat interior slide \$22,100
- Paint Exterior of Slide Tower \$17,700
- Gel Coat interior of Blue Double wide Open Waterslide \$6,000
- Paint Exterior of Dumping Bucket feature \$15,800
- Prep and Gel Coat Blue slide, Paint Slide Tower, Gel Coat Double wide slide, Paint Dumping Bucket feature.** **\$61,600**

Cost includes a one (1) year warranty against chipping, flaking and color fading of interior coating.

TIME FRAME:

Allow 10+14 days for completion of project

TOTAL COST:

III. PAYMENT TERMS

- 50% Due to initiate contract and order materials
- 50% Due upon completion of on-site work. Payment due upon receipt of invoice.

Anderson Aquatics 2523 Baneberry Way Highlands Ranch CO 80129 303-791-7927
 Brad Anderson
 Owner



Proposal with Terms and Conditions
Pricing valid if contract signed within (30) days.

May 20, 2020

Elizabeth Hopkins
Parks and Recreation Aquatic Supervisor
9293 Harding Avenue
Surfside, FL 33154
305-866-3635 Ex 219
ehopkins@townofsurfsidefl.gov

Liz,

Thank you for the opportunity to present our renovation proposal. The Slide Experts looks forward to working with City of Surfside Florida to determine your park's current and future needs and to demonstrate our excellent services.

The Slide Experts is the expert in the Waterpark Industry to restore and maintain Water Slides, Structures and Pools. The Owner, with over 25 years of experience in the Service and Restoration Industry, will be on site to execute this project. Our web site explains everything we do www.theslideexperts.com

Objective:

The Slide Experts objective is to Clean, Repair, Sand, Caulk, Paint Exterior and Gel Coat Interior of your (1) Open Waterslide, Paint (1) Slide Tower, Gel Coat (1) Double Wide Open Waterslide, Paint (1) Water Feature, bringing you're slide and structure surfaces back to a quality finish. Below we will show Pictures, Scope of Work, Time Frame, Cost and Terms and Conditions to complete this Project.

Pictures:

Gel Coat Interior and Paint Exterior of (1) Blue and White Open Waterslide. Paint (1) Slide Tower. Gel Coat Interior of (1) Blue Double Wide Kiddy Open Waterslide. Paint (1) Water Feature with Dumping Bucket.

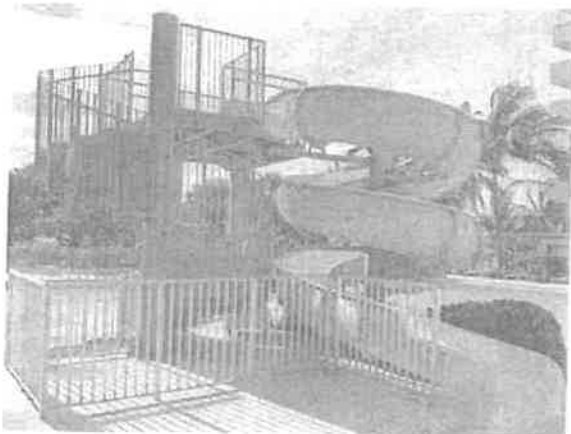

Scope of Work:

- Sand, repair, caulk and gel coat interior of (1) Blue Open Waterslide.
- Sand, repair, caulk and gel coat interior of (1) Blue Double Wide Waterslide.
- Sand entire gel coated surface to a 1 mil profile. The key here is experience; new gel coat can easily be damaged if the surface is not sanded properly. Chemical contaminants and old gel coat must be removed prior to new coating being applied.
- Repair minor cracks, chips and damage along the ride path only of the water slide. *Major repairs will require an additional quote.*
- Grind open tight seams to allow for caulking. Remove existing caulking so new gel coating adheres to fiberglass only and not loose flakes of old caulking.
- Apply 20 + mils of gel coat to interior riding surfaces on your water slides. It takes experience to get the right mixture of gel coat, additive, catalyst and air. The Slide Experts knows this process to ensure a quality finish that will last for years.
- Caulk all seams on with Sikaflex 1A. Caulking will be white unless another color is requested. Colors are limited.
- Paint (1) Slide Tower, steel only. Grind Off all Rust.
- Paint (1) Water Feature with Dumping Bucket, steel only. Grind Off all Rust.
- The Slide Experts will help train park employees to better maintain their water slides and other water features.
- The Slide Experts and our trained technicians will be on site to execute your project from start to finish. The Slide Experts is the leader in our industry for water slide restoration. The Slide Experts extensive 25 years of experience sets us apart from the competition with real experience on coatings and paint.
- Includes all labor, supervision, rental equipment and materials.
- One (1) year warranty against chipping or flaking on interior and exterior coatings, including materials and labor. If proper prep work is completed on your water slides there will be no failures in the first year or years to follow. If a failure is to occur it will happen immediately, due to improper prep work. No warranty on caulking or leaks.

Time Frame:

- 10-14 working days to complete Restoration Project.

Total Cost for Restoration Project:

- | | |
|---|------------------------|
| ▪ Gel Coat Interior and Paint Exterior of (1) Blue Open Waterslide. | Sub Total: \$18,500.00 |
| ▪ Paint Exterior of (1) Slide Tower. | Sub Total: \$15,000.00 |
| ▪ Gel Coat Interior of (1) Blue Double Wide Open Waterslide. | Sub Total: \$5,000.00 |
| ▪ Paint Exterior of (1) Water Feature with Dumping Bucket. | Sub Total: \$13,500.00 |
| ▪ Total Restoration Project Cost: | Total: \$52,000.00 |

Terms:

- 50% Due upon signing of Terms and Conditions: *(No project is added to work schedule until Deposit is received.)*
- 50% Due upon completion of Project with final walk through with Client.

The Slide Experts would like to thank you in advance for this opportunity. We look forward to working with you on this and any future projects. If you should have any questions or need further information, please do not hesitate to call me at 720-940-0106 or email me at jim@theslideexperts.com

Regards,



Jim Gardiner
Owner/Sales
720-940-0106
www.theslideexperts.com

TERMS AND CONDITIONS

1. **VALIDITY OF OFFER:** Buyer shall indicate acceptance of this Agreement by returning a copy of this Agreement signed by a duly authorized representative of Buyer. If Buyer has not yet indicated acceptance of this Agreement, The Slide Experts offer to perform under the Agreement shall terminate on the earlier of (I) The Slide Experts notification (whether verbal or written) to Buyer that such offer has been terminated, (II) thirty (30) days after the contract date listed on page 1 of this Agreement, or (III) thirty (30) days after Buyer's receipt of this Agreement. The Slide Experts will walk the water park and go over Scope of Work on the first day with Client. Anything out of the ordinary outside the agreed Scope of Work will be negotiated and additional fees may apply at that time.
2. **SCHEDULE OF DELIVERY:** The Slide Experts will use best efforts to provide the Deliverables in accordance with the schedule, but does not guarantee such schedule. Time is not of the essence in this Agreement and The Slide Experts is not liable for any lost profits or consequential damages suffered by Buyer or any third party for any reason. If there is a change in the scope of work or if The Slide Experts falls behind schedule due to the actions of Buyer or any third party, the parties will adjust the schedule to afford The Slide Experts a reasonable opportunity to perform the outstanding work. The Buyer may request adjustments or additions to this project. Upon receipt of the written request for adjustment or additions, The Slide Experts will provide the Buyer with an adjusted proposal. The Slide Experts requires both parties to sign the change order and to update the contract to reflect the change request. No work will occur until the change order is approved in writing by the buyer.
3. **PROJECT REQUIREMENTS:** The Slide Experts assumes responsibility for all statutes, codes, and or regulations that pertain to the Scope of Work, and will perform the work in compliance with all such requirements. The Slide Experts will, if required obtain any and all permits pertaining to the Scope of Work. It is The Slide Experts intention to complete the project on schedule and within budget. Client will have someone in a management position be available for the final walk through and be authorized to sign and approve the final walk through sheet. Unless otherwise specifically noted in the Scope of Work, The Slide Experts is expecting the following services and amenities to be freely available:
 - 1) Restroom facilities.
 - 2) Water with at least 40 lbs. of pressure within 50 feet of project.
 - 3) 110 electric service within 50 feet of project.
 - 4) Clear and reasonable access to the project area.
 - 5.) Pools to be drained and/or generally clean upon arrival of our crew.
 - 6.) It is expected that our crews shall work from 8 am to 8 pm seven (7) days a week as we deem necessary and we expect reasonable cooperation in making the facility available to them at no extra cost to us (e.g. weekend and / or early am work).
 - 7) Provide parking for our vehicles at no charge to The Slide Experts.
4. **TAXES AND/OR DUTIES:** Any tax, tariff or duty imposed by law on articles sold or rented or any services rendered by The Slide Experts, shall be the responsibility of Buyer and in addition to the sales price hereof.
5. **PAYMENT TERMS:** Buyer agrees to pay The Slide Experts the fees in accordance with the terms set forth in this Agreement. The Slide Experts standard terms are 50% of total payment due upon signing of contract and 50% final payment due upon final walk through approved by client. Past due balances will be billed a service charge of 2% per month (or if 2% is illegal under applicable law, the maximum permitted rate) beginning the day after payment is due. Buyer agrees to pay all associated court costs, collection charges and expenses that are incurred by The Slide Experts in collection efforts, including, without limitation, all attorney's fees and expenses, and all costs of repossession and resale. Amounts owed under this Agreement may not be set off or offset by other obligations of the parties for any reason. If Buyer cancels or defaults on this Agreement, Buyer will pay to The Slide Experts the greater of (I) any and all deposits paid to The Slide Experts to be paid by forfeiture of such amounts, and (II) all direct and indirect costs incurred by The Slide Experts in performing under this Agreement, plus a 20% handling fee.
6. **WARRANTY:** The Slide Experts warrants all of its work will be free from defects in material and workmanship under normal use and service with proper maintenance for a period of 12 months from the date of service or installation. Full payment of project has to be meant to start the one year warranty. If The Slide Experts work is found to be defective within this time period, The Slide Experts will provide the labor and materials to repair the defects. Certain products and material warranties are provided by others and will be subject to their respective terms. **THE EXPRESS WARRANTIES CONTAINED IN THIS PARAGRAPH ARE BUYER'S SOLE AND EXCLUSIVE REMEDIES AND ARE IN LIEU OF ANY AND ALL OTHER WARRANTIES, EXPRESS OR IMPLIED, INCLUDING ANY IMPLIED WARRANTY OF MERCHANTABILITY OR FITNESS FOR A PARTICULAR PURPOSE. BUYER ACKNOWLEDGES THAT IT IS NOT RELYING UPON THE SLIDE EXPERTS SKILL AND JUDGMENT TO SELECT OR FURNISH GOODS SUITABLE FOR ANY PARTICULAR PURPOSE AND THAT THERE ARE NO WARRANTIES THAT ARE NOT CONTAINED IN THIS AGREEMENT. THE SLIDE EXPERTS SHALL NOT BE LIABLE FOR DAMAGES, INCLUDING SPECIAL, INCIDENTAL, OR CONSEQUENTIAL DAMAGES, ARISING OUT OF OR IN CONNECTION WITH THE PERFORMANCE OF THESE SERVICES OR THEIR USE BY BUYER. THESE WARRANTIES SHALL NOT APPLY TO PRODUCTS THAT HAVE BEEN USED IN A MANNER OUTSIDE OF THE GUIDELINES SUGGESTED BY THE SLIDE EXPERTS OR THAT HAVE BEEN SUBJECT TO ANY MISUSE OR ABUSE, MISAPPLICATION, REPAIR OR TAMPERING IN ANY WAY AS TO AFFECT PERFORMANCE. THERE IS NO WARRANTY ON CAULKING AND LEAKS.**
7. **INCORPORATION OF SAFETY INFORMATION:** Buyer acknowledges receipt of any and all written safety and operational information from original equipment manufacturer related to the safe use of the equipment including, without limitation, information related to installation, location, maintenance, use, safety surfacing and warning signs verbiage. The Slide Experts will provide Buyer with any and all such safety and operational information regarding the products and services (Deliverables) listed in the Scope of Work. Buyer further acknowledges that it has reviewed all such safety information and hereby indemnifies releases and discharges The Slide Experts from and against any and all liabilities, costs or expenses of injuries or damages to any third party as a result of any use of the equipment and Deliverables that is not in accordance with such safety information.
8. **LIMITATION OF LIABILITY:** Except for the indemnification obligations, neither party is liable to the other for consequential, incidental, direct, indirect or special damages, including commercial loss and lost profits, however caused, in excess of the fees paid under this Agreement.

9. **OWNERSHIP OF INTELLECTUAL PROPERTY:** *The Slide Experts will be the sole owner or obtain any and all permissions of use from such owner, of all intellectual property rights embodied in or related to the scope of work. The Slide Experts will also own or obtain any and all permissions of use for any derivative works, improvements, alterations or modifications conceived by The Slide Experts or any of its employees, consultants or agents. If the scope of work requires The Slide Experts to incorporate a trademark or other intellectual property owned by Buyer or a third party, The Slide Experts will provide a written statement from the Buyer or third party of such intellectual property consenting to its use in the scope of work. Upon the executing of this document, Buyer transfers any and all rights regarding any and all photographic or artistic representations produced by The Slide Experts of the project before, during or after completion of the project for their exclusive use in The Slide Experts sales and marketing efforts or in any other activity The Slide Experts deems appropriate.*
10. **INDEMNIFICATION:** *Buyer will indemnify and hold harmless The Slide Experts, its parent, subsidiaries, affiliates, agents, shareholders, directors, and employees from and against all damages, costs and liabilities (including reasonable attorney's fees and expenses) arising from or related to the actions or inaction of Buyer, its agents and employees and others under its direction or control in conjunction with the operation of the scope of work, the Deliverables and installation.*
11. **CONFIDENTIALITY:** *"Confidential Information" means any and all business, technical or third party information (including without limitation specifications, drawings, sketches, models, samples or documentation) marked as confidential or proprietary (or which a party knows or has reason to know is proprietary) and provided, disclosed, or made available under this Agreement. The parties shall restrict access to the Confidential Information to employees or agents who have a "need to know." The parties, employees, or agents shall not disclose the Confidential Information to any third party and shall treat the Confidential Information in the same way it treats its own Confidential Information of like kind. This provision will not apply to information which is in the public domain, is previously known to the receiving party without obligation of confidentiality, and is independently developed by the receiving party from a third party that does not have an obligation to keep the information confidential.*
12. **NOTICES:** *Notices required under this Agreement shall be sent to the addresses of the parties stated on page 1 of the Sales Agreement. Notices will be deemed given (a) when delivered, if sent by registered or certified mail (return receipt requested), (b) when delivered, if delivered personally.*
13. **GOVERNING LAW; VENUE:** *The laws of the State of Colorado shall govern the construction and interpretation of this Agreement without giving effect to any choice or conflict of law provisions (whether of the State of Colorado or any other jurisdiction) that would cause the application of the laws of any jurisdiction other than the State of Colorado. Buyer hereby consents and submits to the jurisdiction of the state and federal courts located in Colorado for any dispute related to this Agreement. Any lawsuit or litigation initiated by either party and related to this Agreement shall occur in the appropriate state or federal court located in Parker, Colorado and Buyer and The Slide Experts agree that suit shall not be brought in any other jurisdiction or location; provided however, nothing contained in this Section shall prohibit The Slide Experts from pursuing lien claims, bond claims, repossession actions or injunctive relief in any appropriate jurisdiction or court.*
14. **FORCE MAJEURE:** *Neither party is responsible to the other for failure to conform to this Agreement arising from causes beyond its reasonable control, including, but not limited to, labor disputes, unforeseeable delays during shipment, acts of terrorism, floods, civil commotion, war, riot, acts of God, fires, and embargoes.*
15. **WAIVER:** *The failure of Either Party to insist upon strict performance of any of the terms of this Agreement or to exercise any rights conferred in this Agreement, shall not be construed as a waiver or relinquishment of the right to assert or rely upon any such terms or rights at any future occasion.*
16. **ASSIGNMENT:** *The rights and obligations under this Agreement may not be assigned without the prior written consent of the non-assigning Party; provided however, that The Slide Experts may assign its rights and obligations under this Agreement to an affiliate or pursuant to a sale of substantially all of the assets or ownership of The Slide Experts.*
17. **ENTIRE AGREEMENT:** *This Agreement (including the Master Terms and Conditions) is intended to be the final, complete and exclusive expression of the Agreement between the parties. This Sales Agreement supersedes any and all prior written or oral agreements relating to the subject matter hereof. No modification of this Agreement shall be effective except by a written Agreement expressly stating the parties' intent to so modify this Agreement and signed by the parties. No modification of any provision of this Agreement shall be considered a waiver, breach, or cancellation of any other provision of this Agreement. Any provision in the Sales Agreement that is not consistent with the Master Terms and Conditions in this Exhibit A shall be void and not a part of this Sales Agreement.*

APPROVED AND ACCEPTED:

Seller: The Slide Experts, Inc.

Buyer:

Title: Owner

Title:

Print Name: James Gardiner

Print Name:

Signature:

Signature:

Date:

Date:

Safe Slide Restoration

"Restoring Confidence In Your Slide."

Dale Cooper LLC DBA Safe Slide Restoration
P.O. Box 186, Fredericktown, MO 63645
855.639.7543
www.safeslides.com

December 12th, 2018

Town of Surfside, Parks and Recs / Elizabeth Hopkins
9293 Harding Avenue / Surfside, FL 33154
Phone: 305-905-7380 / ehopkins@townofsurfsidefl.gov

Hello Elizabeth,

The following is a proposal for the restoration of your water slides and slide towers. This proposal is based on the inspection Safe Slide Restoration did on November 8, 2018. Our company is certified in fiberglass composites by the American Composite Manufacturer's Association (ACMA). We have over **20-years** of experience working with fiberglass and gel coat.

We Have The Industry's Best Warranties

- There is a **5 - year warranty** on the paint for adhesion.
- There is a **5 - year warranty** on the structural fiberglass repair not to delaminate.
- There is a **5 - year warranty** on the gel coat. With yearly maintenance plan



Unique Restoration System

Products

Superior Products
Industry Proven
Chosen by Performance not Price

Processes

Documented Procedures
Consistent & Standards
Safety Standards
Proper PPE

People

Unmatched Certifications
ACMA, NACE, OSHA, Non-Slip
Experience: 120 Projects Last Year

Guarantees

All Project Managers are ACMA Certified
Gel Coat Thickness Meets OEM Standards
Meeting Deadlines
Responsive

Slide Description:

Open Flume Body Slide – White Interior, Light Green Exterior
Family Body Slide – Turquoise Green
Closed Flume Child Slide - White Interior, Light Green Exterior
Two Slide Structures - Grey

Work Description:

Gel Coat – Interior of Family Body Slide:

- Repair all minor structural repairs in ride path* (minor repair does not require laminating)
- All repairs will be done with vinyl-ester resin
- Prepare interior ride path for Gel Coat
- Lay non-skid at start tub if needed
- Refinish interior ride path of slide with Gel Coat
- Gel Coat will be applied to a thickness of 18 - 24 mils.
- Premium Gel Coat will be used
- Recaulk all seams (recaulking is not a guarantee to stop leaking seams) **
- Seams will be sealed with premium caulk
- Gel coat RAL color: _____ INIT: _____

Structural Repairs - (As Needed On All 3 Slides):

- Repair all structural repairs in ride path*
- All repairs will be done with vinyl-ester resin
- Recaulk seams as needed (recaulking is not a guarantee to stop leaking seams) **
- Seams will be sealed with premium caulk
- Non-slip will be chemically washed, if needed

Polish and Wax – (Interior of Open Flume Body Slide, :

- Clean start tubs and all open flume sections
- Polish start tubs and all open flume sections
- Wax start tubs and all open flume sections

Paint – (Exterior of Open Flume Body Slide, Child Slide and Metal Components of 2 Slide Towers):

- Wash exterior of slide with cleaner
- Prime-coat bare areas as needed
- Paint exterior with Poly - Siloxane Paint
- > Paint RAL color: _____ INIT: _____

Total Project Amount: ...

838 900 06

We at Safe Slide Restoration are committed to quality and customer satisfaction. We are an international company that provides services to the largest water parks and cruise lines in the world. We look forward to putting our expertise to work for you. Please feel free to call our office at 855-639-7543 or my cell at 989-954-6235 if you have any questions or comments.

Thank you for your consideration, we appreciate your time!

Sincerely,
Joshua Lones
Field Safety Inspector
joshua@safeslides.com

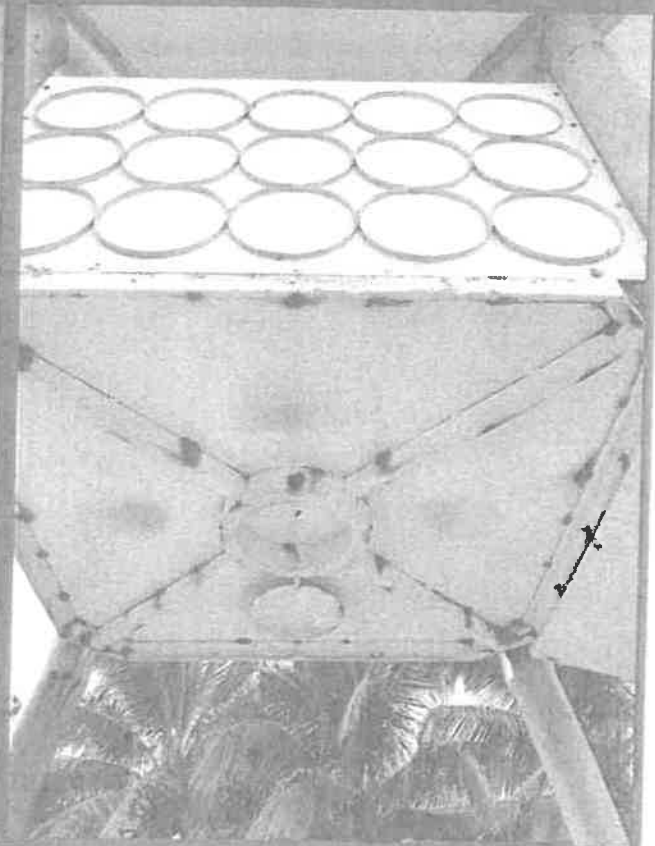
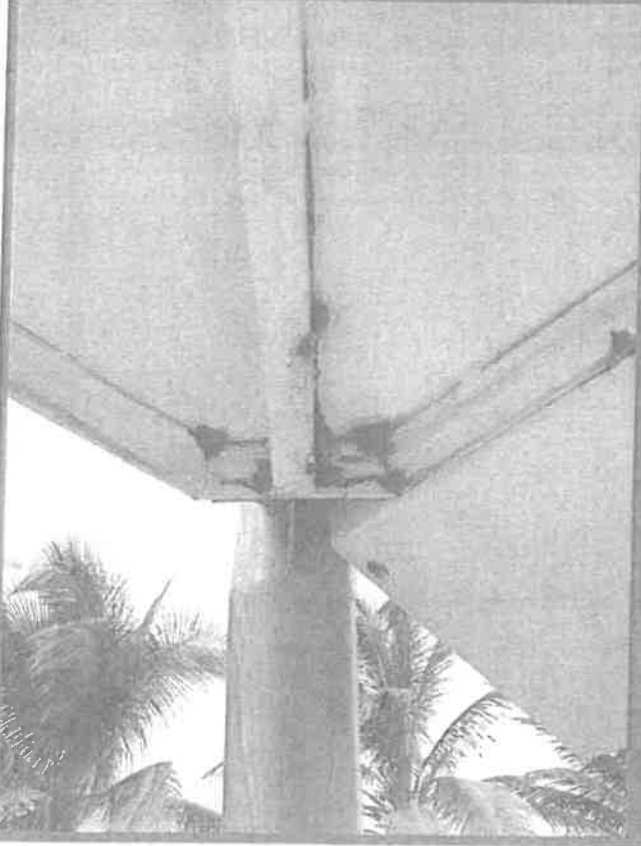
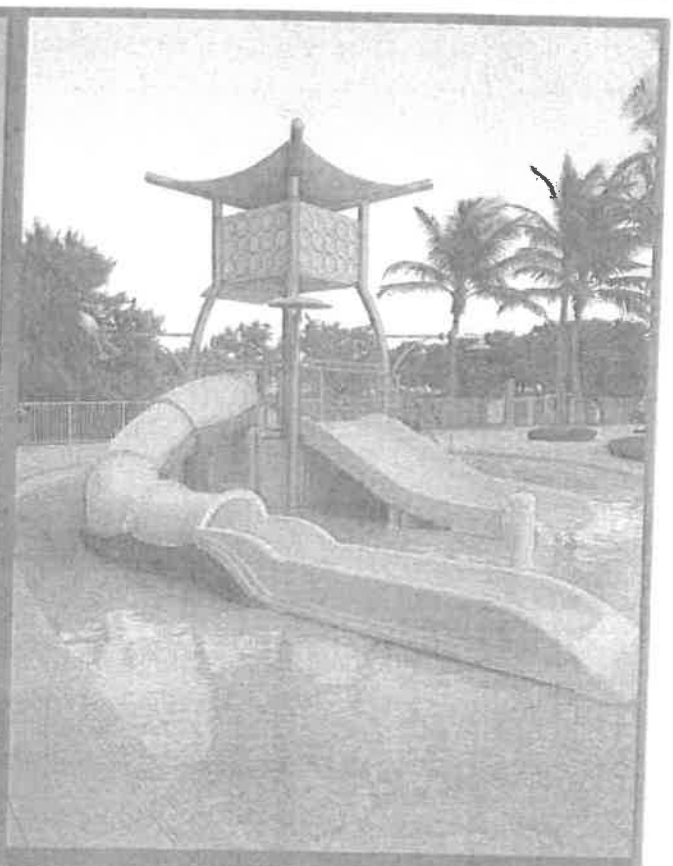
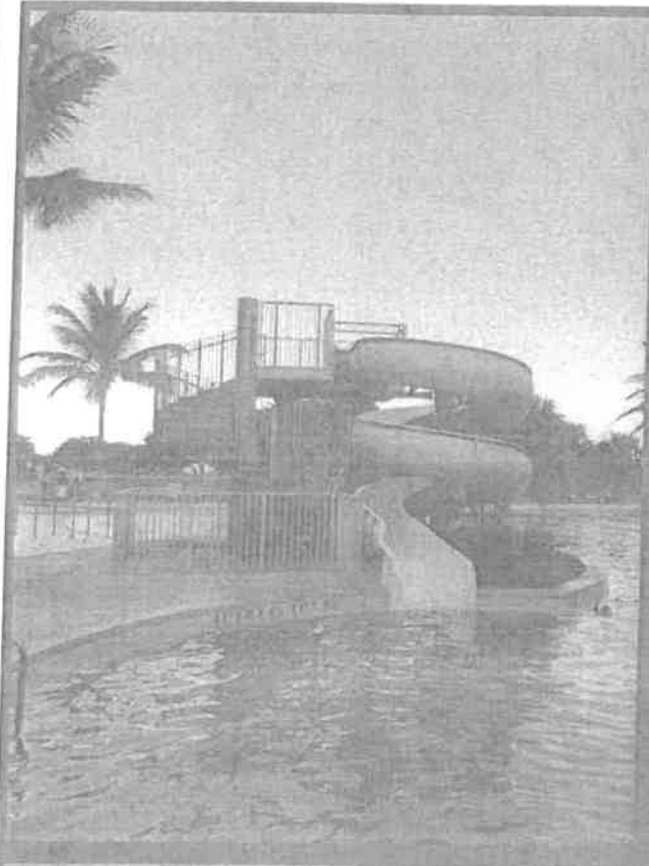

Terms & Conditions

***Structural repair is defined as any damage that is an obvious threat to the guests, (i.e. a chip or gouge with a sharp edge). This is not to be confused with cosmetic repair, (i.e. a spider crack with no flaking or raised edge). This does not include any major repairs that require fiberglass cloth and resin lamination.**

**** Because of the restrictions of our caulk being able to adhere to joints without the proper amount of surface area, we require that the seams are 3/16" wide to caulk them (If the seams to tight the caulk will not adhere).**

Customer Expectations

Safe Slide Restoration reserves the right to have adequate access to the project area to complete the project as efficiently as Safe Slide Restoration deems necessary. This may require, but not limited to: working 12 hours per day / seven days a week. The park is responsible to provide an adequate water source (5 gallons per minute), electrical power (multiple circuits will be needed), and restroom facilities for the duration of the job. If there are any chip repairs and gel coat is required; we are capable of doing in field color-matching for gel coat. Safe Slide technicians will tint the gel coat to match the existing gel coat (This is not to be confused with manufacturer's exact color matching). Customer has the right to request a draw down if request is made 45 days before Safe Slide arrives. Recaulking seams does not apply if the seams are fiberglassed over. If legal proceedings are necessary, they will have to be carried out in Madison County, Missouri.

Customer Responsibilities

If we are repairing leaking seams the customer is responsible for identifying the leaking seams by labeling seams on the interior and exterior of slide (we recommend using a permanent marker in the ride path to label seams). Customer is responsible for identifying areas where lift cannot operate. If a lift is needed, we are not responsible for any broken concrete, landscaping, etc. Safe Slide may request the removal of fencing to allow a lift to access the water slide area (if there isn't access through gate opening). Customer is responsible for providing waste removal. The customer is required to provide access to restrooms for entirety of project. A walk through of finished work as well as a sign-off is required before our staff leaves the job site. Missing the post project walk through is equivalent to an approved sign off by the customer. Safe Slide Restoration will not be responsible for unscheduled return work in the case that the customer misses scheduled post project walk-through and subsequent sign-off.

Possible Additional Charges/Non-Warranty Items

We do not warranty wet coring or wet substrates. There will be an additional charge for interior or exterior failed coatings. If there are any previous interior or exterior coatings; Safe Slide Restoration does not warranty any substrates previously coated after the manufacturer's original coating, or any previous repairs. The pricing above does not include the cost of state taxes, licenses, or permits if required. Sometimes slides require a second coat of paint to achieve the desired finish. If a second coat of paint is required there will be an additional charge of 50% of the original paint price. A 2-3-point Tie-off system on top portion of closed flume slide may be needed if a lift is inaccessible. A cost of \$90 per panel will be assessed and tie offs will stay in place for customer use. An additional daily fee may be assessed if the project site is compromised due to negligence of customer or persons under the customer's control of on said project site. If the customer does not show up and needs to postpone the post job walk through, there will be an additional charge for the delay. This will be determined by how long Safe Slide must stay on site in order to get the walk-through and sign-off which is required before our staff leaves the site. **The cost of a lift is not included in the above pricing.** If a lift is required, it will be the responsibility of the park to provide.

Confidentiality Agreement

The information in this document is confidential to the person to whom it is addressed and should not be disclosed to any other person. It may not be reproduced in whole, or in part, nor may any of the information contained therein be disclosed without the prior written consent of the directors of Safe Slide Restoration.

RESOLUTION NO. 2020 ____

A RESOLUTION OF THE TOWN COMMISSION OF THE TOWN OF SURFSIDE, FLORIDA, APPROVING THE PURCHASE OF WATERSLIDE REPAIR AND MAINTENANCE WORK FROM DALE COOPER LLC D/B/A SAFE SLIDES RESTORATION; FINDING THAT THE PURCHASE IS EXEMPT FROM COMPETITIVE BIDDING PURSUANT TO SECTION 3-13(7)F OF THE TOWN CODE AS A PUBLIC WORKS OR UTILITIES PURCHASE FOR TOWN FACILITY MAINTENANCE WORK; AUTHORIZING THE TOWN MANAGER TO ENTER INTO A PURCHASE ORDER FOR SUCH PURCHASE; PROVIDING FOR IMPLEMENTATION; AND PROVIDING FOR AN EFFECTIVE DATE.

WHEREAS, the Town of Surfside (Town”) needs repair and maintenance work for the waterslides located at the Town Community Center’s main pool and Sand Dollar Key Water Tot Lot (“Work”); and

WHEREAS, pursuant to Section 3-13(7)(f) of the Town’s Code, public works or utilities maintenance and repair purchases for Town facilities are exempt from competitive bidding; and

WHEREAS, the Town solicited three (3) quotes for the Work and received the lowest quote from Dale Cooper LLC d/b/a Safe Slides Restoration (“Vendor”);

WHEREAS, the Vendor has provided a quote attached hereto as Exhibit “A” for the Work at a cost of \$38,900.00 (the “Quotation”); and

WHEREAS, the Town Commission wishes to authorize the Town Manager to purchase the Work and enter into a Purchase Order with the Vendor, in substantially the same form as the Quotation attached hereto as Exhibit “A”; and

WHEREAS, the Town Commission finds that the purchase of the Work is in the best interests and welfare of the Town.

NOW, THEREFORE, BE IT RESOLVED BY THE TOWN COMMISSION OF THE TOWN OF SURFSIDE, FLORIDA, AS FOLLOWS:

Section 1. Recitals Adopted. Each of the above stated recitals are hereby adopted, confirmed, and incorporated herein.

Section 1. Purchase of Work Approved; Exemption from Competitive Bidding.
The purchase of the Work in the amount of \$38,900.00 from the Vendor is hereby approved. The Town Commission finds that pursuant to Section 3-13(7)(f) of the Town’s Code, the purchase of the Work is exempt from competitive bidding. The Quotation, in substantially the same form attached hereto as Exhibit “A,” is hereby approved, and the Town Manager is authorized to execute a Purchase Order for the Work in substantially the same form as the Quotation attached hereto as Exhibit “A.”

Section 3. Implementation. The Town Manager and Town Officials are authorized to take any and all necessary or further action to implement the purchase of the Work and the purposes of this Resolution.

Section 4. Effective Date. This Resolution shall be effective immediately upon adoption.

PASSED AND ADOPTED this 23rd day of June, 2020.

FINAL VOTE ON ADOPTION:

Commissioner Charles Kesl _____
Commissioner Eliana R. Salzhauer _____
Commissioner Nelly Velasquez _____
Vice Mayor Tina Paul _____
Mayor Charles W. Burkett _____

Charles W. Burkett, Mayor

ATTEST:

Sandra Novoa, MMC
Town Clerk

**APPROVED AS TO FORM AND LEGALITY FOR THE USE
AND BENEFIT OF THE TOWN OF SURFSIDE ONLY:**

Weiss Serota Helfman Cole & Bierman, P.L.
Town Attorney

Exhibit “A”



TOWN OF SURFSIDE
 9293 Harding Avenue
 Surfside, FL 33154
 PH: (305) 861-4863
 website: www.townofsurfsidefl.gov

PURCHASE ORDER

PO Number: POFY200TBD **Date:** 10/30/2019
Requisition #: REQ00TBD **Vendor #:** 1410

ISSUED TO:

SHIP TO: TOWN OF SURFSIDE
 9293 HARDING AVE
 SURFSIDE, FL 33154

ITEM	UNITS	DESCRIPTION	GL ACCT #	PROJ ACCT #	PRICE	AMOUNT
1						
2						
3						

SUBTOTAL:	
SHIPPING:	0.00
Total:	

Authorized by: _____

GENERAL TERMS AND CONDITIONS

The following General Terms and Conditions shall apply to all purchases by or on behalf of the Town of Surfside ("the Town") Pursuant to Chapter 212, Florida Statutes, the Town is Exempt from State of Florida Sales Tax by virtue of Exemption Certificate No. 59-6000434 Florida Retailers' Occupation Tax, Use Tax and Municipal Retailer's Occupation Tax do not apply to materials purchased by the Town. Vendors must not charge for any of these taxes. The Town reserves the right to cancel this P.O. at any time, should the Vendor not comply with any of the Terms and Conditions herein.

- Acceptance of Contract:** This purchase order ("P.O.") is the Town's offer to purchase the goods and/or services from Vendor pursuant to the terms and conditions set forth herein. Upon acceptance of this P.O., by delivery of goods or performance of the services, this P.O. shall become a contract and subsequently binding upon Vendor. Any separately executed contract between the Town and a Vendor supersedes the terms and conditions of this P.O.
- Amendments:** No agreement or understanding to modify this P.O. shall be binding upon the Town unless in writing and signed by the Town's authorized agent. All specifications, drawings, data or any other related documentation submitted to the Vendor with this P.O. are hereby incorporated and made a part hereof.
- Uniform Commercial Code:** All applicable portions of the State of Florida Uniform Commercial Code shall govern contracts with The Town.
- Non-Waiver of Rights:** No failure of either party to exercise any power given to it hereunder, or to insist upon strict compliance by the other party with its obligations hereunder, and no custom or practice of the parties at variance with the terms hereof, nor any payment under this agreement shall constitute a waiver of either party's right to demand exact compliance with the terms hereof.
- Compliance with Laws:** Vendor certifies that in performing this contract they will comply with all applicable provisions of federal, state and local laws, regulations, rules and orders, including the Town of Surfside Charter and Code of Ordinances.
- Laws Governing:** This contract shall be governed by and construed according to the laws of the State of Florida. Venue for any action related to this agreement shall be in Miami-Dade County, Florida.
- Payment:** Method of Compensation: net 45 days and in accordance with the Florida Prompt Payment Act. All invoices are to be addressed to the "Bill To" designee, as indicated on the front of this P.O., and must include the P.O. number, vendor's name and phone number, clearly list quantities, item descriptions and units of measure, (if applicable). Failure to do so may result in payment delays at no cost to the Town.
- Warranty:** Vendor warrants to the Town that all goods and services furnished hereunder will conform in all respects to the terms of this order, including any specifications or standards incorporated herein, and/or defects in materials, workmanship, and free from such defects in design. In addition, Vendor warrants the goods and services are suitable for and will perform in accordance with the purposes for which they were intended
- Indemnity:** Vendor shall defend, indemnify and hold harmless the Town, its officers, agents, employees and successors, from and against any and all claims, liabilities, damages, demands, losses, causes of action and suits, including reasonable attorneys' fees incident thereto, to the extent they result directly from or out of any injury to or death of any person or damage to or destruction of any property caused by the negligent acts, errors, omissions or willful misconduct of Vendor, its agents or employees.
- Compliance with Public Records Law:** Vendor shall comply with any and all requirements of Chapter 119, Florida Statutes, Florida's Public Records Act. Vendor is required to comply with Florida's public records law and specifically to: Keep and maintain public records required by the Town; Upon request from the Town, provide the Town with a copy of the requested records or allow the records to be inspected or copied within a reasonable time at a cost that does not exceed the cost provided in Chapter 119, Florida Statutes, or as otherwise provided by law; Ensure that public records that are exempt or confidential and exempt from public records disclosure requirements are not disclosed except as authorized by law; and Upon completion of the services or agreement, transfer, at no cost, to the Town, all public records in possession of Vendor or keep and maintain public records required by the Town to perform the services. If Vendor transfers all public records to the Town upon completion of the services or this agreement, Vendor shall destroy any duplicate public records that are exempt or confidential and exempt from public records disclosure requirements.
- Insurance.** Vendor shall provide applicable insurance, as required by the Town prior to the purchase or services provided
- Delivery:** All prices must be Freight on Board ("F.O.B.") destination, freight prepaid. Vendor shall meet any established delivery date. If delivery dates cannot be met as agreed, the Vendor agrees to advise the Town, in writing, and seek written approval, of the earliest possible delivery date for acceptance by the Town. Regardless of F.O.B. point, Vendor agrees to bear all risk of loss, injury or destruction of goods and materials ordered herein, which may for any reason occur prior to acceptance by the Town. No such loss, injury or destruction shall release Vendor from any obligations hereunder. Goods and/or materials must be properly packaged. Damaged goods and materials will not be accepted. Or, if the damage is not readily apparent at the time of delivery, the goods shall be returned at no cost to the Town. The Town receives the right to inspect the goods within a reasonable time subsequent to delivery where circumstances or conditions prevent effective inspection of the goods at the time of delivery.
- Non-Discrimination:** Vendor shall comply with all applicable state and federal civil rights laws.



MEMORANDUM

ITEM NO. 2C

To: Honorable Mayor, Vice-Mayor and Members of the Town Commission

From: Guillermo Olmedillo, Town Manager

Date: June 9, 2020

Subject: Youth Sports Program Coaches (Cyclone Soccer)

The Town of Surfside, Parks and Recreation Department, has previously arranged each year for the professional coaching and instruction for Youth Sports Program participants with contractual sports coaching services. Over the past 13 years Cyclone Soccer has provided high quality Soccer Coaching for the Town's Parks and Recreation Youth Sports Soccer Programs. Cyclone Soccer holds Certifications and License from United States Soccer Federation, United States Amateur Soccer Association.

Youth Soccer programs run annually for 3 seasons, Fall, Winter and Spring. Each Soccer Season runs 4 days a week for 10 weeks and competitive games are played off site on weekends. The professional coaching and instruction provided by Cyclone Soccer over the years has contributed to the long-time successful operations of the Youth Sports Programs. The Youth Soccer Program is always at maximum enrollment capacity during the course of the year.

Youth Soccer is budgeted under Parks and Recreation (Other Contractual Service) for the full amount to operate the programs annually. Total Annual cost is Budgeted at \$33,500 Annual estimated revenue is \$35,000.

The Town of Surfside, Parks and Recreation Department, has utilized Cyclone Soccer from the start of the Youth Soccer Program back in 2006. The stability, and professional coaching and instruction has contributed to the efficiency, popularity and overall long-term success of the program. The cost associated with the professional coaching is consistent with other outside organizations. Therefore, recommending to waive the competitive bidding process.

Staff request a motion to approve expenditures for the year, waving the procurement for Youth Soccer. Authorizing for the approval of the expenditures for the 2019-2020 Youth Sports Program (Soccer) Coaches and Instructors \$33,500.

Reviewed by TM

Prepared by TM

RESOLUTION NO. 2020-_____

A RESOLUTION OF THE TOWN COMMISSION OF THE TOWN OF SURFSIDE, FLORIDA, APPROVING AGREEMENTS WITH CYCLONE SOCCER MIAMI, INC. FOR THE TOWN'S YOUTH INSTRUCTIONAL SOCCER AND COMPETITIVE SOCCER PROGRAMS; FINDING THAT THE SERVICES ARE EXEMPT FROM COMPETITIVE PROCUREMENT PURSUANT TO SECTION 3-13(2) OF THE TOWN CODE; PROVIDING FOR IMPLEMENTATION; AND PROVIDING FOR AN EFFECTIVE DATE.

WHEREAS, the Town of Surfside (the "Town") Parks and Recreation Department has historically contracted with coaches and instructors for the Town's sports programs; and

WHEREAS, Cyclone Soccer Miami, Inc. ("Cyclone") has agreed to conduct the Town's youth instructional soccer and competitive soccer programs (the "Soccer Programs") pursuant to the contractual services agreements attached hereto as Exhibits "A" and "B," respectively (collectively, the "Soccer Agreements"); and

WHEREAS, Section 3-13(2) of the Town Code of Ordinances (the "Code") provides that contracts for professional services are exempt from the competitive bidding procedures of Chapter 3 of the Town Code; and

WHEREAS, the Town Commission finds that the Soccer Programs provided by Cyclone are exempt from competitive bidding pursuant to Section 3-13(2) of the Town Code and wishes to approve the Soccer Agreements with Cyclone in substantially the same forms attached hereto as Exhibits "A" and "B"; and

WHEREAS, the Town Commission finds that this Resolution is in the best interest and welfare of the residents of the Town.

NOW, THEREFORE, BE IT RESOLVED BY THE TOWN COMMISSION OF THE TOWN OF SURFSIDE, FLORIDA, AS FOLLOWS:

Section 1. Recitals. That each of the above-stated recitals are hereby adopted, confirmed, and incorporated herein.

Section 2. Approval of Soccer Agreements. That the Town Commission hereby approves the Soccer Agreements with Cyclone, in substantially the same forms attached hereto as Exhibits “A” and “B.”

Section 3. Implementation. The Town Commission hereby authorizes the Town Manager to execute the Soccer Agreements with Cyclone, together with such non-substantive changes as may be approved by the Town Manager, subject to approval by the Town Attorney as to form and legality, and to take any action which is reasonably necessary to implement the purposes of this Resolution.

Section 4. Authorization to Expend Funds. The Town Manager is authorized to expend funds in accordance with the Soccer Agreements, attached hereto as Exhibits “A” and “B.”

Section 5. Effective Date. This Resolution shall become effective immediately upon adoption.

PASSED AND ADOPTED this 23rd day of June, 2020.

Motion By: _____

Second By: _____

FINAL VOTE ON ADOPTION:

Commissioner Charles Kesl _____

Commissioner Eliana R. Salzhauer _____

Commissioner Nelly Velasquez _____

Vice Mayor Tina Paul _____

Mayor Charles W. Burkett _____

Charles W. Burkett, Mayor

ATTEST:

Sandra Novoa, MMC
Town Clerk

**APPROVED AS TO FORM AND LEGALITY FOR THE USE
AND BENEFIT OF THE TOWN OF SURFSIDE ONLY:**

Weiss Serota Helfman Cole & Bierman, P.L.
Town Attorney

**TOWN OF SURFSIDE
CONTRACTUAL SERVICES AGREEMENT
FOR YOUTH INSTRUCTIONAL SOCCER PROGRAM**

This Independent Contractor Agreement ("Agreement") is entered into and made effective as of April 1, 2020 between the Town of Surfside, Florida, a Florida municipal corporation (the "Town") and Cyclone Soccer Miami, Inc. ("Contractor"), S.S. # N/A, whose address is: 1001 91st Street #607 Bay Harbor, FL 33154.

WITNESSETH:

WHEREAS, the Town desires to obtain specialized services or instruction for the public; and

WHEREAS, the Town Manager is authorized to secure such services from a qualified independent contractor; and

WHEREAS, the Town finds that Contractor possesses the necessary qualifications and ability to provide the services or instruction required by the Town.

NOW THEREFORE, in consideration of the mutual covenants, promises and conditions contained herein, and other good and valuable consideration, the parties hereto do covenant and agree as follows:

1. Services:

The Town hereby retains the services of Contractor to provide services as set forth below. The Contractor shall obtain all required memberships and/or certifications for such services and shall be required to provide proof prior to execution of this Agreement. Any employees, agents, subcontractors, or representative of the Contractor who will be asked to provide services to the Town on the Contractor's behalf must provide proof of applicable certification/registration by the appropriate agency or affiliation and is subject to approval by the Town Manager.

Contractor shall perform the following services at the request of the Town Manager or his or her designee; **Fitness**

Such services require the following memberships and/or certifications;

Fitness Certification

Contractor and any employees, agents, subcontractors, or representatives of Contractor must meet all requirements as set forth herein including, and not limited to, successful completion of a background check which may include, (if applicable for services to be provided,) criminal background check, drug screening, credit check, reference check, past employment verification and proof of education; and written approval by the Town Manager or his designee prior to beginning work with the Town.

2. TERM:

The Term of this Agreement shall commence upon the 1st day of April, 2020 shall continue through September 30, 2020 unless sooner cancelled. The Town may renew this Agreement by giving Contractor thirty (30) days written notice prior to the expiration of the term.

3. FEE/HOURS OF SERVICE:

Contractor shall receive no other (than listed below) compensation or benefits from the Town. Contractor shall pay all of its own expenses incurred in performing the contract services except that the Town shall reimburse Contractor for expenses pre-approved in writing by the Town Manager.

Town shall pay an hourly base fee of \$80.00/Head Coach per class, \$30.00/ First Assistant Coach per class and \$20.00/Second Assistant Coach per class to Contractor for Contractor's services as provided hereinabove. Contractor shall submit an invoice twice monthly to the appropriate Department as determined by the service provided. Contractor shall be responsible for the payment of all taxes and withholdings in connection with earnings. Town will report fees earned by Contractor to the Internal Revenue Service on IRS Form 1099.

4. TERMINATION:

Either party may termination this Agreement without cause upon seven (7) days written notice to the other party.

The following shall constitute default by Contractor and give the Town the right to terminate this Agreement for cause:

- A. Poor attendance, which shall mean two (2) or more unexcused absences; or
- B. Failing to perform the services required under this Agreement or failing to timely begin classes and other services herein.

Upon default by Contractor, the Town may terminate this Agreement immediately by providing written notice of such default. Contractor shall be paid for those services actually performed and approved by the Town Manager, or his designee, up to the time of termination.

5. INDEPENDENT CONTRACTOR STATUS:

It is expressly intended, understood and agreed that Contractor is acting solely as an independent contractor and in no respect an agent, servant, or employee of the Town. Accordingly, Contractor shall not attain or be entitled to any rights or benefits of the Town, nor any rights generally afforded classified or unclassified employees. Contractor's employees shall not be deemed an employee of, the Town. Contractor shall be responsible for the payment of all taxes and withholdings in connection with earnings. Town will report fees earned by Contractor to the Internal Revenue Service on IRS Form 1099.

Contractor shall be solely responsible for any injuries suffered by Contractor's employees. It is clear that Town will not provide workers' compensation insurance for Contractor or its employees.

Nothing contained in the Agreement shall be construed so as to create a partnership or joint venture and neither party hereto shall be liable for the debts or obligations of the others. No employee or agent of Contractor shall be deemed to be an employee or agent of Town. Contractor shall be responsible for compliance with all applicable, local, state and federal laws and regulations in the performance of any services to the Town. Should any question arise as to the interpretation or as to the nature of the services to be provided by Contractor the opinion of the Contractor shall establish for all purposes the nature of the work. Contractor shall have no power to obligate Town in any manner whatsoever. Town shall not be liable for any acts of the Contractor in the performance of this Agreement.

6. RECORDS:

Contractor further agrees that all records, books, documents, papers and financial information ("Records") that result from Contractor providing services to Town under this agreement shall be the property of the Town. Upon termination or cancellation of this agreement, any and all such Records shall be delivered to the Town by Contractor within ten (10) days. Contractor shall maintain records, books, documents, papers and financial information pertaining to work performed under this agreement during the term of this agreement and for a period of three (3) years following termination of this agreement. The Town Manager or his designee shall have access to and the right to examine and audit any Records involving Contractor's services related to this agreement. The restrictions and obligations of this section of the Agreement shall survive any expiration, termination, or cancellation of this Agreement and shall continue to bind the Contractor, his heirs, successors and assigns.

7. INSURANCE/INDEMNIFICATION:

Contractor shall carry General Liability insurance of at least \$ 1,000,000 per occurrence. The Town shall be named as an additional insured on any such insurance policy and the policy shall state that it is not subject to cancellation or reduction in coverage without written notice to the Town at least 30 days prior to the effective date of cancellation or reduction in coverage. Contractor shall provide Town with a copy of the policy prior to the commencement of any instructional services by either Contractor or instructors hired by Contractor.

Contractor agrees to indemnify, defend and hold Town and its officers, directors, officials, employees and agents harmless from and against all fines, penalties, costs and expenses (including but not limited to attorneys fees), suits, actions, damages, judgments, claims, demands, liabilities, losses and causes of action which may be asserted against or suffered or incurred by Town arising out of incident to or in connection with the furnishing of the contract services by Contractor or any activities by Contractor under this agreement or otherwise based upon the negligence, intentional tort, omissions of, or the breach of this agreement by Contractor.

The provisions of this section shall survive termination of this Agreement.

8. COUNTERPARTS:

This Agreement may be executed in two or more counterparts, each of which shall be deemed an original, but all of which shall constitute the same agreement. A facsimile signature on a counterpart shall be acceptable and binding.

9. ASSIGNMENT:

The services of Contractor are personal in nature. Accordingly, Contractor shall not assign his/her rights to this Agreement without the prior written consent of the Town Manager. Contractor may assign this Agreement to a corporation wholly owned by the Contractor, or to any entity in which the Contractor is a majority share holder.

10. BACKGROUND CHECK:

Contractor agrees that based upon the type of services to be provided, the Agreement is conditioned upon successful completion of a criminal background check, including any or all of the following; drug screening, credit check, reference check, past employment verification, and proof of education.

Contractor shall be responsible for maintaining current background checks on all employees involved in the performance of the Agreement. Background checks must be performed prior to the performance of any work by the employee under this Agreement. Written verification of all background checks must be provided to the Town Manager prior to the performance of any work by the employee under this Agreement. Contractor acknowledges that in the performance of the services contemplated in this Agreement, Contractor's employees may have contact with children. Accordingly, no employees shall be assigned to work for the Town under this Agreement whose background check reveals behavior which would prohibit such contact. Documentation of required certification and insurance must be provided to the Town prior to commencement of any instructional services by either Contractor or instructors hired by the Contractor.

11. PUBLIC RECORDS:

Contractor shall comply with the applicable provisions of Chapter 119, Florida Statutes. The Town shall have the right to immediately terminate this Agreement for the refusal by Contractor to comply with Chapter 119, Florida Statutes. Contractor shall retain all records associated with this Agreement for a period of three (3) years from the date of termination or expiration.

During the term of this Agreement and for three (3) years from the date of termination or expiration, Contractor shall allow Town representatives access during reasonable business hours to Contractor's records related to this Agreement for the purposes of inspection or audit of such records. If upon audit of such records, the Town determines Contractor was paid for services not performed, upon receipt of written demand by the Town, Contractor shall remit such payment to the Town.

12. NOTICES:

All notices and communications to the Town or Contractor shall be in writing and shall be deemed to have been properly given if transmitted by registered or certified mail or hand delivery or private delivery service. All notices and communications shall be effective upon receipt. Notices shall be addressed as follows:

Town: Town of Surfside, Florida
9293 Harding Avenue
Surfside, Florida 33154
ATTN: Town Manager
Telephone: (305) 861-4863
Facsimile: (305) 861-1302

Contractor: Eduardo Gabriel Alves
Cyclone Soccer Miami, Inc.
1001 91st Street #607
Bay Harbor, FL 33154

13. MISCELLANEOUS:

This Agreement constitutes the entire agreement of the parties with respect to the subject matter hereof and supersedes all prior agreements, written or oral, between the parties to this Agreement. This Agreement shall be binding upon and inure to the benefit of, and be enforceable by, the parties and their respective legal representatives, successors and assigns. Contractor may not assign its rights or obligations hereunder without the prior written consent to Town. No waiver by the parties of any default or breach of any term, condition, or covenant of this Agreement shall be deemed to be a waiver of any other breach of the same or any other term, condition or covenant contained herein. This Agreement shall be deemed to have been mutually drafted by the parties. Therefore, neither this Agreement nor any section hereof or amendment hereto shall be construed against any party due to the fact that the Agreement or any section hereof or amendment hereto may have been primarily drafted by said party. If any provision of this Agreement, or the applications of such provision to any person or circumstance, shall be held invalid the remainder of this Agreement or the application of such provision to persons or circumstances other than those as to which it is held invalid, shall not be affected thereby. Should any litigation be commenced between the parties thereto, the party prevailing in such litigation shall be entitled, in addition to such other relief as may be granted, to its costs and a reasonable sum for attorney's fees in such litigation and any appeal thereof or in bankruptcy proceedings. Venue in any litigation shall lie exclusively in Miami-Dade County, Florida. THE PARTIES HERETO WAIVE ALL RIGHT TO TRIAL BY JURY IN ANY ACTION, SUIT, OR PROCEEDING BROUGHT TO RESOLVE ANY DISPUTE, WHETHER IN CONTRACT, TORT OR OTHERWISE ARISING OUT OF, CONNECTED WITH, RELATED TO, OR INCIDENTAL TO THIS AGREEMENT.

IN WITNESS WHEREOF, the undersigned parties have executed this Agreement on the 1st day of April, 2020

**TOWN OF SURFSIDE,
a Florida municipal corporation:**

Town Manager

ATTEST:

Town Clerk

APPROVED AS TO FORM AND LEGALITY
FOR THE USE AND BENEFIT OF
TOWN OF SURFSIDE ONLY:

Town Attorney

CONTRACTOR:

By: 
(Signature)
EDUARDO GABRIEL ALVES
(Print Name)

1001 91 ST STREET APT 607
(Address)
BAY HARBOR ISLANDS FL 33154

**TOWN OF SURFSIDE
CONTRACTUAL SERVICES AGREEMENT
FOR COMPETITIVE SOCCER PROGRAM**

This Independent Contractor Agreement ("Agreement") is entered into and made effective as of April 1, 2020 between the Town of Surfside, Florida, a Florida municipal corporation (the "Town") and Cyclone Soccer Miami, Inc. ("Contractor"), S.S. # N/A, whose address is: 1001 91st Street #607 Bay Harbor, FL 33154

WITNESSETH:

WHEREAS, the Town desires to obtain specialized services or instruction for the public; and

WHEREAS, the Town Manager is authorized to secure such services from a qualified independent contractor; and

WHEREAS, the Town finds that Contractor possesses the necessary qualifications and ability to provide the services or instruction required by the Town.

NOW THEREFORE, in consideration of the mutual covenants, promises and conditions contained herein, and other good and valuable consideration, the parties hereto do covenant and agree as follows:

1. Services:

The Town hereby retains the services of Contractor to provide services as set forth below. The Contractor shall obtain all required memberships and/or certifications for such services and shall be required to provide proof prior to execution of this Agreement. Any employees, agents, subcontractors, or representative of the Contractor who will be asked to provide services to the Town on the Contractor's behalf must provide proof of applicable certification/registration by the appropriate agency or affiliation and is subject to approval by the Town Manager.

Contractor shall perform the following services at the request of the Town Manager or his or her designee; **Fitness**

Such services require the following memberships and/or certifications;

Fitness Certification

Contractor and any employees, agents, subcontractors, or representatives of Contractor must meet all requirements as set forth herein including, and not limited to, successful completion of a background check which may include, (if applicable for services to be provided,) criminal background check, drug screening, credit check, reference check, past employment verification and proof of education; and written approval by the Town Manager or his designee prior to beginning work with the Town.

2. TERM:

The Term of this Agreement shall commence upon the 1st day of April, 2020 shall continue through September 30, 2020 unless sooner cancelled. The Town may renew this Agreement by giving Contractor thirty (30) days written notice prior to the expiration of the term.

3. FEE/HOURS OF SERVICE:

Contractor shall receive no other (than listed below) compensation or benefits from the Town. Contractor shall pay all of its own expenses incurred in performing the contract services except that the Town shall reimburse Contractor for expenses pre-approved in writing by the Town Manager.

Town shall pay an hourly base fee \$80.00/Head Coach per class, \$30.00/ First Assistant Coach per class and \$20.00/Second Assistant Coach per class to Contractor for Contractor's services as provided hereinabove. Contractor shall submit an invoice twice monthly to the appropriate Department as determined by the service provided. Contractor shall be responsible for the payment of all taxes and withholdings in connection with earnings. Town will report fees earned by Contractor to the Internal Revenue Service on IRS Form 1099.

4. TERMINATION:

Either party may termination this Agreement without cause upon seven (7) days written notice to the other party.

The following shall constitute default by Contractor and give the Town the right to terminate this Agreement for cause:

- A. Poor attendance, which shall mean two (2) or more unexcused absences; or
- B. Failing to perform the services required under this Agreement or failing to timely begin classes and other services herein.

Upon default by Contractor, the Town may terminate this Agreement immediately by providing written notice of such default. Contractor shall be paid for those services actually performed and approved by the Town Manager, or his designee, up to the time of termination.

5. INDEPENDENT CONTRACTOR STATUS:

It is expressly intended, understood and agreed that Contractor is acting solely as an independent contractor and in no respect an agent, servant, or employee of the Town. Accordingly, Contractor shall not attain or be entitled to any rights or benefits of the Town, nor any rights generally afforded classified or unclassified employees. Contractor's employees shall not be deemed an employee of, the Town. Contractor shall be responsible for the payment of all taxes and withholdings in connection with earnings. Town will report fees earned by Contractor to the Internal Revenue Service on IRS Form 1099.

Contractor shall be solely responsible for any injuries suffered by Contractor's employees. It is clear that Town will not provide workers' compensation insurance for Contractor or its employees.

Nothing contained in the Agreement shall be construed so as to create a partnership or joint venture and neither party hereto shall be liable for the debts or obligations of the others. No employee or agent of Contractor shall be deemed to be an employee or agent of Town. Contractor shall be responsible for compliance with all applicable, local, state and federal laws and regulations in the performance of any services to the Town. Should any question arise as to the interpretation or as to the nature of the services to be provided by Contractor the opinion of the Contractor shall establish for all purposes the nature of the work. Contractor shall have no power to obligate Town in any manner whatsoever. Town shall not be liable for any acts of the Contractor in the performance of this Agreement.

6. RECORDS:

Contractor further agrees that all records, books, documents, papers and financial information ("Records") that result from Contractor providing services to Town under this agreement shall be the property of the Town. Upon termination or cancellation of this agreement, any and all such Records shall be delivered to the Town by Contractor within ten (10) days. Contractor shall maintain records, books, documents, papers and financial information pertaining to work performed under this agreement during the term of this agreement and for a period of three (3) years following termination of this agreement. The Town Manager or his designee shall have access to and the right to examine and audit any Records involving Contractor's services related to this agreement. The restrictions and obligations of this section of the Agreement shall survive any expiration, termination, or cancellation of this Agreement and shall continue to bind the Contractor, his heirs, successors and assigns.

7. INSURANCE/INDEMNIFICATION:

Contractor shall carry General Liability insurance of at least \$ 1,000,000 per occurrence. The Town shall be named as an additional insured on any such insurance policy and the policy shall state that it is not subject to cancellation or reduction in coverage without written notice to the Town at least 30 days prior to the effective date of cancellation or reduction in coverage. Contractor shall provide Town with a copy of the policy prior to the commencement of any instructional services by either Contractor or instructors hired by Contractor.

Contractor agrees to indemnify, defend and hold Town and its officers, directors, officials, employees and agents harmless from and against all fines, penalties, costs and expenses (including but not limited to attorneys fees), suits, actions, damages, judgments, claims, demands, liabilities, losses and causes of action which may be asserted against or suffered or incurred by Town arising out of incident to or in connection with the furnishing of the contract services by Contractor or any activities by Contractor under this agreement or otherwise based upon the negligence, intentional tort, omissions of, or the breach of this agreement by Contractor.

The provisions of this section shall survive termination of this Agreement.

8. COUNTERPARTS:

This Agreement may be executed in two or more counterparts, each of which shall be deemed an original, but all of which shall constitute the same agreement. A facsimile signature on a counterpart shall be acceptable and binding.

9. ASSIGNMENT:

The services of Contractor are personal in nature. Accordingly, Contractor shall not assign his/her rights to this Agreement without the prior written consent of the Town Manager. Contractor may assign this Agreement to a corporation wholly owned by the Contractor, or to any entity in which the Contractor is a majority share holder.

10. BACKGROUND CHECK:

Contractor agrees that based upon the type of services to be provided, the Agreement is conditioned upon successful completion of a criminal background check, including any or all of the following; drug screening, credit check, reference check, past employment verification, and proof of education.

Contractor shall be responsible for maintaining current background checks on all employees involved in the performance of the Agreement. Background checks must be performed prior to the performance of any work by the employee under this Agreement. Written verification of all background checks must be provided to the Town Manager prior to the performance of any work by the employee under this Agreement. Contractor acknowledges that in the performance of the services contemplated in this Agreement, Contractor's employees may have contact with children. Accordingly, no employees shall be assigned to work for the Town under this Agreement whose background check reveals behavior which would prohibit such contact. Documentation of required certification and insurance must be provided to the Town prior to commencement of any instructional services by either Contractor or instructors hired by the Contractor.

11. PUBLIC RECORDS:

Contractor shall comply with the applicable provisions of Chapter 119, Florida Statutes. The Town shall have the right to immediately terminate this Agreement for the refusal by Contractor to comply with Chapter 119, Florida Statutes. Contractor shall retain all records associated with this Agreement for a period of three (3) years from the date of termination or expiration.

During the term of this Agreement and for three (3) years from the date of termination or expiration, Contractor shall allow Town representatives access during reasonable business hours to Contractor's records related to this Agreement for the purposes of inspection or audit of such records. If upon audit of such records, the Town determines Contractor was paid for services not performed, upon receipt of written demand by the Town, Contractor shall remit such payment to the Town.

12. NOTICES:

All notices and communications to the Town or Contractor shall be in writing and shall be deemed to have been properly given if transmitted by registered or certified mail or hand delivery or private delivery service. All notices and communications shall be effective upon receipt. Notices shall be addressed as follows:

Town: Town of Surfside, Florida
9293 Harding Avenue
Surfside, Florida 33154
ATTN: Town Manager
Telephone: (305) 861-4863
Facsimile: (305) 861-1302

Contractor: Eduardo Gabriel Alves
Cyclone Soccer Miami, Inc.
1001 91st Street #607
Bay Harbor, FL 33154

13. MISCELLANEOUS:

This Agreement constitutes the entire agreement of the parties with respect to the subject matter hereof and supersedes all prior agreements, written or oral, between the parties to this Agreement. This Agreement shall be binding upon and inure to the benefit of, and be enforceable by, the parties and their respective legal representatives, successors and assigns. Contractor may not assign its rights or obligations hereunder without the prior written consent to Town. No waiver by the parties of any default or breach of any term, condition, or covenant of this Agreement shall be deemed to be a waiver of any other breach of the same or any other term, condition or covenant contained herein. This Agreement shall be deemed to have been mutually drafted by the parties. Therefore, neither this Agreement nor any section hereof or amendment hereto shall be construed against any party due to the fact that the Agreement or any section hereof or amendment hereto may have been primarily drafted by said party. If any provision of this Agreement, or the applications of such provision to any person or circumstance, shall be held invalid the remainder of this Agreement or the application of such provision to persons or circumstances other than those as to which it is held invalid, shall not be affected thereby. Should any litigation be commenced between the parties thereto, the party prevailing in such litigation shall be entitled, in addition to such other relief as may be granted, to its costs and a reasonable sum for attorney's fees in such litigation and any appeal thereof or in bankruptcy proceedings. Venue in any litigation shall lie exclusively in Miami-Dade County, Florida. THE PARTIES HERETO WAIVE ALL RIGHT TO TRIAL BY JURY IN ANY ACTION, SUIT, OR PROCEEDING BROUGHT TO RESOLVE ANY DISPUTE, WHETHER IN CONTRACT, TORT OR OTHERWISE ARISING OUT OF, CONNECTED WITH, RELATED TO, OR INCIDENTAL TO THIS AGREEMENT.

IN WITNESS WHEREOF, the undersigned parties have executed this Agreement on the 1st day of April, 2020.

**TOWN OF SURFSIDE,
a Florida municipal corporation:**

Town Manager

ATTEST:

Town Clerk

APPROVED AS TO FORM AND LEGALITY
FOR THE USE AND BENEFIT OF
TOWN OF SURFSIDE ONLY:

Town Attorney

CONTRACTOR:

By: 
(Signature)

EDUARDO G. ALVAREZ
(Print Name)

1001 4157 street Apt 607
(Address)

23-1 HARBOUR ISLANDS, FL 33154



MEMORANDUM

ITEM NO. 2D

To: Honorable Mayor, Vice-Mayor and Members of the Town Commission
From: Guillermo Olmedillo, Town Manager
Date: June 23, 2020
Subject: Town's Zoning Code Review and Support

The Town Commission has begun the review of the Town's Zoning Code and has expressed interest in retaining review support services.

Wes Blackman, AICP, with CWB Associates, has provided a framework for work on the Town's Zoning Code and Town Commission's interest in creating a land development regulation structure that reflects the direction of the current Town Commission. The goal will be to produce a series of code amendments to achieve that end. Whether this entire task can be accomplished during this four (4) month period is impossible to guarantee, but the Town will be farther along addressing deficiencies in the existing code and have a more suitable framework for review of development applications.

These services include:

- Review of existing planning documents (Town Charter, Comprehensive Plan, Evaluation and Appraisal Report(s), Zoning Code/Land Development Regulations and Design Guidelines) and changes made to all of them over the past 10 or more years.
- Possible review of variance requests and those granted, along with individual development approvals over the same time period.
- Work with existing Town planning staff, Planning and Zoning board members (currently to-be-appointed) other Town staff and the Mayor/Town Commission.

These services would be paid for with Contingency funds from the General Fund. There is no need for a budget amendment.

Town Administration seeks direction on execution of a Professional Services Agreement with CWB Associates for 4 months of work for a flat fee of \$15,000 (\$3,750/month). The four (4) months of work would begin at contract execution.

Reviewed by: LA

Prepared by: JG

RESOLUTION NO. 2020 - _____

A RESOLUTION OF THE TOWN COMMISSION OF THE TOWN OF SURFSIDE, FLORIDA, APPROVING THE ENGAGEMENT OF CWB ASSOCIATES (C. WESLEY BLACKMAN, AICP) FOR PLANNING CONSULTING SERVICES FOR SUPPORT IN THE REVIEW OF THE TOWN'S ZONING CODE; FINDING THAT THE SERVICES ARE EXEMPT FROM COMPETITIVE PROCUREMENT PURSUANT TO SECTION 3-13(2) OF THE TOWN CODE; AUTHORIZING THE TOWN MANAGER TO EXECUTE A PROFESSIONAL SERVICES AGREEMENT FOR THE SERVICES; PROVIDING FOR IMPLEMENTATION; AND PROVIDING FOR AN EFFECTIVE DATE.

WHEREAS, the Town of Surfside (the "Town") wishes to engage a consulting planning firm to provide support in connection with the review of the Town's Zoning Code (the "Services"); and

WHEREAS, CWB Associates, and its principal, C. Wes Blackman (the "Consultant") have agreed to perform the Services pursuant to the Proposal attached hereto as Exhibit "A"; and

WHEREAS, Section 3-13(2) of the Town Code of Ordinances (the "Code") provides that certain contracts for professional services are exempt from the competitive bidding procedures of Chapter 3 of the Town Code; and

WHEREAS, the Town Commission finds that the Services are exempt from competitive bidding pursuant to Section 3-13(2) of the Town Code and wishes to approve the Consultant's Proposal attached hereto as Exhibit "A" to provide the Services for a four (4) month term in the amount of \$15,000.00; and

WHEREAS, the Town Commission wishes to authorize the Town Manager to enter into a Professional Services Agreement with the Consultant, in accordance with the Proposal attached

hereto as Exhibit “A”, and in form and substance as approved by the Town Manager and Town Attorney; and

WHEREAS, the Town Commission finds that this Resolution is in the best interest and welfare of the residents of the Town.

NOW, THEREFORE, BE IT RESOLVED BY THE TOWN COMMISSION OF THE TOWN OF SURFSIDE, FLORIDA, AS FOLLOWS:

Section 1. Recitals. That each of the above-stated recitals are hereby adopted, confirmed, and incorporated herein.

Section 2. Approval of Engagement; Town Manager Authorized to Enter into Professional Services Agreement. The Town Commission hereby approves the engagement of the Consultant for the Services in accordance with the Proposal attached hereto as Exhibit “A”. The Town Manager is authorized to enter into a Professional Services Agreement with the Consultant, in accordance with the Proposal attached hereto as Exhibit “A”, and in form and substance as approved by the Town Manager and Town Attorney for legal sufficiency.

Section 3. Implementation. The Town Commission hereby authorizes the Town Manager and Town officials to take any action which is reasonably necessary to implement the purposes of this Resolution.

Section 4. Effective Date. This Resolution shall become effective immediately upon adoption.

PASSED AND ADOPTED on this 23rd day of June, 2020.

Moved By: _____
Second By: _____

FINAL VOTE ON ADOPTION

Commissioner Charles Kesl _____
Commissioner Eliana R. Salzhauer _____
Commissioner Nelly Velasquez _____
Vice Mayor Tina Paul _____
Mayor Charles W. Burkett _____

Charles W. Burkett, Mayor

ATTEST:

Sandra McCready, MMC
Town Clerk

**APPROVED AS TO FORM AND LEGALITY FOR THE USE
AND BENEFIT OF THE TOWN OF SURFSIDE ONLY:**

Weiss Serota Helfman Cole & Bierman, P.L.
Town Attorney

Exhibit “A”

Proposal

Framework for work on the Town's Zoning Code

There is uncertainty in the amount of hours and number of meetings this effort will take. It will require review of existing planning documents (Town Charter, Comprehensive Plan, Evaluation and Appraisal Report(s), Zoning Code/Land Development Regulations and Design Guidelines) and changes made to all of them over the past 10 or more years. It may also involve review of variance requests and those granted, along with individual development approvals over the same time period. This effort will also involve work with existing Town planning staff, Planning and Zoning board members (currently to-be-appointed) other Town staff and the Mayor/Town Commission. This will include my participation in meetings and any travel.

I am offering these services for a flat fee of \$15,000 to include work during the next four months. At my hourly rate, this equates to approximately 20 hours of time per month. Given that it is a flat rate, I will not artificially limit my time and perform the work that must be done to accommodate the Town's needs in creating a land development regulation structure that reflects the direction of the current Town Commission. The goal will be to produce a series of code amendments to achieve that end. Whether this entire task can be accomplished during this four (4) month period is impossible to guarantee, but the Town will be farther along addressing deficiencies in the existing code and have a more suitable framework for review of development applications.

I request that the Town pay \$3,750 to me (CWB Associates) in advance of beginning work on this project. That payment would retain my services and the additional three (3) payments of the same amount would be paid monthly in advance. At the end of the contract term, we can evaluate our relationship at that time. This would include the work completed and the work left to be accomplished with no obligation on the part of either party to continue this arrangement.

RESOLUTION NO. 20-__

A RESOLUTION OF THE MAYOR AND TOWN COMMISSION OF THE TOWN OF SURFSIDE, FLORIDA, CONDEMNING THE ALLEDGED CRIMINAL ACTIONS OF THE MINNEAPOLIS POLICE OFFICERS INVOLVED IN THE DEATH OF GEORGE FLOYD, EXTENDING CONDOLENCES TO THE FAMILY OF GEORGE FLOYD FOR THEIR LOSS, AND SUPPORTING THE FLOYD FAMILY BY WAY OF A CALL FOR TRUE SOCIAL JUSTICE, RACIAL EQUALITY AND BY WAY OF OTHER INITIATIVES OUTLINED HEREIN; PROVIDING FOR TRANSMITTAL; AND PROVIDING FOR AN EFFECTIVE DATE.

WHEREAS, the Town of Surfside (the “Town”), its Mayor, Vice Mayor, Town Commission, Town Manager, staff and employees town-wide, were shocked and are saddened by the death of George Floyd; and

WHEREAS, the Town stands firmly in its support of racial equality and true social justice, and with the family of George Floyd and the rest of America in the struggle against racism and injustice perpetrated by some police, some prosecutors and some lawmakers; and

WHEREAS, the Town Commission believes in the United States Constitution and its democratic principles that define and govern our Country, which must be honored and enforced universally, regardless of race, sex, religion or economic status; and

WHEREAS, on May 25, 2020, George Floyd, a 46-year-old black man, was killed by police in Minneapolis, Minnesota during an arrest for allegedly committing a minor nonviolent crime; and

WHEREAS, police officer actions during the arrest included kneeling on Mr. Floyd's neck for 8 minutes and 46 seconds until he became unresponsive, leading to his death; and

WHEREAS, the basic duties of police are maintaining public safety, enforcing the law, and preventing, detecting, and investigating criminal activities; and

WHEREAS, the conscious use of excessive force by some officers is a betrayal of the oath police take to protect and serve and extinguishes the public's confidence in police; and

WHEREAS, the resulting community distrust cultivates tension and revulsion towards police, often culminating in violent protests that have the potential to destroy the Nation's social fabric; and

WHEREAS, it is our Commission's duty to foster a community free of inequality, fear, intimidation, and violence – a community in which peaceful, non-violent citizens are not shown disrespect, targeted or hurt by law enforcement, but rather supported and protected by them; and

WHEREAS, the Town Commission, along with its Charter Officials and Staff, pledge to lead by example in taking concrete action to deny inequity of any kind in our Town as outlined herein; and

WHEREAS, the residents of the Town are urged to join our Town Commission, along with its Charter Officials and Staff in addressing this very complex and real problem in our society by standing up for equality and against discrimination through copious amounts of speech to power and peaceful action; and

WHEREAS, the Town Commission reaffirms our commitment to the larger goals of true social justice and full equality across every spectrum; and

WHEREAS, the Town Commission strongly supports the First Amendment constitutional right of Americans to peaceably assemble and petition their government for

redress of grievances, and condemns, in the strongest possible terms, the use of such peaceable assemblies for violence in any form, destruction of property and/or other criminal acts;

WHEREAS, the Town Commission finds that this Resolution is in the best interest of the public health, welfare, and safety of the Town's residents.

NOW, THEREFORE, BE IT RESOLVED BY THE MAYOR AND TOWN COMMISSION OF THE TOWN OF SURFSIDE, FLORIDA, THAT:

Section 1. Recitals. The above recitals are true and correct and are incorporated herein by this reference.

Section 2. Declaration. The Town Commission hereby (1) condemns the alleged criminal bad acts of the Minneapolis police officers involved in the death of George Floyd, (2) extends condolences to the family of George Floyd for their tragic loss, and (3) supports the Floyd Family in its call for justice, racial equality and peace following the incident and (4) given the Town Commission wishes to go beyond simply making platitudinal statements;

Section 3. We Hereby Support the Following Sensible Solutions for Immediate Implementation.

- 1) The right of citizens to sue and receive remuneration from those police, prosecutors and lawmakers who knowingly or repeatedly, two or more times, violate the civil or Constitution rights of citizens.
- 2) A national database of fired or dismissed police officers.
- 3) A prohibition against hiring police candidates with criminal records and/or those who have been fired related to use of force violations.

- 4) A prohibition against undisclosed settlement agreements for those police, prosecutors and lawmakers who knowingly or repeatedly, two or more times, violate the civil or Constitution rights of citizens.
- 5) The abolition of all Police Department Internal Investigations Units and the implementation of independent review boards to replace same.
- 6) The elimination of all laws which prevent the termination of police officers with a record of 'use of force' complaints as follows; Any police officer, whose 'use of force' complaints shall be more than 40% higher than the average of the entire police force for which said officer works, shall be subject to immediate termination after review by an independent review board.
- 7) The establishment of low income Black Opportunity Zones with extreme tax concessions, for a period of 10 years, such as zero Federal and State income taxes for Black residents, workers and property owners who will save or invest those income tax savings into; educational opportunities, new or existing businesses or the purchase or renovation of a home in said Opportunity Zone.
- 8) Police departments shall be prohibited from owning or utilizing military style hardware or weaponry; however, each County in the State shall have a rapid response, SWAT type force, that does employ said military style hardware and weaponry for the purpose of providing support to any agency requesting said assistance, but only on an emergency basis. Said County SWAT style force shall not report to said County, but only to State authorities who shall manage said force.

- 9) The right of Black families to not have to send their children to failing schools by giving them the right to choose the school that they want their children to attend, funded either by the State or Federal Government issuing vouchers, or by way of direct payments to the schools.
- 10) Incentivize businesses to hire and train Black workers by implementing a tax credit, equal to 50% of the wage paid to each worker earning up to and including, \$40,000 per year. Said tax credit would be available to any business, for each worker, for a period of 5 years. Each Black worker would be entitled take any remaining tax credit time with him/her to a new job should a job change be desired or required.

Section 4. **Transmittal.** The Town Clerk is hereby directed to transmit a copy of this Resolution to the United States Department of Justice.

Section 5. **Effective Date.** This Resolution shall be effective immediately upon adoption.

PASSED and ADOPTED this 23rd day of June, 2020.

CHARLES W. BURKETT,
Mayor

Attest:

SANDRA MCCREADY, MMC
Town Clerk

APPROVED AS TO FORM AND LEGAL SUFFICIENCY FOR THE
SOLE USE OF THE TOWN OF SURFSIDE:

WEISS SEROTA HELFMAN COLE & BIERMAN, P.L.
Town Attorney

Moved By: _____
Seconded By: _____

FINAL VOTE AT ADOPTION:
Commissioner Charles Kesl _____
Commissioner Eliana R. Salzhauer _____
Commissioner Nelly Velasquez _____
Vice Mayor Tina Paul _____
Mayor Charles W. Burkett _____

RESOLUTION NO. 2020 -

A RESOLUTION OF THE MAYOR AND TOWN COMMISSION OF THE TOWN OF SURFSIDE, FLORIDA, IN SUPPORT OF THE BLACK LIVES MATTER MOVEMENT AND THE TOWN OF SURFSIDE'S COMMITMENT TO RACIAL EQUALITY; PROVIDING FOR IMPLEMENTATION; PROVIDING FOR TRANSMITTAL; AND PROVIDING FOR AN EFFECTIVE DATE.

WHEREAS, the Town of Surfside (the "Town"), its Mayor, Vice Mayor, and Town Commission acknowledge that Black Lives Matter; and

WHEREAS, the Town acknowledges that over the course of the past few months, we have been again reminded that police brutality and general disregard for Black people's lives is prevalent within the United States; and

WHEREAS, the Town acknowledges that this continued assault on Black people has caused the the loss of numerous lives for no reason other than racist biases; and

WHEREAS, incidents such as the murders of George Floyd, Breonna Taylor, Ahmaud Arbery, Rayshard Brooks and others (tragically too many to specify herein) and all of the other countless Black people who have been murdered by the unjustifiable use of excessive force by both uniformed officers (on or off-duty) and civilian vigilantes, who saw a black body and equated it with a threat; and

WHEREAS, incidents such as these show that there is systemic and a prolific nature to racism built into the foundation of the United States and as such these actions go on without proper recognition, adjudication, or conviction; and

WHEREAS, racial profiling and abuse of power happens domestically here in the United States, in the State of Florida, and in Miami Dade County; and

WHEREAS, the Town of Surfside, its Mayor, Vice Mayor, and Town Commission share the pain and anger of Black people in our county, state, and nation; and

WHEREAS, we stand in solidarity with the Black community, and strive to hold our Town departments and ourselves to the only standards that will begin to protect us, one of equity and justice that centers all people, not just those with the most privilege; and

WHEREAS, now is a time for action, and we cannot be inactive in addressing this issue,

and the Town Commission finds that this Resolution is in the best interests of its residents and the community.

NOW, THEREFORE, BE IT RESOLVED BY THE TOWN COMMISSION OF THE TOWN OF SURFSIDE, FLORIDA, AS FOLLOWS:

Section 1. Recitals. That each of the above-stated recitals are hereby adopted, confirmed, and incorporated herein.

Section 2. In Support of Blacks Lives Matter and Commitment to Racial Equality.
The Town Commission hereby supports Black Lives Matter and racial equality for all people, and commits to take the following actions in support of racial equality:

1. To work with community members and staff to acknowledge and address the root causes of inequities in Town services and outcomes.
2. To work with community members and staff to identify and implement policies that can eliminate the racial inequities that exist.
3. To use an antiracist and racial equity lens to assess current and future policies and programs.
4. To communicate with the community, Town employees and its Police Department about the root causes of racial inequity as well as the corrective action that has been or will be taken.
5. When policies fail, the Town of Surfside will wholeheartedly and enthusiastically start over and seek out new and more effective antiracist policies until they work.

Section 3. Transmittal. The Town Clerk is hereby directed to transmit a copy of this Resolution to the United States Department of Justice.

Section 4. Effective Date. This Resolution shall become effective immediately upon adoption.

PASSED AND ADOPTED on this 23rd day of June, 2020.

Moved By: _____
Second By: _____

FINAL VOTE ON ADOPTION

Commissioner Charles Kesl
Commissioner Eliana R. Salzhauer
Commissioner Nelly Velasquez
Vice Mayor Tina Paul
Mayor Charles W. Burkett

Charles W. Burkett, Mayor

ATTEST:

Sandra McCready, MMC
Town Clerk

**APPROVED AS TO FORM AND LEGALITY FOR THE USE
AND BENEFIT OF THE TOWN OF SURFSIDE ONLY:**

Weiss Serota Helfman Cole & Bierman, P.L.
Town Attorney



MEMORANDUM

ITEM NO. 4B

To: Honorable Mayor, Vice-Mayor and Members of the Town Commission
From: Guillermo Olmedillo, Town Manager
Date: June 23, 2020
Subject: Inhouse Landscape Cost

At the March 31, 2020 Special Commission Meeting, Town Administration was directed to provide a cost for the in-house services of landscape scope of work currently contracted with outside vendor.

Please find attached requested report being provided with this communication.

Reviewed by: HG/RS

Prepared by: HG



Town of Surfside
Public Works Department
In-house Landscape

First Year Operating Costs
(Includes start up cost due to equipment and vehicle purchases)

Item No.	Resource	Resource Type	First Year Cost
1.00 - Labor Resource (Personnel)			
1.01	Greenspace Worker II	Labor	\$52,060.00
1.02	Greenspace Worker I	Labor	\$46,580.00
1.03	Greenspace Worker I	Labor	\$46,580.00
1.04	Arborist	Consultant Professional	\$4,000.00
Section 1.00 Total			\$149,220.00
2.00 - Equipment Resource (Vehicle & Landscape Equipment)			
2.01	Lawn Mower (Stand behind)	Equipment	\$10,388.00
2.02	Lawn Mower (Push Behind)	Equipment	\$1,259.00
2.03	Small Equipment	Equipment	\$2,245.00
2.04	Trailer (7 x 16)	Equipment	\$5,199.00
2.05	Vehicle (Tilt Cab)	Equipment	\$58,058.81
Section 2.00 Total			\$77,149.81
3.00 - Operating Costs (Costs incurred by the operation)			
3.01	Fuel	Operating	\$15,000.00
3.02	Vegetation Disposal	Operating	\$36,400.00
3.03	Small Equipment Maintenance	Operating	\$2,034.00
3.04	Large Equipment Maintenance	Operating	\$3,000.00
3.05	Uniforms	Operating	\$11,400.00
3.06	Toll	Operating	\$1,000.00
Section 3.00 Total			\$68,834.00
<i>Total first year start up and operating cost</i>			\$295,203.81
<i>Total first year start up and operating cost with 10% Contingency</i>			\$324,724.19

Notes:

- Items in section 3.00 are subject to fee increases by County and / or market rate increases.
- Table provides basic maintenance service costs. Does not include purchase of landscape material.
- Table Provides basic maintenance service costs. Does not include emergency work.
- Table Provides basic maintenance service costs. Does not include Insecticide and fertilization.
- Table Provides basic maintenance service costs. Does not include speciality tree treatment or care.



Town of Surfside
Public Works Department
In-house Landscape

After Year One Operating Cost
(Does not include start up cost)

Item No.	Resource	Resource Type	First Year Cost
1.00 - Labor Resource (Personnel)			
1.01	Greenspace Worker II*	Labor	\$52,060.00
1.02	Greenspace Worker I*	Labor	\$46,580.00
1.03	Greenspace Worker I*	Labor	\$46,580.00
1.04	Arborist	Consultant Professional	\$4,000.00
Section 1.00 Total			\$149,220.00
2.00 - Equipment Resource (Vehicle & Landscape Equipment)			
2.01	Replace of Equipment (5 year Cycle)	Equipment	\$15,430.00
Section 2.00 Total			\$15,430.00
3.00 - Operating Costs (Costs incurred by the operation)			
3.01	Fuel	Operating	\$15,000.00
3.02	Vegetation Disposal	Operating	\$36,400.00
3.03	Small Equipment Maintenance	Operating	\$2,034.00
3.04	Large Equipment Maintenance	Operating	\$3,000.00
3.05	Uniforms	Operating	\$11,400.00
3.06	Toll	Operating	\$1,000.00
Section 3.00 Total			\$68,834.00
<i>Annual operating cost</i>			\$233,484.00
<i>Annual operating cost with 10% Contingency</i>			\$256,832.40

Notes:

- *This item is subject to a cost of living and / or merit raise.
- Items in section 3.00 are subject to fee increases by County and / or market rate increases.
- Table provides basic maintenance service costs. Does not include purchase of landscape material.
- Table Provides basic maintenance service costs. Does not include emergency work.
- Table Provides basic maintenance service costs. Does not include Insecticide and fertilization.
- Table Provides basic maintenance service costs. Does not include speciality tree treatment or care.



MEMORANDUM

ITEM NO. 4D

To: Honorable Mayor, Vice-Mayor and Members of the Town Commission

From: Guillermo Olmedillo, Town Manager

Date: June 23, 2020

Subject: Miami Christmas Lights Contract. Holiday Lights for the Town of Surfside

Vendor Miami Christmas Lights (MCL), was selected as a result of RFP 2019-01, Holiday Lights for the Town of Surfside.

The vendor presented three (3) options to the Tourist Board at the June 2019 Tourist Board meeting and fielded questions. The Tourist Board voted to move forward with the current design, then option two (2), at the July meeting. A motion was made by Vice Chair Lehman and was seconded by then Tourist Board member Kesl (all voted in favor). The annual price for the project is \$86,700.

The Town has a three-year agreement with the vendor, although signed authorization from the Town is required each year. If authorization is given to proceed, 2020 would be year two of service. The agreement provides for termination without cause upon five (5) days written notice from the Manager and further contains a budget/appropriation condition precedent.

The Town's rights of termination and election not to move forward would not present a problem under the Agreement.

MCL has provided three additional options for the Town of Surfside for the next season.

Estimate 51, Exhibit 1, removes the higher concentration of lights at the top of the palm trees which create a 'crown' effect for \$62,600.

Estimate 50, Exhibit 2, omits both the crowns and the illuminated spheres placed throughout the pocket parks on Harding Avenue for \$53,000.

Reviewed by

Prepared by

The Holiday Décor Project Estimate maintains the \$86,000 price, but adds a \$15,000 credit from the vendor that would go add an additional daytime lighting element to the installation.

Additionally, the Town Administration is looking into options to execute the lights in-house with the potential assistance of an electrical vendor for installation and maintenance support. This would require purchasing the lighting equipment and the support of Public Works. Because of the difficulty with storage space and the time required to purchase and install all the necessary components, this would be challenging to execute this coming season. Potential overtime budget for Public Works should also be considered.

As a final option, the Town Administration asked vendor MCL if a permanent lighting option is available. While a few of their clients do have this option in place, it was not recommended due to the substantial maintenance issue that arise annually. These include exposure to the elements, the effects of landscaping and considerable dimming from the burn time on the LED given increased usage.



MEMORANDUM

ITEM NO. 4E

To: Honorable Mayor, Vice-Mayor and Members of the Town Commission
From: Guillermo Olmedillo, Town Manager
Date: May 22, 2020
Subject: Beach Re-opening

Today, May 22, 2020, Miami Dade County announced the re-opening of the beaches on June 1st, 2020. The anticipated beach hours of operation for the month of June are from 9 am to 6 pm. At this time the hours and guidelines have not been issued. We do not know what the New Normal guidelines will be.

The existing five full-time lifeguards will be able cover beach operations with minimal enforcement.

The Parks and Recreation Department is requesting that three part time lifeguards are put back on payroll to assist with enforcement of beach guidelines, complete pool maintenance activities and prepare for pool reopening, and provide back up if a full-time staff is unable to come to work due to illness or family emergencies.

Please note that the backup staff is essential in case of an emergency. Without the backup the necessary beach coverage and hours of operation will be compromised.

With the impact of the beach re-opening two Zoom programs that the lifeguards are associated with will have to be dropped.

A request for the rehire of remaining part time lifeguards will be necessary in order to re-open the pool once a date and time is established for public pools reopening.

Reviewed by: EH/TM

Prepared by: EH/TM

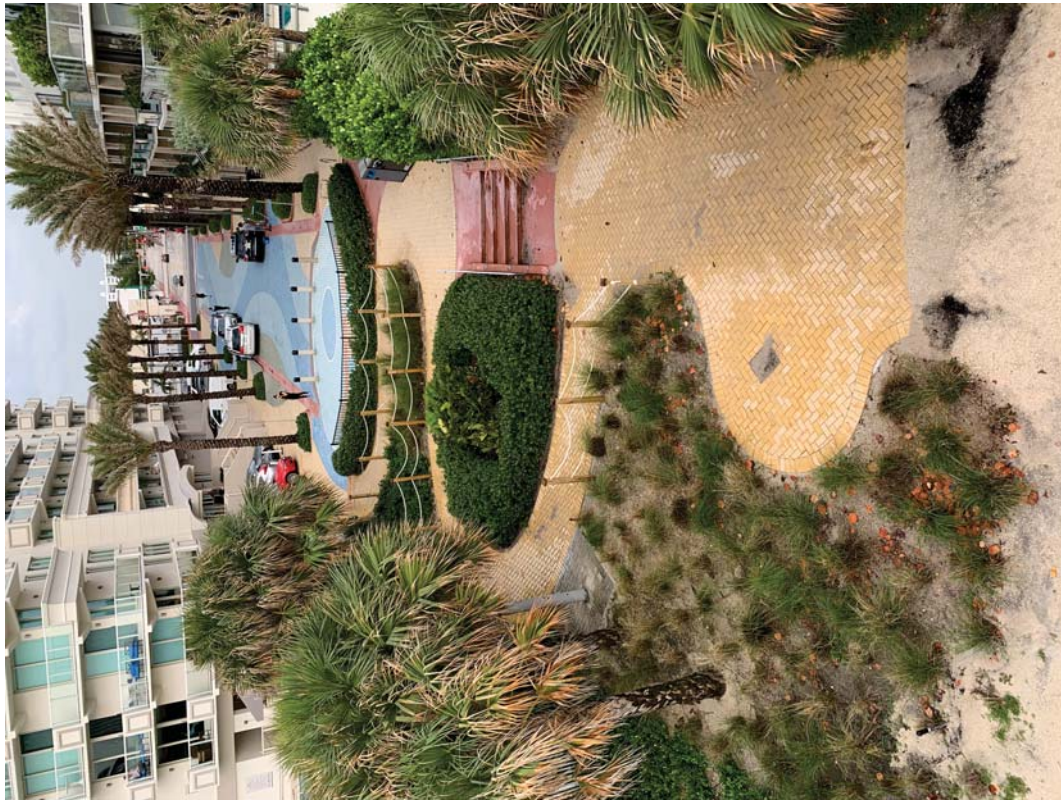

LAST
REVISION
05/19/2020

DESCRIPTION:
FINALIZED BEACH END AT 95TH STREET DEVELOPED IN 2014. AERIAL
FROM EAST FACING WEST



TOWN OF SURFSIDE

95TH STREET BEACH-END

SCALE:
N.T.S.

SHEET
1 of 1

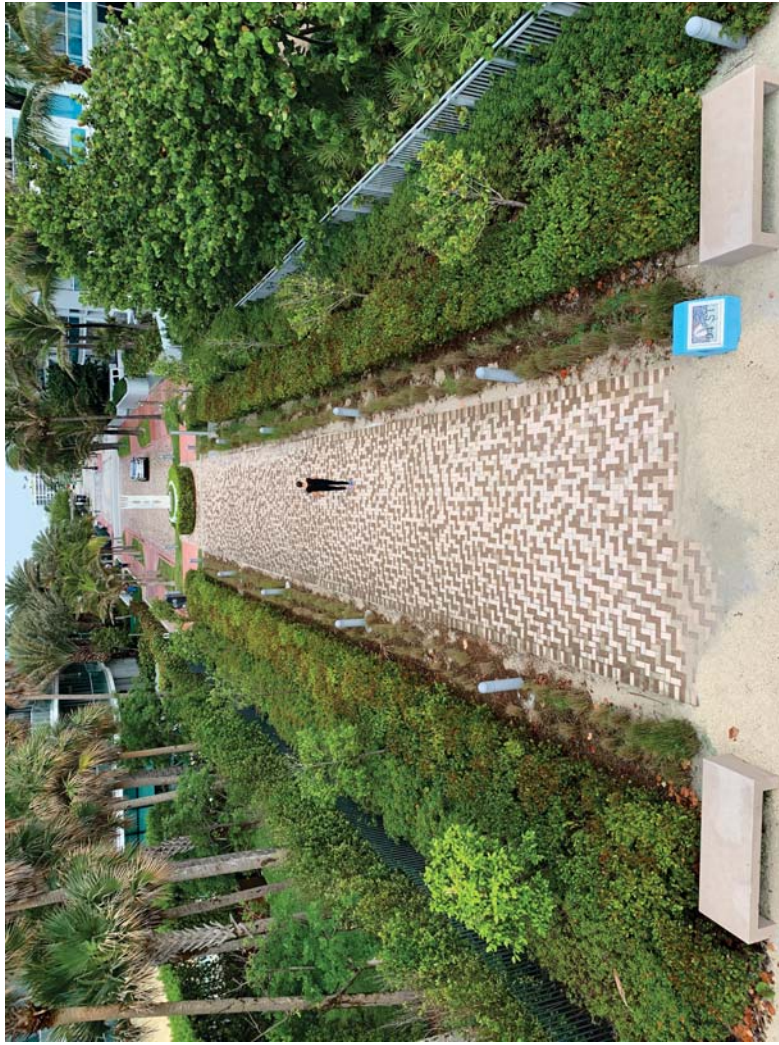
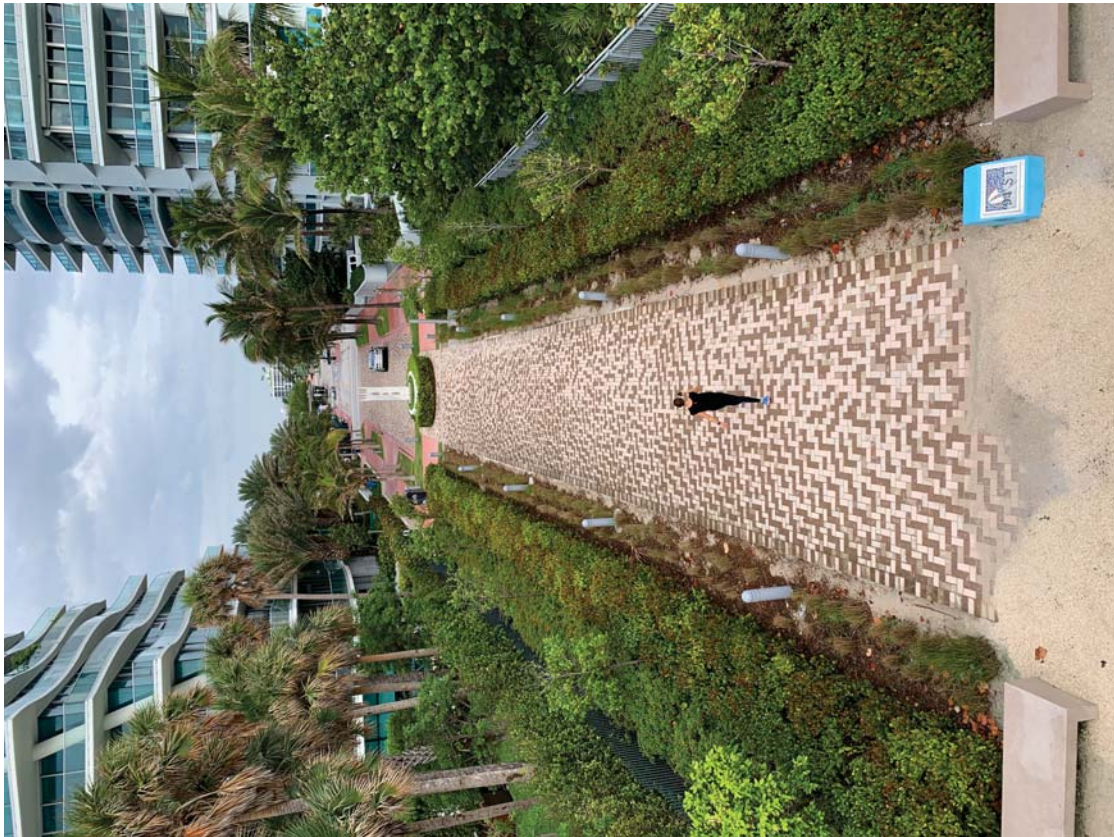

LAST
REVISION
05/19/2020

DESCRIPTION:
FINALIZED BEACH END AT 94TH STREET DEVELOPED IN 2016. AERIAL
FROM EAST FACING WEST



TOWN OF SURFSIDE

94TH STREET BEACH-END

SCALE:
N.T.S.

SHEET
1 of 1

TOWN OF SURFSIDE

Public Works Department

“92nd Street Beach End Improvements Phase I”

March 19, 2020

9293 HARDING AVENUE,
SURFSIDE, FL 33154
PHONE: (305) 861-4863

Prepared By:



Public Works Department



OVERVIEW

During fiscal year 2019-2020, the Town Commission approved expenditures for the improvements of 92nd Street Beach End. Current fiscal year account number for the project is 301-4400-541-63-95. The project is to be performed in two phases. Phase I is the development of areas east of bulkhead which is the current concrete band where current stairs exist. Phase I will convert areas east of bulkhead ADA compliant while beautifying the extents. ADA compliance will be obtained by creating a sloped walkway from the bulk head to the hardpack similar to 94th Street beach end developed in 2017. The walking surface will be paver set on limerock base with a perimeter concrete band. The walkway will be 15 feet wide by approximately 90 feet long. Paver specifications are provided in **Attachment A** – “*Material Specifications*”. Phase I will include the development of two landscape isles each 17 feet wide by approximately 90 feet long along each side of the paver walkway. Currently, there are 10 existing coconut palms that will be re-configured to 5 on each side of equal spacing. The ground cover will consist of *Ficus microcarpa* (green island ficus) and *Clusiaceae* (clusia) which are native Florida species approved by Florida Department of Environmental Protection (FDEP) and are of high resiliency for beach conditions. Refer to **Attachment B** – “*Project Drawings for Configuration*”.

Additionally, a drainage system will be installed to provide drainage of shower run-off. The drainage system will consist of a yard drain structure along with 40 linear feet of exfiltration trench. The drainage will be placed into operation with the current shower but will be connected to any Phase II development at a later time. Refer to **Attachment B** – “*Project Drawings for Configuration*” for a Civil Schematic drawing. Due to the nature of the project on State jurisdiction land, fill from on-site needs to be used for the development of lands. The Town has stock-piled sand fill on a private property located at 8800 Collins Ave and along with fill excavated from the exfiltration trench, will attempt to balance the site as required for the ADA compliance grade. Additionally, the grading of the north side of the Phase I will allow for additional fill for use. An additional 50 cubic yard of beach quality sand and 30 cubic yards of limerock will need to be purchased to achieve a balanced site and provide stabilization for pavers.

Lastly, extents of the site will be defined using an aluminum picket style fence along both running perimeters on the north and south side of the property. Bollard lighting with amber fixtures will be installed on each side of the walkway for sundown illumination. The lighting fixtures are the same specification as 94th Street beach end and are amber to allow for turtle lighting approval. Amber lighting does not impact turtles since they are of a light frequency not detected by turtles. A complete project schedule can be found in **Appendix C** - *Project Schedule and Project Budget Estimate*”. This project will be performed internally by the Public Works Department along with specialty contractors managed by the Department. Project management will be performed by the Public Works Department. Project Budget Estimate has a schedule column outlining the procurement process for each activity. The schedule start date is tentative permit approval and commission approval of plan. At this time, Phase II is not budgeted for but left over funds can be carried over for development.



Attachment A
“Material Specifications”.



Town of Surfside Public Works Department

Product Specification Sheet

Paver Walkway



QUARTZSTONE 12X12

PRODUCT CODE: PV21440

THICKNESS: 2-3/8" (60MM)

DIMENSIONS: 12" X 12"

SF PER CUBE: 120

CUBE WEIGHT: 3120

Note: 10 week lead time on product



Town of Surfside Public Works Department

Product Specification Sheet

Landscape Specification



CLUSIA 7 GALLON



GREEN ISLAND FICUS



TRIM ALL PALM TREES REMOVE PALM TREES TO ADJACENT LOCATION FOR STORAGE.

INSTALL 10 COCONUT PALMS BACK TO 92ND STREET AS PER PLANS.



Town of Surfside Public Works Department

Product Specification Sheet

North and South Fence Detail

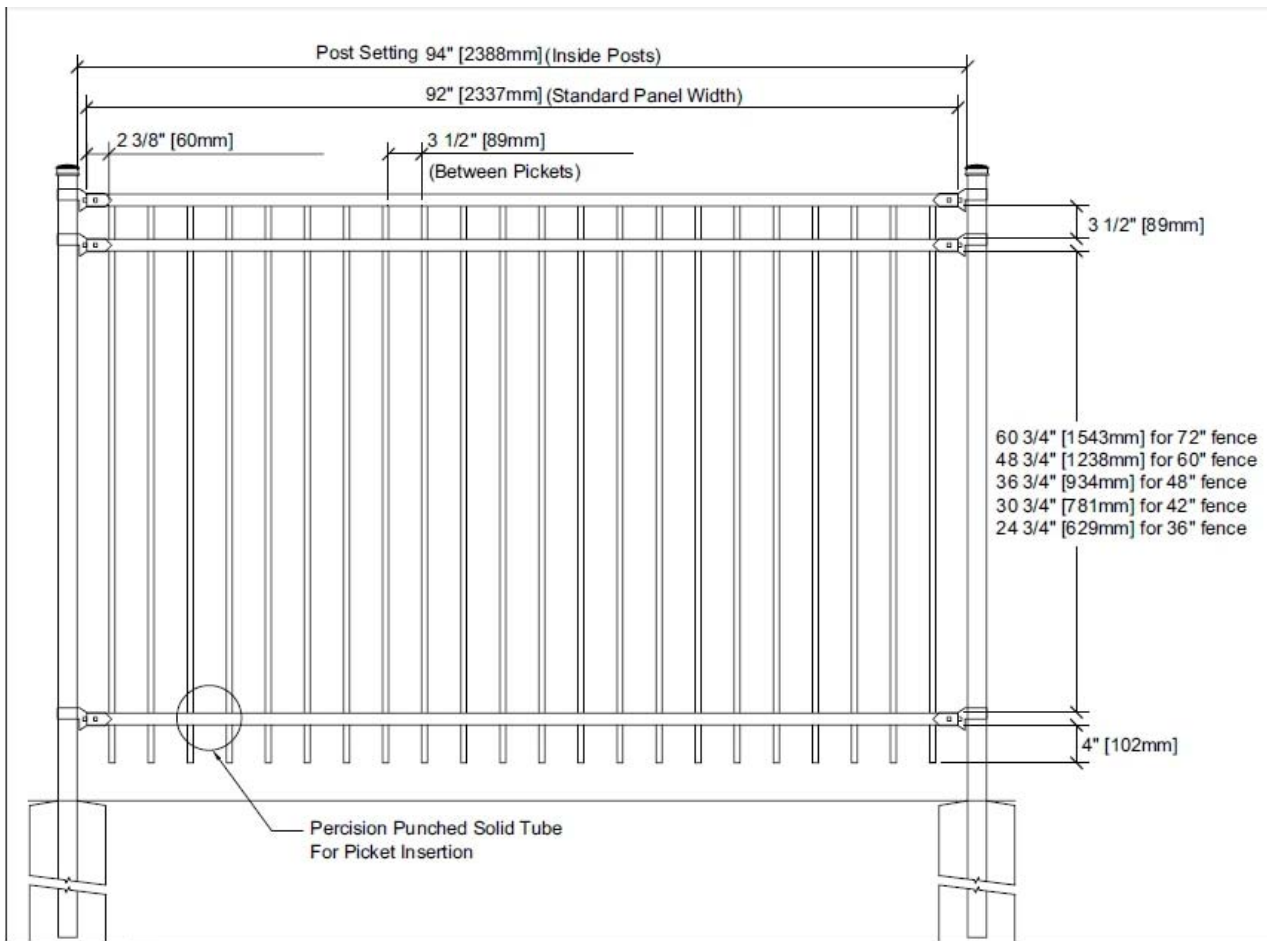



Town of Surfside Public Works Department

Product Specification Sheet

Bollards



Amber Lighting for Sea Turtle Conditions

Product Overview

Highlights:

- Engineered and manufactured in Wisconsin, USA from domestic and imported components
- ETL Certified: Conforms to UL STD 1598 & CSA STD C22.2 # 250.0 for wet locations
- L70 calculated LED life over 136,500+ hours
- Drivers are 0-10v dimming standard
- Four light engine options from 1,443 – 5,421 lumens, custom options available upon request
- Premium high-output Chip-On-Board (COB) LEDs in 5700K, 5000K, 4000K, 3000K and 2700K options, custom color temps available upon request
- Minimum CRI of 90, custom CRI available

Common Applications:

- Building entrances
- Path and walkways
- Architectural and landscape lighting
- Accent and general lighting

Light Engine Warranty:

- 5-year standard limited warranty on all light engine components
- Accessories and adders covered by separate OEM supplier warranties

Note: 8 week lead time on all amber products



Attachment B
“Project Drawings for Configuration”



SCOPE OF WORK

1. BEACH ACCESS AT 92nd STREET EAST OF COLLINS AVENUE
2. PROPOSED 10' WIDE CONCRETE WALKWAY WITH 8" RISERS OF 48" HEIGHT EACH TO COVER CHANGE IN LEVEL OF 38" BETWEEN STREET AND DIRT WAY.
3. PROPOSED NEW 1:22 RAMP FOR WHEELCHAIR ACCESSIBILITY SURROUNDING EXISTING PALM TREES.
4. NEW GUARDRAIL WHERE CHANGE IN LEVEL GREATER THAN 30" HIGH.

PROPOSED SITE PLAN
SCALE: 1/4" = 1'-0"

CERTIFICATE OF AUTHORIZATION #: 26074
P.E. #: 14170
12355 SW 129 CT. SUIT 4
MIAMI, FLORIDA 33186
PHONE: (305) 251-9177
FAX: (305) 251-8372
ALFREDO M. CARBONELL, P.E. Inc.

NO.	DATE	REVISIONS

TOWN OF SURSIDE
Client:
Project:
92nd STREET BEACH ACCESSIBLE PATHWAY
9293 HARDING AVENUE SURSIDE, FL 33154

PROPOSED SITE PLAN
Plan Description:
Sheet:

FLA. REG. P.E. # 14170
Drawn by:
ALFREDO M. CARBONELL
Checked by:
ENICK FLORIDO
Date:
SEPTEMBER 10, 2018
Scale:
AS SHOWN
Job No.:
2018-0910

Sheet:
A.100
X of X Sheets

CERTIFICATE OF AUTHORIZATION #: 26074
 P.E. #: 14170
 12355 SW 129 CT, SUIT 4
 MIAMI, FLORIDA 33186
 PHONE: (305) 251-9177
 FAX: (305) 251-8372
ALFREDO M. CARBONELL, P.E., Inc.

NO.	DATE	REVISIONS

Client: **TOWN OF SURFIDE**
 Project: **92ND STREET BEACH ACCESSIBLE PATHWAY**
 9293 HARDING AVENUE SURFIDE, FL 33154

Plan Description: **PROPOSED SITE PLAN**

Sheet:
 FLA. REG. P.E. # 14170

Designed by: **ALFREDO M. CARBONELL**
 Drawn by: **ENICK FLORIDO**
 Review & Seal: **ALFREDO M. CARBONELL**
 Date: **SEPTEMBER 10, 2018**
 Scale: **AS SHOWN**
 Job No.: **2018-0910**

Sheet: **A.100**
 X of X Sheets



SCOPE OF WORK

1. BEACH ACCESS AT 92ND STREET EAST OF COLLINS AVENUE.
2. PROPOSED 10' WIDE CONCRETE WALKWAY WITH 8" RISERS OF 48" HEIGHT EACH TO COVER CHANGE IN LEVEL OF 38" BETWEEN STREET AND DIRT WAY.
3. PROPOSED NEW 1:28 RAMP FOR WHEELCHAIR ACCESSIBILITY SURROUNDING EXISTING PALM TREES.
4. NEW GUARDRAIL WHERE CHANGE IN LEVEL GREATER THAN 30" HIGH.

PROPOSED SITE PLAN
 SCALE: 1/4" = 1'-0"

PAVERS (REFER TO SPECIFICATION)

6"X4" CONCRETE BAND

SAND BASE FOR PAVERS

12" LIMEROCK BASE

SOIL SUBGRADE - ZERO SLOPE

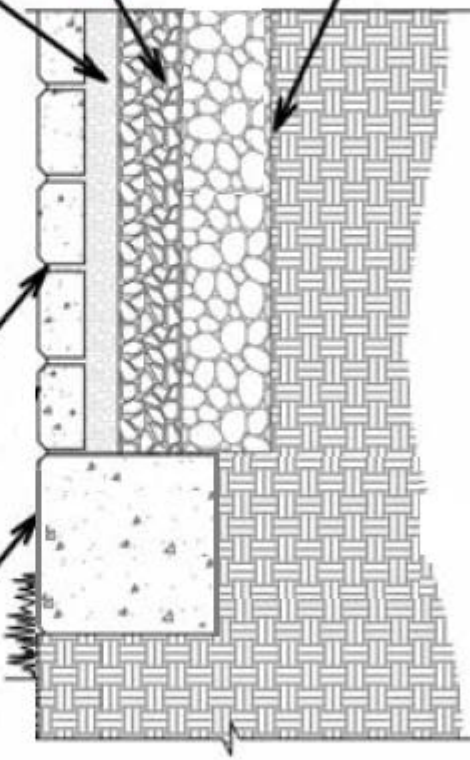

CIVIL SCHEMATIC DRAWING
N.T.S
03/19/2020

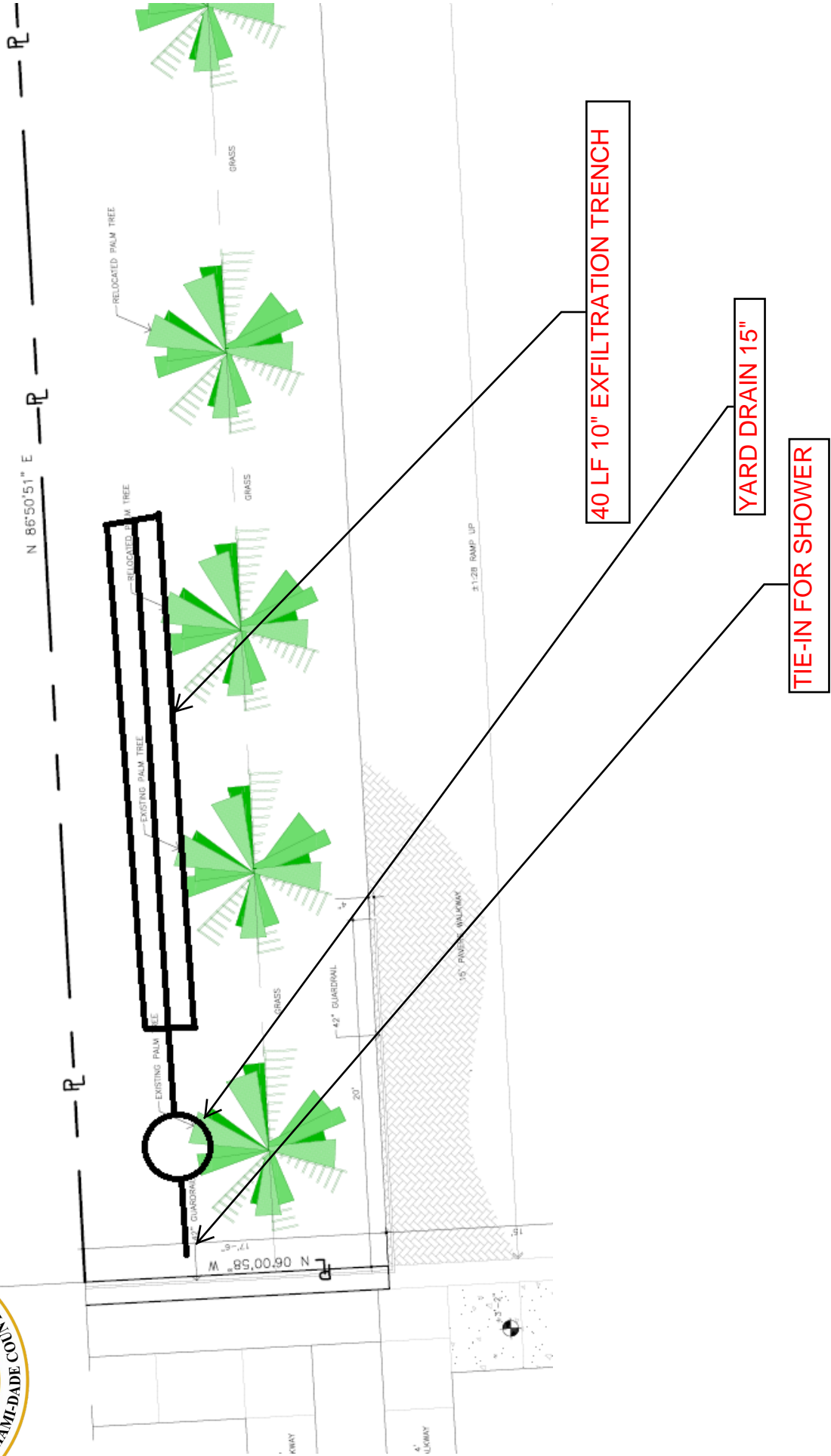



Attachment C
"Project Schedule and Project Budget Estimate".



2nd Street Beach End Project

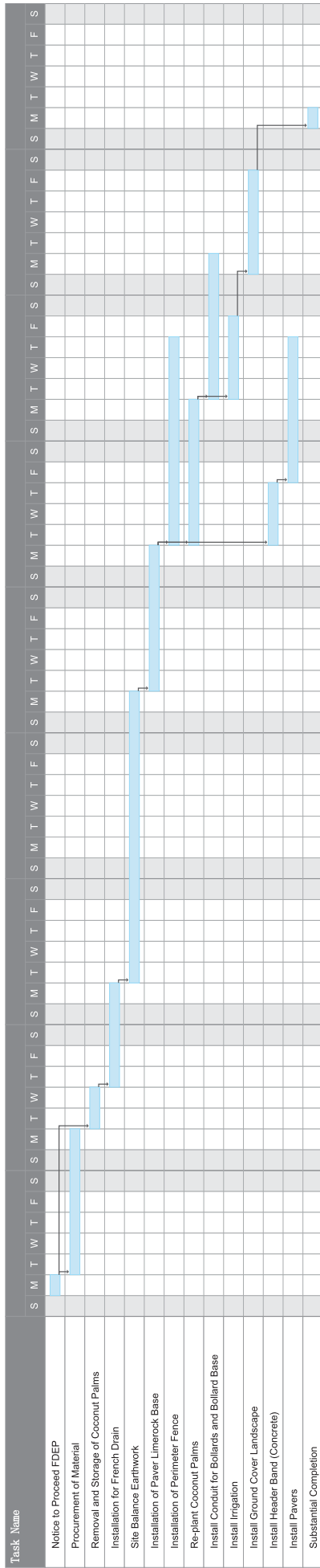



Town of Surfside
Public Works Department
92nd Street Beach End Project Estimate

Item Number	Activity	Cost	Procurement Method	PO
1	Landscaping (Full Scope)	\$14,000.00	Brightview Contract Schedule of Value	YES
2	Civil (Drainage Material)	\$6,000.00	Material Purchase within Spending Authority	YES
3	Perimeter Fencing	\$5,200.00	Material Purchase within Spending Authority	YES
4	Electrical (Bollards)	\$13,500.00	Procurement of Contractor Lowest Bidder	YES
5	Paver Material	\$7,000.00	Material Purchase within Spending Authority	YES
6	Paver Installation	\$8,000.00	Procurement of Contractor Lowest Bidder	YES
7	Earthwork (Fill)	\$6,000.00	Material Purchase within Spending Authority	NO
8	Equipment Rental	\$6,500.00	Equipment Purchase within Spending Authority	NO
9	Concrete Header Band	\$3,500.00	Procurement of Contractor Lowest Bidder	YES
10	Labor for Civil (Drainage)	\$7,500.00	Staff Resources	NO
11	Labor for Fence Installation	\$3,000.00	Staff Resources	NO
12	Labor for Earthwork	\$8,400.00	Staff Resources	NO
13	Survey	\$6,000.00	Engineer of Record	YES
Total Project Estimated Cost		\$94,600.00		



TOWN OF SURFSIDE

COMMUNICATIONS CONTRACTS

Public Information Representative Contract – Pinzur Communications

Monthly Fee: \$7,500.00

Potential Additional Fees: Annual SurveyMonkey subscription (\$408), printing of signs and materials as needed for community outreach campaigns (cost varies depending on number of signs, size, color, etc.)

Staff assigned to contract: Rachel Pinzur, 1 additional PIR staff member, videographer and graphic artist (all included in monthly fee)

Monthly Fee hours dedicated per month:

Under current contract, there is not a limit on hours. Prior to the coronavirus crisis, we routinely worked an average of 55 hours per week on Town of Surfside. This is all Pinzur Communications staff combined – often more on weeks with video production for Ch. 663. During crises, we have averaged 12 to 15 hours per day.

Responsible for: Provides support to all Town departments including police, and is responsible for communication to residents and press

Monthly Fee scope of work:

- Draft annual communications plan and strategy, as well as execute plan
- Draft key messages and FAQ documents as necessary
- Provide strategic PR counsel, as necessary, on matters of importance to Town residents
- Transform Channel 663 into a more lifestyle-focused channel that will appeal more to Surfside residents (note, most videos taken down for now as majority of focus of channel is coronavirus) Tasks include:
 - Create schedule that includes topic and segment ideas (i.e. Surfside 7, business district highlights, hurricane preparedness, events, important topics for residents, etc.)
 - Reach out to subjects, businesses, department directors, etc. to notify them in advance of filming

- Develop a TV training guide to help educate the interviewee about what to expect for filming, talking points, etc.
 - Schedule and film videos
 - Edit each video, which takes several days. Videos have unlimited use and can also be used for media opportunities
 - Upload videos to Channel 663 and make necessary edits/additions to content on Ch. 663 throughout the month
 - Develop slides for Ch. 663
- Implement public awareness campaigns (i.e. recycling workshop, government academy, Town resiliency measures, upcoming projects, etc.) as well as help boost citizen engagement
 - Monitor conversations being held about Surfside including Nextdoor for example to further direct communications strategy; draft content for each month and regularly post updates to keep residents informed of important information, events, etc.; respond to residents' public and private questions on platform, as well as via emails and SeeClickFix
 - Develop and design flyers and graphics for be used in various communication (i.e. community bulletin boards, Nextdoor, hands outs for residents, etc.)
 - Receive feedback from residents on preferred mode of communication in order to continually enhance communication – survey conducted a year ago; new survey going out next week
 - Assist with outreach to key stakeholders and the procurement of experts for partnerships
 - Continue to reach out to neighboring municipalities to form beneficial partnerships and share best practices
 - Produce Town e-blasts to ensure messages are consistent; continually keep residents engaged and informed of important information and updates; assist Police with emergency alerts to residents
 - Responsible for overseeing, drafting and/or editing any communication that goes to residents, such as door hangers, brochures, etc.
 - Draft press releases and media pitches; regularly works with press to provide information, photos and video needed
 - Regularly contributes to town gazette including town manager and mayor letters, articles, COVID crisis
 - Regularly add and manage information on the town website
 - Respond to resident concerns on SeeClickFix; work with various departments to research answers

IT Services Contract – CGA

Communications tasks only

- Monthly Fee:** \$2,280.00 (part of \$11,031.31 monthly IT retainer)
- Staff assigned to contract:** Adrian Santaella, Media Specialist Part Time dedicated to the Town of Surfside as needed for website updates.
- Potential Additional Fees:** \$238.29 per broadcasting event (Jose Feliz) – including setup, AV during meeting, posting after the meeting is over. Average Commission Meetings are 4 hours (30 min setup, 3-hour meeting, 30 min broadcasting of video)
- Monthly Fee hours dedicated per month:**
20 hours (Adrian Santaella)
- Monthly Fee Brief scope of work:**

Services provide by Adrian (part of overall IT retainer)

- Hosting the Town Website, ensuring Website ADA Compliance and up to 20 hours of Website posts and updates

Services provide by Jose (paid per meeting)

- Recording and Broadcasting all Public Meetings

Services provide by Jose (part of overall IT retainer)

- Closed Caption for Channel 663 and Video Streaming
- Keeping SCALA up to date (Town Broadcasting)

Production of Town Gazette Services Contract – Mediatech Miami, LLC

Monthly Fee: Up to \$5,800 (professional services, \$1,600; printing, \$3,800; mail processing fee, \$395). Gazette is approximately 16 pages.

Potential Additional Fees: Non-Gazette projects and programs are charged at \$85.00 per hour with a \$100 minimum. Potential additional services include: business cards; shuttle bus maps; standard envelopes; election publications, cards, folders; applications forms and flyers

Staff assigned to contract: Cory Gittner/Mediatech Miami, LLC.

Monthly Fee hours dedicated per month:

Estimated 20 hours for Gazette production at \$85.00 per hour (\$1,600)

Monthly Fee Brief scope of work: (All work overseen by staff)

- Graphic design for Gazette
- Gazette layout, including incorporation of external advertising
- Gazette proofs and revisions
- Gazette prepress and production, digital version
- Gazette Town mail list
- Printing and mailing management
- Photography at Town events and Commission meetings
- Select writing and AP Style editing on blurbs for the Gazette, most content is provided by staff across departments
- Additional services as described in 'Potential Additional Fees'



Services contracted for the Tourist Bureau have been funded by the Resort Tax and are overseen by the Tourist Board.

Marketing Services for the Tourist Bureau Contract – Jacober & Associates

Monthly Fee: Monthly retainer fee for 2nd year of three-year agreement is \$13,485.

Potential Additional Fees: Requests outside retainer scope of services. Overages for exceeding 93+ hours billed at \$145.00.

Staff assigned to contract: Dedicated Account Executive, Luisa Jimenez. Work performed by several members of Jacober Creative team.

Monthly Fee hours dedicated per month:

93 hours included in retainer.

Monthly Fee Brief scope of work: (All work overseen by staff)

- Visitor website www.visitsurfsidefl.com
- Website maintenance and content updates
- Editorial work including copywriting, dedicated blogs, advertorials
- Monthly newsletters and e-marketing
- Social media posts and strategy on Instagram, Facebook, Twitter
- All graphic design needs for tourism related content and special events like Third Thursdays, Paddletopia, First Fridays
- Calls and meetings with Surfside team
- Reports and Tourist Board updates
- Advertising strategy for social media and Google including media buys
- Ad creation

General Communications Information

www.TownofSurfsideFL.gov

- Platform
 - Sitefinity (<https://www.progress.com/sitefinity-cms>)
- Hosting Provider
 - CGA
- Design
 - Adrian Santaella (CGA)
- Content
 - Adrian Santaella (CGA) / Rachel Pinzur (Pinzur Communications) / Town Clerk, Parks and Req, Tourism, Police (Surfside)
- Web Support
 - Helpdesk <helpdesk@townofsurfsidefl.gov>

www.VisitSurfsideFL.com

- Platform
 - Django
- Hosting Provider
 - Jacober
- Design
 - Jacober Creative
- Content
 - Jacober Creative
- Web Support
 - Jacober Creative & Tourism Director

Internal Staff Communications Breakdown (excludes contractors).

- **Assistant Town Manager:** Designated staff member who oversees town website and public information. On the website front is supported by Project and Contract Manager and Tourism Director on weekly check in calls, project updates.
**COVID-19 Functioning Role: Position vacant. During COVID-19, overview duties related to Town website organization and content production have been assumed by a designated member of the Town Commission.*
- **Tourism Director:** External communications related to tourism, marketing services, international messaging. Also performs content updates to Town website. Manages business district list. Holds degree in Public Relations and Marketing.
**COVID-19 Functioning Role: Works as Emergency Communications Lead and serves on COVID-19 Task Force. Helps perform website updates. Hotels and Business District liaison. Part of Incident Command.*

- **Resiliency Officer:** Reviews and provides comment on communications related to sustainability and resiliency. Provides other communications support as directed.
**COVID-19 Functioning Role: Primary role is COVID-19 Task Force coordinator. Also assists with the following communications functions: helps identify information to share through Town communication channels; reviews COVID-19 content produced for eblasts, website and special Gazettes; occasionally drafts content if needed. Part of Incident Command.*

- **Project and Contract Manager:** Coordinates and oversees production of Town Gazette.
**COVID-19 Functioning Role: Serves on COVID-19 Task Force.*

ORDINANCE NO. 17 - _____

AN ORDINANCE OF THE TOWN COMMISSION OF THE TOWN OF SURFSIDE, FLORIDA AMENDING ARTICLE VI. - “RULES OF PROCEDURE FOR TOWN MEETINGS”; PROVIDING FOR SEVERABILITY; PROVIDING FOR INCLUSION IN THE CODE; PROVIDING FOR CONFLICTS AND PROVIDING FOR AN EFFECTIVE DATE.

1 **WHEREAS**, Section 20 of the Town of Surfside Charter provides that the Town Commission
2 of the Town of Surfside shall fix its rules of procedure; and

3 **WHEREAS**, the Town Commission adopted rules of procedure which have been
4 incorporated into Article, VI, Chapter 2 of the Town Code of Ordinances; and

5 **WHEREAS**, the Town Commission desires to amend Article VI. – “Rules of Procedure for
6 Town Meetings;” and

7 **WHEREAS**, the amendments to the ordinance do not conflict with the provisions in Section
8 2-151 Personnel Appeals Board Section, 2-185 Pension Board, Section 70-124 Resort Tax Board
9 or Sections 90-15, 90-16, 90-17, 90-18 of the Zoning Code for Planning and Zoning and Design
10 Review Board members; and

11 **WHEREAS**, the Town Commission held its first public reading on September 18, 2017 and
12 recommended approval of the proposed amendments to the Code of Ordinances having complied
13 with the notice requirements by the Florida Statutes; and

14
15 **WHEREAS**, the Town Commission has conducted a second duly noticed public hearing on
16 these regulations as required by law on October 10, 2017 and further finds the proposed change to
17 the Code necessary and in the best interest of the community.

18
19 **NOW, THEREFORE, BE IT ORDAINED BY THE TOWN COMMISSION OF THE**
20 **TOWN OF SURFSIDE, FLORIDA:**

21
22 **Section 1. Recitals.** The above Recitals are true and correct and are incorporated herein by
23 this reference:

24
25 **Section 2. Town Code Amended.** Article VI. – “Rules of Procedure for Town Meetings”
26 of the Surfside Town Code of Ordinances are hereby amended and shall read as follows¹:

27 **ARTICLE VI. - RULES OF PROCEDURE FOR TOWN MEETINGS**
28

¹Additions to the text are shown in underline. Deletions are shown in ~~strikethrough~~. Additions made after first reading are shown in double underline. Deletions made after first reading are shown in ~~double-strikethrough~~.

29 Sec. 2-201. - Rules of procedure for the town commission and town boards and committees.

30 *Rule 2.01 Governing rules; amendment.* Except as may be provided in the Charter, the
31 Town of Surfside Code, Florida laws or by these rules as set forth in this Article^{ordinance},
32 questions of order, the methods of organization and the conduct of business of the town
33 commission and town boards and committees and to the extent there is no conflict, the town
34 commission, and town boards and committees shall be governed by Robert's Rules of Order
35 ~~Mason's Manual of Legislative Procedure (2010 Edition)~~. Once enacted, and except as already
36 amended by the provisions contained herein, these rules may be amended by ~~two-thirds~~ majority
37 vote of the entire town commission.

38 Sec. 2-202. - Officers.

39 *Rule 3.01 Presiding officer.* The ~~mayor~~Mayor shall preside at all meetings of the town
40 commission at which he or she is present. In the absence of the ~~mayor~~Mayor, the vice
41 ~~mayor~~Mayor shall act as ~~mayor~~Mayor. In the absence of both the ~~mayor~~Mayor and vice
42 ~~mayor~~Mayor, the town commission shall select one of its members as a temporary presiding
43 officer. The presiding officer shall preserve strict order and decorum at all meetings of the
44 commission. A majority vote of the members present shall govern and conclusively determine all
45 questions of order not otherwise covered. The presiding officer has the power, among other
46 things, to recognize a speaker, secure and retain the floor for the speaker and keep order during
47 the time the floor is taken subject to Robert's ~~Mason's~~ Rules and to the rules contained in this
48 article.

49 *Rule 3.02 Clerk.* The town clerk shall act as clerk of the commission. The clerk of the
50 commission shall call the roll, prepare the minutes and shall be custodian of the records and shall
51 certify all ordinances and resolutions adopted by the commission, and perform such other duties
52 as required by the Town Charter.

53 *Rule 3.03 Town attorney.* The town attorney, or such member of the office of the town
54 attorney as may be designated, shall be available to the commission at all meetings: the town
55 attorney shall act as parliamentarian, and shall advise and assist the presiding officer in matters
56 of parliamentary law.

57 *Rule 3.04 Sergeant-at-arms.* The town police chief, or such other town official or employee
58 as the chief may designate, shall be the sergeant-at-arms of the town commission meeting, at the
59 request of the presiding officer or the town manager. The sergeant-at-arms shall carry out all
60 orders and instructions given by the presiding officer or the town manager for the purpose of
61 maintaining order and decorum at the meetings.

62 Sec. 2-203. - Meetings.

63 *Rule 4.01 Regular Meetings.*

64 (a) The commission shall hold regular meetings in accordance with its Charter or, if the Charter
65 provision is amended, in accordance with an ordinance duly adopted by the commission, as
66 may be amended from time to time.

- 67 (1) All regular and zoning meetings shall be held irrespective of whether or not any particular
 68 commission member (including the ~~Mayor~~Mayor) may be able to attend unless otherwise
 69 agreed by a majority of the commission. Such meetings shall be held in the commission
 70 chambers at 9293 Harding Avenue, Surfside, Florida 33154, or such location as may be
 71 approved by a majority of the commission members present and shall be open to the public
 72 and all news media.
- 73 (2) Regular meetings may be otherwise postponed or canceled by resolution or motion
 74 adopted at a regular meeting by a majority of the commission members present.
- 75 (3) No meeting shall continue beyond 11:00 p.m. unless there is an emergency, which is
 76 presented to the Commission, which is then followed with by a vote of the majority of the
 77 members of the commission present, the commission agrees to extend the meeting beyond
 78 this time.
- 79 (4) Workshops may be scheduled at the request of the Mayor, town manager, the town
 80 attorney or a majority of the commission at any time, provided appropriate notice is given.
- 81 (b) Zoning matters shall be scheduled as part of regular town commission meetings unless
 82 otherwise decided by the commission.
- 83 (c) The second reading (public hearing) of the annual budget ordinance or resolution shall be
 84 considered at a meeting at which the said budget ordinance or resolution and the levy of the
 85 millage are the only items on the agenda.

86 *Rule 4.02 Special meetings; emergency meetings.*

- 87 (1a) Special meetings. A special meeting of the commission may be called by the Mayor, a
 88 majority of the members of the ~~Mayor~~, town commission or the town manager. The clerk
 89 shall forthwith serve either verbal or written notice upon each member of the commission
 90 stating the date, hour and place of the meeting and the purpose for which such meeting is
 91 called; and no other business shall be transacted at that meeting, other than that described
 92 in the aforementioned notice. At least twenty-four (24) ~~hours notice~~ hour's notice must
 93 elapse between the time the clerk receives notice in writing and the time the meeting is to
 94 be held.
- 95 (2b) Emergency meetings. An emergency meeting of the town commission may be called by
 96 the Mayor, ~~mayor~~Mayor in accordance with prescriptions of the town charter whenever
 97 in his or her; opinion an emergency exists that requires immediate action by the
 98 commission. Whenever such emergency meeting is called, the ~~M~~Mayor shall
 99 notify the clerk who shall forthwith serve either verbal or written notice upon each
 100 member of the commission, stating the date, hour and place of the meeting and the
 101 purpose for which it is called, and no other business shall be transacted at that meeting,
 102 other than that described in the aforementioned notice. At least 24 hours shall elapse
 103 between the time the clerk receives notice of the meeting and the time the meeting is to
 104 be held.
- 105 (3e) If after reasonable diligence, it is impossible to give notice to each commissioner, such
 106 failure shall not affect the legality of the meeting if a quorum is present. The minutes of
 107 each special or emergency meeting shall show the manner and method by which notice of

108 such special or emergency meeting was given to each member of the commission, or shall
109 show a waiver of notice. All special or emergency meetings shall be open to the public
110 and shall be held and conducted in the Commission Chambers, Town Hall, 9293 Harding
111 Avenue, Surfside, Florida 33154, or other suitable location within the Town of Surfside,
112 Florida. Minutes thereof shall be kept by the town clerk.

113 (4d) No special or emergency meeting shall be held unless notice thereof is given in compliance
114 with the provisions of this rule, or notice thereof is waived by a majority of the entire
115 membership of the commission and in accordance with the town charter.

116 *Rule 4.03 Electronic files presented at public meetings.* Electronic files to be presented at
117 public meetings in the Town of Surfside must be provided to the town clerk by noon on the
118 business day prior to the scheduled meeting.

119 Sec. 2-204. – Boards, cCommittees, sub-committees and ad hoc committees.

120 *Rule 5.01 Boards, ccontinuing committees, sub-committees and ad hoc committees.* There
121 may be continuing committees, sub-committees and ad hoc committees of the town commission
122 created by resolution as the town commission deems necessary to conduct the business of the
123 town appropriately and in accordance with the town charter. Such committees and all Town
124 Boards to the extent these provisions do not conflict with other governing procedures or
125 requirements specific to a particular Board, shall be governed by these rules of procedure and
126 shall be subject to the Florida sunshine and public records laws. Each member of the town
127 commission shall appoint one (1) member to each committee. All appointments are at the will of
128 the appointing member of the town commission and may be removed at any time by the
129 appointing member of the town commission. Members of committees shall be appointed to serve
130 until the expiration of the committee or to the end of the appointing member of the town
131 commission's term.

132 (a+) *Continuing committees and sub-committee committees.* Continuing committees and sub-
133 committees shall exist until abolished by the town commission or shall have a sunset provision.

134 (b2) *Ad hoc committees.* The expiration date for each ad hoc committee shall be designated at the
135 time of formation, or the ad hoc committee shall expire when the ad hoc committee reports to
136 the commission that its designated goal or goals have been accomplished.

137 (c3) All continuing committees, sub-committees and ad hoc committees shall abide by the
138 following procedures:

139 (1)a- *Mission statement.* A mission statement shall be developed by the town commission.

140 (2)b- *Public meetings.* All meetings and business of any committee, sub-committee or ad
141 hoc committee shall comply with the Florida Statutes including that all committee
142 meetings shall be open to the public at all times, noticed, and minutes of the meetings shall
143 be taken and retained in the office of the town clerk. All committee members shall be
144 subject to the State of Florida, Miami-Dade County and Town of Surfside Conflict of
145 Interest and Code of Ethics Ordinance.

146 (3)e- *Agenda.* The committee chairperson shall prepare the agenda for the committee
147 meeting with the assistance of the committee staff liaison. ~~In the chairperson's absence,~~

148 ~~the vice chairperson shall prepare the agenda.~~ Any committee member may propose
149 additional agenda items at any time. Items proposed after the agenda is distributed may
150 only be heard under "New Business" and upon an affirmative vote of the majority of the
151 committee. Each agenda shall also include a section for public comment.

152 ~~(4)d.~~ *Public appearances and requests.* Any person may appear before any committee
153 during the public comment portion of the meeting.

154 ~~(5)e.~~ *Quorum.* A majority of the appointed members of the committee shall constitute a
155 quorum. ~~shall be 50 percent plus one of the committee members.~~ Provided there is a
156 quorum, a majority of those present and voting shall be required to adopt any motion or
157 take any action.

158 ~~(6)~~ *Failure to obtain a quorum.*

159 a. If, 48 hours prior to a regular meeting, the clerk has not received confirmation of
160 attendance from a sufficient number of committee members to constitute a quorum,
161 the meeting shall be canceled for lack of a quorum.

162 b. Should no quorum attend any meeting within 15 minutes after the hour appointed for
163 the meeting, the presiding member or the town clerk may adjourn the meeting. The
164 names of the members present at such meeting shall be recorded in the minutes.

165 ~~(7)f.~~ *Voting.* Each committee member shall be entitled to one vote. The committee shall act as
166 a body in making its decisions. No committee member present at a meeting may abstain
167 from voting unless the committee member possesses a conflict of interest, as provided in
168 either the Florida Statutes or the Miami-Dade County Code of Ethics and submits the
169 appropriate form to the town clerk.

170 ~~(8)g.~~ *Attendance.* In the event that a committee member fails to attend three regularly
171 scheduled meetings in any one calendar year, the committee member may be removed
172 from the committee and the town commission will be notified of the vacancy.

173 ~~(9)h.~~ *Appointments, vacancies and resignations.* Each person appointed to a committee,
174 sub-committee or ad hoc committee shall be appointed by the town commission in the
175 following manner:

176 ~~a1.~~ The ~~mayer~~ Mayor and each member of the town commission shall appoint one
177 member to each committee.

178 ~~b2.~~ Should any appointee resign or be removed during the term of the committee, sub-
179 committee or ad hoc committee, the appointing commissioner may select another
180 appointee in accordance with the procedure outlined as follows:

181 Upon notification of the vacancy of an at-large member, the town clerk shall notify
182 the town commission, or in the case of an individual appointment, the town
183 commissioner responsible for the appointment with a copy to the remainder of the
184 town commission, in writing. ~~The town commission shall establish a deadline for the~~
185 ~~submission of letters of interest to serve on the committee at a commission meeting.~~

186 ~~1.(i)~~ Any person who wishes to serve on a committee and who meets the qualifications
187 of office as set forth in this code and in the resolution creating or re-authorizing

188 the committee, shall submit his or her name and committee application available
189 from the town clerk or on the town website ~~together with a letter of interest~~ to the
190 town clerk ~~by the deadline established by the town commission~~. Thereafter, the
191 town clerk shall provide the appointing town commissioner or the entire town
192 commission, as applicable, with the names and submitted material(s) ~~letters of~~
193 interest.

194 2.(ii) Nominations and appointments to fill the vacancy shall be made at a town
195 commission meeting. Appointments to fill a mid-term vacancy shall only be
196 made for the remainder of the term of the committee member being replaced.

197 (10)i- *Reappointment.* Committee, sub-committee or ad hoc committee members shall be
198 eligible for reappointment and shall hold office until their successors have been duly
199 appointed and qualified.

200 (11)j- *Residency requirement.* Committee, sub-committee or ad hoc committee members
201 shall be registered qualified electors of Miami-Dade County, Florida, whose legal
202 residence is in the Town of Surfside.

203 (12)k- *Compensation.* All committee, sub-committee or ad hoc committee members shall
204 serve without compensation and shall not otherwise obtain direct or indirect financial gain
205 from their service on a committee.

206 (13)l- *Oath requirement.* All committee, sub-committee or ad hoc committee members
207 shall be required to subscribe to an oath or affirmation to be administered by and filed with
208 the town clerk, swearing to support, protect and defend the Constitution and laws of the
209 United States and of the State of Florida, the Charter and all ordinances of the Town of
210 Surfside and Miami-Dade County, and in all respects to faithfully discharge their duties.

211 (14)m- *Financial disclosure requirement/standards of conduct.* If required by law,
212 committee members shall file appropriate annual financial disclosure forms. All
213 committee members shall be subject to the standards of conduct for public officers and
214 employees set by federal, state, county or other applicable ethics or conflicts of interest
215 laws.

216 (15)n- *Officers and elections.* Except as provided otherwise in the resolution creating or re-
217 authorizing a committee, each committee shall elect a chairperson, and vice-chairperson
218 ~~and secretary~~ at the first committee meeting.

219 (16)o- *Records.* Minutes of all committee meetings shall be prepared by the town
220 administration and shall be available for public inspection. The minutes shall be forwarded
221 to each committee member for review and shall be approved by the committee at a public
222 meeting. Once approved, the meeting minutes shall be forwarded to the town clerk for
223 filing. ~~Attendance and absences must be recorded and submitted to the town clerk along~~
224 ~~with the minutes.~~ The ~~chair~~secretary of a committee, sub-committee or ad hoc committee,
225 working with the staff liaison, shall prepare a final report summarizing the committee's
226 activities, accomplishments, challenges and recommendations during the term. Such
227 report shall be presented for review and approval by the committee no later than the last
228 meeting of the term, and to be submitted to the town clerk for transmittal to the town

229 commission which shall be presented at the first a regular town commission meeting after
230 the election.

231

232 *Rule 5.02 Town commission liaison; appointment and definition.*

233 (a1) *Appointment:* The ~~mayer~~Mayor shall designate and appoint one member of the town
234 commission as the liaison to each board, committee and subcommittee of the town commission.

235 (b2) *Definition:* The town commission liaison is defined as a nonvoting member of a board,
236 committee or sub-committee who communicates the activities of the board, committee or
237 subcommittee to the town commission. The liaison's role is limited to responding to questions
238 posed by members of the board, committee or subcommittee to which the liaison serves. All
239 remarks from the liaison shall be addressed to the chair who serves as the presiding officer.

240 Sec. 2-205. - Conduct of meetings; agenda.

241 *Rule 6.01 Call to order.* Promptly at the hour set for each meeting, the ~~mayer~~Mayor and the
242 members of the town commission, the town attorney, the town manager and the town clerk shall
243 take their regular stations in the commission chambers. The presiding officer shall take the chair
244 and shall call the town commission to order immediately. In the absence of the presiding officer,
245 the town clerk shall then determine whether a quorum is present and in that event shall call for
246 the election of a temporary presiding officer. Upon the arrival of the presiding officer, the
247 temporary presiding officer shall relinquish the chair upon the conclusion of the business
248 immediately before the commission.

249 *Rule 6.02 Roll call.* The town clerk shall call the roll of the members, and the names of those
250 present shall be entered in the minutes. In the event the roll call reflects the absence of any
251 member on official town business that fact shall be noted in the minutes. Any town commissioner
252 who intends to be absent from town commission meeting shall notify the town clerk of the
253 intended absence as soon as convenient.

254 *Rule 6.03 Participation by physically absent member of the town commission; town board*
255 *or committee. ~~shall be permitted, but a town board or committee. -shall no bet permitted.~~ A*
256 *member of the town commission shall be permitted to participate and/or vote telephonically, by*
257 *virtual video or other electric means, provided that a physical quorum of the town commission is*
258 *present. A ~~but, a~~ town board or committee shall not be ~~is not~~ permitted to participate and/or vote*
259 *telephonically, by virtual video -and/or by interactive video.*

260 *Rule 6.04 Quorum.* A majority of the members of the town commission then in office shall
261 constitute a quorum. No ordinance, resolution or motion shall be adopted by the town commission
262 without the affirmative vote of the majority of all the members present.

263 *Rule 6.05 Failure to attain a quorum.* Should no quorum attend within 15 minutes after the
264 hour appointed for the meeting of the commission, the presiding officer or the town clerk may
265 adjourn the meeting. The names of the members present ~~and their action~~ at such meeting shall be
266 recorded in the minutes by the town clerk.

267 Rule 6.06 Agenda.

268 (a) *Order of business.* There shall be an official agenda for every meeting of the commission which
269 shall determine the order of business conducted at the meeting.

270 (1) The order of business shall be as follows:

271 ~~(a1)~~ order of business

272 a. call to order~~;~~

273 b. roll call of members,

274 c. pledge of allegiance,

275 d. agenda/order of business (additions/deletions),

276 e. special presentations,

277 (b) public comment on agenda items

278 ~~(b2)~~ quasi-judicial hearings

279 ~~(c3)~~ consent agenda at the pleasure of the commission, approval of minutes, town
280 manager, town attorney reports

281 ~~(d4)~~ ordinances,

282 ~~(e5)~~ resolutions

283 ~~(f6)~~ good and welfare shall be heard at a time certain at 8:15 p.m.

284 ~~(g7)~~ unfinished business and new business

285 ~~(h8)~~ ~~mayor~~Mayor, town commission and staff communications.

286 ~~(24)~~ Items shall be considered in the order in which they are placed on the agenda unless a
287 majority of the commissioners determines to deviate from the printed agenda.

288 ~~(3)~~ ~~The public may comment- comment on all -agenda items portion of the meeting. -shall be not be~~
289 ~~restricted to discussion on agenda items which are not scheduled for public hearing. Each speaker~~
290 ~~shall be given no more than three minutes to address the agenda speak and shall try to end on~~
291 ~~time as a courtesy to the residents and other participants wishing to also speak on the item. ,~~
292 ~~unless by vote of a majority of the members of the commission present, it is agreed to extend the~~
293 ~~time frames.~~

294 ~~(32)~~ The good and welfare portion of the agenda set for 8:15 p.m. ~~-shall provide for public~~
295 ~~comment on any items related to Town business or any matter within the scope of the~~
296 ~~jurisdiction of the town commission, whether or not included on the agenda for the~~
297 ~~meeting. shall be restricted to discussion on subjects not already specifically scheduled~~
298 ~~on the agenda. In no event shall this portion of the agenda be allotted more than 45 minutes~~
299 ~~with each speaker to be given no more than three minutes, unless by vote of a majority of~~
300 ~~the members of the commission present, it is agreed to extend the time frames. Likewise,~~
301 ~~members of the town commission shall be restricted to speaking three minutes each unless~~
302 ~~an extension is granted in the same manner as set forth in the prior sentence. The rules of~~

303 section 2-207(e) as set forth hereinbelow shall be observed during this portion of the
304 agenda.

305 (43) The town commission shall not take action upon any matter, proposal, or item of business
306 which is not listed upon the official agenda, unless it is approved at the meeting by a
307 majority of the entire commission, which shall have first consented to the matter for
308 consideration. No ordinance, resolution or other matter listed on the agenda for public
309 hearing, or the vote thereon, may be deferred until a later time unless a majority of the
310 entire town commission shall vote in favor of such deferral.

311 (b) ~~Authority to p~~Placing items on agenda.

312 ~~(12) Ordinances, Resolutions and O~~Ordinances may be prepared and scheduled on the agenda
313 at the direction of the town commission, a town commissioner with the support of the
314 majority of the commissioners present at a town commission meeting, or by Mayor, the
315 town manager, town attorney or town clerk.

316 ~~(21) All other matters.~~ Matters, other than ~~resolutions or~~ ordinances, may be placed on the
317 agenda by any member of the town commission, the town manager, the town attorney and
318 the town clerk. ~~Members of the town commission may, at a town commission meeting,~~
319 ~~direct the town manager or the town attorney to prepare an resolution or ordinance for~~
320 ~~placement on the agenda for the following agenda.~~

321 ~~(32)Deadline.~~ In no event may any town commissioner place an item on an agenda unless all
322 materials for the item are provided to the town clerk by 12:00 noon seven working days
323 prior to the meeting date unless approved by the Town Manager. Any complete item
324 provided after 12:00 noon seven working days prior to the meeting date shall be
325 distributed to the commission with a "7-day cover memo" and shall be added to the agenda
326 only if a majority of the commissioners present consent to the addition of the item to the
327 agenda.

328 (c) *Approval of minutes.* All minutes shall be summary in nature. A copy of such completed
329 minutes shall be placed on a regular agenda and may only be approved by a majority of the
330 members of the town commission, and upon such approval shall become the official minutes.

331 *Rule 6.07 Ordinances, resolutions, motions, contracts.*

332 (a) *Preparation and enactment of ordinances.* The town attorney shall prepare ordinances and
333 resolutions. Ordinances may be introduced, listed by title and shall be read by title only before
334 consideration by the town commission on first reading. At public hearing, each ordinance shall
335 be voted on individually by a call of the roll. Only resolutions and motions may be enacted by
336 voice vote calling for "ayes" or "no" on the question.

337 (b) *Approval by town attorney.* All ordinances, resolutions and contract documents, before
338 presentation to the town commission, shall have been reduced to writing and reviewed for form
339 and legality by the town attorney. Ordinances, resolutions and contract documents, in their
340 final form as approved by the Town Commission shall be have been approved as to form and
341 legality by the town attorney prior to execution.

342 (c) *Introduction and sponsorship.* Ordinances, resolutions and other matters and subjects requiring
343 action by the town commission may be introduced and sponsored by the ~~mayor~~Mayor or any
344 member of the town commission, ~~except that either the~~ The town manager, the town attorney or
345 town clerk may present ordinances, resolutions and other matters or subjects to the town
346 commission for consideration, and any commissioner may assume sponsorship thereof by
347 moving that such ordinance, resolution, matter or subject be adopted in accordance with law;
348 otherwise they shall not be considered.

349 (d) *Sunset.* There is no requirement for any ordinance to contain a sunset provision.

350 (e) *Zoning exception.* The provisions of this Rule 6.06 shall not be applicable to zoning resolutions
351 which shall be governed exclusively by the Zoning Code.

352 ~~(f) *No commission jurisdiction.* Prior to the commission's considering any resolution over which
353 the commission does not have substantive jurisdiction, including resolutions expressing the
354 commission's intent or opinion, a preliminary vote shall be taken to determine whether it is
355 appropriate for the commission to consider such resolution. Unless the commission, by a two-
356 thirds vote of the members present, agrees to consider the resolution, the resolution shall be
357 deemed to have failed. If the commission agrees to consider the resolution, the resolution shall
358 be heard after all other resolutions sponsored by commissioners have been addressed by the
359 commission. If the commission decides to discuss such resolution, the resolution shall require
360 a two-thirds affirmative vote of the commissioners present in order to be passed. The provisions
361 of this ordinance shall not apply to resolutions relating to state or federal legislative priorities.~~

362 *Rule 6.08 Statement of fiscal impact required for ordinances; exceptions.* Prior to the second
363 reading of any ordinance, the town manager shall prepare a written statement setting forth the
364 fiscal impact, if any, of the proposed ordinance. No ordinance shall be considered on second
365 reading if the statement of fiscal impact is not submitted with the ordinance as part of the agenda.
366 The provisions of this rule shall not apply to any emergency ordinance or any budget ordinance
367 or resolution.

368 *Rule 6.09 Limitation on agenda items.* No commissioner shall sponsor or cosponsor a total
369 of more than three ordinances for first reading and three resolutions at any commission meeting.
370 This provision shall not be applied to ordinances or resolutions which are intended to correct
371 scrivener's errors.

372 Sec. 2-206. - Public participation.

373 *Rule 7.01 Persons authorized on the dais.* No person, except town officers or their
374 representatives, shall be permitted on the dais unless authorized by the presiding officer or a
375 majority of the town commission.

376 *Rule 7.02. Citizens presentations; public hearings.*

377 (a) *Citizens' presentations.* Any citizen ~~may request may request shall be entitled shall be entitled~~
378 to be placed on the official agenda of a regular meeting of the town commission and be heard
379 concerning any matter within the scope of the jurisdiction of the town commission ~~outside of~~
380 Good and Welfare. Only members of the town commission and the town manager may place
381 a citizen on the official agenda.

382 (b) *Public hearings.* Any citizen shall be entitled to speak on any matter appearing on the official
383 agenda under the section "public hearings."

384 (c) *Public discussion on agenda items.* ~~No citizen shall be entitled~~Citizens shall be permitted to
385 address the town commission on any matter listed on or added to the official agenda which is
386 not scheduled for public hearing, discussion or debate. ~~except during Public Comment on~~
387 ~~Agenda Items unless the item is opened for public comment and the speaker recognized by the~~
388 ~~Chair~~Good and Welfare. When the town commission considers an agenda item that is open for
389 public hearing, discussion or debate that is not a public hearing and on which the public
390 comment is either unanimously in favor or unanimously against the item's passage, input from
391 members of the public shall be limited to no more than three minutes on any given item, unless
392 an extension is granted by a majority of the members of the town commission.

393 *Rule 7.03 Registration of speakers.*

394 (a) Registration of speakers ~~shall be required~~ shall be encouraged. The town clerk shall prepare
395 appropriate registration cards. The cards shall include a place for the speaker to provide his/her
396 name, address, lobbyist registration status which may be verified by the town clerk prior to
397 speaking, and the agenda item on which he or she is speaking ~~if registration is required on a~~
398 ~~particular agenda item.~~

399 (b) For any single agenda item, and except for zoning, no more than one-half hour per side shall
400 be allocated to speakers from the public. The presiding officer shall limit the time of each
401 individual speaker in order to insure compliance with this rule.

402 *Rule 7.04 Addressing commission, manner, time.* Each person, other than ~~salaried~~ members
403 of the town staff, who addresses the town commission shall step up to a podium and shall give
404 the following information in an audible tone of voice for the minutes:

405 (a) Name;

406 (b) Address;

407 (c) Whether the person speaks on his or her own behalf, a group of persons, or a third party; if the
408 person represents an organization, the person shall also indicate the number of members in the
409 organization, the annual dues paid by the members, the date of the most recent meeting of the
410 organization's board or governing council, and whether the view expressed by the speaker
411 represents an established policy of the organization approved by the board or governing
412 council, if requested; if the person is speaking on behalf of a group, s/he shall be required to
413 register as a lobbyist if required by that ordinance and shall state for the record: (i)
414 Compensation, if any, (ii) whether the person or any immediate family member has a personal
415 financial interest in the pending matter, other than as set forth in (i) if requested.

416 Unless further time is granted by the town commission and with the sole exception of zoning items
417 which shall not have a prescribed time limit unless imposed by the chair in accordance with the
418 advice of the town attorney, the statement shall be limited to the times prescribed herein. All
419 remarks shall be addressed to the town commission as a body and not to any member thereof. No
420 person, other than the ~~mayor~~Mayor, members of the town commission and the person having the
421 floor shall be permitted to enter into any discussion, either directly or through a member of the

422 commission, without the permission of the presiding officer. No question shall be asked of any
423 member of the town commission except through the presiding officer.

424 *Rule 7.05 Decorum.* Any person making ~~impertinent or~~ slanderous remarks ~~or who becomes~~
425 ~~boisterous~~ while addressing the town commission shall be warned. If after the warning, the
426 behavior continues, —said person shall be barred from further appearance before the town
427 commission by the presiding officer for the duration of the meeting, unless permission to continue
428 or again address the town commission is granted by the majority vote of the town commission
429 members present. ~~No clapping, applauding, h~~Heckling or verbal outbursts in support or
430 opposition to a speaker or his or her remarks shall not be permitted. ~~Signs or placards may be~~
431 ~~disallowed in the town commission chambers by the presiding officer. Persons exiting the town~~
432 ~~commission chambers shall do so quietly.~~

433 Sec. 2-207. - Rules of debate.

434 *Rule 8.01 Rules of debate.*

435 (a) *Questions under consideration.* When a motion is presented and seconded, it is under
436 consideration and no other motion shall be received thereafter, except to adjourn, to lay on the
437 table, to postpone, or to amend until the question is decided. These motions shall have
438 preference in the order in which they are mentioned. A motion to adjourn and a motion to lay
439 on the table shall be decided without debate. Final action upon a pending motion may be
440 deferred until a date certain by a majority of the members present.

441 (b) *As to the presiding officer.* The ~~mayor~~Mayor, as presiding officer, may vote on but shall not
442 move or second an item of debate. The presiding officer, however, upon relinquishing the chair,
443 may move or second an item, ~~vote~~, subject only to such limitations as are by these rules
444 imposed upon all members.

445 (c) *Getting the floor, improper references to be avoided.* Every member desiring to speak for any
446 purpose shall address the presiding officer, ~~and~~ upon recognition, ~~shall be confined to the~~
447 ~~question under debate avoiding all personalities and indecorous language.~~

448 (d) *Interruption; call to order; appeal a ruling of the chair.* A member once recognized shall not
449 be interrupted when speaking unless it is a call to order or as herein otherwise provided. If a
450 member be called to order, the member shall cease speaking until the question of order is
451 determined by the presiding officer, and if in order, the member shall be permitted to proceed.
452 Any member may appeal to the town commission from the decision of the presiding officer
453 upon a question of order when, without debate, the presiding officer shall submit to the town
454 commission the question, "Shall the decision of the chair be sustained?" and the town
455 commission shall decide by a majority vote.

456 (e) *Time limit for Consent agenda debate.* The presiding officer shall open for public comment on
457 any items on the consent agenda, prior to commission consideration of the consent agenda.
458 There shall be no dDebate on any motion pertaining to an item on the consent agenda, however,
459 any member of the town commission may pull an item from the consent agenda for
460 consideration shall be limited to three minutes. After three minutes of debate the item shall be
461 removed from the consent agenda, if any, and placed on the regular town commission agenda.

462 ~~The discussion by the town commission on any one item shall not exceed one half hour or~~
463 ~~unless an extension is granted by a majority of votes of the town commission.~~

464 (f) *Privilege of closing debate.* Any town commission member (including the presiding officer)
465 shall have the privilege of closing the debate by making a motion to that effect and provided it
466 is affirmed by vote of a majority of the town commission present.

467 (g) *Method of voting.* After the debate is closed, and/or the motion is restated if necessary, the
468 presiding officer shall call for a vote on the motion. Voting shall be by roll call or voice vote,
469 or paper ballot (at the decision of the majority of the commission in certain circumstances)
470 depending on whether the ballot is on an ordinance or resolution or motion. Ordinances require
471 a roll call vote by calling the names of the members of the town commission in rotating order,
472 provided that the ~~V~~ice-mayorMayor shall vote next to last and alphabetically by surname,
473 except that the names shall be rotated after each roll call vote, if requested, so that the
474 commissioner who voted first on a preceding roll call shall vote last upon the next subsequent
475 matter; provided, however, that the presiding officer, if a member of the town commission,
476 shall always cast the last vote.

477 The town clerk shall call the roll, tabulate the votes, and announce the results. The vote upon
478 any resolution, motion or other matter may be by voice vote as previously noted, provided that
479 the presiding officer or any commissioner may require a roll call to be taken upon any
480 resolution or motion.

481 (h) *Explanation of vote; conflicts of interest.* There shall be no discussion by any town
482 commissioner voting, and the town commissioner shall vote yes or no. Any town
483 commissioner, upon voting, may give a brief statement to explain his or her vote. A town
484 commissioner shall have the privilege of filing with the clerk a written explanation of his or
485 her vote. Any town commissioner with a conflict of interest on a particular matter shall refrain
486 from voting or otherwise participating in the proceedings related to that matter and must leave
487 the commission chambers until the consideration of that matter is concluded and file the proper
488 form with the town clerk.

489 (i) *Tie votes.* Whenever action cannot be taken because the vote of the town commissioners has
490 resulted in a tie, the status quo shall continue in effect and the proposed ordinance, resolution
491 or motion that produced the tie vote shall be removed from the agenda without prejudice to its
492 reintroduction on a de novo basis at a later time, ~~provided that in zoning and other quasi-~~
493 ~~judicial matters when action on a resolution results in a tie vote, such resolution matter shall~~
494 ~~be carried over to the next regularly scheduled meeting for the consideration of such quasi-~~
495 ~~judicial matters unless the town commission designates a different time for such~~
496 ~~reconsideration.~~

497 (j) *Vote change.* Any town commissioner may change his or her vote before the next item is called
498 for consideration, or before a recess or adjournment is called, whichever occurs first, but not
499 thereafter. In this case, the town clerk shall call back the vote and verify the outcome for the
500 presiding officer.

501 (k) *No motion or second.* If an agenda item fails to receive a motion or second, it shall be removed
502 from the agenda and shall be reintroduced only in accordance with the renewal provisions of
503 Rule 8.01(m).

504 (l) *Reconsideration.* An action of the town commission may be reconsidered only at the same
505 meeting at which the action was taken, or, if not, at the next meeting thereafter a motion to
506 reconsider may be made only by a town commissioner who voted on the prevailing side of the
507 question and must be concurred in by a majority of those present at the meeting. ~~A motion to~~
508 ~~reconsider shall not be considered unless at least the same number of town commissioners is~~
509 ~~present as participated in the original vote, or upon affirmative vote of two thirds of those~~
510 ~~commissioners present.~~ Adoption of a motion to reconsider shall rescind the action
511 reconsidered.

512 (m) *Renewal.* Once action is taken on a proposed ordinance or resolution neither the same matter
513 nor its repeal or rescission may be brought before the town commission again for a three-month
514 period following the said action unless application for renewal by three commissioners is first
515 submitted to the presiding officer. Should an ordinance or resolution be proposed that raises
516 the same previously resolved matter, or its repeal or rescission, in different or modified form
517 during the three-month period, the presiding officer may declare the proposal out of order.

518 (n) *Adjournment.* A motion to adjourn shall always be in order and decided without debate.

519 (o) *Suspension of the rules.* No rule of procedure adopted by the town commission shall be
520 suspended except by an affirmative vote of a majority two-thirds of the members of the town
521 commission present.

522 Sec. 2-208. - Additional ordinances prescribing town commission procedure.

523 ~~Rule 9.01 Representation of Town of Surfside. Whenever~~ The presiding officer town
524 commission may, with the consent of the designee, designate a member(s) of the town
525 commission to represent the town commission at such meetings, conferences or other occasions
526 as deemed ~~deems it necessary or desirable that~~ by the town commission, shall be represented at
527 ~~meetings, conferences or other occasions involving other governmental entities, agencies,~~
528 ~~officials or groups, or non-governmental organizations, or departments, agencies or officials of~~
529 ~~the town government, the presiding officer may designate members of the town commission to~~
530 ~~represent the town commission at such meetings, conferences or other occasions, with the consent~~
531 ~~of the designee.~~ A designation must be ratified by a majority of the members of the town
532 commission then present ~~may disapprove any such appointment.~~ Such representative(s) shall have
533 no power to act for or on behalf of the town commission, or to make any commitment or binding
534 obligation on behalf of the town commission or the town. Such representatives shall report to the
535 town commission with regard to such meeting, conference or other occasion.

536 *Rule 9.02 Noncompliance with procedural rules.* If a procedural rule pursuant to this Article
537 VI. — "Rules of Procedure for Town Meetings" is not complied with as a result of either mistake,
538 inadvertence or excusable neglect, as those terms are defined by law, by either the presiding
539 officer or the parliamentarian, then the validity of the underlying substantive ordinance,
540 resolution, motion or other action shall in no way be affected thereby, and the failure of
541 compliance with said procedural rule shall not be the basis for any person or party to challenge
542 any ordinance, resolution or other action.

543 Sec. 2-209. - Amendment to rules of procedure for town meetings.

544 Once adopted, changes to these rules may be made as changes to any other ordinance are
545 made by a majority vote and after two readings of the amendatory ordinance.

546 Secs. 2-210—2-225. - Reserved.

547 **Section 3. Severability.** If any section, sentence, clause or phrase of this ordinance is held
548 to be invalid or unconstitutional by any court of competent jurisdiction, then said holding shall in
549 no way affect the validity of the remaining portions of this ordinance.

550 **Section 4. Inclusion in the Code.** It is the intention of the Town Commission, and it is hereby
551 ordained that the provisions of this Ordinance shall become and made a part of the Town of Surfside
552 Code of Ordinances, that the sections of this Ordinance may be renumbered or re-lettered to
553 accomplish such intentions; and the word “Ordinance” may be changed to “Section” or other
554 appropriate word.

555
556 **Section 5. Conflicts.** Any and all Ordinances and Resolutions or parts of Ordinances or
557 Resolutions in conflict herewith are hereby repealed.

558
559 **Section 6. Effective Date.** This ordinance shall become effective upon adoption.

560
561 **PASSED and ADOPTED** on first reading this 18th day of September, 2017.

562
563 **PASSED and ADOPTED** on second reading this 10th day of October, 2017.

564
565
566 On Final Reading Moved by: _____

567
568 On Final Reading Second by: _____

569
570
571 **FINAL VOTE ON ADOPTION:**

572 Commissioner Daniel Gielchinsky _____

573 Commissioner Michael Karukin _____

574 Commissioner Tina Paul _____

575 Vice ~~Mayor~~Mayor Barry Cohen _____

576 ~~Mayor~~Mayor Daniel Dietch _____

577
578
579
580 _____
Daniel Dietch, ~~Mayor~~Mayor

581
582 **ATTEST:**

583

584 _____
585 Sandra Novoa, MMC, Town Clerk

586 **APPROVED AS TO FORM AND LEGALITY FOR THE USE**
587 **AND BENEFIT OF THE TOWN OF SURFSIDE ONLY:**

589 _____
590 Weiss Serota Helfman Cole and Bierman, P.A.
591 Town Attorney
592



**Town of Surfside
Town Commission Meeting**

Town Hall Commission Chambers - 9293 Harding Ave, 2nd Floor
Surfside, FL 33154

DISCUSSION ITEM MEMORANDUM

Agenda #:

Date: May 12, 2020

From: Mayor Charles W. Burkett

Subject: Proposed Charter Amendment

On Tuesday, May 12, 2020, Surfside can take another bold step towards halting the over-development that was inflicted upon on our Town by the former Mayor and most of his Commission allies over the last 10 years.

Your new Commission took the brave step at the last meeting to initiate the process to throw out the entire developer approved code now in use. It also voted to return Surfside to the 2004 code that was in place at the time 92% of residents voted to enshrine strict development restrictions into our Charter – Surfside’s version of the U.S.’s Constitution.

Over the last 10 years, starting in 2010, after I lost that election, Mr. Dietch and his allies went to work systematically changing the zoning laws, which allow builders free reign in the Collins / Harding district and elsewhere in our Town.

They even went so far as to gut our 2004 Charter amendment – the one designed to protect against the types of changes in the zoning code that Mr. Deitch and his allies would make in the zoning code over the last 10 years.

The next part of the story will get a little into the weeds, however it will show HOW, Mr. Dietch and his over-development allies, seized the power back from the residents to control development in Surfside by CHANGING the Charter.

In my opinion, what you’re going to read now is really the most shocking part of the entire scheme.

In a breath-takingly deceptive and dishonest move, Mr. Dietch and his over-development allies, put forward a ballot question titled “RESTRICTION ON DEVELOPMENT”.

Not only were the contents of the proposed ballot question NOT restrictive, they catastrophically eviscerated the protections that had been written into the document.

Residents were understandably completely hoodwinked by the flowery language in the question that appeared on the ballot.

For instance, ask yourself these questions after reading the ballot question (attached) over a few times:

- a) What part of the question/statement contains restrictions? Answer: none.
- b) What is being reinforced? Answer: nothing.
- c) What is being clarified? Answer: nothing, however there's a whole lot being changed.

If you're wondering - like I was, what any of the ballot language really means, you'd have to look to the next (2nd attachment) which was the actual 'before and after' language in our Charter.

The words with lines under them are additions by Dietch and Company, and the words with lines through them, conversely were removed by Dietch and Company.

You can now see that NONE of the changes were "reinforcements" or "clarifications."

The changes were simply – changes - put in place to give developers the zoning code they needed to begin to turn Surfside into Sunny Isles or Miami Beach.

For instance:

The term "units per acre" replaced the term "floor areas."
"Maximum allowable floor area ratios" were stricken.
"Building heights" were redefined and,
Language pointing to the amendment being approved by Surfside voters was stripped out.

Does any of the foregoing sound like MORE "restrictions on development", the title of the ballot question? It is not!

Or does it sound to you, like it sounds to me? – A fraud perpetrated on the voters of Surfside, grossly misleading them with a deceptive ballot question, so elected officials could accommodate their developer friends by undoing and rewriting our protective zoning code.

Thursday, we have a chance to begin to unwind all of the unsavory and manipulative actions that were taken by the former Mayor and his over-development allies and I hope you'll join us to make it happen.

I want to address those who will say, let's just fix the current code and not go back to the old code by saying, it's not possible.

The reason the “new” zoning code was voted in was because it was newly written from start to finish, top to bottom – and for a very specific reason which we all are now seeing around us.

In a nutshell, the old code allowed small buildings on small lots and big ones on big lots. It regulated uses in our small Town to areas that supported those uses. It limited heights, size & many other important metrics.

The Dietch and his over-development allies zoning code now in place, initially put forward in 2010, has allowed developers to build bigger, higher and denser and is now so riddled with goodies, added by Mr. Dietch and his over-development allies over the last 10 years, that it needs to be thrown out, just as our old code was.

Yes, our old code may need some updates and tweaks before it's perfect for 2020, and I'm very sure our new Commission is committed to supporting each one of those, but the point is, it's better to fix a code that was written and put into place by those who cared for and wanted to protect residents from over development, rather than to try to fix an entire code that was sanctioned and put into place by those whose objective it was to turn our Town into Sunny Isles or Miami Beach!

See you Tuesday, May 12th at 7pm.



MEMORANDUM

To: Guillermo Olmedillo, Town Manager

From: Alan P. Graham, Code Compliance Director

Date: April 24, 2020

Subject: April 28, 2020 Special Town Commission Meeting
Discussion Item W, Regulation of Short-Term Rentals

Town Code Sections 90-41.1 provides the regulations for short-term rentals. The current code requires property owners to register with the Town all seasonal, short-term guests and to pay an appropriate registration fee and resort tax (4%).

The Code also limits a property owner to having three (3) short-term rentals over a twelve-month time period.

When a Code Compliance Officer becomes aware of a property that is rented on a short-term basis but did not register or pay the required fees, then the Officer sends out an invoice to the property owner for the monetary amount due. If the property owner does not remit to the Town the amount due, then Officer issues to the property owner a Civil Violation Ticket that carries a civil fine.

If the Town Commission wants to change any portion of this particular Town Code, then we would need to bring an Amended Ordinance before the Town Commission.

If you have any questions, then please contact me at (305) 861-4863 ext. 230.

cc: Lillian Arango, Town Attorney
Jason D. Greene, Finance Director
Sandra Novoa, Town Clerk



February 17, 2017

Town of Surfside
3293 Harding Ave
Surfside, FL 33154

Tel: (305) 777-2190

Attn: Randy Stokes
Public Works Director

Star Cleaning USA, Inc sweeping rate for the Town of Surfside will increase to \$33.40 per mile, effective from March 1st, 2017. The scope of service includes mechanical sweeping of the 25 miles of the Town of Surfside with a frequency of two times a month.

Note: All payment must be received within thirty (30) days after the invoice date.

* No taxes will be applied to this service.

Cancellation notice must be received 30 days in advance.

Respectfully,

Approved by:

Michael Gonzalez
Operations Manager
Star Cleaning U.S.A, Inc.

A handwritten signature in blue ink that reads "Randy Stokes". The signature is written over a horizontal line.

**BID BLANK
STATE JOB**

Let by: District 1 - Bartow

Star Cleaning USA, Inc.

(Void if used by any bidder other than one this Form issued to)

FINANCIAL PROJECT NO(S): 429423-1-72-01

ROAD(S) NO(S): On the primary

This project is let under the authority of Chapter 337, F.S.

CONTRACT NO.: E1K83-R0

CONTRACT CALENDAR DAYS: 365

DATE BIDS DUE: January 19, 2012

TOTAL AMOUNT:

DATE OF AWARD: February 13, 2012

\$ 20,607.50

DATE OF CONTRACT
EXECUTION: March 7, 2012

8.60 % DBE Availability



PROPOSAL

To Accompany
THE STANDARD SPECIFICATIONS AS AMENDED BY THE SPECIFICATIONS PACKAGE AND
ANY SUPPLEMENTAL SPECIFICATIONS PACKAGES, AND THE PLANS.

FOR ABOVE PROJECT(S)

The Improvements under this Contract consist of Mechanical Sweeping of Bridges, Curbs and Gutters

in Hardee, Desoto, Manatee, & Sarasota County(ies)

NOTE: Attach your Proposal Guaranty to this bid blank. All Extensions must be carried out. Any changes made in unit bid prices must be initialed by bidder.

P O S T I N G N O T I C E

UNLESS OTHERWISE NOTIFIED BY CERTIFIED MAIL, EXPRESS DELIVERY, HAND DELIVERY, FAX OR EMAIL RETURN RECEIPT, THE SUMMARY OF BIDS WILL BE POSTED AT THE DISTRICT CONTRACTS ADMINISTRATION WEB SITE <http://www.dot.state.fl.us/contractsadministrationdistrict1/>, AND SELECT LETTING DATE FROM THE DISTRICT 1 LETTINGS MENU, ON **FEBRUARY 7, 2012** OR IN THE ALTERNATIVE **FEBRUARY 14, 2012**. ADDITIONALLY A HARD COPY WILL BE POSTED ON THE FIRST FLOOR LOBBY OF THE DISTRICT ONE HEADQUARTERS BUILDING, FLORIDA DEPARTMENT OF TRANSPORTATION DISTRICT OFFICE COMPLEX, 801 NORTH BROADWAY AVENUE, BARTOW, FLORIDA 33830, AND WILL REMAIN POSTED FOR A PERIOD OF SEVENTY-TWO (72) HOURS. BY CALLING (863) 519-2559, DURING EACH POSTING PERIOD, INFORMATION CONCERNING THE POSTED PROJECTS CAN BE OBTAINED. THE POSTING PROVIDES NOTICE OF THE DEPARTMENT'S INTENT TO AWARD A CONTRACT OR REJECT ALL BIDS. THE DEPARTMENT'S NOTICE OF INTENT REGARDING A PROJECT WILL BE POSTED ON ONLY ONE OF THE ALTERNATE POSTING DATES. BIDDERS ARE SOLELY RESPONSIBLE FOR TIMELY MONITORING OR OTHERWISE VERIFYING ON WHICH OF THE SPECIFIED ALTERNATE POSTING DATES THE POSTING OF AWARD OR REJECTION OF ALL BIDS ACTUALLY OCCURS.

ANY PERSON ADVERSELY AFFECTED BY THE DEPARTMENT'S INTENDED DECISION TO AWARD A CONTRACT OR TO REJECT ALL BIDS SHALL FILE WITH THE CLERK OF AGENCY PROCEEDINGS, FLORIDA DEPARTMENT OF TRANSPORTATION, 605 SUWANNEE STREET, ROOM 562, TALLAHASSEE, FLORIDA 32399-0458, A NOTICE OF PROTEST, AND BOND WITHIN 72 HOURS OF POSTING OF THE SUMMARY OF BIDS. IF NOTICE OF INTENDED DECISION IS GIVEN BY CERTIFIED MAIL OR EXPRESS DELIVERY, THE ADVERSELY AFFECTED PERSON MUST FILE THE NOTICE OF PROTEST AND BOND WITHIN 72 HOURS AFTER RECEIPT OF THE NOTICE OF INTENT. A FORMAL WRITTEN PROTEST MUST BE FILED WITHIN TEN DAYS AFTER FILING THE NOTICE OF PROTEST. THE FORMAL WRITTEN PROTEST SHALL STATE WITH PARTICULARITY THE FACTS AND LAW UPON WHICH THE PROTEST IS BASED. IN ACCORDANCE WITH SECTION 120.57(3), FLORIDA STATUTES, FAILURE TO FILE A PROTEST WITHIN THE TIME PRESCRIBED IN SECTION 120.57(3), FLORIDA STATUTES, SHALL CONSTITUTE A WAIVER OF PROCEEDINGS UNDER CHAPTER 120, FLORIDA STATUTES.

IF THE POSTING DATES ARE REVISED, ALL BIDDERS FOR THE SUBJECT PROJECT WILL BE NOTIFIED OF THE DEPARTMENT'S INTENDED DECISION. BIDDERS MUST ACKNOWLEDGE RECEIPT OF THE NOTICE OF THE REVISED DATE.

BID SOLICITATION NOTICE - District 1
FLORIDA DEPARTMENT OF TRANSPORTATION
CONSTRUCTION AND MAINTENANCE PROGRAMS

Bartow, Florida
December 20, 2011
Advertisement No. 1

Bids for construction projects listed in this Bid Solicitation Notice with a budget of \$5 million or more must be submitted using Bid Express only. No other means of submission of bids will be accepted. Please visit the Contracts Administration Website at: <http://www.dot.state.fl.us/cc-admin> for more information on Bid Express.

Unless otherwise instructed, bids for construction projects with a budget of less than \$5 million and all maintenance projects listed in this Bid Solicitation Notice can be submitted using Bid Express or can be submitted at any of the following Florida Department of Transportation location(s) until 2:00 PM Local Time on **Thursday, January 19, 2012**. To obtain a Digital ID please contact Bid Express at <http://www.bidx.com>. Allow up to 6 days to complete the Digital ID registration.

Location	Address	Room Number
District 1	801 N. Broadway Bartow, Florida 33830	Procurement Services Conference Room

The sealed bids received in the above referenced location(s) will be publicly opened and the Bid totals for each bid submitted will be read aloud at 2:30 PM **January 19, 2012** in the Procurement Services Conference Room, Bartow, Florida. Anyone needing special accommodations under the Americans with Disabilities Act of 1990 should send an e-mail to: contracts.admin@dot.state.fl.us or call telephone number (863) 519-2559. Special accommodation requests under the Americans with Disabilities Act should be made at least seven days prior to the public meeting. If the budget amount is greater than \$250,000.00 on construction projects, the contractor must be prequalified as required by Florida Statute 337.14(1) and Rule Chapter 14-22. Bidders may obtain preliminary bid results at: <http://www3.dot.state.fl.us/TnspnrtLASBidLetting/>, select district then click on appropriate date.

DEADLINE for PROPOSALS and PROPOSAL HOLDERS LIST

The deadline for obtaining bid packages shall be 24 hours prior to scheduled letting date. A list of plan holders may be obtained by visiting the District Contracts Administration website at: <http://www.dot.state.fl.us/contractsadministrationdistrict1/>, and select letting date from the District 1 Lettings Menu. Please note that the list of proposal holders is confidential two working days from the deadline for obtaining bid packages (or three working days prior to scheduled letting date) and the list of Proposal, Plan and Specification Holders will be deleted and no longer available, per Florida Statutes 337.168(2).

-----NOTE-----

Proposals will not be issued after 2:00 PM Local Time on Wednesday, January 18, 2012.

Document Ordering Information

Orders for documents are placed using the Contract Proposal Processing Online Ordering System at <http://www.dot.state.fl.us/cc-admin/>. There is no charge for ordering/downloading documents. Online Ordering is available Monday through Friday from 6 AM. to 9 PM. and Saturday from 6 AM. to 7 PM.

To Place An Order

- A current State of Florida Vendor Number is required prior to first-time registration; please visit http://dms.myflorida.com/egovernment_tools/myflorida_marketplace for more information. Please allow 24 to 48 hours for receipt of a new vendor number.
- Prior to placing orders, an individual shall register and establish an Internet Subscriber Account with the Department of Transportation at <http://www.dot.state.fl.us/cc-admin/>. Please allow 48 to 72 hours (excluding weekends and holidays) for the registration and approval.

PREQUALIFICATION

A contractor desiring to bid for the performance of any construction contract in excess of \$250,000.00 must first be certified by the Department as qualified in accordance with Section 337.14(1), Florida Statutes, and Rule 14-22, Florida Administrative Code. Maintenance contracts do not require a contractor to have a certificate of qualification, unless stipulated in the project description and specifications. If deemed necessary by the Department, certain maintenance contracts will contain specific requirements for maintenance contractor eligibility.

SCRUTINIZED COMPANIES

A company that is on the Scrutinized Companies with Activities in Sudan List or the Scrutinized Companies with Activities in the Iran Petroleum Energy Sector List may not bid on, submit a proposal for, or enter into a contract with an agency or local government entity for goods or services of \$1 million or more.

BID REJECTION

Bidders are hereby notified that all bids on any of the following projects are likely to be rejected if the lowest responsive bid received exceeds the engineer's estimate by more than ten percent (10%). In the event any of the bids are rejected for this reason, the project may be deferred for re-advertising. In addition, award of all federally funded projects will be subject to Federal Highway Administration concurrence.

PROTEST RIGHTS

Pursuant to Section 337.11, Florida Statutes, any person adversely affected by a **bid solicitation** shall file both a notice of protest and bond within 72 hours of the receipt of the bid documents, and shall file a formal written protest within ten days after filing the notice of protest. Any person who files a notice of protest as to a bid solicitation pursuant to this rule shall post with the Department, at the time of filing the notice of protest, a bond payable to the Department in the following amounts: For an action protesting a bid solicitation that requires qualification of bidders, the Bond shall be \$5,000. For an action protesting a bid solicitation for which bidders are not required to be prequalified by the Department to be eligible to bid, the bond shall be \$2,500. The required notice of protest, bond and formal protest must each be timely filed with the Clerk of Agency Proceedings, Florida Department of Transportation, Mail Station 58, Room 550, 605 Suwannee Street, Tallahassee, Florida 32399-0458. Failure to file a protest within the time prescribed in Section 120.57(3), Florida Statutes, shall constitute a waiver of proceedings under Chapter 120, Florida Statutes.

Pursuant to Section 337.11, Florida Statutes, any person adversely affected by a **bid rejection or contract award** shall file both a notice of protest and bond within 72 hours after the posting of the Summary of Bids. If notice of intended decision is given by certified mail or express delivery, the adversely effected person must file both the notice of protest and bond within 72 hours after receipt of the notice of intent. A formal written protest must be filed within ten days after filing the notice of protest. Any person who files a notice of protest as to a bid rejection or contract award pursuant to this rule shall post with the Department, at the time of filing the notice of protest, a bond payable to the Department in the following amounts: For an action protesting a bid rejection or contract award that requires qualification of bidders, the Bond shall be equal to one percent of the lowest bid submitted or \$5,000, whichever is greater. For an action protesting a bid rejection or contract award for which bidders are not required to be prequalified by the Department to be eligible to bid, the bond shall be \$2,500. The required notice of protest, bond and formal protest must each be timely filed with the Clerk of Agency Proceedings, Florida Department of Transportation, Mail Station 58, Room 550, 605 Suwannee Street, Tallahassee, Florida 32399-0458. Failure to file a protest within the time prescribed in Section 120.57(3), Florida Statutes, shall constitute a waiver of proceedings under Chapter 120, Florida Statutes.

A protest is not timely filed unless the notice of protest, bond and the formal protest are each received by the Clerk of Agency Proceedings within the required time limits. A protest which is filed prematurely will be deemed abandoned unless timely renewed.

INSURANCE

The successful bidder shall submit current general liability insurance and workman's compensation insurance certificates for the duration of the contract in the dollar amounts and manner specified in the most current edition of the Department's Standard Specifications for Road and Bridge Construction. Insurance companies must be authorized to do business in the State of Florida. Proof of such insurance shall be filed with the District Contracts and Procurement Office before the contract can be executed. BE SURE THAT THE CONTRACT NUMBER IS ON EACH INSURANCE CERTIFICATE.

ADDENDA

No negotiations, decisions, or actions will be initiated or executed by a potential bidder as a result of any oral discussion with a State employee. Only those communications which are in writing from the Department will be considered as a duly authorized expression on behalf of the Department. Notices of changes (addenda) will be posted on the District Contracts Administration website at: <http://www.dot.state.fl.us/contractsadministration/district1/>, and select letting date from the District 1 Lettings Menu. It is the responsibility of all potential bidders to monitor this site for any changing information prior to submitting their bid. **All addenda will be acknowledged by signature and subsequent submission of addenda**

with the bid when so stated in the agenda.

BID QUESTIONS

Direct questions regarding the advertised projects by posting them to the Department website at the following URL address: <http://www2.dot.state.fl.us/construction/bidquestionmain.asp>

MAINTENANCE

PROPOSAL ID:	E1K79-R0	PROJECT(S): 43174717201 (*)	COUNTY:	HIGHLANDS
DESCRIPTION:	The Improvements under this Contract consist of delivery, placement and maintenance of sod until established in Highlands County.			
	• Contract Days: 365		• Budget Amount: \$136,000.00	
	• Contract Execution Days: 10		• Acquis/Flexible Start Time: N/A	
	• Proposal Package Fee(plans+proposal): \$0.00		• Plans Only Fee: \$0.00	• Specs Only Fee: \$0.00
PROPOSAL ID:	E1K80-R0	PROJECT(S): 43174517201 (*)	COUNTY:	OKEECHOBEE
DESCRIPTION:	The Improvements under this Contract consist of delivery, placement and maintenance of sod until established in Okeechobee County.			
	• Contract Days: 365		• Budget Amount: \$136,000.00	
	• Contract Execution Days: 10		• Plans Only Fee: \$0.00	• Specs Only Fee: \$0.00
	• Proposal Package Fee(plans+proposal): \$0.00		• Plans Only Fee: \$0.00	• Specs Only Fee: \$0.00
PROPOSAL ID:	E1K81-R0	PROJECT(S): 43142017201 (*)	COUNTY:	MANATEE SARASOTA
DESCRIPTION:	The Improvements under this Contract consist of Herbicide Application in Manatee & Sarasota County.			
	• Contract Days: 365		• Budget Amount: \$49,833.00	
	• Contract Execution Days: 10		• Plans Only Fee: \$0.00	• Specs Only Fee: \$0.00
	• Proposal Package Fee(plans+proposal): \$0.00		• Plans Only Fee: \$0.00	• Specs Only Fee: \$0.00
PROPOSAL ID:	E1K82-R0	PROJECT(S): 42943017201 (*)	COUNTY:	MANATEE SARASOTA
DESCRIPTION:	The Improvements under this Contract consist of Highway Lighting Maintenance on the Primary Roadway System in Manatee & Sarasota Counties.			
	• Contract Days: 365		• Budget Amount: \$24,250.00	
	• Contract Execution Days: 10		• Plans Only Fee: \$0.00	• Specs Only Fee: \$0.00
	• Proposal Package Fee(plans+proposal): \$0.00		• Plans Only Fee: \$0.00	• Specs Only Fee: \$0.00
PROPOSAL ID:	E1K83-R0	PROJECT(S): 42942317201 (*)	COUNTY:	HARDEE DESOTO MANATEE SARASOTA
DESCRIPTION:	The Improvements under this Contract consist of Mechanical Sweeping of Bridges, Curbs and Gutters in Hardee, Desoto, Manatee, & Sarasota Counties.			
	• Contract Days: 365		• Budget Amount: \$40,000.00	
	• Contract Execution Days: 10		• Plans Only Fee: \$0.00	• Specs Only Fee: \$0.00
	• Proposal Package Fee(plans+proposal): \$0.00		• Plans Only Fee: \$0.00	• Specs Only Fee: \$0.00
PROPOSAL ID:	E1K84-R0	PROJECT(S): 42946117201 (*)	COUNTY:	MANATEE SARASOTA
DESCRIPTION:	The Improvements under this Contract consist of Herbicide Strip Application in Manatee & Sarasota Counties.			
	• Contract Days: 365		• Budget Amount: \$100,000.00	
	• Contract Execution Days: 10		• Plans Only Fee: \$0.00	• Specs Only Fee: \$0.00
	• Proposal Package Fee(plans+proposal): \$0.00		• Plans Only Fee: \$0.00	• Specs Only Fee: \$0.00
PROPOSAL ID:	E1K85-R0	PROJECT(S): 42941817201 (*)	COUNTY:	MANATEE SARASOTA
DESCRIPTION:	The Improvements under this Contract consist of Edging and Sweeping, Removal and Disposal of Vegetation from Curb and Gutter and Sidewalk Areas in Manatee & Sarasota Counties.			
	• Contract Days: 365		• Budget Amount: \$110,152.00	
	• Contract Execution Days: 10		• Plans Only Fee: \$0.00	• Specs Only Fee: \$0.00
	• Proposal Package Fee(plans+proposal): \$0.00		• Plans Only Fee: \$0.00	• Specs Only Fee: \$0.00
PROPOSAL ID:	E1K86-R0	PROJECT(S): 42944717201 (*)	COUNTY:	MANATEE
DESCRIPTION:	The Improvements under this Contract consist of Roadside Mowing, Litter Removal, and Chemical Vegetation Control using inside Mowing Deck Application in Manatee County.			
	• Contract Days: 365		• Budget Amount: \$315,000.00	
	• Contract Execution Days: 10		• Plans Only Fee: \$0.00	• Specs Only Fee: \$0.00
	• Proposal Package Fee(plans+proposal): \$0.00		• Plans Only Fee: \$0.00	• Specs Only Fee: \$0.00

PROPOSAL ID: E1K87-R0 PROJECT(S): 42772117201 (*)

COUNTY: DESOTO

DESCRIPTION:

The Improvements under this Contract consist of Roadside Mowing, Litter Removal, Under Deck Herbicide Application and Edging and Sweeping in Desoto County.

- Contract Days: 365
- Contract Execution Days: 10
- Proposal Package Fee(plans+proposal): \$0.00
- Budget Amount: \$342,000.00
- Plans Only Fee: \$0.00
- Specs Only Fee: \$0.00

PROPOSAL ID: E1K88-R0 PROJECT(S): 42772217201 (*)

COUNTY: HARDEE

DESCRIPTION:

The Improvements under this Contract consist of Roadside Mowing, Litter Removal, Under Deck Herbicide Application and Edging and Sweeping in Hardee County.

- Contract Days: 365
- Contract Execution Days: 10
- Proposal Package Fee(plans+proposal): \$0.00
- Budget Amount: \$251,500.00
- Plans Only Fee: \$0.00
- Specs Only Fee: \$0.00

BID BOND

For bids over \$150,000.00, the standard proposal guaranty of 5% of the bid will be required. A Proposal Guaranty of not less than five percent (5%) of the total actual bid in the form of either a certified check, cashier's check, trust company treasurer's check, bank draft of any national or state bank, or a Surety Bid Bond made payable to the Florida Department of Transportation must accompany each bid in excess of \$150,000.00. A check or draft in an amount less than five percent (5%) of the actual bid will invalidate the bid. The guaranty amount shall include all bid items except construction days for A+B bidding and lane closure for Lane Rental Bidding. Bid Bonds shall conform to DOT Form 375-020-09 furnished with the Proposal. Surety2000 or SurePath electronic Bid Bond submittal may be used in conjunction with Bid Express internet bid submittal. For more information please visit <http://www.surety2000.com> for Surety2000 or <http://www.insurevision.com> for SurePath. Paper Bid Bonds will be also be accepted for bids submitted through Bid Express provided they are received prior to the deadline for receiving bids, by the location(s) identified in this Bid Solicitation Notice for receiving bids for the advertised project(s).

PREQUALIFIED CONTRACTORS CURRENT CAPACITY

In order for the Department to have the information required to determine a prequalified bidder's Current Capacity, it is necessary that the prequalified contractor certify the total dollar amount of all work the contractor has underway. This certification shall be accomplished electronically by submitting the Certification of Work Underway (Online Web Application) http://www.dot.state.fl.us/cc-admin/PreQual_Info/prequalified.shtm to the Department concurrently with the bid submittal for the first letting in the calendar month that the contractor submits a bid.

EXECUTION OF CONTRACT

Pursuant to Subsections 3-6 and 3-7 of the Standard Specifications, the successful bidder shall execute the necessary contract documents and return the agreement along with a satisfactory Performance and Payment Bond within ten (10) Calendar days of award, excluding Saturdays, Sundays, and state holidays, unless noted otherwise in the project specifications. A 100% Payment and Performance Bond will be required for all projects unless noted otherwise in the project specifications. All work is to be done in accordance with the Plans, special Provisions of the State of Florida Department of Transportation.

Prior to execution of the contract with the Department, a corporation must show proof that is authorized to do business in the State of Florida. Florida corporations should provide a copy of the certificate of Incorporation and foreign corporations should provide a copy of Certificate of Authority from the Florida Department of State.

Important note: Actual commitment and final execution of the contract is contingent upon an approved legislative budget and funds availability.

PROPOSAL REVISIONS

The Department will accept legible facsimile (fax) proposal revisions pursuant to the project specifications at Fax No. (863) 519-2661 if received in full by 2:00 PM Local Time on the day of the letting. A faxed proposal revision will not be considered if received at a different fax number. The bid/proposal must be received in the District Contracts and Procurement Office prior to receiving changes through the Fax.

DBE PARTICIPATION

Disadvantaged Business Enterprise (DBE) Availability Goal Information is contained in the Bid Solicitation Package. Please complete, sign, and return the applicable "Anticipated DBE Participation Statement" form and the "DBE/MBE Bid Opportunity List" form which shall be submitted with bid as stipulated in the subject bid packages.

DEBARMENT/SUSPENSION

All bids submitted to the Department shall include a statement that by signing and submitting this proposal, the bidder certifies that no principal (which includes officers, directors or executives) is presently debarred, suspended, proposed for debarment, declared ineligible or voluntarily excluded from participation in this transaction by any federal department or agency.

MANDATORY PRE-BID CONFERENCE

Proposal forms (bid packages) will be issued only to attendees of the mandatory pre-bid conference (if there is a mandatory pre-bid conference for a project).

LATE ARRIVALS TO MANDATORY PRE-BID MEETINGS

All bidders must be present and signed in prior to the start of the mandatory prebid meeting. Anyone not signed in at the commencement of the meeting will be considered late and will not be allowed to bid on the project.

FIRST TIME BIDDERS

Bidders bidding for the first time with the Department can request an orientation meeting to obtain information about the bidding/contracting process. Contact the office listed for ordering plans. Please call (863) 519-2559 or (800) 292-3368 for further details.

POSTING NOTICE

Unless otherwise notified by certified mail, express delivery, hand delivery, fax, or email, receipt acknowledgment, the Summary of Bids will be posted at the District Contracts Administration web site <http://www.dot.state.fl.us/contractsadministrationdistrict1/>, and select letting date from the District 1 Lettings Menu, on **February 07, 2012** or in the alternative **February 14, 2012**. Additionally a hard copy will be posted on the first floor bulletin board at the District One Headquarters Building, Florida Department of Transportation, District Office Complex, 801 North Broadway Avenue, Bartow, Florida 33830, and will remain posted for a period of seventy-two (72) hours. By calling (863) 519-2559, during each posting period, information concerning the posted projects can be obtained. The posting provides notice of the Department's intent to award a contract or reject all bids. The Department's Notice of Intent regarding a project will be posted on only one of the alternate posting dates. Bidders are solely responsible for timely monitoring or otherwise verifying on which of the specified alternate posting dates the posting of award or rejection of all bids actually occurs.

If the posting dates are revised, all bidders for the subject project will be notified of the Department's intended decision. Bidders must acknowledge receipt of the notice of the revised date.

AFFIRMATIVE ACTION (EQUAL EMPLOYMENT OPPORTUNITY)

The Florida Department of Transportation (hereinafter referred to as the "Department"), in accordance with Title VI of the Civil Rights Act of 1964, 42 USC 2000d to 2000d-4 and related authorities, Title 49, Code of Federal Regulations, U.S. Department of Transportation, Subtitle A, Office of the Secretary, Part 21, Nondiscrimination in Federally-assisted programs of the U.S. Department of Transportation issued pursuant to such Act, hereby notifies all bidders that the Department will affirmatively insure that in any contract entered into pursuant to this advertisement, minority and disadvantaged business enterprises will be afforded the full opportunity to submit bids in response to this invitation and will not be discriminated against on the basis of race, color, national origin, religion, sex, age, or disability/handicap in consideration for an award. Further, it is the policy of the Department to not discriminate against bidders on the grounds of race, color, national origin, religion, sex, age, or disability/handicap in consideration for an award. A bidder must have an approved DBE Affirmative Action (DBE/AA) Plan prior to contract award. Please use the following link http://www.dot.state.fl.us/cc-admin/cpp_online_ordering/bidder_assist.shtm and the Special Provisions for instructions for

submission of a DBE/AA Plan. The DBE/AA Plan should be submitted for approval prior to the bidding.

MINIMUM WAGE

The minimum wage for all hours worked in Florida shall be \$7.31 per hour, effective June 1, 2011.

EMAIL SUBSCRIPTION LIST

To get on the e-mail subscription list, go to <http://www2.dot.state.fl.us/ContractsAdministration/bsnmail.asp> and fill out the necessary information to "Subscribe". To obtain information concerning other districts, go to <http://www.dot.state.fl.us/cc-admin/distco.shtm>

STATE OF FLORIDA DEPARTMENT OF TRANSPORTATION

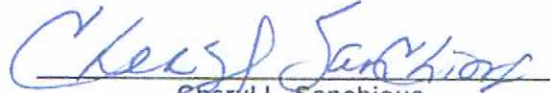

Cheryl L. Sanchious
District Contracts Administrator

NOTICE TO ALL BIDDERS

To report bid rigging activities call: 1-800-424-9071

The U.S. Department of Transportation (DOT) operates the above toll-free "hotline" Monday through Friday, 8:00 a.m. to 5:00 p.m. local time. Anyone with knowledge of possible bid rigging, bidder collusion, or other fraudulent activities should use the "hotline" to report such activities. The "hotline" is part of the DOT's continuing effort to identify and investigate highway construction contract fraud and abuse and is operated under the direction of the DOT Inspector General. All information will be treated confidentially and caller anonymity will be respected.



PROPOSAL OF

Star Cleaning USA Inc

(Proposer's Firm Name) (Prequalified Name, if Applicable)

1966A SW 69 Pl, Pembroke Pines FL 33332

(Proposing Firm's Physical Address - City - State - Zip)

F.E.I.D. No. 65-0684451 Telephone No. (954) 680-7827 FAX No. (954) 434-6967

Email Address: StarCleaningUSA@hotmail.com

for constructing or otherwise improving a Bridge(s) and/or Section(s) of Road(s) No(s). or building(s) On the primary

in Hardee, Desoto, Manatee, & Sarasota County(ies),

The Improvements under this Contract consist of Mechanical Sweeping of Bridges, Curbs and Gutters

approximately N/A

in length, and known as Federal Aid Project No(s): N/A

Contract No.: E1K83-R0 Financial Project No(s): 429423-1-72-01

TO THE STATE OF FLORIDA, DEPARTMENT OF TRANSPORTATION: Submitted

The Bidder, hereby declares that no person or persons, firm or corporation, other than the Bidder, is interested, in this proposal, as principals, and that this Proposal is made without collusion with any person, firm or corporation, and we have carefully and to our full satisfaction examined the Proposal forms, the Standard Specifications as amended by the Specifications Package and any Supplemental Specifications Packages, and the Plans, and that we have made a full examination of the location of the proposed work and the sources of supply of materials, and we hereby agree to furnish all necessary labor, equipment, and materials, fully understanding that the quantities shown herewith are approximate only, and that we will fully complete all necessary work in accordance with the Plans and Specifications, and the requirements under them of the Engineer, within the time limit specified in this Proposal for the following unit prices, to wit:

Was an addendum issued on this project?

Yes No

Table with 4 columns: Addendum No., Dated, Addendum No., Dated. Header: I (We) hereby acknowledge receipt of the following Addenda issued during the bidding period.

The Bidder agrees to perform all necessary work, as provided for in the contract, and if awarded the contract, to execute the Contract within 10 calendar days, excluding Saturdays, Sundays, and state holidays, after the date on which the notice of award has been given, and to fully complete all necessary work under the same within not more than 365 calendar days. It is understood and agreed that the date on which calendar days will begin to be charged to the project shall be either (1) the 14 calendar day from the date of issuance of the initial notice to begin work or (2) the date on which the Bidder actually begins work, whichever date is the earlier. The Bidder further agrees to furnish a sufficient and satisfactory bond in the sum of not less than 100 percent of the Contract price of the work as indicated by the approximate quantities shown herein.

The Bidder further agree(s) to bear the full cost of maintaining all work until final acceptance, as provided in the Contract.

If the total amount of this bid exceeds \$150,000.00, a bid guaranty of five percent (5%) of the bid, payable to the Florida Department of Transportation, must accompany this proposal. The guaranty amount shall include all bid items except construction days for A+B Bidding and lane closure for Lane Rental Bidding. If this proposal is accepted and the Bidder fails to execute the Contract under the conditions of this proposal, the bid guaranty shall be forfeited to the Department; otherwise, said guaranty is to be returned to the Bidder upon delivery of a satisfactory bond. The Florida Department of Transportation officials and employees are prohibited by law from soliciting and accepting funds or gifts from any person who has, maintains, or seeks business relations with the Department pursuant to Section 334.195, Florida Statutes.

The Bidder, hereby certifies that it has carefully examined this proposal after the same was completed, and has verified each item placed thereon. The Bidder agrees to indemnify, defend, and save harmless, the Department against any cost, damage, or expense which it may incur or be caused by any error in the Bidder's preparation of same. By signing and submitting this proposal, the Bidder certifies that no principal (which includes officers, directors, or executives) is presently debarred, suspended, proposed for debarment, declared ineligible, or voluntarily excluded from participation in this transaction by any federal department or agency.

The Bidder hereby certifies that the submitted unit price sheets are generated from the diskette provided by the STATE OF FLORIDA, DEPARTMENT OF TRANSPORTATION or accurate reproductions generated from the Department's issued Expedite Bidding System (EBS) program. If any errors have been made by the Bidder in preparing the generated sheets, the Bidder hereby consents that such errors will be applied by the Department in the manner most beneficial to the Department.

The Bidder hereby certifies and obligates its firm as "Principal (bidder)" to the attached Bid or Proposal Bond, (Form 375-020-09) as if and to the same effect as if the Bidder had affixed its signature thereon.

Section 287.134(3)(a), Florida Statutes, requires: An entity or affiliate who has been placed on the discriminatory vendor list may not submit a bid on a contract to provide any goods or services to a public entity, may not submit a bid on a contract with a public entity for the construction or repair of a public building or public work, may not submit bids on leases of real property to a public entity, may not be awarded or perform work as as contractor, supplier, subcontractor, or consultant under a contract with any public entity, and may not transact business with any public entity.

Section 553.62, Florida Statutes, incorporates the Occupational Safety and Health Administration's (OSHA) safety standards, 29 CFR s. 1926.650 Subpart P, as the state standard. The Department of Labor and Employment Security may adopt updated or revised versions by rule. Other state or political subdivisions may also have standards that are applicable. If trench excavation will be required on the project in excess of five feet in depth, the Bidder must identify the cost of compliance with the applicable trench safety standards below. If there will be no trench excavation on the project in excess of five feet in depth, write "not applicable" below.

	Trench Safety Measure (Description)	Units of Measure	Quantity	Unit Cost	Extended Cost
A.	<u>N/A</u>	<u>N/A</u>	<u>N/A</u>	<u>N/A</u>	<u>N/A</u>
B.	<u>N/A</u>	<u>N/A</u>	<u>N/A</u>	<u>N/A</u>	<u>N/A</u>
C.	<u>N/A</u>	<u>N/A</u>	<u>N/A</u>	<u>N/A</u>	<u>N/A</u>
(ATTACH SEPARATE SHEET IF NECESSARY)					TOTAL: \$ <u> </u>

If applicable, this certifies that all trench excavation done within the control of the contractor will be in accordance with all applicable standards and with the specifications, and all requirements of Sections 553.63(1)(a), 553.63(1)(b), and 553.63(1)(c), Florida Statutes.

Job No(s):

429423-1-72-01

The Bidder hereby declares that the undersigned is the person or persons responsible within the firm for the final decision as to the price(s) and amount of this bid and the Bidder further declares that:

1. The price(s) and amount of this bid have been arrived at independently, without consultation, communication, or agreement for the purpose of restricting competition with any other contractor, bidder or potential bidder.
2. Neither the price(s) nor the amount of this bid have been disclosed to any other firm or person who is a bidder or potential bidder on this project, and will not be so disclosed prior to the bid opening.
3. No attempt has been made or will be made to solicit, cause, or induce any firm or person to refrain from bidding on this project, or to submit a bid higher than the bid of this firm, or any intentionally high or non-competitive bid or other form of complementary bid.
4. The bid is made in good faith and not pursuant to any agreement or discussion with, or inducement from, any other firm or person to submit a complementary bid.
5. The Bidder has not offered or entered into a subcontract or agreement regarding the purchase of materials or services from any other firm or person, or offered, promised, or paid cash or anything of value to any other Bidder or person, whether in connection with this or any other project, in consideration for an agreement or promise by any other firm or person to refrain from bidding or to submit a complementary bid on this project.
6. The Bidder has not accepted or been promised any subcontract or agreement regarding the sale of materials or services to any other firm or person, and has not been promised or paid cash or anything of value by any other firm or person, whether in connection with this or any other project, in consideration for the firm's submitting a complementary bid, or agreeing to do so, on this project.
7. The Bidder has made a diligent inquiry of all members, officers, employees, and agents of the Bidder with responsibilities relating to the preparation, approval or submission of the firm's bid on this project and have been advised by each of them that he or she has not participated in any communication, consultation, discussion, agreement, collusion, act, or other conduct inconsistent with any of the statements and representations made in this Declaration.
8. As required by Section 337.165, Florida Statutes, the Bidder has fully informed the Florida Department of Transportation in writing of all convictions of the firm, its affiliates (as defined in Section 337.165(1)(a), Florida Statutes), and all directors, officers, and employees of the firm and its affiliates for violation of state or federal antitrust laws with respect to a public contract or for violation of any state or federal law involving fraud, bribery, collusion, conspiracy, or material misrepresentation with respect to a public contract. This includes disclosure of the names of current employees of the firm or affiliates who were convicted of contract crimes while in the employ of another company.
9. The Bidder certifies that, except as noted below, neither the firm nor any person associated therewith in the capacity of owner, partner, director, officer, principal, investigator, project director, manager, auditor, and/or position involving the administration of federal funds:
 - (a) is presently debarred, suspended, proposed for debarment, declared ineligible, or voluntarily excluded from covered transactions, as defined in 49 CFR s29.110(a), by any federal department or agency;
 - (b) has within a three-year period preceding this certification been convicted of or had a civil judgment rendered against it for: commission of fraud or a criminal offense in connection with obtaining, attempting to obtain, or performing a federal, state, or local government transaction or public contract; violation of federal or state antitrust statutes; or commission of embezzlement, theft, forgery, bribery, falsification or destruction of records, making false statements, or receiving stolen property;
 - (c) is presently indicted for or otherwise criminally or civilly charged by a federal, state, or local governmental entity with commission of any of the offenses enumerated in paragraph 9(b) of this certification; and
 - (d) has within a three-year period preceding this certification had one or more federal, state, or local government public transactions terminated for cause or default.
10. The Bidder certifies that it shall not knowingly enter into any transaction with any subcontractor, material supplier, or vendor who is debarred, suspended, declared ineligible, or voluntarily excluded from participation in this project by any federal agency unless authorized by the Florida Department of Transportation.
11. The firm certifies that the bidder is not a nonresident alien, or a foreign corporation/entity formed under the laws of a country other than the United States.
12. The Bidder certifies that the company is not on the Scrutinized Companies with Activities in Sudan List or the Scrutinized Companies with Activities in the Iran Petroleum Energy Sector List.

Where the Bidder is unable to declare or certify as to any of the statements contained in the above stated paragraphs numbered (1) through (12), the Bidder has provided an explanation in the "Exceptions" portion on page 4 of 4 or by attached separate sheet.

EXCEPTIONS:

Any exception listed above will not necessarily result in denial of award, but will be considered in determining bidder responsibility. For any exception noted, indicate to whom it applies, initiating agency, and dates of agency action. Providing false information may result in criminal prosecution and/or administrative sanctions. I declare under penalty of perjury that the foregoing is true and correct.

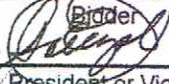
<p>CORPORATION: <u>Star Cleaning USA Inc.</u></p> <p style="text-align: center;">(Bidder)</p> <p>Signature: <u></u> President or Vice President (Circle Title)</p> <p style="text-align: center;"><u>ENRIQUE GONZALEZ</u> Print Name</p> <p>(Affix Corporate Seal)</p>	<p>INDIVIDUAL OR FIRM TRADING AS:</p> <p>_____</p> <p style="text-align: center;">Bidder</p> <p>Signature: _____</p> <p style="text-align: center;">Individual or Owner</p> <p>_____</p> <p style="text-align: center;">Print Name</p>
<p>PARTNERSHIP</p> <p>_____</p> <p style="text-align: center;">Bidder</p> <p>Signature: _____</p> <p style="text-align: center;">General Partner (Circle Title)</p> <p>_____</p> <p style="text-align: center;">Print Name</p> <p>Signature: _____</p> <p style="text-align: center;">General Partner (Circle Title)</p> <p>_____</p> <p style="text-align: center;">Print Name</p>	<p>JOINT VENTURE:</p> <p>_____</p> <p style="text-align: center;">Bidder</p> <p>Signature: _____</p> <p style="text-align: center;">Attorney-in-Fact</p> <p>_____</p> <p style="text-align: center;">Print Name</p>
<p>LIMITED LIABILITY COMPANY:</p> <p>_____</p> <p style="text-align: center;">Contractor</p> <p>Signature: _____</p> <p style="text-align: center;">Manager or Member (Circle Title)</p> <p>_____</p> <p style="text-align: center;">Print Name</p>	<p>CONTRACTOR: _____ (Seal)</p> <p>Signature: _____</p> <p style="text-align: center;">President or Vice President (Circle Title)</p> <p>CONTRACTOR: _____ (Seal)</p> <p>Signature: _____</p> <p style="text-align: center;">President or Vice President (Circle Title)</p> <p>CONTRACTOR: _____ (Seal)</p> <p>Signature: _____</p> <p style="text-align: center;">President or Vice President (Circle Title)</p>
<p>Organized and existing under the laws of the State of <u>FLORIDA</u> and authorized to do business in the State of Florida, pursuant to the laws of the State of Florida, certificate of incorporation or organization or certificate of authority having been issued by the Florida Department of State.</p>	

FAILURE TO FULLY COMPLETE AND EXECUTE THIS DOCUMENT MAY RESULT IN THE BID BEING DECLARED NONRESPONSIVE

ATTACH BID BOND

Job No(s):

429423-1-72-01

To: Honorable Mayor, Vice-Mayor and Members of the Town Commission

From: Guillermo Olmedillo, Town Manager

Date: April 14, 2020

Subject: Design Review Board

Previously, the Town's design review process included two boards, the Planning and Zoning Board and the Design Review Board. The Planning and Zoning Board consisted of 5 members appointed by the Town Commission. The Design Review Board included the 5 Planning and Zoning Board Members and required two additional members and would meet on the same night. One of the additional members had to be a Florida-licensed architect or landscape architect while the second member could be an architect, landscape architect, engineer, city planner, general contractor, interior designer, or attorney.

Because these two Boards had overlapping members and functions, it proved difficult to have a quorum, specifically for the Design Review Board as one of the two additional members had to be present. If not present, the meeting was canceled and items to be heard were rescheduled to the following meeting. Also, there was difficulty finding and appointing qualified persons to serve on the Design Review Board. Ordinance No. 18-1689 adopted on April 14, 2018 (codified in Sections 90-14 to 90-23 of the Town Code), incorporated the functions of the Design Review Board within the Planning and Zoning Board. In addition, two alternate members were added to the Planning and Zoning Board to ensure that a quorum exists for each meeting. If all five members of the Planning and Zoning Board are in attendance, the two alternates become non-voting members.

The 2018 Ordinance dissolved the Design Review Board and provided for design review functions to be incorporated and taken up by the Planning and Zoning Board. The newly constituted Planning and Zoning Board is made up of seven members, two of which are alternates who vote when any member of the Planning and Zoning is not present. The requirements were also modified to indicate that three of the members, which include the alternates, must have specific qualifications. Previously, only Design Review members were required to have qualifications.

Since the adoption of the Ordinance in 2018 that dissolved Design Review and provided for the functions by the Planning and Zoning Board, the Planning and Zoning Board has not had to cancel a meeting due to a lack of a quorum. Those applications needing approval based on design review are processed at the beginning of the meeting followed by those items that require approval for consistency with the Zoning Code. In sum, design review functions still occur as required by the Town Code, but are performed by the Planning & Zoning Board.

Staff recommends the design review function remain with the Planning and Zoning Board to avoid quorum issues and overlapping functions and provide for a clear, concise and timely process for applicants.

ORDINANCE NO. 18 - 1689

AN ORDINANCE OF THE TOWN OF SURFSIDE, FLORIDA AMENDING CHAPTER 90 “ZONING” OF THE TOWN OF SURFSIDE CODE OF ORDINANCES TO ABOLISHING THE DESIGN REVIEW BOARD, MODIFYING THE PLANNING AND ZONING BOARD MEMBERSHIP AND RESPONSIBILITIES, ABOLISHING THE DEVELOPMENT IMPACT COMMITTEE, AND REVISING THE DESIGN REVIEW GROUP REVIEW REQUIREMENTS; PROVIDING FOR REPEAL OF CONFLICTING PROVISIONS; PROVIDING FOR SEVERABILITY; PROVIDING FOR INCLUSION IN THE CODE; AND PROVIDING FOR AN EFFECTIVE DATE.

WHEREAS, the Town Commission of the Town of Surfside, Florida, recognizes that changes to the adopted Code of Ordinances are periodically necessary in order to ensure that the Town’s regulations are current and consistent with the Town’s planning and regulatory needs; and

WHEREAS, the Town wishes to abolish the Design Review Board and provide for design review by the Planning and Zoning Board so the functions of zoning and design review are consolidated in the Planning and Zoning Board; and

WHEREAS, the Town desires to abolish the Development Impact Committee to reduce duplicative efforts and consolidate review in the administrative design review process; and

WHEREAS, the Town Commission held its first public hearing on these regulations on August 14, 2018; and

WHEREAS, the Planning and Zoning Board, sitting as the Local Planning Agency, has reviewed the revisions to the Code for consistency with the Town’s Comprehensive Plan at a duly noticed hearing on August 30, 2018 and

WHEREAS, the Town Commission has conducted a second duly noticed public hearing on these regulations as required by law on August 14, 2018; and

WHEREAS, the Town Commission hereby finds and declares that adoption of this Ordinance is necessary, appropriate, and advances the public interest.

NOW THEREFORE, BE IT ORDAINED BY THE TOWN COMMISSION OF THE TOWN OF SURFSIDE, FLORIDA, AS FOLLOWS:

Section 1. Recitals. Each of the above stated recitals is true and correct and the recitals are incorporated herein by this reference.

Section 2. Code Amendment. The Code of Ordinances of the Town of Surfside, Chapter 90 “Zoning,” is hereby amended as follows¹:

* * *

DIVISION 1. - PLANNING AND ZONING BOARD

Sec. 90-14. - Created.

There is created a town planning and zoning board.

Sec. 90-15. - Membership/quorum, minimum qualifications, officers, terms of officers, vacancies, general regulations, recommendations, expenditures, indebtedness.

(1) *Membership/quorum:* The planning and zoning board membership and quorum requirements for zoning matters and design review matters are as follows:

(a) *Zoning matters:* The planning and zoning board, ~~when performing its zoning functions,~~ shall consist of five members and a first alternate member and a second alternate member. ~~At least three of the Two~~ members or alternates must be one of the following:

1. Florida-licensed general contractor or a construction management professional with at least three years of professional experience as a construction project manager, construction superintendent or construction estimator;
2. Florida licensed PE or a civil, mechanical, electrical, chemical or environmental engineer with a baccalaureate degree in engineering and three years of professional experience;
3. Certified planner (AICP) or a planning professional with a graduate degree in planning from a program accredited by the Planning Accreditation Board with at least three years of professional planning experience or a bachelor's degree in planning from a program, accredited by the Planning Accreditation Board (PAB) with at least three years of professional planning experience;
4. Florida-licensed landscape architect with at least three years of professional experience;
5. Registered interior designer with at least three years of professional experience;
6. Florida-licensed attorney with at least three years of professional experience;
7. Florida-licensed architect; or
87. Real estate developer with three years of professional experience, either as the principal or executive.

¹ Additions to text are shown in yellow underline. Deletions to text are shown in ~~yellow strikethrough~~.

- (b) *Alternate participation.* Alternates shall be subject to the same attendance and participation requirements as members. Alternates may participate in all board discussions but may not vote unless sitting as a substitute for a member. In the event a member is absent or unable to participate in an item before the board, the first alternate or if the first alternate is unavailable, the second alternate, shall fill the absent or recused member's position for the duration of that member's absence.
- (c) *All board matters:* One town commissioner shall be a liaison, non-voting representative without a vote at all planning and zoning board meetings.
- (2) *Minimum board member qualifications:* All board members must have been a town resident for a minimum period of one year, except for the licensed architects, including the Florida-licensed landscape architect, if applicable, who must have been a town residents for a minimum period of six months. ~~The Florida-licensed architects must have a minimum of five years of practical experience in the field of landscape design. To the extent that no licensed architect (whether for service on the planning and zoning board or design review board only as more specifically described in section 90-18 hereinbelow) who is also a town resident can be identified and is willing to serve at the time of appointment to either board, then the commission may select a non-resident architect who otherwise fulfills the requirements of this section, provided that appointment shall be ratified by a majority of the board of commissioners. To the extent an architect (resident or non-resident) cannot be located within three (3) months of the vacancy, this requirement may after a majority vote of the commission become null and void until such time this board member vacates the position before his/her term expires or a full new board is appointed whichever comes first.~~
- (3) *Officers:* The board shall elect one of its members as chairman and one of its members as vice-chairman, at its first regular meeting in April of each year. In the event of the resignation, removal, or inability of the chairman to serve, the vice-chairman shall succeed to the chairman position for the unexpired term; and the board shall, thereupon, elect one of its members as vice-chairman for the unexpired term. The chairman shall preside at all meetings. In the chairman's absence, the vice-chairman shall preside. The chairman shall submit all board reports and recommendations to the town commission, by and through the chairman, vice-chairman or the town commission liaison member. The town shall provide a secretary for the board and the town clerk shall be custodian of all records, books and journals of the board.
- (4) *Board member term(s):* Each commissioner shall be responsible for one board member appointment. The first and second alternates shall be appointed at-large by the majority vote of the Commission present at the meeting. The term of each board member and alternate appointment shall begin on the last Thursday of April of the year in which the board member or alternate is appointed and end when a successor ~~board member~~ is appointed or on the last Thursday in April, whichever dates comes first. The term of any board member or alternate filling a vacancy created on the board as provided in paragraph (5) shall begin at the time of the ~~board members~~ appointment and end the last Thursday in April or whenever a replacement is appointed.
- (5) *Vacancies:* A vacancy shall exist: (1) on the date that any member or alternate ceases to possess the minimum required membership qualifications provided herein; (2) when a board member or alternate has been absent from three consecutive regularly convened board

meetings or has been absent from five regularly convened board meetings within a board year; or (3) for members if the appointing commissioner resigns or his position otherwise becomes vacant during his/her term. Vacancies on the board shall be filled by appointment for the unexpired term in the same manner as original appointments are made provided however, if the seat shall remain vacant longer than a three-month period for any reason, the town commission may collectively, by majority vote, appoint a temporary member until such commission position is filled in accordance with the Town Charter and Code.

~~(6) *Transition provision:* Inasmuch as the enactment of Ordinance No. 1598 will occur mid-term, and the planning and zoning board as currently composed contains no architect, any architect currently serving on the design review board at the time of enactment, shall continue to serve in an ex officio capacity with the planning and zoning board as a nonvoting member and that the comments of that ex officio member will be considered and accorded equal weight with those who vote. Upon the expiration of the term of the current planning and zoning board, this provision shall become null and void.~~

(7) *General regulations governing members:* Board members and alternates shall be appointed in accordance with all applicable state, county and town ethics laws, rules and regulations. Appointed members and alternates of the board shall not, during their term, hold any other public office, paid position or serve on any other board under town government, except as a temporary board member, or that of a voluntary fireman.

(8) *Expenditures; indebtedness:* The town commission may authorize the expenditure by the planning and zoning board of such funds as the town commission may deem necessary to perform the requirements of this chapter. The town commission may appropriate from the general fund as set up in the annual budget and such sums as it may from time to time authorize the board to expend. The board may not incur indebtedness without prior commission approval.

Sec. 90-16. - Meetings: board year; timeframe; order of presentation; location.

(1) *Board year:* The board year shall commence on the last Thursday of April in each year.

(2) *Meetings on zoning and design review matters/timeframe:* Regular board meetings for zoning and design review matters shall be held on the last Thursday of each month. The chair may call special meetings and may cancel or continue meetings as may be necessary.

~~(3) *Meetings on design review matters/timeframe:* The board shall meet as needed on design review matters. The chairman may call special meetings and may cancel or continue meetings as may be necessary.~~

~~(4) *Order of presentation for zoning matters and design review matters:* In order to avoid unnecessary project costs and delays, the board shall address and finalize each project zoning matter prior to initiating each project design review, to the extent applicable.~~

~~(35) *Location of all board meetings:* All board meetings shall be held in the Town Hall or Community Center.~~

Sec. 90-17. - Powers and duties.

(1) *Zoning matters*: The planning and zoning board shall act as an advisory board to the town commission on zoning matters and design review matters. The boards' powers and duties are as follows:

- (a) To perform its responsibilities as the local planning agency pursuant to local and state government comprehensive planning and land development regulations (F.S. Ch. 163);
 - (b) To review and make recommendations to the town manager and the town commission regarding the adopting and amendment of the official zoning map; the land development regulations amendments; zoning district boundary changes; and comprehensive plan amendments;
 - (c) To review and make recommendations to the town commission, on applications pertaining to site plans (if applicable) zoning changes, special use permits, conditional use variances vested rights and any other zoning applications;
 - (d) To conduct such studies and investigations required under the Town Code and/or requested by the town commission and as needed from time to time to sit in a joint session with the town commission as requested by the town commission; and
 - (e) The planning and zoning board shall have such other duties pertaining to zoning matters as prescribed by law, this section and the Town Code.
- (2) *Design Review* : The planning and zoning board shall conduct a design review for all structures to be constructed and renovated within town limits on the terms outlined below.
- (3) *FEMA review*: The planning and zoning board ~~when constituted as a design review board as set forth in section 90-18 herein below,~~ shall act as the variance and appeals board pursuant Chapter 42, "Floods," Division 6, Variance Procedures, sections 42-111 through 42-117.

Sec. 90-18. - Design Review, ~~Board.~~

- ~~(a) *Membership*. The planning and zoning board, when performing its design review and FEMA variance and appeals board functions shall be constituted as the design review board and shall have seven members. The seven members shall include the five members appointed by the town commission for the planning and zoning board and two additional members, at least one of the design review board members shall be a Florida-licensed architect or Florida-licensed landscape architect. The second design review board member shall be a Florida-licensed architect or a:~~
- ~~(1) Florida-licensed general contractor or a construction management professional with at least three years of professional experience as a construction project manager, construction superintendent or construction estimator;~~
 - ~~(2) Florida-licensed PE or a civil, mechanical, electrical, chemical or environmental engineer with a baccalaureate degree in engineering and three years of professional experience;~~
 - ~~(3) Certified planner (AICP) or a planning professional with a graduate degree in planning from a program accredited by the Planning Accreditation Board with at least three years of professional planning experience or a bachelor's degree in planning from a program, accredited by the Planning Accreditation Board (PAB) with at least three years of professional planning experience;~~

- ~~(4) Florida licensed landscape architect with at least three years of professional experience;~~
- ~~(5) Registered interior designer with at least three years of professional experience;~~
- ~~(6) Florida licensed attorney with at least three years of professional experience; or~~
- ~~(7) Real estate developer with three years of professional experience, either as the principal or executive.~~

~~Both of these members shall be appointed by a majority of the town commission. Four members present at the planning and zoning board design review meetings shall constitute a quorum and at least one of the four members shall be a design review board member.~~ The design review process is set forth as follows.

~~(ab)~~ *Design review process.*

(1) *Purpose.* This section is intended to promote excellence in architectural and urban design; preservation of the town's historic and architectural and neighborhood character; and desirable urban growth and development. To implement this goal, the ~~design review board is hereby created to review and make advisory recommendations to the~~ planning and zoning board ~~shall review and evaluate applications~~ as to whether the design of new developments and/or improvements within the town are consistent with and in conformance with the design guidelines set forth in the Town Code. The design guidelines are attached thereto as Exhibit A [at the end of this chapter] provided that the town commission may amend said guidelines from time to time via resolution. The guidelines as amended, shall govern and be applied as fully set forth herein.

(2) *Design review procedure:*

- a. All applications for new developments or improvements that are subject to the town's adopted design guidelines shall be referred to the planning and zoning board for review and consideration.
- b. The board shall review each application whether for development of single-family, multifamily, commercial or other districts for conformity with the town's adopted design guidelines and ~~recommend the application to the planning and zoning board for approval, approval~~ with conditions, or ~~disapproval of the design review~~ application. With regard to the design review process, no applicant shall be required to appear before the ~~design review~~ board more than twice per application.
- c. Meetings held by the board for review and recommendations of applications shall be arranged to permit participation by the person or group making the application or request and representatives of such person or group, if desired. Architectural plans and drawings of the building facades, lists of finish materials and other information necessary to provide adequate insight into the proposed development/improvement shall be provided to the board by the person or group making the proposal or request.
- ~~d. For design review applications that are not otherwise heard by the planning and zoning board, appeal of any design review board decision may be taken by an interested party to the town commission within 30 days of the hearing at which the design review board makes its final decision, by the filing of a notice of the appeal with the town commission. The appeal shall be heard as a quasi-judicial matter.~~

(3) Design review application fees are set forth in the town designated fee schedule.

(4) Design review applications which are made in conjunction with other development approval applications may be reviewed and considered concurrently with related development approval applications.

~~(4) All meetings of the design review board shall be publicly noticed.~~

Sec. 90-19. - Single-family and two-family development review process.

* * *

90-19.5 Design guidelines. The town has adopted design guidelines intended to provide direction and suggestions for all development. The purpose of the planning and zoning board when conducting design review ~~design review board~~ is to interpret those guidelines and provide guidance to the applicants as to how the design should be revised to more closely approximate or reflect the town's adopted guidelines. The applicant shall then incorporate those suggestions prior to proceeding to building permit.

90-19.6 Single-family and two-family development shall be reviewed by the planning and zoning board ~~design review board~~. The following types of applications shall require noticing as described below:

- (1) Construction of new single-family homes.
- (2) Partial demolition and rebuilding of at least 50 percent of the square footage of a single-family home where the exterior facade of the structure is affected.
- (3) An addition of at least 50 percent of the square footage of the existing single-family home.

The applicant shall notify the public of the planning and zoning board ~~design review board~~ hearing date and location, on the proposed application as follows:

- a. The applicant shall post a notice on the property one week prior to the planning and zoning board ~~design review board~~ meeting and remove the notice three days after the conclusion of the planning and zoning board ~~design review board~~ meeting. A notice, 18 inches by 24 inches, shall be placed in a prominent place on the property by the applicant, denoting the following:

REQUEST FOR: _____

PLANNING AND ZONING BOARD ~~DESIGN REVIEW BOARD~~ MEETING:

DATE AND TIME

TOWN HALL
9293 Harding Avenue
Surfside, FL 33154

COMPLETE INFORMATION REGARDING THE APPLICATION IS AVAILABLE BY CONTACTING THE TOWN HALL.

- b. The applicant shall mail written courtesy notices via certified mail, to the abutting single-family property owners and single-family property owners parallel to the

subject property line across any right-of-way, of the planning and zoning board ~~design review board~~ meeting date and location ten days prior to the meeting.

- c. The applicant shall provide the town the corresponding certified mail receipts, indicating the notices have been mailed and provide evidence that the sign has been posted three days prior to the planning and zoning board ~~design review board~~ meeting.

90-19.7 The following shall be exempt from planning and zoning board and ~~design-review board~~ review; however, the design guidelines shall be followed:

- (1) Interior or rear yard fences.
- (2) Interior renovations.
- (3) Single-family and two-family Awnings.
- (4) Screens.
- (5) Driveways.
- (6) Re-roofs
- (7) Trellis.
- (8) Rooftop photovoltaic solar systems.
- (9) Sheds.

90-19.8 The following are required for submittal to the planning and zoning board for design review applications ~~design review board~~:

* * *

90-19.9 *Effective period of* planning and zoning board design review ~~design review board~~ approval. An design review approval from the planning and zoning board ~~design review board~~ shall be effective until the development is completed except that if, after 24 months from the date of the approval by the planning and zoning board ~~design review board~~ a building permit for a principal building has not been issued and remains in effect, the approval shall be null and void.

- (1) Extensions for good cause, not to exceed a total of one year for all extensions, may be granted by the town commission, at its sole discretion, provided the applicant submits a request in writing to the town manager or designee in advance of the expiration of the original approval, setting forth good cause for such an extension. For the purpose of this Section, a building permit for a principal building shall cease to be in effect once required inspections have lapsed or once a certificate of completion or certificate of occupancy is issued.
- (2) All approvals which have been granted prior to the effective date of this chapter, shall be null and void and of no further force or effect if not utilized within two years after the effective date of this chapter, unless vested rights are demonstrated pursuant to subsection 90-5(11) of the zoning code. The foregoing provision of this paragraph shall not apply if the governmental resolution granting the approval expressly established a specific time limitation for utilizing the approval. In such instances, the time limitation established by such resolution shall prevail.

Sec. 90-20. - Development review requirements for submittals other than single-family and two-family.

- (1) Generally. Review and approval of a site plan by staff reviewing agencies, ~~the design review board,~~ and ~~the development impact committee,~~ the planning and zoning board, and the town commission is required prior to any development of land in the town.
- (2) Process. Submit plans (sets to be determined by town staff as appropriately needed), which are distributed to the staff members of the development review group (DRG).
 - (a) The DRG member shall review the site plan and prepare comments. The comments shall be forwarded to the town manager or designee. The comments shall be addressed by the applicant, if applicable. The town manager or designee shall hold a development review group meeting with appropriate town staff and the applicant to discuss the comments. In reviewing an application each reviewer shall consider, and comment as appropriate, on applicable issues relevant to their particular area of expertise, the extent to which:
 - i. The development, as proposed, conforms to the comprehensive plan and the zoning code;
 - ii. The development, as proposed, will have a favorable or unfavorable impact on the environment and natural resources, including a consideration of the means and estimated cost necessary to minimize the adverse impacts, if any;
 - iii. The development, as proposed, will have a favorable or unfavorable impact on the economy of the Town of Surfside;
 - iv. The development, as proposed, will efficiently use or unduly burden water, sewer, solid waste disposal, education, recreation or other necessary public facilities which have been constructed or planned and budgeted for construction in the area;
 - v. The development, as proposed, will efficiently use or unduly burden or affect public transportation facilities, including mass transit, public streets, and roads, which have been planned and budgeted for construction in the area, and if the development is or will be accessible by private or public roads or streets.
 - vi. The development, as proposed, is consistent with the community character of the immediate neighborhood. In addition to consistency there must be congruity between the subject development and neighboring improvements and surroundings including but not limited to form, spacing, heights, setbacks, materials, color, rhythm and pattern of architectural or aesthetic interest or value as well as with any overlays and other development schemes or legislation.
 - vii. In the event of redevelopment, the applicant shall also submit a detailed plan for demolition.
 - (b) After the revisions and upon review of the final site plan by the DRG members, the site plan will be scheduled for the next available ~~town design review board and planning and zoning board meetings.~~ If possible, the planning and zoning board meeting and the

~~design review board meeting should be held on the same date. The materials required under subsection 90-19.8 should not be duplicated for both the planning and zoning board meeting and design review board meeting. They shall be considered one submittal package. The Town Manager or designee shall prepare a report to the planning and zoning board and town commission, addressing the applicable criteria.~~

- (3) Submittal requirements for DRG, ~~and~~ planning and zoning board ~~and design review board~~ are provided below.

* * *

~~(4) Developmental impact committee.~~

- ~~(a) There is hereby established a developmental impact committee composed of seven members representing the following town departments and disciplines:~~

- ~~i. Town manager~~
- ~~ii. Town attorney~~
- ~~iii. Public works/landscape~~
- ~~iv. Planning and zoning~~
- ~~v. Park and recreation department~~
- ~~vi. Engineering and traffic engineering~~
- ~~vii. Building~~

- ~~(b) The developmental impact committee shall review all developments (except single family and two family homes) and recommend where applicable, whether, and the extent to which:~~

- ~~i. The development, as proposed, conforms to the comprehensive plan and the zoning code;~~
- ~~ii. The development, as proposed, will have a favorable or unfavorable impact on the environment and natural resources, including a consideration of the means and estimated cost necessary to minimize the adverse impacts, if any;~~
- ~~iii. The development, as proposed, will have a favorable or unfavorable impact on the economy of the Town of Surfside;~~
- ~~iv. The development, as proposed, will efficiently use or unduly burden water, sewer, solid waste disposal, education, recreation or other necessary public facilities which have been constructed or planned and budgeted for construction in the area;~~
- ~~v. The development, as proposed, will efficiently use or unduly burden or affect public transportation facilities, including mass transit, public streets, and roads, which have been planned and budgeted for construction in the area, and if the development is or will be accessible by private or public roads or streets.~~
- ~~vi. The development, as proposed, is consistent with the community character of the immediate neighborhood. In addition to consistency there must be congruity between the subject development and neighboring improvements and surroundings including but not limited to form, spacing, heights, setbacks, materials, color,~~

rhythm and pattern of architectural or aesthetic interest or value as well as with any overlays and other development schemes or legislation.

vii. In the event of redevelopment, applicant shall also submit a detailed plan for demolition.

(e) The committee shall meet prior to the planning and zoning board's hearing on the application. The committee shall be chaired by the town manager. The town manager or designee shall prepare a summary report of the development application to be distributed to and reviewed by the development impact committee prior to the committee meeting.

(d) The town manager or designee shall prepare a summary report of the results of the development impact committee to be transmitted to the planning and zoning board and town commission upon their review of the development application.

(e) The committee shall review and make recommendations pursuant to the criteria stated in (2) to the planning and zoning board and town commission whether, and to the extent to which, the development will efficiently use or unduly burden water, sewer, solid waste disposal, education, recreation or other necessary public facilities or public transportation facilities, including roads and streets, which have been constructed or planned and budgeted for construction in the area, and whether the proposed development will have a favorable or unfavorable impact on the economy of the Town of Surfside.

(f) No public hearing shall be held by any board on any application subject to review by the developmental impact committee until the committee has made its recommendations with regard thereto.

(g) Development impact committee meetings shall be noticed on the town website and shall be open to the public who may comment during a specific time scheduled on the agenda.

* * *

90-20.2 *Exempt development.* Notwithstanding any other provision of this chapter, the following activities shall not require site plan approval, however, may require design review board approval by the planning and zoning board:

- (1) The deposit and contouring of fill on land.
- (2) Construction of a single-family home on an existing single-family lot.
- (3) Construction of a single duplex on an existing single lot.

90-20.3 *Effective period of final site plan approval.* An approved final site plan shall be effective until the development is completed except that if, after 24 months from the date the final site plan is approved by the planning and zoning board a building permit for a principal building has not been issued and remains in effect, the site plan shall be null and void.

- (1) Extensions for good cause, not to exceed a total of one year for all extensions, may be granted by the town commission, at its sole discretion, provided the applicant submits a request in writing to the town manager or designee in advance of the expiration of the original approval, setting forth good cause for such an extension. For the purpose of this

section, a building permit for a principal building shall cease to be in effect once required inspections have lapsed or once a certificate of completion or certificate of occupancy is issued. In those cases where a development includes more than one principal building and it is contemplated that the development shown on a site plan will not be completed with a building permit for a principal building continuously in effect, approval by the planning and zoning board of a phasing schedule must be obtained as part of the overall site plan approval. Amendments to the original site plan shall not extend this time frame unless an extension is expressly granted by the planning and zoning board as a part of the approval of the amendment.

- (2) All approvals which have been granted prior to the effective date of this chapter, shall be null and void and of no further force or effect if not utilized within two years after the effective date of this chapter, unless vested rights are demonstrated pursuant to subsection 90-5(11) of the zoning code. The foregoing provision of this paragraph shall not apply if the governmental ~~resolution granting the~~ approval expressly established a specific time limitation for utilizing the approval. In such instances, the time limitation established by such resolution shall prevail.

* * *

Sec. 90-23. - Conditional uses.

90-23.1 Purpose. Conditional Uses are generally compatible with the other land uses permitted in a zoning district but, because of their unique characteristics or potential impacts on the surrounding neighborhood and the town as a whole, require individual review as to their location, design, configuration, and/or operation for the particular use at the particular location proposed, as well as the imposition of individualized conditions in order to ensure that the use is compatible with the surrounding neighborhoods and appropriate at a particular location.

90-23.2 Standards of review. In addition to the standards set forth in this zoning code for the particular use, all proposed conditional uses shall meet each of the following standards:

- (1) The proposed use shall be consistent with the Comprehensive Plan and the Zoning Code;
- (2) The establishment, maintenance or operation of the proposed use shall not be detrimental to or endanger the public health, safety, or general welfare;
- (3) The proposed use shall be compatible with the community character of the immediate neighborhood. In addition to compatibility there must be congruity between the subject development and neighboring improvements and surroundings including but not limited to form, spacing, heights, setbacks, materials, color, rhythm and pattern of architectural or aesthetic interest or value as well as with any overlays and other development schemes or legislation.
- (4) Adequate provisions shall be included for parking and safe traffic movement, both vehicular and pedestrian, both internal to the use and in the area which will serve the use;
- (5) Adequate measures exist including landscaping or other buffering measures or shall be taken to mitigate any adverse effects of noise, light or other potential nuisances; and

- (6) The establishment of the conditional use shall not impede the development of surrounding properties for uses permitted in the zoning district; and
- (7) Any other condition imposed by the planning and zoning design review board and/or the development impact committee.

* * *

DIVISION 2. - NONCONFORMING USES, LOTS AND STRUCTURES

* * *

Sec. 90-33. - Alterations or enlargement of nonconforming structures.

Except as provided in this section a nonconforming structure shall not be enlarged in any manner or undergo any structural alteration unless to make it a conforming structure. Such alteration or enlargement may be permitted provide that:

- (1) Enlargement or alteration itself conforms to the requirement of these regulations;
- (2) Building non-conformity only as to height area or floor area requirements may be altered or extended; enlarged so long as it does not increase the degree of non-conformity for the applicable district.
- (3) Alterations or additions to architecturally significant buildings on H120 zoned lots that are nonconforming as to setbacks may follow existing building lines as long as the alteration or addition maintains the architectural integrity of the existing building. The lesser of the current code-required setback or the existing building line shall be deemed to be the required setback line.

Any redevelopment project undertaken under this subsection must comply with the Town's minimum finished floor elevation requirements for all portions of the building and further must be designed and developed in accordance with Leadership in Energy & Environmental Design (LEED) or Florida Green Building Coalition (FGBC) building design and construction standards.

Redevelopment projects seeking to utilize the setback exception of this subsection shall be limited to a total height of no more than twice the number of existing floors in a building, up to a maximum of 120 feet.

Existing Building Floors	Maximum Number of Floors of Redevelopment/Expansion using Exception
1	2
2	4
3	6

4	8
5	10
6 and above	12

(a) Determinations of Architectural Significance. Determinations of architectural significance will be made as follows:

- (1) All requests for a determination of architectural significance must be made by a property owner in writing on the forms promulgated by the town. As part of the determination application, a property owner will submit an analysis of the architectural qualities of the existing structure prepared by a licensed architect, at the property owner's expense, demonstrating why the building is consistent with the Code's definition of an architecturally significant building. This analysis shall be accompanied with other materials deemed necessary by the town manager or designee to accommodate the review, including, but not limited to, all available data and documentation regarding the building, site, features, or other considerations by the town manager or designee.
- (2) The town manager or designee will review the analysis prepared by the property owner and issue a recommendation as to whether the building meets the town's standards of architectural significance. The property owner shall be responsible for the town's costs associated with this review, including the fees charged by any necessary consultants, such amounts shall be determined by the town manager or designee and held in escrow by the town.
- (3) Determinations of architectural significance will be made by the planning and zoning design review board, after public hearing, based on the following requirements.

* * *

(b) Alterations to Architecturally Significant Buildings. Any alteration proposed for a building on H120 zoned lots determined by the planning and zoning design review board to be architecturally significant will be reviewed by the Town Manager or his designee and the planning and zoning design review board to determine whether:

- i. The proposed alteration or addition does not require demolition or alteration in a manner that would render the building no longer architecturally significant; and
- ii. The proposed alteration or addition is designed in a manner that is compatible with the existing building.

(c) Site Plan Review for Architecturally Significant Buildings. Any addition requiring a site plan that is proposed for a building determined by the planning and zoning

design review board to be architecturally significant will be reviewed by the town manager or designee, ~~the design review board~~, the planning and zoning board, and the town commission to determine whether:

- i. The proposed alteration or addition does not require demolition or alteration in a manner that would render the building no longer architecturally significant; and
- ii. The proposed alteration or addition is designed in a manner that is compatible with the existing building.

Sec. 90-34. - Nonconforming uses not validated.

A nonconforming use in violation of a provision of these regulations, or any provision which these regulations amend or replace shall not be validated by the adoption of these regulations.

* * *

Sec. 90-49.2. - Awnings and canopies.

The following Design Criteria are applicable to all multi-dwelling and non-residential properties. All new and replacement awnings and canopies shall meet these requirements.

a. *Location/placement.*

* * *

b. *Appearance.*

1. Awnings shall be fabric or metal. Plastic and vinyl awnings are prohibited, except for First Grade vinyl awnings, subject to design review approval by the planning and zoning design review board.
2. Awnings shall be solid colors rather than patterned.
3. If an awning valance is proposed, it shall be straight rather than curved, except for special architectural elements to be compatible with historic building styles.
4. Awning colors shall enhance and complement the building and adjacent awnings, rather than overwhelm the building scheme. Colors shall not call more attention to the awning than the building.
5. Lighting associated with awnings and canopies shall be prohibited, except lighting approved by the planning and zoning design review board which is attached underneath the awning and intended to provide pedestrian lighting.
6. Signage, graphics and lettering shall be prohibited on canopies and awnings.

* * *

Sec. 90-50. - Architecture and roof decks.

90-50.1 Architecture.

- (1) Elevation and facade articulation variations.

- a. The architectural design of proposed main buildings shall create a unique elevation compared to the main buildings of the adjacent two buildings on each side of the subject property on the same side of street. If the adjacent lot is vacant then the next adjacent lot shall be utilized. A unique elevation shall be created through the modulation of at least three of the following architectural features:
 1. Length, width and massing of the structure;
 2. Number of stories;
 3. Facade materials;
 4. Porches and other similar articulation of the front facade;
 5. Number and location of doors and windows; and
 6. Roof style and pitch.
- (2) In the H30C, H40 and H120 districts: when more than one building is provided, buildings shall be designed in such a way that they are not monotonous.
- (3) All elevations for new structures and multi-story additions (additions greater than 15 feet in height) shall provide for a minimum of ten-percent wall openings including windows, doors or transitional spaces defined by porches, porticoes or colonnades per story.
- (4) All elevations for single story additions to existing structures shall result in a zero percent net loss of wall openings including windows, doors or transitional spaces defined by porches, porticoes or colonnades.
- (5) Roof materials are limited as follows:
 - a. Clay tile; or
 - b. White concrete tile; or
 - c. Solid color cement tile which color is impregnated with the same color intensity throughout, provided said color is granted design review approval by the planning and zoning design review board;
 - d. Architecturally embellished metal; or
 - e. Other Florida Building Code approved roof material(s) if granted design review approval by the planning and zoning design review board.
- (6) Garage facades. Attached garages located at the front of a single family home shall not exceed 50 percent of the overall length of the facade.
- (7) Converting single-family attached garages. When an attached garage is converted for any other use, the garage door or doors may be replaced by a solid exterior wall and access to the former garage area must be provided from the main premises, in addition to any other permitted access. At least one window shall be provided. If the garage entrance is located at the front or primary corner of the property, landscaping shall be provided along the base of the new exterior wall. When the installation of landscaping results in insufficient off-street parking, a landscaped planter shall be permitted in lieu of the required landscaping. It is intended hereby to prohibit and prevent any violation

of the single-family classification and to minimize the burden upon the administrative forces of the town in policing and enforcing the provisions hereof. Changes to the appearance of the residence shall not constitute a change prohibited by the "home office" provision of this Code. If the exterior door of the garage conversion is no longer level with grade, stairs may be installed and the exterior door must be accordingly corrected to comply with the Florida Building Code. The stairs shall be permitted to encroach no more than 24 inches into the side or rear setbacks.

- (8) Notwithstanding the foregoing, some of the architecture provisions in this section, while specific to zoning districts H30A and H30B, may also be applicable to single family homes in other zoning districts.
- (9) Paint colors. Structures in the H30A and H30B zoning districts shall be permitted to be painted the four lightest colors for the structure's primary color on the color swatch on file in the building department. All other colors may be accent colors. A paint swatch shall be submitted to the building department for approval by the town manager or designee. The planning and zoning design review board shall make a design determination in cases of uncertainty.

* * *

Sec. 90-54. - Accessory buildings and structures in the H30A and H30B districts.

* * *

90-54.8 All accessory buildings and structures, swimming pools, and accompanying fences and landscaping, located in the front yard setback shall be subject to review by the planning and zoning design review board.

* * *

Sec. 90-56. - Fences, walls and hedges.

* * *

90-56.2 A fence or ornamental wall may be placed within the front yard or primary corner yard if granted design review approval by the planning and zoning design review board.

* * *

90-56.9 Hedges shall be no more than four feet in height in the front yard and side corner yards and ten feet in height in the rear and interior side yards. Hedges may be higher if granted design review approval by the planning and zoning design review board, on a case-by-case basis.

* * *

Section 3. Severability. If any section, subsection, clause or provision of this Ordinance is declared invalid or unconstitutional by a court of competent jurisdiction, the remainder shall not be affected by such invalidity.

Section 4. Conflict. All sections or parts of sections of the Town of Surfside Code of Ordinances in conflict herewith are intended to be repealed to the extent of such conflict.

Section 5. Inclusion in the Code of Ordinances. It is the intention of the Town Commission, and it is hereby ordained that the provisions of this Ordinance shall become and made a part of the Town of Surfside Code of Ordinances, that the sections of this Ordinance may be renumbered or re-lettered to accomplish such intentions; and the word "Ordinance" may be changed to "Section" or other appropriate word.

Section 6. Effective Date. This Ordinance shall be effective upon final adoption on second reading.

PASSED on first reading this 14th day of August, 2018.

PASSED and **ADOPTED** on second reading this 12th day of September, 2018.

On Final Reading Moved by: Vice Mayor Gielchinsky

On Final Reading Second by: Commissioner Cohen

FINAL VOTE ON ADOPTION

Commissioner Barry Cohen	<u>yes</u>
Commissioner Michael Karukin	<u>NO</u>
Commissioner Tina Paul	<u>yes</u>
Vice Mayor Daniel Gielchinsky	<u>yes</u>
Mayor Daniel Dietch	<u>yes</u>



Daniel Dietch, Mayor

ATTEST:



Sandra Novoa, MMC, Town Clerk

**APPROVED AS TO FORM AND LEGALITY FOR THE USE
AND BENEFIT OF THE TOWN OF SURFSIDE ONLY:**

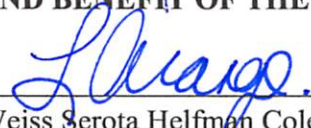

Weiss Serota Helfman Cole & Bierman, P.L.,
Town Attorney



MEMORANDUM

ITEM NO. **4Y**

To: Honorable Mayor, Vice-Mayor and Members of the Town Commission
From: Guillermo Olmedillo, Town Manager
Date: April 16, 2020
Subject: Weiss Serota Contract Follow up

At the March 24, 2020 Special Commission Meeting, Town Administration was directed to provide a report on the expenditures related to the Weiss Serota Town Attorney contract for the period of January 2019 through December 2019.

Please find attached requested report. Th report was provided to Commission on April 7, 2020.

Reviewed by: LA

Prepared by: JDG



Town of Surfside, Florida

My Vendor History Report

By Vendor Name

Posting Date Range 01/01/2019 - 12/31/2019

Payment Date Range -

Payable Number	Description	Units	Price	Post Date	1099	Payment Number	Payment Date	Amount	Shipping	Tax	Discount	Net	Payment
Item Description				Amount	Account Number	Account Name		Dist	Amount				
1067 - WEISS SEROTA HELFMAN COLE	SEP-19 PARTICIPATION OF COAL OF CITIES F19/30/2019	0.00	0.00	1,923.08	Y	112423	1/22/2020	485,923.86	0.00	0.00	0.00	485,923.86	485,923.86
12345	SEP-19 PARTICIPATION O	0.00	0.00	1,923.08	001-1500-514-31-10	PROFESSIONAL SERVICES		1,923.08	0.00	0.00	0.00	1,923.08	1,923.08
212256	LEGAL FEES DECEMBER 2018 12/1/2018-12/31/28/2019	0.00	0.00	2,596.52	Y	109435	2/22/2019	2,596.52	0.00	0.00	0.00	2,596.52	2,596.52
212257	LEGAL FEES DECEMBER 21	0.00	0.00	2,596.52	001-1500-514-31-10	PROFESSIONAL SERVICES		2,596.52	0.00	0.00	0.00	2,596.52	2,596.52
212258	LEGAL FEES 12/1/18-12/31/2018	0.00	0.00	29,653.84	Y	109435	2/22/2019	29,653.84	0.00	0.00	0.00	29,653.84	29,653.84
212258	LEGAL DECEMBER 12/1/18-12/31/2018	0.00	0.00	29,653.84	001-1500-514-31-10	PROFESSIONAL SERVICES		29,653.84	0.00	0.00	0.00	29,653.84	29,653.84
212259	LEGAL DECEMBER 12/1/1	0.00	0.00	125.00	001-220-90-10	COST RECOVERY		125.00	0.00	0.00	0.00	125.00	125.00
212259	LEGAL FEES DECEMBER 12/1/2018-12/31/20/1/28/2019	0.00	0.00	125.00	Y	109435	2/22/2019	125.00	0.00	0.00	0.00	125.00	125.00
212260	LEGAL FEES DECEMBER 1	0.00	0.00	125.00	001-220-90-10	COST RECOVERY		125.00	0.00	0.00	0.00	125.00	125.00
212260	LEGAL FEES DECEMBER 2018 12/1/2018-12/31/28/2019	0.00	0.00	6,267.29	Y	109435	2/22/2019	6,267.29	0.00	0.00	0.00	6,267.29	6,267.29
212261	LEGAL FEES DECEMBER 21	0.00	0.00	6,267.29	001-1500-514-31-10	PROFESSIONAL SERVICES		6,267.29	0.00	0.00	0.00	6,267.29	6,267.29
212261	LEGAL FEES DECEMBER 12/1/2018-12/31/20/1/28/2019	0.00	0.00	482.50	Y	109435	2/22/2019	482.50	0.00	0.00	0.00	482.50	482.50
212261	LEGAL FEES DECEMBER 1	0.00	0.00	482.50	001-1500-514-31-10	PROFESSIONAL SERVICES		482.50	0.00	0.00	0.00	482.50	482.50
213421	LEGAL FEES FOR JANUARY 2019	0.00	0.00	858.00	Y	109833	4/8/2019	858.00	0.00	0.00	0.00	858.00	858.00
213421	LEGAL FEES FOR JANUARY	0.00	0.00	858.00	001-1500-514-31-10	PROFESSIONAL SERVICES		858.00	0.00	0.00	0.00	858.00	858.00
213422	LEGAL FEES FOR JANUARY 2019	0.00	0.00	1,225.00	Y	109833	4/8/2019	1,225.00	0.00	0.00	0.00	1,225.00	1,225.00
213422	LEGAL FEES FOR JANUARY	0.00	0.00	1,225.00	001-1500-514-31-10	PROFESSIONAL SERVICES		1,225.00	0.00	0.00	0.00	1,225.00	1,225.00
213423	LEGAL FEES JANUARY 2019	0.00	0.00	29,660.22	Y	109833	4/8/2019	29,660.22	0.00	0.00	0.00	29,660.22	29,660.22
213423	LEGAL FEES JANUARY 201	0.00	0.00	29,660.22	001-1500-514-31-10	PROFESSIONAL SERVICES		29,660.22	0.00	0.00	0.00	29,660.22	29,660.22
213424	LEGAL FEES FOR JANUARY 2019	0.00	0.00	125.00	Y	109833	4/8/2019	125.00	0.00	0.00	0.00	125.00	125.00
213424	LEGAL FEES FOR JANUARY	0.00	0.00	125.00	001-220-90-10	COST RECOVERY		125.00	0.00	0.00	0.00	125.00	125.00
213425	LEGAL FEES FOR JANUARY 2019	0.00	0.00	1,533.00	Y	109833	4/8/2019	1,533.00	0.00	0.00	0.00	1,533.00	1,533.00
213425	LEGAL FEES FOR JANUARY	0.00	0.00	1,533.00	001-1500-514-31-10	PROFESSIONAL SERVICES		1,533.00	0.00	0.00	0.00	1,533.00	1,533.00
213426	LEGAL FEES FOR JANUARY 2019	0.00	0.00	250.00	Y	109833	4/8/2019	250.00	0.00	0.00	0.00	250.00	250.00
213426	LEGAL FEES FOR JANUARY	0.00	0.00	250.00	001-220-90-10	COST RECOVERY		250.00	0.00	0.00	0.00	250.00	250.00
213427	LEGAL FEES FOR JANUARY 2019	0.00	0.00	1,625.00	Y	109833	4/8/2019	1,625.00	0.00	0.00	0.00	1,625.00	1,625.00
213427	LEGAL FEES FOR JANUARY	0.00	0.00	1,625.00	001-1500-514-31-10	PROFESSIONAL SERVICES		1,625.00	0.00	0.00	0.00	1,625.00	1,625.00
213905	LEGAL FEES FEBRUARY 2019	0.00	0.00	2,273.50	Y	109833	4/8/2019	2,273.50	0.00	0.00	0.00	2,273.50	2,273.50
213905	LEGAL FEES FEBRUARY 2C	0.00	0.00	2,273.50	001-1500-514-31-10	PROFESSIONAL SERVICES		2,273.50	0.00	0.00	0.00	2,273.50	2,273.50

My Vendor History Report

Posting Date Range 01/01/2019 - 12/31/2019

Payable Number	Description	Units	Price	Amount	Post Date	1099 Account Number	Payment Number	Account Name	Payment Date	Amount	Shipping Dist Amount	Tax	Discount	Net	Payment
213906	LEGAL FEES FEBRUARY 2019	0.00	0.00	50.00	3/18/2019	Y 109833		PROFESSIONAL SERVICES	4/8/2019	50.00	0.00	0.00	0.00	50.00	50.00
213908	LEGAL FEES FOR FEBRUARY 2019	0.00	0.00	29,655.06	3/18/2019	Y 109833		PROFESSIONAL SERVICES	4/8/2019	29,655.06	29,655.06	0.00	0.00	29,655.06	29,655.06
213909	LEGAL FEES FEBRUARY 2019	0.00	0.00	6,200.00	3/18/2019	Y 109833		COST RECOVERY	4/8/2019	6,200.00	6,200.00	0.00	0.00	6,200.00	6,200.00
213910	LEGAL FEES FEBRUARY 2019	0.00	0.00	383.00	3/18/2019	Y 109833		PROFESSIONAL SERVICES	4/8/2019	383.00	383.00	0.00	0.00	383.00	383.00
213911	LEGAL FEES FEBRUARY 2019	0.00	0.00	4,175.00	3/18/2019	Y 109833		PROFESSIONAL SERVICES	4/8/2019	4,175.00	4,175.00	0.00	0.00	4,175.00	4,175.00
215204	LEGAL FEES FOR FEB. 2019 /PERIOD 3/01/19-4/16/2019	0.00	0.00	913.70	3/01/19-4/16/2019	Y 110114		PROFESSIONAL SERVICES	5/6/2019	913.70	913.70	0.00	0.00	913.70	913.70
215205	LEGAL FEES FOR FEB 2019/PERIOD 3/1/19-3/4/16/2019	0.00	0.00	2,395.65	3/1/19-3/4/16/2019	Y 110114		PROFESSIONAL SERVICES	5/6/2019	2,395.65	2,395.65	0.00	0.00	2,395.65	2,395.65
215206	LEGAL FEES FOR FEB 2019/PERIOD 3/1/19-3/4/16/2019	0.00	0.00	29,656.30	3/1/19-3/4/16/2019	Y 110114		PROFESSIONAL SERVICES	5/6/2019	29,656.30	29,656.30	0.00	0.00	29,656.30	29,656.30
215207	LEGAL FEES FOR FEB 2019/PERIOD 3/1/19-3/4/16/2019	0.00	0.00	475.00	3/1/19-3/4/16/2019	Y 110114		COST RECOVERY	5/6/2019	475.00	475.00	0.00	0.00	475.00	475.00
215208	LEGAL FEES FOR FEB 2019/PERIOD 3/1/19-3/4/16/2019	0.00	0.00	1,300.00	3/1/19-3/4/16/2019	Y 110114		COST RECOVERY	5/6/2019	1,300.00	1,300.00	0.00	0.00	1,300.00	1,300.00
215209	LEGAL FEES FOR FEB 2019/PERIOD 3/1/19-3/4/16/2019	0.00	0.00	3,909.00	3/1/19-3/4/16/2019	Y 110114		PROFESSIONAL SERVICES	5/6/2019	3,909.00	3,909.00	0.00	0.00	3,909.00	3,909.00
215210	LEGAL FEES FOR FEB 2019/PERIOD 3/1/19-3/4/16/2019	0.00	0.00	297.00	3/1/19-3/4/16/2019	Y 110114		PROFESSIONAL SERVICES	5/6/2019	297.00	297.00	0.00	0.00	297.00	297.00
215211	LEGAL FEES FOR FEB 2019/PERIOD 3/1/19-3/4/16/2019	0.00	0.00	375.00	3/1/19-3/4/16/2019	Y 110114		PROFESSIONAL SERVICES	5/6/2019	375.00	375.00	0.00	0.00	375.00	375.00
216027	LEGAL FEES APRIL 1-30, 2019	0.00	0.00	3,736.50	5/14/2019	Y 110380		PROFESSIONAL SERVICES	6/4/2019	3,736.50	3,736.50	0.00	0.00	3,736.50	3,736.50
216028	LEGAL FEES APRIL 1-30, 2019	0.00	0.00	1,311.50	5/14/2019	Y 110380		PROFESSIONAL SERVICES	6/4/2019	1,311.50	1,311.50	0.00	0.00	1,311.50	1,311.50
216029	LEGAL FEES APRIL 1-30, 2019	0.00	0.00	29,615.66	5/14/2019	Y 110380		PROFESSIONAL SERVICES	6/4/2019	29,615.66	29,615.66	0.00	0.00	29,615.66	29,615.66
216030	LEGAL FEES APRIL 1-30, 2019	0.00	0.00	1,075.00	5/14/2019	Y 110380		COST RECOVERY	6/4/2019	1,075.00	1,075.00	0.00	0.00	1,075.00	1,075.00
216031	LEGAL FEES APRIL 1-30, 2019	0.00	0.00	1,200.00	5/14/2019	Y 110380		COST RECOVERY	6/4/2019	1,200.00	1,200.00	0.00	0.00	1,200.00	1,200.00
216032	LEGAL FEES APRIL 1-30, 2019	0.00	0.00	925.00	5/14/2019	Y 110380		COST RECOVERY	6/4/2019	925.00	925.00	0.00	0.00	925.00	925.00

My Vendor History Report

Posting Date Range 01/01/2019 - 12/31/2019

Payable Number	Description	Units	Price	Amount	Post Date	1099 Account Number	Payment Number	Account Name	Payment Date	Amount	Shipping Dist Amount	Tax	Discount	Net	Payment
216033	LEGAL FEES APRIL 1-30, 2	0.00	0.00	925.00	5/14/2019	001-1500-514-31-10	Y 110380	PROFESSIONAL SERVICES	6/4/2019	7,014.47	925.00	0.00	0.00	7,014.47	7,014.47
216034	LEGAL FEES APRIL 1-30, 2	0.00	0.00	5,948.00	5/14/2019	001-1500-514-31-10	Y 110380	PROFESSIONAL SERVICES	6/4/2019	5,948.00	0.00	0.00	0.00	5,948.00	5,948.00
217140	LEGAL FEES FOR MAY 201	0.00	0.00	1,066.47	6/19/2019	001-1500-514-31-10	Y 110844	PROFESSIONAL SERVICES	7/26/2019	1,066.47	0.00	0.00	0.00	1,066.47	1,066.47
217141	LEGAL FEES FOR MAY 201	0.00	0.00	575.00	6/19/2019	001-1500-514-31-10	Y 110844	PROFESSIONAL SERVICES	7/26/2019	575.00	575.00	0.00	0.00	575.00	575.00
217142	LEGAL FEES FOR MAY 201	0.00	0.00	50.00	6/19/2019	001-1500-514-31-10	Y 110844	PROFESSIONAL SERVICES	7/26/2019	50.00	50.00	0.00	0.00	50.00	50.00
217143	LEGAL FEES FOR MAY 201	0.00	0.00	4,207.72	6/19/2019	001-1500-514-31-10	Y 110844	PROFESSIONAL SERVICES	7/26/2019	4,207.72	4,207.72	0.00	0.00	4,207.72	4,207.72
217144	LEGAL FEES FOR MAY 201	0.00	0.00	2,250.00	6/19/2019	001-1500-514-31-10	Y 110844	PROFESSIONAL SERVICES	7/26/2019	2,250.00	2,250.00	0.00	0.00	2,250.00	2,250.00
217145	LEGAL FEES FOR MAY 201	0.00	0.00	12.00	6/19/2019	001-1500-514-31-10	Y 110844	PROFESSIONAL SERVICES	7/26/2019	12.00	12.00	0.00	0.00	12.00	12.00
217146	LEGAL FEES FOR MAY 201	0.00	0.00	29,612.50	6/19/2019	001-1500-514-31-10	Y 110844	PROFESSIONAL SERVICES	7/26/2019	29,612.50	29,612.50	0.00	0.00	29,612.50	29,612.50
217147	LEGAL FEES FOR MAY 201	0.00	0.00	1,675.00	6/19/2019	001-220-90-10	Y 111192	COST RECOVERY	7/26/2019	1,675.00	1,675.00	0.00	0.00	1,675.00	1,675.00
217149	LEGAL FEES FOR MAY 201	0.00	0.00	1,145.50	6/19/2019	001-1500-514-31-10	Y 110844	PROFESSIONAL SERVICES	7/26/2019	1,145.50	1,145.50	0.00	0.00	1,145.50	1,145.50
218462	LEGAL FEES FOR JUNE 20	0.00	0.00	575.00	6/19/2019	001-1500-514-31-10	Y 110844	PROFESSIONAL SERVICES	7/26/2019	575.00	575.00	0.00	0.00	575.00	575.00
218463	LEGAL FEES FOR JUNE 20	0.00	0.00	221.30	6/30/20	001-1500-514-31-10	Y 111192	PROFESSIONAL SERVICES	9/6/2019	221.30	221.30	0.00	0.00	221.30	221.30
218464	LEGAL FEES FOR JUNE 20	0.00	0.00	272.00	6/30/20	001-1500-514-31-10	Y 111192	PROFESSIONAL SERVICES	9/6/2019	272.00	272.00	0.00	0.00	272.00	272.00
218465	LEGAL FEES FOR JUNE 20	0.00	0.00	1,000.00	6/30/20	001-1500-514-31-10	Y 111192	PROFESSIONAL SERVICES	9/6/2019	1,000.00	1,000.00	0.00	0.00	1,000.00	1,000.00
218466	LEGAL FEES FOR JUNE 20	0.00	0.00	29,612.50	6/1/19 - 6/30/20	001-1500-514-31-10	Y 111192	RETAINER SERVICES	9/6/2019	29,612.50	29,612.50	0.00	0.00	29,612.50	29,612.50
218467	LEGAL FEES FOR JUNE 20	0.00	0.00	375.00	6/1/19 - 6/30/20	001-220-90-10	Y 111192	COST RECOVERY	9/6/2019	375.00	375.00	0.00	0.00	375.00	375.00
218468	LEGAL FEES FOR JUNE 20	0.00	0.00	750.50	6/1/19 - 6/30/20	001-1500-514-31-10	Y 111192	PROFESSIONAL SERVICES	9/6/2019	750.50	750.50	0.00	0.00	750.50	750.50
218469	LEGAL FEES FOR JUNE 20	0.00	0.00	575.00	6/1/19 - 6/30/20	001-1500-514-31-10	Y 111192	PROFESSIONAL SERVICES	9/6/2019	575.00	575.00	0.00	0.00	575.00	575.00
218469	LEGAL FEES FOR JUNE 20	0.00	0.00	840.00	6/1/19 - 6/30/20	Y 111192	Y 111192	PROFESSIONAL SERVICES	9/6/2019	840.00	840.00	0.00	0.00	840.00	840.00

My Vendor History Report

Posting Date Range 01/01/2019 - 12/31/2019

Payable Number	Description	Units	Price	Amount	Post Date	1099 Account Number	Payment Number	Account Name	Payment Date	Amount	Shipping Dist Amount	Tax	Discount	Net	Payment
219594	LEGAL FEES FOR JUNE 2019	0.00	0.00	840.00	8/29/2019	001-1500-514-31-10		PROFESSIONAL SERVICES	9/19/2019	1,057.90	840.00	0.00	0.00	1,057.90	1,057.90
219595	GENERAL LABOR 07/2019	0.00	0.00	1,057.90	8/29/2019	001-1500-514-31-10	Y 111309	PROFESSIONAL SERVICES	9/19/2019	1,057.90	1,057.90	0.00	0.00	1,057.90	1,057.90
219596	POLICE MATTERS 07/2019	0.00	0.00	129.00	8/29/2019	001-1500-514-31-10	Y 111309	PROFESSIONAL SERVICES	9/19/2019	129.00	129.00	0.00	0.00	129.00	129.00
219597	MONTHLY RETAINER 7/2019	0.00	0.00	29,634.00	8/29/2019	001-1500-514-31-10	Y 111309	PROFESSIONAL SERVICES	9/19/2019	29,634.00	29,634.00	0.00	0.00	29,634.00	29,634.00
219598	LAND USE RECOVER - EDEN	0.00	0.00	450.00	8/29/2019	001-220-90-10	Y 111309	COST RECOVERY	9/19/2019	450.00	450.00	0.00	0.00	450.00	450.00
219599	LEGAL FEE FOR JULY 2019 PERIOD 7/1/2019-8/29/2019	0.00	0.00	4,266.50	8/29/2019	001-1500-514-31-10	Y 111309	PROFESSIONAL SERVICES	9/19/2019	4,266.50	4,266.50	0.00	0.00	4,266.50	4,266.50
219600	SUSTAINABILITY & RESILIENCY COMMITTEE 7/2019	0.00	0.00	537.50	8/29/2019	001-1500-514-31-10	Y 111309	PROFESSIONAL SERVICES	9/19/2019	537.50	537.50	0.00	0.00	537.50	537.50
219601	SURF CLUB 7/2019	0.00	0.00	200.00	8/29/2019	001-1500-514-31-10	Y 111309	PROFESSIONAL SERVICES	9/19/2019	200.00	200.00	0.00	0.00	200.00	200.00
219879	POLICE MATTERS 7/2019	0.00	0.00	3,436.00	9/12/2019	001-1500-514-31-10	Y 111309	PROFESSIONAL SERVICES	9/19/2019	3,436.00	3,436.00	0.00	0.00	3,436.00	3,436.00
220398	PROFESSIONAL SERVICES RENDERED AUG-19 9/17/2019	0.00	0.00	2,986.20	9/17/2019	001-1500-514-31-10	Y 111432	PROFESSIONAL SERVICES	9/30/2019	2,986.20	2,986.20	0.00	0.00	2,986.20	2,986.20
220399	POLICE MATTERS AUG-19	0.00	0.00	228.60	9/17/2019	001-1500-514-31-10	Y 111432	PROFESSIONAL SERVICES	9/30/2019	228.60	228.60	0.00	0.00	228.60	228.60
220400	PROFESSIONAL SERVICES FOR CODE ENFORC/9/17/2019	0.00	0.00	1,182.50	9/17/2019	001-1500-514-31-10	Y 111432	PROFESSIONAL SERVICES	9/30/2019	1,182.50	1,182.50	0.00	0.00	1,182.50	1,182.50
220401	MONTHLY RETAINER FOR LEGAL SERVICES AL 9/17/2019	0.00	0.00	29,770.12	9/17/2019	001-1500-514-31-10	Y 111432	PROFESSIONAL SERVICES	9/30/2019	29,770.12	29,770.12	0.00	0.00	29,770.12	29,770.12
220402	LAND USE COST REC. YOUNG ISRAEL-ADA RAM 9/30/2019	0.00	0.00	3,700.00	9/30/2019	001-220-90-10	Y 111432	COST RECOVERY	9/30/2019	3,700.00	3,700.00	0.00	0.00	3,700.00	3,700.00
220403	LAND USE COST RECOVER. KRIEG, DAVID & BELLA 9/17/2019	0.00	0.00	930.00	9/17/2019	001-220-90-10	Y 111432	COST RECOVERY	9/30/2019	930.00	930.00	0.00	0.00	930.00	930.00
220404	LAND USE COST RECOVER. EDEN SURFSIDE AUG 9/17/2019	0.00	0.00	250.00	9/17/2019	001-220-90-10	Y 111432	COST RECOVERY	9/30/2019	250.00	250.00	0.00	0.00	250.00	250.00
220405	SPECIAL PROJECTS	0.00	0.00	450.00	9/17/2019	001-1500-514-31-10	Y 111432	PROFESSIONAL SERVICES	9/30/2019	450.00	450.00	0.00	0.00	450.00	450.00
220406	LITIGATION	0.00	0.00	3,276.00	9/17/2019	001-1500-514-31-10	Y 111432	PROFESSIONAL SERVICES	9/30/2019	3,276.00	3,276.00	0.00	0.00	3,276.00	3,276.00
220407	SOLIMAR COND-CHALLENGE UTI. FEES LITIG 9/17/2019	0.00	0.00	5,640.00	9/17/2019	001-1500-514-31-10	Y 111432	PROFESSIONAL SERVICES	9/30/2019	5,640.00	5,640.00	0.00	0.00	5,640.00	5,640.00

My Vendor History Report

Posting Date Range 01/01/2019 - 12/31/2019

Payable Number	Description	Units	Price	Amount	Post Date	1099 Account Number	Payment Number	Account Name	Payment Date	Amount	Shipping Dist Amount	Tax	Discount	Net	Payment
2220408	PREPARATION OF RESPONSE TO AUDIT LETTE	0.00	0.00	250.00	9/30/2019	001-1500-514-31-10	Y 111432	PROFESSIONAL SERVICES	9/30/2019	250.00	0.00	0.00	0.00	250.00	250.00
221976	SEPT-19 PROFESSIONAL SERVICES	0.00	0.00	2,043.50	9/30/2019	001-1500-514-31-10	Y 112048	PROFESSIONAL SERVICES	12/9/2019	2,043.50	0.00	0.00	0.00	2,043.50	2,043.50
221977	SEP-19 POLICE MATTERS	0.00	0.00	4,601.25	9/30/2019	001-1500-514-31-10	Y 112048	PROFESSIONAL SERVICES	12/9/2019	4,601.25	0.00	0.00	0.00	4,601.25	4,601.25
221978	SEPT-19 MONTHLY RETAINER	0.00	0.00	29,676.58	9/30/2019	001-1500-514-31-10	Y 112048	PROFESSIONAL SERVICES	12/9/2019	29,676.58	0.00	0.00	0.00	29,676.58	29,676.58
221979	SEPT-19 COST RECOVERY 8995 COLLINS AVE.	0.00	0.00	430.00	9/30/2019	001-1500-514-31-10	Y 112048	COST RECOVERY	12/9/2019	430.00	0.00	0.00	0.00	430.00	430.00
221980	SEPT-19 COST RECOVERY 9300-9380 COLLINS	0.00	0.00	1,000.00	9/30/2019	001-220-90-10	Y 112048	COST RECOVERY	12/9/2019	1,000.00	0.00	0.00	0.00	1,000.00	1,000.00
221981	SEPT-19 LITIGATION	0.00	0.00	939.50	9/30/2019	001-1500-514-31-10	Y 112048	PROFESSIONAL SERVICES	12/9/2019	939.50	0.00	0.00	0.00	939.50	939.50
221982	SEPT-19 SOLIMAR CONDO STORMWATER FEE	0.00	0.00	150.00	9/30/2019	001-1500-514-31-10	Y 112048	PROFESSIONAL SERVICES	12/9/2019	150.00	0.00	0.00	0.00	150.00	150.00
222955	OCT-19 PROFESSIONAL SERVICES	0.00	0.00	3,086.50	12/5/2019	001-1500-514-31-10	Y 112127	PROFESSIONAL SERVICES	12/18/2019	3,086.50	0.00	0.00	0.00	3,086.50	3,086.50
222956	OCT-19 POLICE MATTERS	0.00	0.00	135.95	12/5/2019	001-1500-514-31-10	Y 112127	PROFESSIONAL SERVICES	12/18/2019	135.95	0.00	0.00	0.00	135.95	135.95
222957	OCT-19 MONTHLY RETAINER	0.00	0.00	29,702.95	12/5/2019	001-1500-514-31-10	Y 112127	PROFESSIONAL SERVICES	12/18/2019	29,702.95	0.00	0.00	0.00	29,702.95	29,702.95
222958	OCT-19 LAND USE COST RECOV. YOUNG ISR	0.00	0.00	1,525.00	12/5/2019	001-220-90-10	Y 112127	COST RECOVERY	12/18/2019	1,525.00	0.00	0.00	0.00	1,525.00	1,525.00
222959	OCT-19 LAND USE RECOVERY KRIGER, VARIA	0.00	0.00	850.00	12/5/2019	001-220-90-10	Y 112127	COST RECOVERY	12/18/2019	850.00	0.00	0.00	0.00	850.00	850.00
222960	OCT-19 LAND USE COST RECOV. SAMUEL FR	0.00	0.00	675.00	12/5/2019	001-220-90-10	Y 112127	COST RECOVERY	12/18/2019	675.00	0.00	0.00	0.00	675.00	675.00
222961	OCT-19 LAND USE COST RECOV. 8995 COLLIN	0.00	0.00	450.00	12/13/2019	001-220-90-10	Y 112127	COST RECOVERY	12/18/2019	450.00	0.00	0.00	0.00	450.00	450.00
222962	OCT-19 PROFESSIONAL SERVICES LITIGATION	0.00	0.00	2,529.50	12/5/2019	001-1500-514-31-10	Y 112127	PROFESSIONAL SERVICES	12/18/2019	2,529.50	0.00	0.00	0.00	2,529.50	2,529.50
222963	OCT-19 SPECIAL LITIGATION SOLIMAR CONDO	0.00	0.00	7,650.50	12/5/2019	001-1500-514-31-10	Y 112127	PROFESSIONAL SERVICES	12/18/2019	7,650.50	0.00	0.00	0.00	7,650.50	7,650.50
223550	NOV-19 PROFESSIONAL SERVICES	0.00	0.00	1,604.00	12/12/2019	001-1500-514-31-10	Y 112198	PROFESSIONAL SERVICES	12/23/2019	1,604.00	0.00	0.00	0.00	1,604.00	1,604.00
223551	NOV-19 POLICE MATTERS	0.00	0.00	1,934.50	12/12/2019	001-1500-514-31-10	Y 112198	PROFESSIONAL SERVICES	12/23/2019	1,934.50	0.00	0.00	0.00	1,934.50	1,934.50

My Vendor History Report

Posting Date Range 01/01/2019 - 12/31/2019

Payable Number	Description	Units	Price	Amount	Post Date	1099 Account Number	Payment Number	Account Name	Payment Date	Amount	Shipping	Tax	Discount	Net	Payment
223552	NOV-19 POLICE MATTERS	0.00	0.00	1,934.50	12/12/2019	001-1500-514-31-10		PROFESSIONAL SERVICES	12/23/2019	29,612.50	0.00	0.00	0.00	29,612.50	29,612.50
223553	NOV-19 MONTHLY RETAINER	0.00	0.00	29,612.50	12/12/2019	001-1500-514-31-10		PROFESSIONAL SERVICES	12/23/2019	725.00	0.00	0.00	0.00	725.00	725.00
223554	NOV-19 PROFFESIONAL S	0.00	0.00	725.00	12/12/2019	001-1500-514-31-10		PROFESSIONAL SERVICES	12/23/2019	1,042.50	0.00	0.00	0.00	1,042.50	1,042.50
INV213906	DEC-19 SPECIAL LITIGATION SOLIMAR UTILIT	0.00	0.00	1,042.50	12/12/2019	001-1500-514-31-10		PROFESSIONAL SERVICES	4/8/2019	50.00	0.00	0.00	0.00	50.00	50.00
	LEGAL FEES FEBRUARY 2019	0.00	0.00	50.00	3/18/2019	001-1500-514-31-10		PROFESSIONAL SERVICES		50.00	0.00	0.00	0.00	50.00	50.00
	LEGAL FEES FEBRUARY 20	0.00	0.00	50.00	3/18/2019	001-1500-514-31-10		PROFESSIONAL SERVICES		50.00	0.00	0.00	0.00	50.00	50.00
Vendors: (1) Total 01 - Vendor Set 01:										485,923.86	0.00	0.00	0.00	485,923.86	485,923.86
Vendors: (1) Report Total:										485,923.86	0.00	0.00	0.00	485,923.86	485,923.86



MEMORANDUM

To: Honorable Mayor, Vice-Mayor and Members of the Town Commission
From: Guillermo Olmedillo, Town Manager
Date: April 15, 2020
Subject: Town Pension Benefits for Non-Public Safety Employees

Pursuant to the April 16, 2020 Town Commission agenda item regarding the Town pension benefits for non-public safety employees, enacted changes are as follows:

On September 13, 2016 the Town Commission approved pension amendments for general employees (non-sworn) that increased the employee contributions and improved benefits effective October 1, 2016 as follows:

- **Increased general employee contribution by 2%.**
General employee contribution increased from 6% to 8%; one grandfathered employee 5% to 7%;
- **Increased the benefit cap from 60% to 68%.**
The benefit cap at 60% was one of the lowest in the State of Florida amongst defined benefit plans.
The benefit cap for police officers (sworn group) is 90%;
- **Increased the multiplier from 2 % to 2.65% for the one grandfathered employee and from 2.5% to 2.8% for all other general employees (non-sworn).**
The multiplier for police officers (sworn group) is 3.5%;
- **A senior management class be established** consistent of all Department Directors and Assistant Town Manager.
Excluded from this class is the Police Chief, Town Manager and Town Attorney (if employed by the Town);
- **The senior management's multiplier increased from 2.5% to 3%** (rather than the 2.8% as other general employees);

- **The senior management cap increased to 80%** (rather than the 68%); and
- **The Town Attorney vesting requirements were lowered** from 10 years to 7 years to match the vesting requirements of the Town Manager.

An actuarial study was conducted. The above changes were cost neutral. The incremental cost to the Town's annual contribution would increase by \$905 or 0% of payroll, the employees covered the cost with the 2% increase of their contributions and the \$905 was primarily the cost to cover the Town Attorney changes.

Please see below table taken from Actuarial Impact Statement, dated September 6, 2016.

	Incremental Cost in Net Town Annual Required Contribution	Incremental Cost in Employee Annual Contribution
Proposed Amendment for General Employees	(\$4,828) (0.2%) of payroll	\$43,050 1.4% of payroll
Proposed Amendment for Senior Management Employees	\$4,483 0.1% of payroll	\$19,376 0.6% of payroll
Proposed Amendment for Town Attorney	\$1,250 0% of payroll	\$0 0% of payroll
Combined Effect	\$905 0% of payroll	\$62,426 2% of payroll

On December 10, 2019 the Town Commission approved pension amendments for General Employees (non-sworn) to conform maximum benefit limitations and retirement ages. Effective January 1, 2020 the plan changes are as follows:

- **Increased the benefit cap for general employees (non-sworn) from 68% to 80%**
- **Lowered retirement age** from age 62 and 15 years of service or age 65 and 10 years of service to:
 - ✚ Age 50 and 20 years of service, or
 - ✚ Age 52 and 15 years of service, or
 - ✚ Age 55 and 10 years of service
- **Increased Cost-of-Living Adjustment (COLA) from 1.5% to 2% for future retirees.**

These plan changes were recommended in an effort to align the cap with retirement age.

The below information was collected, prior to recommendation.

Regarding Cap:

Based on the 2018 actuarial study, 63% of the general employees would reach the maximum benefit limitation (cap) before they are eligible to retire. Increasing the benefit cap reduces the percentage of employees who fall on this tier.

The pension actuary, Gabriel Roeder Smith specified that the majority of the plans do not have a cap (other than the statutory 100%). They also said that of the plans that do have a cap, the range is typically 75% - 90%.

The pension attorney stated that of all the plans they represent, Surfside's benefit cap for general employees is the lowest. In addition, data from surrounding municipalities was collected identifying that Bal Harbour's cap is 100%, Bay Harbor's is 100% and Miami Beach's is 90% or 80%.

To put this in perspective, based on the current multiplier (2.8%) for general employees (non-senior management), it will take 28.5 years of service for a general employee to reach the cap ($.80 \div .028 = 28.5$).

Based on the current multiplier, for senior management (3.0%) it will take 26.6 years of service for a senior management employee to reach the cap ($.80 \div .030 = 26.6$).

Regarding COLA:

The pension actuary stated that the average COLA is 2%. The Fraternal Order of Police who represent our police officers, negotiated a 2% COLA for future retirees with their recent collective bargaining agreement. In addition our surrounding municipalities COLA is as follows:

- Bal Harbour's is 2.5%
- Miami Beach 2.5% Tier A and Tier B; 1.5% Tier C

The Town inquired on information on COLA based on the CPI with a floor of 1.5% and a ceiling of 2%. Based on long term inflation assumption, the recommendation by our actuary was 2%.

Regarding Retirement Age:

The Town of Surfside's retirement age requirements were the highest of our surrounding municipalities.

- Bay Harbor: Age 52 and 20 years of service (since 1999), or 55 and 10 years of service, or 65 regardless of years of service;
- Miami Beach: 50 and 5 years of service, or 55 and 5 years of service, 55 and 30 years of service, or 62 and 5 years of service (all based on collective bargaining agreements with their unions); and
- Bal Harbour: 57 regardless of service, or 55 and 25 years of service, or 30 years of service regardless of age.

The retirement age changes grant an opportunity to employees (majority who are public works employees) to retire and enter the Deferred Retirement Option Plan (DROP) program if they choose to, at a younger age.

For example: Solid Waste employee who was hired in 1992 (28 years of service) 58 years old, would have to wait until age 62 to retire and enter the DROP; thus, separating from service at age 67. Our solid waste crew is aging...

This also benefits other employees who are hired at a young age. They don't have to work and then wait for 35+ years to collect their pension. This will encourage employees to remain employed by the Town after vesting, rather than seeking employment elsewhere.

For example: An employee hired in 2018 whose normal retirement date (prior to this age reduction) was 2059. This particular employee would have had to wait 41 years to collect his/her pension.

Upon separation of service of those who opt to retire and not enter the DROP, the Town will more likely hire someone at a lower salary than that of the retiree. In addition, the minimum requirements for the position may have changed to include more experience and higher education.

The disparity between the general employees' benefits, the Town's sworn employees benefits (Police) and the surrounding municipalities is a challenge. The FOP negotiated retirement age reductions and a COLA increase with their 2019 – 2022 collective bargaining agreement. In addition, the Town signed a MOU with the FOP to extend the age reduction benefits to their civilian members who are covered under the general employees' plan. The surrounding municipalities offer higher caps, lower vesting requirements, lower retirement ages etc...

Enclosed please find actuarial impact statements and survey results.

Reviewed by GO

Prepared by YSM

September 6, 2016

Ms. Mayte D. Gamiotea
Pension Administrator
Retirement Plan for Employees of the
Town of Surfside
9293 Harding Avenue
Surfside, Florida 33154

**Re: Retirement Plan for Employees of the Town of Surfside
Actuarial Impact Statement**

Dear Mayte:

As requested, we are pleased to enclose three (3) copies of an Actuarial Impact Statement as of October 1, 2015 for the Proposed Ordinance under the Retirement Plan for Employees of the Town of Surfside (Plan) with the State of Florida (copy enclosed).

Background – General Employees are currently eligible for normal retirement at the earlier of (1) age 62 with 15 years of Creditable Service or (2) age 65 with 10 years of Creditable Service. A participating Town Manager is currently eligible for normal retirement at age 64 with 7 years of Creditable Service.

General Employees are currently 50% vested upon completion of 5 years of Creditable Service, increasing 10% per year until 100% vested upon completion of 10 years of Creditable Service. A participating Town Manager is currently 100% vested upon completion of 7 years of Creditable Service.

General Employees currently contribute either 5% or 6% of pensionable pay. The benefit accrual rate (multiplier) for service earned after January 31, 2003 is currently 2.0% for each year of Creditable Service for the General Employee who contributes 5% of pensionable pay and 2.5% for each year of Creditable Service for General Employees who contribute 6% of pensionable pay. The maximum benefit is currently 60% of average final compensation.

Proposed Ordinance – The proposed Ordinance:

For General Employees – Contribution rate is increased to 8% of pensionable pay for General Employees currently contributing 6% and 7% of pensionable pay for the General Employee currently contributing 5%. Benefit accrual rate (multiplier) for service earned after September 30, 2016 is 2.80% for each year of Creditable Service for General Employees who will contribute 8% of pensionable

pay. Benefit accrual rate (multiplier) for service earned after September 30, 2016 is 2.65% for each year of Creditable Service for the General Employee who will contribute 7% of pensionable pay. Maximum benefit is increased to 68% of average final compensation.

- **For Senior Management Employees** – Contribution rate is increased to 8% of pensionable pay. Benefit accrual rate (multiplier) for service earned after September 30, 2016 is 3% for each year of Creditable Service. Maximum benefit is increased to 80% of average final compensation.
- **For Town Attorney** – Retirement and vesting provisions as currently provided to a participating Town Manager.

Results – The following sets out the projected changes in the minimum annual required contributions for the Town and Employees as a dollar amount and as a percentage of covered General Employee annual payroll (\$3,121,306).

Item	Incremental Cost in Net Town Annual Required Contribution	Incremental Cost in Employee Annual Contribution
Proposed Amendment – reflect changes to General Employees only	\$ (4,828) (0.2%)	\$ 43,050 1.4%
Proposed Amendment – reflect changes to Senior Management Employees only	\$ 4,483 0.1%	\$ 19,376 0.6%
Proposed Amendment – reflect changes to Town Attorney retirement and vesting provisions	\$ 1,250 0.0%	\$ 0 0.0%
Combined Effect	\$ 905 0.0%	\$ 62,426 2.0%

Filing Requirements – We have prepared the Actuarial Impact Statement for filing with the State of Florida. Please note that this Statement must be signed and dated on behalf of the Board of Trustees. Copies of the Ordinance upon passage at first reading along with the signed and dated Actuarial Impact Statement are generally required to be filed with the State at the following address:

Mr. Douglas E. Beckendorf, A.S.A.
 Bureau of Local Retirement Services
 Division of Retirement
 Building 8
 Post Office Box 9000
 Tallahassee, Florida 32315-9000

We understand the State requires funding no later than the fiscal year next following the effective date of the increases in costs resulting from the Ordinance.

Please forward a copy of the Ordinance upon passage at second reading to update our files.

Actuarial Assumptions and Methods, Plan Provisions, Financial Data, Member Census Data – The actuarial assumptions and methods, financial data and member census data employed for purposes of our Actuarial Impact Statement are the same actuarial assumptions and methods, financial data and member census data utilized for the October 1, 2015 Actuarial Valuation.

The Plan provisions employed for purposes of our Actuarial Impact Statement are the same Plan provisions utilized for the October 1, 2015 Actuarial Valuation as modified above.

Senior Management Employees are: participating Town Manager, Town Attorney, Town Clerk, Building and Zoning Director, Code Compliance Director, Finance Director, Human Resources Director, Parks and Recreation Director, Public Works Director and Tourism, Economic Development and Community Services Director.

This Actuarial Impact Statement is intended to describe the estimated future financial effects of the proposed Plan provision changes on the Plan, and is not intended as a recommendation in favor of the benefit changes or in opposition of the Plan provision changes.

If all actuarial assumptions are met and if all future minimum required contributions are paid, Plan assets will be sufficient to pay all Plan benefits. Plan minimum required contributions are determined in compliance with the requirements of the Florida Protection of Public Employee Retirement Benefits Act with normal cost determined as a level percent of covered payroll and a level dollar amortization payment using a maximum amortization period of 30 years.

The Unfunded Actuarial Accrued Liability (UAAL) may not be appropriate for assessing the sufficiency of Plan assets to meet the estimated cost of settling benefit obligations but may be appropriate for assessing the need for or the amount of future contributions. The UAAL would be different if it reflected the market value of assets rather than the smoothed actuarial value of assets.

These calculations are based upon assumptions regarding future events. However, the Plan's long term costs will be determined by actual future events, which may differ materially from the assumptions made. These calculations are also based upon present Plan provisions that are referenced in this Actuarial Impact Statement.

If you have reason to believe the assumptions used are unreasonable, the Plan provisions are incorrectly described as referenced, important Plan provisions relevant to this

proposed Actuarial Impact Statement are not described or that conditions have changed since the calculations were made, you should contact the undersigned prior to relying on information in this Actuarial Impact Statement.

Future actuarial measurements may differ significantly from the current measurements presented in this report due to such factors as the following: Plan experience differing from that anticipated by the economic or demographic assumptions; changes in economic or demographic assumptions; increases or decreases expected as part of the natural operation of the methodology used for these measurements (such as the end of an amortization period); and changes in Plan provisions or applicable law. Due to the limited scope of the actuary's assignment, the actuary did not perform an analysis of the potential range of such future measurements.

This Actuarial Impact Statement should not be relied on for any purpose other than the purpose described in the primary communication. Determinations of the financial results associated with the benefits described in this report in a manner other than the intended purpose may produce significantly different results.

This Actuarial Impact Statement has been prepared by actuaries who have substantial experience valuing public employee retirement plans. To the best of our knowledge the information contained in this report is accurate and fairly presents the actuarial position of the Plan as of the Actuarial Impact Statement date. All calculations have been made in conformity with generally accepted actuarial principles and practices, with the Actuarial Standards of Practice issued by the Actuarial Standards Board and with applicable statutes.

This Actuarial Impact Statement may be provided to parties other than the Board only in its entirety and only with the permission of an approved representative of the Board.

The signing actuaries are independent of the Plan sponsor.

If you have reason to believe that the information provided in this Actuarial Impact Statement is inaccurate, or is in any way incomplete, or if you need further information in order to make an informed decision on the subject matter of this report, please contact the undersigned prior to making such decision.

The undersigned are Members of the American Academy of Actuaries and meet the Qualification Standards of the American Academy of Actuaries to render the actuarial opinion contained herein.

Ms. Mayte D. Gamiotea
September 6, 2016
Page Five

If you should have any question concerning the above or if we may be of further assistance with this matter, please do not hesitate to contact us.

Sincerest regards,



Lawrence F. Wilson, E.A., A.S.A.
Senior Consultant and Actuary



Jennifer M. Borregard, E.A.
Consultant and Actuary

Enclosures

cc: Ms. Yamileth Slate-McCloud

ORDINANCE NO. _____

AN ORDINANCE AMENDING CHAPTER 2, ARTICLE V, DIVISION 2 OF THE CODE OF THE TOWN OF SURFSIDE REGARDING THE RETIREMENT PLAN FOR EMPLOYEES OF THE TOWN OF SURFSIDE; AMENDING SECTION 2-171 OF THE TOWN CODE TO CREATE A DEFINITION OF THE TERM SENIOR MANAGEMENT EMPLOYEE; AMENDING SECTION 2-176(a)(4) OF THE TOWN CODE TO PROVIDE FOR SEVEN YEAR VESTING FOR THE TOWN ATTORNEY; AMENDING SECTION 2-176(c)(1) OF THE TOWN CODE TO INCREASE THE BENEFIT ACCRUAL RATE FOR GENERAL EMPLOYEES AND INCREASING THE BENEFIT CAP FROM 60% TO 68% OF FINAL AVERAGE COMPENSATION; AMENDING SECTION 2-176(c)(1) OF THE TOWN CODE TO INCREASE THE BENEFIT ACCRUAL RATE FOR SENIOR MANAGEMENT EMPLOYEES AND INCREASING THE BENEFIT CAP FROM 60% TO 80% OF FINAL AVERAGE COMPENSATION; AMENDING SECTION 2-180(a) OF THE TOWN CODE TO INCREASE IN THE GENERAL EMPLOYEE AND SENIOR MANAGEMENT EMPLOYEE PICK-UP PENSION CONTRIBUTION BY 2%; PROVIDING FOR SEVERABILITY; PROVIDING FOR INCLUSION IN THE CODE; PROVIDING FOR CONFLICTS AND PROVIDING FOR AN EFFECTIVE DATE.

WHEREAS, the Town of Surfside sponsors a defined benefit retirement plan for employees of the Town of Surfside (“Retirement Plan”); and

WHEREAS, the Board of Trustees of the Retirement Plan has recommended increasing the employee contribution to purchase a higher pension benefit; and

WHEREAS, general employees currently contribute either 5% or 6% of pensionable earnings; and

WHEREAS the actuary for the Board of Trustees has determined that increasing the general employee member contribution from 6% to 8% would provide a 2.8% multiplier. For the employee contributing at the 5% rate, increasing the employee member contribution to 7% would provide a 2.65% multiplier; and

WHEREAS, the Retirement Plan does not currently contain a higher tier benefit for Senior Management Employees; and

WHEREAS, the Board of Trustees has recommended increasing the multiplier and benefit cap for Senior Management Employee; and

WHEREAS, the actuary for the Board of Trustees has determined the financial effect of increasing the Senior Management Employee contribution from 6% to 8% and the multiplier from 2.5% to 3%; and

WHEREAS, the current Town Code provides for the Town Manager to be deemed fully vested at the attainment of age 64 and the completion of 7 years of creditable service; and

WHEREAS, the Retirement Plan does not currently contain a similar benefit for the Town Attorney; and

WHEREAS, the Board of Trustees has recommended providing the Town Attorney to be deemed fully vested at the attainment of age 64 and the completion of 7 years of creditable service; and

WHEREAS, the Town Commission held its first public hearing on September 13, 2016 having complied with the notice requirements required by Florida Statutes; and

WHEREAS, the Town Commission conducted a second duly noticed public hearing on these regulations as required by law on October 13, 2016; and

WHEREAS, the Town Commission finds the proposed amendments to the Code in the best interest of the Town.

NOW THEREFORE, IT IS HEREBY ORDAINED BY THE TOWN COMMISSION OF SURFSIDE TOWN, FLORIDA; AS FOLLOWS:

Section 1. Recitals. That the above stated recitals are hereby adopted and confirmed.

Section 2. Town Code Amended. SECTION 2-171, Definitions, is hereby amended and to be read as follows:

Sec. 2-171. Definitions.

The following words, terms and phrases, when used in this division, shall have the meanings ascribed to them in this section, except where the context clearly indicates a different meaning:

Senior Management Employee: For purposes of the new Senior Management Tier benefit, **Senior Management Employee means the Town Manager, Town Attorney, Town Clerk, Building and Zoning Director, Code Compliance Director, Finance Director, Human Resources Director,**

Parks and Recreation Director, Public Works Director, Tourism, Economic Development and Community Services Director.

Section 3. SECTION 2-176, Service Retirement Allowance, is hereby amended and to be read as follows:

Sec. 2-176. Service Retirement Allowance.

(a) *Normal Retirement date.* Each member who retires or otherwise terminates employment with the town on or after his normal retirement date, as determined below, shall be entitled to receive a service retirement annuity in the amount provided in subsection (c) of this section. Effective October 1, 1984, the normal retirement date for each member shall be the first day of the month coincident with or next following the earlier of:

(4) For the Town Attorney:

a. The attainment of age 62 and the completion of 15 years of creditable service; or

b. The attainment of age 64 and the completion of seven years of creditable service who shall be deemed fully vested upon the completion of seven years of creditable service.

(c) *Computation of annuity.*

(1) For members who are not police officers, the amount of monthly retirement annuity with respect to all creditable service rendered by each member prior to October 1, 1979, shall be equal to 12/3 percent of the monthly average final compensation multiplied by the number of years of creditable service rendered prior to October 1, 1979. For each employee who contributes at the rate of five percent of earnable compensation on and after January 1, 1980, the amount of monthly retirement annuity with respect to creditable service rendered after September 30, 1979, shall be equal to 12/3 percent of the monthly average final compensation multiplied by the number of years of creditable service rendered after September 30, 1979. For each employee who contributes at the rate of seven percent of earnable compensation on and after January 1, 1980, the amount of monthly retirement annuity with respect to creditable service rendered after September 30, 1979, shall be equal to two percent of the monthly average final compensation multiplied by the number of years of creditable service rendered after September 30, 1979. For each member who contributes at the rate of eight percent of earnable compensation after June 30, 1996, the amount of monthly retirement annuity with respect to creditable service rendered after June 30, 1996, shall be equal to two and one-half percent of monthly average final compensation multiplied by the number of years of creditable service rendered after June 30, 1996. For each

member who elects as of July 1, 1996 to increase his contribution from five percent to seven percent of earnable compensation, the amount of retirement annuity with respect to creditable service rendered after June 30, 1996, shall be equal to two percent of monthly average final compensation multiplied by the number of years of creditable service rendered after June 30, 1996. For each member who elects as of July 1, 1996 to increase his contribution rate to seven percent or eight percent of earnable compensation, the amount of retirement annuity with respect to creditable service rendered after September 30, 1979 but before July 1, 1996 shall be equal to one and two-thirds percent, if prior to July 1, 1996 he had been contributing at the rate of five percent, or two percent, if prior to July 1, 1996 he had been contributing at the rate of seven percent, of monthly average final compensation multiplied by the number of years of creditable service rendered after September 30, 1979 but prior to July 1, 1996. The foregoing election periods shall expire on July 31, 1996 and may not be extended for any reason. For each member who contributes at the rate of five percent of earnable compensation on and after February 1, 2003, the amount of monthly retirement annuity with respect to creditable service rendered on and after February 1, 2003 shall be equal to two percent of the monthly average final compensation multiplied by the number of years of creditable service rendered on and after February 1, 2003. For each member who contributes at the rate of six percent of earnable compensation on and after February 1, 2003, the amount of monthly retirement annuity with respect to creditable service rendered on and after February 1, 2003 shall be equal to two and one-half percent of the monthly average final compensation multiplied by the number of years of creditable service rendered on and after February 1, 2003. In no event shall the total annuity as computed above for any member exceed 60 percent of the monthly average final compensation.

For members who are not police officers or Senior Management employees, effective October 1, 2016:

(i) for each member who contributes at the rate of eight percent (8%) of earnable compensation, the amount of monthly retirement annuity with respect to creditable service rendered on and after October 1, 2016 shall be equal to two and eight-tenths percent (2.8%) of monthly average final compensation multiplied by the number of years of creditable service rendered on and after October 1, 2016;

(ii) for the member who contributes at the rate of seven percent (7%) of earnable compensation, the amount of monthly retirement annuity with respect to creditable service rendered on and after October 1, 2016 shall be equal to two and sixty-five one hundredths percent (2.65%) of monthly average final compensation multiplied by the number of years of creditable service rendered on and after October 1, 2016; and

(iii) in no event shall the total annuity as computed above for any member exceed sixty-eight percent (68%) of monthly average final compensation.

For members who are Senior Management employees, effective October 1, 2016:

(i) the amount of monthly retirement annuity with respect to creditable service rendered on and after October 1, 2016 shall be equal to three percent (3%) of monthly average final compensation multiplied by the number of years of creditable service rendered on and after October 1, 2016; and

(ii) in no event shall the total annuity as computed above for any Senior Management employee exceed eighty percent (80%) of monthly average final compensation.

Section 4. SECTION 2-180, Contributions by Members, is hereby amended and to be

read as follows:

~~(a) For members who are not police officers, beginning on the date of establishment of the plan, each town employee who is a member of the plan shall contribute five percent of earnable compensation, based on his regular salary, accruing on and after such date and up to September 30, 1979. Each member of the plan on October 1, 1979, and each employee who becomes a member after October 1, 1979, shall have the irrevocable option of contributing either five percent or seven percent of his earnable compensation from January 1, 1980. Each member of the plan as of July 1, 1996, shall have the one time irrevocable option of raising his contribution rate from five percent to either seven percent or eight percent of earnable compensation, or from seven percent to eight percent of earnable compensation. For each member who elects as of July 1, 1996 to increase his contribution from five percent to seven percent of earnable compensation, the amount of retirement annuity with respect to creditable service rendered after June 30, 1996, shall be equal to two percent of monthly average final compensation multiplied by the number of years of creditable service rendered after June 30, 1996. For each member who elects as of July 1, 1996 to increase his contribution rate to seven percent or eight percent of earnable compensation, the amount of retirement annuity with respect to creditable service rendered after September 30, 1979 but before July 1, 1996 shall be equal to one and two thirds percent, if prior to July 1, 1996 he had been contributing at the rate of five percent, or two percent, if prior to July 1, 1996 he had been contributing at the rate of seven percent, of monthly average final compensation multiplied by the number of years of creditable service rendered after September 30, 1979 but prior to July 1, 1996. The foregoing election periods shall expire on July 31, 1996 and may not be extended for any reason. Each employee who becomes a member of the plan after July 1, 1996 shall thereupon have the one time irrevocable option of contributing either five percent or eight percent of earnable compensation. Each member of the plan as of February 1, 2003 who is contributing at the rate of five percent of earnable compensation shall have the one time irrevocable option of raising his contribution rate from five percent to six percent. For each member who contributes at the rate of seven or eight percent of earnable compensation on January 31, 2003, the contribution~~

~~rate shall be six percent of earnable compensation on and after February 1, 2003. Each employee who becomes a member on or after February 1, 2003 shall contribute six percent of earnable compensation. Such contribution by any member shall cease upon the completion of the number of years of creditable service, sufficient to produce an annuity of 60 percent of average final compensation.~~ For members who are not police officers or Senior Management Employees, effective October 1, 2016:

- (i) The employee contribution for employees contributing six percent (6%) of earnable compensation shall be increased to eight percent (8%) of earnable compensation;
- (ii) The employee contribution for the employee contributing five percent (5%) of earnable compensation shall be increased to seven percent (7%) of earnable compensation;
- (iii) Employee contributions by any member shall cease upon the completion of the number of years of creditable service, sufficient to produce an annuity of sixty-eight percent (68%) of average final compensation.

For members who are Senior Management Employees, effective October 1, 2016:

- (i) The employee contribution shall be increased to eight percent (8%) of earnable compensation;
- (ii) Employee contributions by any Senior Management member shall cease upon the completion of the number of years of creditable service, sufficient to produce an annuity of eighty percent (80%) of average final compensation.

Section 5. All sections or parts of sections of the Town Code, all ordinances or parts of ordinances, and all resolutions or parts of resolutions in conflict herewith, be and the same, are hereby repealed to the extent of such conflict.

Section 6. Should this ordinance or any part thereof be declared invalid by a Court of competent jurisdiction, the invalidity of any part of this ordinance shall not otherwise affect the validity of the remaining provisions of this ordinance, which shall be deemed to have been enacted without the invalid provision.

Section 7. It is the intention of the Commission of the Town of Surfside that the provisions of this ordinance shall become and be made a part of the Code of the Town of Surfside, and that the word "ordinance" may be changed to "section," "article," or such other appropriate word or phrase in order to accomplish such intentions.

Section 8. This ordinance shall become effective upon final passage.

PASSED and ADOPTED on second reading this ____ day of _____, 2016.

On Final Reading Moved by: _____

On Final Reading Second by: _____

FINAL VOTE ON ADOPTION:

Commissioner Daniel Gielchinsky _____
Commissioner Michael Karukin _____
Commissioner Tina Paul _____
Vice Mayor Barry Cohen _____
Mayor Daniel Dietch _____

Daniel Dietch, Mayor

ATTEST:

Sandra Novoa, MMC, Town Clerk

**APPROVED AS TO FORM AND LEGALITY FOR THE USE
AND BENEFIT OF THE TOWN OF SURFSIDE ONLY:**

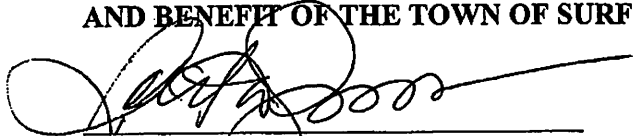

Robert D. Klausner, Esq.
General Counsel
The Retirement Plan for Employees of the Town of Surfside

**Retirement Plan for Employees of the
Town of Surfside, Florida**

Actuarial Impact Statement as of October 1, 2015

A. Description of Proposed Amendment

General Employees:

Employee contribution rate is eight percent (8%) of pensionable pay for General Employees currently contributing six percent (6%) of pensionable pay. Employee contribution rate is seven percent (7%) of pensionable pay for the General Employee currently contributing five percent (5%) of pensionable pay.

Benefit accrual rate is 2.80% per year of Creditable Service earned after September 30, 2016 for General Employees who contribute eight percent (8%) of pensionable pay. Benefit accrual rate is 2.65% per year of Creditable Service earned after September 30, 2016 for the General Employee who contributes seven percent (7%) of pensionable pay.

Maximum benefit cap is 68% of monthly average final compensation.

Senior Management Employees:

Employee contribution rate is eight percent (8%) of pensionable pay.

Benefit accrual rate is 3% per year of Creditable Service earned after September 30, 2016.

Maximum benefit cap is 80% of monthly average final compensation.

Town Attorney:

Normal retirement date shall be the earlier of (1) attainment of age 62 and completion of 15 years of Creditable Service or (2) attainment of age 64 and completion of 7 years of Creditable Service - 100% vested upon completion of seven (7) years of Creditable Service.

B. An estimate of the cost of implementing this amendment (see attachment)

C. In my opinion, the proposed changes are in compliance with Part VII, Chapter 112, Florida Statutes and Section 14, Article X of the State Constitution.

Chairman, Retirement Committee

Date

**Retirement Plan for Employees of the
Town of Surfside, Florida**

Actuarial Impact Statement as of October 1, 2015

General Employees / Senior Management Employees / Town Attorney

<u>A. Participant Data</u>	<u>Actuarial Valuation</u>	<u>Proposed Ordinance</u>
1. Active participants	59	59
2. Terminated vested participants	2	2
3. Participants receiving benefits (including DROPs)	24	24
4. Annual payroll of active employees	\$ 3,121,306	\$ 3,121,306
5. Expected payroll of active employees for the following year	\$ 3,121,306	\$ 3,121,306
 <u>B. Assets</u>		
1. Smoothed actuarial value	\$ 6,659,124	\$ 6,659,124
2. Market value	\$ 6,372,256	\$ 6,372,256
 <u>C. Liabilities</u>		
1. Actuarial present value of future expected benefit payments for active members		
a. Retirement benefits	\$ 4,143,140	\$ 4,572,192
b. Vesting benefits	949,742	988,988
c. Disability benefits	524,603	557,939
d. Return of member contributions	126,783	142,716
e. Total	<u>\$ 5,744,268</u>	<u>\$ 6,261,835</u>
2. Actuarial present value of future expected benefit payments for terminated vested members and miscellaneous	\$ 197,871	\$ 197,871
3. Actuarial present value of future expected benefit payments for those currently receiving benefits (including DROPs)	<u>\$ 3,899,103</u>	<u>\$ 3,899,103</u>
4. Total actuarial present value of future expected benefit payments	\$ 9,841,242	\$ 10,358,809
5. Actuarial accrued liabilities	\$ 7,489,177	\$ 7,778,952
6. Unfunded actuarial accrued liabilities	\$ 830,053	\$ 1,119,828

**Retirement Plan for Employees of the
Town of Surfside, Florida**

Actuarial Impact Statement as of October 1, 2015

General Employees / Senior Management Employees / Town Attorney

	<u>Actuarial Valuation</u>	<u>Proposed Ordinance</u>
D. Statement of Accumulated Plan Benefits		
1. Actuarial present value of accumulated vested benefits		
a. Participants currently receiving benefits	\$ 3,899,103	\$ 3,899,103
b. Other participants	<u>2,098,210</u>	<u>2,166,405</u>
c. Total	\$ 5,997,313	\$ 6,065,508
2. Actuarial present value of accumulated non-vested plan benefits	<u>526,026</u>	<u>660,714</u>
3. Total actuarial present value of accumulated plan benefits	\$ 6,523,339	\$ 6,726,222
E. <u>Pension Cost</u>		
1. Total normal cost	\$ 367,414	\$ 406,313
2. Payment required to amortize unfunded liability	65,535	87,858
3. Interest	<u>6,317</u>	<u>8,426</u>
4. Total required contributions	\$ 439,266	\$ 502,597
5. Item 4 as a percentage of payroll	14.1%	16.1%
6. Estimated employee contributions	\$ 186,891	\$ 249,317
7. Item 6 as a percentage of payroll	6.0%	8.0%
8. Net amount payable by Town	\$ 252,375	\$ 253,280
9. Item 8 as a percentage of payroll	8.1%	8.1%
F. <u>Disclosure of Following Items:</u>		
1. Actuarial present value of future salaries - attained age	\$ 22,876,305	\$ 22,572,170
2. Actuarial present value of future employee contributions - attained age	\$ 1,370,030	\$ 1,803,225
3. Actuarial present value of future contributions from other sources	N/A	N/A
4. Amount of active members' accumulated contributions	\$ 1,161,694	\$ 1,161,694
5. Actuarial present value of future salaries and future benefits at entry age	N/A	N/A
6. Actuarial present value of future employee contributions at entry age	N/A	N/A

**Retirement Plan for Employees of the
Town of Surfside, Florida**

Actuarial Impact Statement as of October 1, 2015

General Employees / Senior Management Employees / Town Attorney

G. Amortization of Unfunded Actuarial Accrued Liability

<u>Date Established</u>		<u>Unfunded Liability</u>	<u>Amortization Payment</u>	<u>Funding Period</u>
10/01/2009	Combined Bases *	\$ 1,984	\$ 187	18 years
10/01/2010	Actuarial (Gain) / Loss	220,977	18,080	25 years
10/01/2010	Assumption Changes	(118,720)	(9,714)	25 years
10/01/2011	Actuarial (Gain) / Loss	80,380	6,484	26 years
10/01/2012	Actuarial (Gain) / Loss	155,693	12,398	27 years
10/01/2012	Assumption Changes	117,634	9,367	27 years
10/01/2013	Actuarial (Gain) / Loss	83	7	28 years
10/01/2014	Actuarial (Gain) / Loss	84,829	6,602	29 years
10/01/2015	Actuarial (Gain) / Loss	148,934	11,473	30 years
10/01/2015	Assumption Changes	138,259	10,651	30 years
10/01/2015	Proposed Amendment	<u>289,775</u>	<u>22,323</u>	30 years
	TOTAL	\$ 1,119,828	\$ 87,858	

* Combined per Internal Revenue Code Regulation 1.412(b)-1

This actuarial valuation and/or cost determination was prepared and completed by me or under my direct supervision, and I acknowledge responsibility for the results. To the best of my knowledge, the results are complete and accurate, and in my opinion, the techniques and assumptions used are reasonable and meet the requirements and intent of Part VII, Chapter 112, Florida Statutes. There is no benefit or expense to be provided by the Plan and/or paid from the Plan's assets for which liabilities or current costs have not been established or otherwise taken into account for in the valuation. All known events or trends which may require a material increase in plan costs or required contribution rates have been taken into account in the valuation.



Lawrence F. Wilson, A.S.A.

Enrollment Number: 14-02802

Dated: September 6, 2016

**Retirement Plan for Employees of the
Town of Surfside, Florida**

Outline of Principal Provisions of the Retirement Plan

A. Effective Date:

January 1, 1962. Most recent amendatory Ordinance considered: 13-1603.

B. Eligibility Requirements:

All regular, full-time employees are eligible upon employment. The Town Manager and Town Attorney have the right to opt out of the Plan at any time.

C. Creditable Service:

All service of a member measured in years and completed calendar months since latest date of hire with the Town.

D. Average Final Compensation (AFC):

The average of basic compensation during the highest three years (five years for General Employees) of the ten years preceding termination of employment; does not include bonuses, overtime, lump sum payments of unused leave or other nonregular payments.

E. Normal Retirement:

1. Eligibility:

For sworn Police Officers, the earliest of (1) age 52 with 20 years of Creditable Service, (2) age 62 with 5 years of Creditable Service, (3) completion of 25 years of Creditable Service or (4) the completion of 15 years and 4 months of service if hired on a full time basis in March 2003. For a participating Town Manager and the Town Attorney, the earlier of (1) age 62 with 15 years of Creditable Service or (2) age 64 with 7 years of Creditable Service. For all other employees, the earlier of (1) age 62 with 15 years of Creditable Service or (2) age 65 with 10 years of Creditable Service.

2. Benefit:

Period of Service	Benefit Accrual Rate per Year of Service Based on Employee Contribution Rate of			
	5%	6%	7%	8%
Before 10/1/1979	1 2/3%	N/A	N/A	N/A
10/1/1979 - 6/30/1996	1 2/3%	N/A	2.0%	N/A
7/1/1996 - 1/31/2003	1 2/3%	N/A	2.0%	2.5%
2/1/2003 - 9/30/2005	2.0%	2.5%	N/A	N/A
10/1/2005 - 9/30/2006	2.0%	2.5%	N/A	3.0% ¹
10/1/2006 - 9/30/2016	2.0%	2.5%	N/A	3.5% ¹
10/1/2016 forward	N/A	N/A	2.65% ²	2.8% ² / 3.0% ³ / 3.5% ¹

Maximum benefit is 90% (75% prior to October 1, 2006) of AFC for Police Officers, 68% (60% prior to October 1, 2016) of AFC for General Employees and 80% (60% prior to October 1, 2016) of AFC for Senior Management Employees.

¹ For Police Officers only.

² For General Employees only.

³ For Senior Management Employees only.

**Retirement Plan for Employees of the
Town of Surfside, Florida**

Outline of Principal Provisions of the Retirement Plan

3. **Form of Payment:**

Straight life annuity with guaranteed refund of Accumulated Contributions (with options available).

F. **Early Retirement:**

1. **Eligibility:**

The earlier of (a) age 55 with 15 years of Creditable Service, or (b) 20 years of Creditable Service regardless of age.

2. **Benefit:**

Same as Normal Retirement Benefit using AFC and Creditable Service as of Early Retirement Date but payable at Normal Retirement Date assuming continued employment. Alternatively, benefits may commence immediately after reduction of 0.5% for each month early.

G. **Delayed Retirement:**

1. **Eligibility:**

Retirement after Normal Retirement Date.

2. **Benefit:**

Calculated in the same manner as Normal Retirement Benefit using AFC and Creditable Service as of delayed retirement date.

H. **Disability Retirement:**

1. **Service Connected:**

a) **Eligibility:**

Total and permanent disability incurred prior to normal retirement date as a direct result of performance of service to the Town and eligible for Social Security disability benefits.

b) **Benefit:**

75% (if injury) or 45% (if disease) of the rate of pay in effect on date of disability payable for life or until recovery. For General Employees, less Social Security disability benefits; there is an offset for Workers' Compensation to the extent that the disability benefit plus the Workers' Compensation benefit exceed 100% of preretirement salary.

2. **Non-Service Connected:**

a) **Eligibility:**

Total and permanent disability not incurred as a direct result of performance of service to the Town.

**Retirement Plan for Employees of the
Town of Surfside, Florida**

Outline of Principal Provisions of the Retirement Plan

b) Benefit:

Accrued pension benefit.

I. Death Benefit:

1. Pre-Retirement:

Refund of Accumulated Contributions

2. After Normal Retirement Date but before Actual Retirement:

Survivor benefit payable in accordance with optional form of benefit chosen by member.

3. After Retirement:

Refund of any remaining Accumulated Contributions or optional survivor's benefits if elected.

J. Accumulated Contributions:

The sum of all amounts contributed by members including 4% interest on contributions made after January 1, 1979. Effective January 1, 2009, member contributions are *picked-up* by the Town.

K. Termination Benefit:

Upon termination prior to normal or early retirement date a member shall be entitled to choose (1) or (2) below, where:

1. A refund of Accumulated Contributions.

2. The benefit as for normal retirement using AFC and Creditable Service as of date of termination multiplied by the applicable percentage on the table below, commencing upon the earliest date a member would have attained normal retirement had he remained in service (age 65 for General Employees).

<u>Years of Creditable Service</u>	<u>Percentage</u>	
	<u>General Employees</u>	<u>Police Officers</u>
Less than 5	0%	0%
5	50%	100%
6	60%	100%
7	70%	100%
8	80%	100%
9	90%	100%
10 or more	100%	100%

3. A participating Town Manager and the Town Attorney 100% vested upon completion of 7 years of Creditable Service.

**Retirement Plan for Employees of the
Town of Surfside, Florida**

Outline of Principal Provisions of the Retirement Plan

L. Cost of Living Increase

A 1.5% automatic annual cost of living increase is provided for all current and future retirees, disableds, beneficiaries and vested terminated members.

M. Deferred Retirement Option Program (DROP)

1. Eligibility: Attainment of normal retirement date.
2. The maximum period of participation in the DROP is five (5) years.
3. An employee's account in the DROP program shall be credited with interest based upon actual Fund investment return.
4. No payment may be made from DROP until the employee actually separates from service with the Town.

N. Changes From Previous Valuation

1. Normal Retirement was:

1. Eligibility:

For sworn Police Officers, the earliest of (1) age 52 with 20 years of Creditable Service, (2) age 62 with 5 years of Creditable Service, (3) completion of 25 years of Creditable Service or (4) the completion of 15 years and 4 months of service if hired on a full time basis in March 2003. For a participating Town Manager, age 64 with 7 years of Creditable Service. For all other employees, the earlier of (1) age 62 with 15 years of Creditable Service or (2) age 65 with 10 years of Creditable Service.

2. Benefit:

Period of Service	Benefit Accrual Rate per Year of Service Based on Employee Contribution Rate of			
	5%	6%	7%	8%
Before 10/1/1979	1 2/3%	N/A	N/A	N/A
10/1/1979 - 6/30/1996	1 2/3%	N/A	2%	N/A
7/1/1996 - 1/31/2003	1 2/3%	N/A	2%	2.5%
2/1/2003 - 9/30/2005	2%	2.5%	N/A	N/A
10/1/2005 - 9/30/2006	2%	2.5%	N/A	3% *
After 10/1/2006	2%	2.5%	N/A	3.5% *

Maximum benefit is 90% (75% prior to October 1, 2006) of AFC (60% of AFC for General Employees).

* For Police Officers only.

**Retirement Plan for Employees of the
Town of Surfside, Florida**

Outline of Principal Provisions of the Retirement Plan

N. Changes From Previous Valuation (cont'd)

2. Termination Benefit was:

Upon termination prior to normal or early retirement date a member shall be entitled to choose (1) or (2) below, where:

1. A refund of Accumulated Contributions.
2. The benefit as for normal retirement using AFC and Creditable Service as of date of termination multiplied by the applicable percentage on the table below, commencing upon the earliest date a member would have attained normal retirement had he remained in service (age 65 for General Employees).

<u>Years of Creditable Service</u>	<u>Percentage</u>	
	<u>General Employees</u>	<u>Police Officers</u>
Less than 5	0%	0%
5	50%	100%
6	60%	100%
7	70%	100%
8	80%	100%
9	90%	100%
10 or more	100%	100%

3. Participating Town Manager 100% vested upon completion of 7 years of Creditable Service.

**Retirement Plan for Employees of the
Town of Surfside, Florida**

**Actuarial Assumptions and Actuarial Cost Methods
Used in the Valuation**

A. Mortality

For healthy male participants, RP 2000 Annuitant Male Mortality Table, with 10% White Collar / 90% Blue Collar Adjustment for Police Officers - 50% White Collar / 50% Blue Collar Adjustment for General Employees and fully generational mortality improvements projected to each future decrement date with Scale BB. For healthy female participants, RP 2000 Annuitant Female Mortality Table, with White Collar Adjustment and fully generational mortality improvements projected to each future decrement date with Scale BB.

For disabled male Police Officers, 60% RP 2000 Disabled Male Mortality Table setback four years / 40% RP 2000 Annuitant Male Mortality Table, with White Collar Adjustment and no setback, without projected mortality improvements. For disabled female Police Officers, 60% RP 2000 Disabled Female Mortality Table set forward two years / 40% RP 2000 Annuitant Female Mortality Table, with White Collar Adjustment, without projected mortality improvements.

For disabled male General Employees, RP 2000 Disabled Male Mortality Table, setback four years, without projected mortality improvements. For disabled female General Employees, RP 2000 Disabled Female Mortality Table, set forward two years, without projected mortality improvements.

B. Investment Return

7.25%, compounded annually; net rate after investment related expenses.

C. Allowances for Expenses or Contingencies

Estimated expenses for upcoming year, not including investment related expenses.

D. Employee Withdrawal Rates

Withdrawal rates for males and females were used in accordance with the following illustrative examples:

<u>General Employees</u>	
<u>Age</u>	<u>Withdrawal Rate</u>
Under 25	30.0%
25 - 29	20.0%
30 - 34	15.0%
35 - 39	10.0%
40 - 44	9.0%
45 - 49	8.0%
50 - 54	7.0%
55 - 60	6.0%
60 & over	5.0%

**Retirement Plan for Employees of the
Town of Surfside, Florida**

**Actuarial Assumptions and Actuarial Cost Methods
Used in the Valuation**

D. Employee Withdrawal Rates (cont'd)

<u>Police Officers</u>	
<u>Service</u>	<u>Withdrawal Rate</u>
0 - 4	12.0%
5 - 6	10.0%
7	5.0%
8	2.0%
9 & over	1.0%

E. Salary Increase Factors

Current salary is assumed to increase at a rate based on the tables below.

<u>General Employees</u>	
<u>Service</u>	<u>Salary Increase</u>
0 - 4	6.5%
4 - 5	6.0%
6	5.0%
7 - 9	4.5%
10 & over	4.0%

<u>Police Officers</u>	
<u>Service</u>	<u>Salary Increase</u>
0 - 3	8.0%
3	7.0%
4 - 5	6.0%
6	5.0%
7 & over	4.0%

**Retirement Plan for Employees of the
Town of Surfside, Florida**

**Actuarial Assumptions and Actuarial Cost Methods
Used in the Valuation**

F. Disability Benefits

1. Rates: See Table Below
2. Percent Service Connected: 25% for General, 80% for Police.
3. Assume 50% of Service Connected Disabilities are due to injury and 50% are due to disease.

Age	Annual Rate of Disability	
	General Employees	Police Department
20	0.07%	0.14%
30	0.11%	0.18%
40	0.19%	0.30%
50	0.51%	1.00%
60	1.66%	0.00%

G. Smoothed Actuarial Value of Assets

The method used for determining the smoothed actuarial value of assets phases in the deviation between the expected and actual return on assets at the rate of 20% per year. The smoothed actuarial value of assets will be further adjusted to the extent necessary to fall within the corridor whose lower limit is 80% of the fair market value of plan assets and whose upper limit is 120% of the fair market value of plan assets.

H. Assumed Retirement Age

Age	Annual Rate of Retirement*	
	General Employees	Police Officers
40	N/A	3%
41-45	4%	2%
46-47	3%	1%
48-50	2%	1%
51 & over	1%	1%
NRA	40%	50%
Past NRA	50%	50%

100% of members are assumed to retire upon reaching age 70 for General Employees and age 65 for Police Officers.

* For Employees who meet the age and service eligibility requirements for normal or early retirement

**Retirement Plan for Employees of the
Town of Surfside, Florida**

**Actuarial Assumptions and Actuarial Cost Methods
Used in the Valuation**

I. Marriage Assumption

100% of all members are assumed to be married. Wives are assumed to be three years younger than their husbands.

J. Actuarial Funding Method

Normal Retirement, Termination, Disability, and Death Benefits: Entry-Age-Actuarial Cost Method. Under this method the normal cost for each active employee is the amount which is calculated to be a level percentage of pay that would be required annually from his age at hire to his assumed retirement age to fund his estimated benefits, assuming the Plan has always been in effect. The normal cost for the Plan is the sum of such amounts for all employees. The actuarial accrued liability as of any valuation date for each active employee or inactive employee who is eligible to receive benefits under the Plan is the excess of the actuarial present value of estimated future benefits over the actuarial present value of current and future normal costs. The unfunded actuarial accrued liability as of any valuation date is the excess of the smoothed actuarial accrued liability over the actuarial value of assets of the Plan.

K. Change From Previous Valuation

None.

ORDINANCE NO. 16-1652

AN ORDINANCE AMENDING CHAPTER 2, ARTICLE V, DIVISION 2 OF THE CODE OF THE TOWN OF SURFSIDE REGARDING THE RETIREMENT PLAN FOR EMPLOYEES OF THE TOWN OF SURFSIDE; AMENDING SECTION 2-171 OF THE TOWN CODE TO CREATE A DEFINITION OF THE TERM SENIOR MANAGEMENT EMPLOYEE; AMENDING SECTION 2-176(a)(4) OF THE TOWN CODE TO PROVIDE FOR SEVEN YEAR VESTING FOR THE TOWN ATTORNEY; AMENDING SECTION 2-176(c)(1) OF THE TOWN CODE TO INCREASE THE BENEFIT ACCRUAL RATE FOR GENERAL EMPLOYEES AND INCREASING THE BENEFIT CAP FROM 60% TO 68% OF FINAL AVERAGE COMPENSATION; AMENDING SECTION 2-176(c)(1) OF THE TOWN CODE TO INCREASE THE BENEFIT ACCRUAL RATE FOR SENIOR MANAGEMENT EMPLOYEES AND INCREASING THE BENEFIT CAP FROM 60% TO 80% OF FINAL AVERAGE COMPENSATION; AMENDING SECTION 2-180(a) OF THE TOWN CODE TO INCREASE IN THE GENERAL EMPLOYEE AND SENIOR MANAGEMENT EMPLOYEE PICK-UP PENSION CONTRIBUTION BY 2%; PROVIDING FOR SEVERABILITY; PROVIDING FOR INCLUSION IN THE CODE; PROVIDING FOR CONFLICTS AND PROVIDING FOR AN EFFECTIVE DATE.

WHEREAS, the Town of Surfside sponsors a defined benefit retirement plan for employees of the Town of Surfside ("Retirement Plan"); and

WHEREAS, the Board of Trustees of the Retirement Plan has recommended increasing the employee contribution to purchase a higher pension benefit; and

WHEREAS, general employees currently contribute either 5% or 6% of pensionable earnings; and

WHEREAS the actuary for the Board of Trustees has determined that increasing the general employee member contribution from 6% to 8% would provide a 2.8% multiplier. For the employee contributing at the 5% rate, increasing the employee member contribution to 7% would provide a 2.65% multiplier; and

WHEREAS, the Retirement Plan does not currently contain a higher tier benefit for Senior Management Employees; and

WHEREAS, the Board of Trustees has recommended increasing the multiplier and benefit cap for Senior Management Employee; and

WHEREAS, the actuary for the Board of Trustees has determined the financial effect of increasing the Senior Management Employee contribution from 6% to 8% and the multiplier from 2.5% to 3%; and

WHEREAS, the current Town Code provides for the Town Manager to be deemed fully vested at the attainment of age 64 and the completion of 7 years of creditable service; and

WHEREAS, the Retirement Plan does not currently contain a similar benefit for the Town Attorney; and

WHEREAS, the Board of Trustees has recommended providing the Town Attorney to be deemed fully vested at the attainment of age 64 and the completion of 7 years of credited service; and

WHEREAS, the Town Commission held its first public hearing on September 13, 2016 having complied with the notice requirements required by Florida Statutes; and

WHEREAS, the Town Commission conducted a second duly noticed public hearing on these regulations as required by law on October 13, 2016; and

WHEREAS, the Town Commission finds the proposed amendments to the Code in the best interest of the Town.

NOW THEREFORE, IT IS HEREBY ORDAINED BY THE TOWN COMMISSION OF SURFSIDE TOWN, FLORIDA; AS FOLLOWS:

Section 1. Recitals. That the above stated recitals are hereby adopted and confirmed.

Section 2. Town Code Amended. SECTION 2-171, Definitions, is hereby amended and to be read as follows:

Sec. 2-171. Definitions.

The following words, terms and phrases, when used in this division, shall have the meanings ascribed to them in this section, except where the context clearly indicates a different meaning:

Senior Management Employee: For purposes of the new Senior Management Tier benefit, **Senior Management Employee means the Town Manager, Town Attorney, Town Clerk, Building and Zoning Department Director, Code Compliance Director, Finance Director, Human**

Resources Director, Parks and Recreation Director, Public Works Director, Tourism, Economic Development and Community Services Director.

Section 3. SECTION 2-176, Service Retirement Allowance, is hereby amended and to be read as follows:

Sec. 2-176. Service Retirement Allowance.

(a) *Normal Retirement date.* Each member who retires or otherwise terminates employment with the town on or after his normal retirement date, as determined below, shall be entitled to receive a service retirement annuity in the amount provided in subsection (c) of this section. Effective October 1, 1984, the normal retirement date for each member shall be the first day of the month coincident with or next following the earlier of:

(4) For the Town Attorney:

a. The attainment of age 62 and the completion of 15 years of creditable service; or

b. The attainment of age 64 and the completion of seven years of creditable service who shall be deemed fully vested upon the completion of seven years of creditable service.

(c) *Computation of annuity.*

(1) For members who are not police officers, the amount of monthly retirement annuity with respect to all creditable service rendered by each member prior to October 1, 1979, shall be equal to 12/3 percent of the monthly average final compensation multiplied by the number of years of creditable service rendered prior to October 1, 1979. For each employee who contributes at the rate of five percent of earnable compensation on and after January 1, 1980, the amount of monthly retirement annuity with respect to creditable service rendered after September 30, 1979, shall be equal to 12/3 percent of the monthly average final compensation multiplied by the number of years of creditable service rendered after September 30, 1979. For each employee who contributes at the rate of seven percent of earnable compensation on and after January 1, 1980, the amount of monthly retirement annuity with respect to creditable service rendered after September 30, 1979, shall be equal to two percent of the monthly average final compensation multiplied by the number of years of creditable service rendered after September 30, 1979. For each member who contributes at the rate of eight percent of earnable compensation after June 30, 1996, the amount of monthly retirement annuity with respect to creditable service rendered after June 30, 1996, shall be equal to two and one-half percent of monthly average final compensation multiplied by the number of years of creditable service rendered after June 30, 1996. For each

member who elects as of July 1, 1996 to increase his contribution from five percent to seven percent of earnable compensation, the amount of retirement annuity with respect to creditable service rendered after June 30, 1996, shall be equal to two percent of monthly average final compensation multiplied by the number of years of creditable service rendered after June 30, 1996. For each member who elects as of July 1, 1996 to increase his contribution rate to seven percent or eight percent of earnable compensation, the amount of retirement annuity with respect to creditable service rendered after September 30, 1979 but before July 1, 1996 shall be equal to one and two-thirds percent, if prior to July 1, 1996 he had been contributing at the rate of five percent, or two percent, if prior to July 1, 1996 he had been contributing at the rate of seven percent, of monthly average final compensation multiplied by the number of years of creditable service rendered after September 30, 1979 but prior to July 1, 1996. The foregoing election periods shall expire on July 31, 1996 and may not be extended for any reason. For each member who contributes at the rate of five percent of earnable compensation on and after February 1, 2003, the amount of monthly retirement annuity with respect to creditable service rendered on and after February 1, 2003 shall be equal to two percent of the monthly average final compensation multiplied by the number of years of creditable service rendered on and after February 1, 2003. For each member who contributes at the rate of six percent of earnable compensation on and after February 1, 2003, the amount of monthly retirement annuity with respect to creditable service rendered on and after February 1, 2003 shall be equal to two and one-half percent of the monthly average final compensation multiplied by the number of years of creditable service rendered on and after February 1, 2003. In no event shall the total annuity as computed above for any member exceed 60 percent of the monthly average final compensation.

For members who are not police officers or Senior Management employees, effective October 1, 2016:

(i) for each member who contributes at the rate of eight percent (8%) of earnable compensation, the amount of monthly retirement annuity with respect to creditable service rendered on and after October 1, 2016 shall be equal to two and eight-tenths percent (2.8%) of monthly average final compensation multiplied by the number of years of creditable service rendered on and after October 1, 2016;

(ii) for the member who contributes at the rate of seven percent (7%) of earnable compensation, the amount of monthly retirement annuity with respect to creditable service rendered on and after October 1, 2016 shall be equal to two and sixty-five one hundredths percent (2.65%) of monthly average final compensation multiplied by the number of years of creditable service rendered on and after October 1, 2016; and

(iii) in no event shall the total annuity as computed above for any member exceed sixty-eight percent (68%) of monthly average final compensation.

For members who are Senior Management employees, effective October 1, 2016:

(i) the amount of monthly retirement annuity with respect to creditable service rendered on and after October 1, 2016 shall be equal to three percent (3%) of monthly average final compensation multiplied by the number of years of creditable service rendered on and after October 1, 2016; and

(ii) in no event shall the total annuity as computed above for any Senior Management employee exceed eighty percent (80%) of monthly average final compensation.

Section 4. SECTION 2-180, Contributions by Members, is hereby amended and to be

read as follows:

~~(a) For members who are not police officers, beginning on the date of establishment of the plan, each town employee who is a member of the plan shall contribute five percent of earnable compensation, based on his regular salary, accruing on and after such date and up to September 30, 1979. Each member of the plan on October 1, 1979, and each employee who becomes a member after October 1, 1979, shall have the irrevocable option of contributing either five percent or seven percent of his earnable compensation from January 1, 1980. Each member of the plan as of July 1, 1996, shall have the one-time irrevocable option of raising his contribution rate from five percent to either seven percent or eight percent of earnable compensation, or from seven percent to eight percent of earnable compensation. For each member who elects as of July 1, 1996 to increase his contribution from five percent to seven percent of earnable compensation, the amount of retirement annuity with respect to creditable service rendered after June 30, 1996, shall be equal to two percent of monthly average final compensation multiplied by the number of years of creditable service rendered after June 30, 1996. For each member who elects as of July 1, 1996 to increase his contribution rate to seven percent or eight percent of earnable compensation, the amount of retirement annuity with respect to creditable service rendered after September 30, 1979 but before July 1, 1996 shall be equal to one and two-thirds percent, if prior to July 1, 1996 he had been contributing at the rate of five percent, or two percent, if prior to July 1, 1996 he had been contributing at the rate of seven percent, of monthly average final compensation multiplied by the number of years of creditable service rendered after September 30, 1979 but prior to July 1, 1996. The foregoing election periods shall expire on July 31, 1996 and may not be extended for any reason. Each employee who becomes a member of the plan after July 1, 1996 shall thereupon have the one-time irrevocable option of contributing either five percent or eight percent of earnable compensation. Each member of the plan as of February 1, 2003 who is contributing at the rate of five percent of earnable compensation shall have the one-time irrevocable option of raising his contribution rate from five percent to six percent. For each member who contributes at the rate of seven or eight percent of earnable compensation on January 31, 2003, the contribution~~

~~rate shall be six percent of earnable compensation on and after February 1, 2003. Each employee who becomes a member on or after February 1, 2003 shall contribute six percent of earnable compensation. Such contribution by any member shall cease upon the completion of the number of years of creditable service, sufficient to produce an annuity of 60 percent of average final compensation.~~ For members who are not police officers or Senior Management Employees, effective October 1, 2016:

- (i) The employee contribution for employees contributing six percent (6%) of earnable compensation shall be increased to eight percent (8%) of earnable compensation;
- (ii) The employee contribution for the employee contributing five percent (5%) of earnable compensation shall be increased to seven percent (7%) of earnable compensation;
- (iii) Employee contributions by any member shall cease upon the completion of the number of years of creditable service, sufficient to produce an annuity of sixty-eight percent (68%) of average final compensation.

For members who are Senior Management Employees, effective October 1, 2016:

- (i) The employee contribution shall be increased to eight percent (8%) of earnable compensation;
- (ii) Employee contributions by any Senior Management member shall cease upon the completion of the number of years of creditable service, sufficient to produce an annuity of eighty percent (80%) of average final compensation.

Section 5. All sections or parts of sections of the Town Code, all ordinances or parts of ordinances, and all resolutions or parts of resolutions in conflict herewith, be and the same, are hereby repealed to the extent of such conflict.

Section 6. Should this ordinance or any part thereof be declared invalid by a Court of competent jurisdiction, the invalidity of any part of this ordinance shall not otherwise affect the validity of the remaining provisions of this ordinance, which shall be deemed to have been enacted without the invalid provision.

Section 7. It is the intention of the Commission of the Town of Surfside that the provisions of this ordinance shall become and be made a part of the Code of the Town of Surfside, and that the word "ordinance" may be changed to "section," "article," or such other appropriate word or phrase in order to accomplish such intentions.

Section 8. This ordinance shall become effective upon final passage.

PASSED and ADOPTED on second reading this 13th day of October 2016.

On Final Reading Moved by: Commissioner Paul

On Final Reading Second by: Commissioner Karukin

FINAL VOTE ON ADOPTION:

Commissioner Daniel Gielchinsky	<u>yes</u>
Commissioner Michael Karukin	<u>yes</u>
Commissioner Tina Paul	<u>yes</u>
Vice Mayor Barry Cohen	<u>yes</u>
Mayor Daniel Dietch	<u>yes</u>



Daniel Dietch, Mayor

ATTEST: 

Sandra Novoa, MMC, Town Clerk

APPROVED AS TO FORM AND LEGALITY FOR THE USE AND BENEFIT OF THE TOWN OF SURFSIDE ONLY:

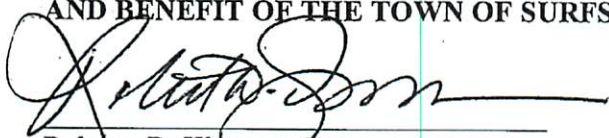

Robert D. Klausner, Esq.
General Counsel
The Retirement Plan for Employees of the Town of Surfside

January 10, 2020

Ms. Mayte D. Gamiotea
Pension Administrator
Retirement Plan for Employees of the
Town of Surfside
9293 Harding Avenue
Surfside, Florida 33154

**Re: Retirement Plan for Employees of the Town of Surfside
Actuarial Impact Statement**

Dear Mayte:

As requested, we are pleased to enclose twelve (12) copies of our Actuarial Impact Statement as of October 1, 2018 for filing the proposed Ordinance under the Retirement Plan for Employees of the Town of Surfside (Plan) with the State of Florida (copy enclosed) prior to second reading.

Background – The Plan currently provides the General Employees, Communication Operators and Senior Management Employees with the following provisions:

- Normal retirement eligibility is the earlier of:
 - (1) attainment of age sixty-two (62) and completion of fifteen (15) years of service or
 - (2) attainment of age sixty-five (65) and completion of ten (10) years of service.
- Automatic annual cost of living increases of 1.5%.
- Maximum benefits are 68% of Average Final Compensation (AFC) for General Employees and Communication Operators and 80% of AFC for Senior Management Employees.

Proposed Ordinance – The proposed Ordinance provides for General Employees, Communication Operators and Senior Management Employees as follows:

- Normal Retirement Eligibility
Allow for normal retirement upon the earliest of:
 - (1) attainment of age fifty (50) and completion of twenty (20) years of service,
 - (2) attainment of age fifty-two (52) and completion of fifteen (15) years of service or
 - (3) attainment of age fifty-five (55) and completion of ten (10) years of service.
- Automatic Annual Cost of Living Increases – excluding Communication Operators
Increasing automatic annual cost of living increase from 1.5% to 2.0% for retirees, disableds, beneficiaries and vested terminated members who retire on or after January 1, 2020.

- Maximum Benefit Cap increased to 80% of AFC for General Employees and Communication Operators.

Cost – The total impact of the proposed Ordinance results in an expected increase in the first year Net Town Minimum Funding Payment of \$173,483.

Filing Requirements – We have prepared the Actuarial Impact Statement for filing with the State of Florida. Please note that this Statement must be signed and dated on behalf of the Board of Trustees. Copies of the Ordinance upon passage at first reading along with the signed and dated Actuarial Impact Statement are generally required to be filed with the State at the following address:

Mr. Douglas E. Beckendorf, A.S.A.
Bureau of Local Retirement Services
Division of Retirement
Building 8
Post Office Box 9000
Tallahassee, Florida 32315-9000

We understand the State requires funding any increases in costs no later than the fiscal year next following the effective date of the Ordinance.

Please forward a copy of the Ordinance upon passage at second reading to update our files.

Actuarial assumptions and methods, financial data, Plan provisions and member census data – The actuarial assumptions and methods, financial data and member census data employed for purposes of our Actuarial Impact Statement are the same actuarial assumptions and methods, financial data and member census data utilized for the October 1, 2018 Actuarial Valuation of the Plan with the following exceptions:

Normal Retirement rates were changed to the following:

- ❖ For General Employees and Communication Operators:
 - Ages before reaching the maximum benefit cap:
 - Ages < 65 = 5%
 - Ages 65 to 69 = 50%
 - Age 70 = 100%
 - Ages at or after reaching the maximum benefit cap:
 - All Ages = 100%

- ❖ For Senior Management:
 - Ages before reaching the maximum benefit cap:
 - Ages < 65 = 5%
 - Ages 65 to 69 = 50%
 - Age 70 = 100%
 - Ages at or after reaching the maximum benefit cap:
 - Ages < 65 = 35%
 - Ages 65 to 69 = 50%
 - Age 70 = 100%

The Plan provisions employed for purposes of our Actuarial Impact Statement are the same Plan provisions utilized in the October 1, 2018 Actuarial Valuation of the Plan with the exception of the proposed changes described above.

Risk Assessment – Risk assessment may include scenario tests, sensitivity, or stress tests, stochastic modeling, and a comparison of the present value of benefits at low-risk discount rates. We are prepared to perform such assessment to aid the Town in the decision making process. Please refer to the October 1, 2018 Actuarial Valuation Report dated July 22, 2019 for additional discussion regarding the risks associated with measuring the accrued liability and the minimum funding payment.

This Actuarial Impact Statement is intended to describe the estimated future financial effects of the proposed benefit changes on the Plan and is not intended as a recommendation in favor of the benefit changes nor in opposition to the benefit changes.

If all actuarial assumptions are met and if all current and future minimum required contributions are paid, Plan assets will be sufficient to pay all Plan benefits, future contributions are expected to remain relatively stable as a percent of payroll and the funded status is expected to improve. Plan minimum required contributions are determined in compliance with the requirements of the Florida Protection of Public Employee Retirement Benefits Act with normal cost determined as a level percent of covered payroll and a level dollar amortization payment using an initial amortization period of 30 years.

The Unfunded Actuarial Accrued Liability (UAAL) may not be appropriate for assessing the sufficiency of Plan assets to meet the estimated cost of settling benefit obligations but may be appropriate for assessing the need for or the amount of future contributions. The UAAL would be different if it reflected the market value of assets rather than the smoothed value of assets.

These calculations are based upon assumptions regarding future events. However, the Plan's long term costs will be determined by actual future events, which may differ materially from the

assumptions made. These calculations are also based upon present and proposed Plan provisions that are outlined or referenced in this Actuarial Impact Statement.

If you have reason to believe the assumptions used are unreasonable, the Plan provisions are incorrectly described or referenced, important Plan provisions relevant to this Actuarial Impact Statement are not described or that conditions have changed since the calculations were made, you should contact the undersigned prior to relying on information in this Actuarial Impact Statement.

If you have reason to believe that the information provided in this Actuarial Impact Statement is inaccurate, or is in any way incomplete, or if you need further information in order to make an informed decision on the subject matter of this report, please contact the undersigned prior to making such decision.

Future actuarial measurements may differ significantly from the current measurements presented in this report due to such factors as the following: Plan experience differing from that anticipated by the economic or demographic assumptions; changes in economic or demographic assumptions; increases or decreases expected as part of the natural operation of the methodology used for these measurements (such as the end of an amortization period) and changes in Plan provisions or applicable law. Due to the limited scope of our assignment, we did not perform an analysis of the potential range of such future measurements.

This Actuarial Impact Statement should not be relied on for any purpose other than the purpose described in the primary communication. Determinations of the financial results associated with the benefits described in this report in a manner other than the intended purpose may produce significantly different results.

This Actuarial Impact Statement has been prepared by actuaries who have substantial experience valuing public employee retirement systems. To the best of our knowledge the information contained in this report is accurate and fairly presents the actuarial position of the Plan as of the valuation date. All calculations have been made in conformity with generally accepted actuarial principles and practices, with the Actuarial Standards of Practice issued by the Actuarial Standards Board and with applicable statutes.

This Actuarial Impact Statement may be provided to parties other than the Board only in its entirety and only with the permission of an approved representative of the Board.

The signing actuaries are independent of the Plan sponsor.

The undersigned are Members of the American Academy of Actuaries and meet the Qualification Standards of the American Academy of Actuaries to render the actuarial opinion contained herein.

Ms. Mayte D. Gamiotea
January 10, 2020
Page Five

If you should have any question concerning the above or if we may be of further assistance with this matter, please do not hesitate to contact us.

Sincerest regards,

Michelle Jones

Shelly L. Jones, A.S.A., E.A., M.A.A.A, F.C.A.
Consultant and Actuary

Nicolas Lahaye

Nicolas Lahaye, F.S.A., E.A., M.A.A.A, F.C.A.
Consultant and Actuary

Enclosures

ORDINANCE NO. _____

AN ORDINANCE AMENDING CHAPTER 2, ARTICLE V, DIVISION 2 OF THE CODE OF THE TOWN OF SURFSIDE REGARDING THE RETIREMENT PLAN FOR EMPLOYEES OF THE TOWN OF SURFSIDE; AMENDING SECTION 2-176(a) OF THE TOWN CODE TO LOWER RETIREMENT AGES FOR NON-PUBLIC SAFETY EMPLOYEES CONSISTENT WITH MAXIMUM BENEFIT LIMITATIONS; AMENDING SECTION 2-176(c) OF THE TOWN CODE TO INCREASE THE MAXIMUM BENEFIT LIMITATION FROM 68% TO 80% FOR GENERAL EMPLOYEES; AMENDING SECTION 2-192 OF THE TOWN CODE TO INCREASE THE COST OF LIVING ADJUSTMENT FROM 1.5% TO 2% PER YEAR FOR NON-PUBLIC SAFETY EMPLOYEES; PROVIDING FOR SEVERABILITY; PROVIDING FOR CODIFICATION; AND PROVIDING AN EFFECTIVE DATE.

WHEREAS, the Town of Surfside sponsors a defined benefit retirement plan for employees of the Town of Surfside (“Retirement Plan”);

WHEREAS, the Board of Trustees of the Retirement Plan, after a review of benefits in surrounding cities, has recommended enhancing pension benefits to align retirement ages with the Retirement Plan’s maximum benefit limitation (hereinafter the “benefit cap”);

WHEREAS, general employees currently contribute 8% of pensionable earnings;

WHEREAS, the maximum benefit cap for general employees is currently 68% for general employees and 80% for management employees;

WHEREAS, approximately 63% of general employees reach the maximum benefit cap of 68% before they are eligible to retire;

WHEREAS, notwithstanding the pension cost, there are anticipated to be savings from a recruitment standpoint, by reducing turnover and making the Retirement Plan more competitive with surrounding cities;

WHEREAS, the Commission of the Town of Surfside believes that the adoption of this amendment is in the best interests of the citizens and taxpayers of the Town;

NOW, THEREFORE, BE IT ORDAINED by the Town Commission of the Town of

Surfside:

Section 1. SECTION 2-176(a), Service Retirement Allowance, is hereby amended and to be read as follows:

Sec. 2-176. Service Retirement Allowance.

- (a) Normal retirement date. Each member who retires or otherwise terminates employment with the town on or after his normal retirement date, as determined below, shall be entitled to receive a service retirement annuity in the amount provided in subsection (c) of this section. Effective ~~October 1, 1984~~ January 1, 2020, the normal retirement date for each member shall be the first day of the month coincident with or next following the earlier of:

- (2) For members who are not sworn law enforcement officers, the earliest of:
- a. ~~The attainment of age 62 and the completion of 15 years of creditable service; or~~
 - b. ~~The attainment of age 65 and the completion of ten years of creditable service.~~
 - a. The attainment of age fifty (50) and completion of twenty (20) years of service;
 - b. The attainment of age fifty-two (52) and completion of fifteen (15) years of service; or
 - c. The attainment of age fifty-five (55) and completion of ten (10) years of service.

Section 2. SECTION 2-176(c), Service Retirement Allowance, is hereby amended and to be read as follows:

Sec. 2-176. Service Retirement Allowance.

- (c) Computation of annuity:
- (1) For members who are not police officers, the amount of monthly retirement annuity with respect to all creditable service rendered by each member prior to October 1, 1979, shall be equal to 1 2/3 percent of the monthly average final compensation multiplied by the number of years of creditable service rendered prior to October 1, 1979. For each employee who contributes at the rate of five percent of earnable compensation on and after January 1, 1980, the amount of monthly retirement annuity with respect to creditable service rendered after September 30, 1979, shall be equal to 1 2/3 percent of the monthly average final compensation multiplied by the number of years of creditable service rendered

after September 30, 1979. For each employee who contributes at the rate of seven percent of earnable compensation on and after January 1, 1980, the amount of monthly retirement annuity with respect to creditable service rendered after September 30, 1979, shall be equal to two percent of the monthly average final compensation multiplied by the number of years of creditable service rendered after September 30, 1979. For each member who contributes at the rate of eight percent of earnable compensation after June 30, 1996, the amount of monthly retirement annuity with respect to creditable service rendered after June 30, 1996, shall be equal to two and one-half percent of monthly average final compensation multiplied by the number of years of creditable service rendered after June 30, 1996. For each member who elects as of July 1, 1996 to increase his contribution from five percent to seven percent of earnable compensation, the amount of retirement annuity with respect to creditable service rendered after June 30, 1996, shall be equal to two percent of monthly average final compensation multiplied by the number of years of creditable service rendered after June 30, 1996. For each member who elects as of July 1, 1996 to increase his contribution rate to seven percent or eight percent of earnable compensation, the amount of retirement annuity with respect to creditable service rendered after September 30, 1979 but before July 1, 1996 shall be equal to one and two-thirds percent, if prior to July 1, 1996 he had been contributing at the rate of five percent, or two percent, if prior to July 1, 1996 he had been contributing at the rate of seven percent, of monthly average final compensation multiplied by the number of years of creditable service rendered after September 30, 1979 but prior to July 1, 1996. The foregoing election periods shall expire on July 31, 1996 and may not be extended for any reason. For each member who contributes at the rate of five percent of earnable compensation on and after February 1, 2003, the amount of monthly retirement annuity with respect to creditable service rendered on and after February 1, 2003 shall be equal to two percent of the monthly average final compensation multiplied by the number of years of creditable service rendered on and after February 1, 2003. For each member who contributes at the rate of six percent of earnable compensation on and after February 1, 2003, the amount of monthly retirement annuity with respect to creditable service rendered on and after February 1, 2003 shall be equal to two and one-half percent of the monthly average final compensation multiplied by the number of years of creditable service rendered on and after February 1, 2003. In no event shall the total annuity as computed above for any member exceed 60 percent of the monthly average final compensation.

For members who are not police officers or senior management employees, effective October 1, 2016:

- (i) For each member who contributes at the rate of eight percent (8%) of earnable compensation, the amount of monthly retirement annuity with respect to creditable service rendered on and after October 1, 2016 shall be equal to two and eight-tenths percent (2.8%) of monthly average final

compensation multiplied by the number of years of creditable service rendered on and after October 1, 2016;

- (ii) For the member who contributes at the rate of seven percent (7%) of earnable compensation, the amount of monthly retirement annuity with respect to creditable service rendered on and after October 1, 2016 shall be equal to two and sixty-five one hundredths percent (2.65%) of monthly average final compensation multiplied by the number of years of creditable service rendered on and after October 1, 2016; and
- (iii) In no event shall the total annuity as computed above for any member exceed ~~sixty-eight~~ eighty percent (~~68%~~ 80%) of monthly average final compensation, effective January 1, 2020.

Section 3. SECTION 2-192, Cost-of-living adjustment for retired members and their beneficiaries, is hereby amended and to be read as follows:

Sec. 2-192. - Cost-of-living adjustment for retired members and their beneficiaries.

- (a) The purpose of this section is to provide a cost-of-living adjustment to the benefits payable to retired members on or after January 1, 2004 and their beneficiaries.
- (b) Commencing on the first day of January, 2004 and on the first day of each January thereafter, the benefit of each retired member or beneficiary shall be adjusted as follows:
 - (1) The amount of the monthly benefit payable for the 12-month period commencing on the first adjustment date shall be the amount of the monthly benefit plus one and one-half percent. The amount of the monthly benefit payable for subsequent twelve-month periods shall be the amount of the monthly benefit being received on January 1 immediately preceding the adjustment date plus an amount equal to one and one-half percent of said benefit. Effective January 1, 2020, the cost of living benefit shall be two percent (2%) for all members who retire on or after January 1, 2020.

Section 4. All sections or parts of sections of the Town Code, all ordinances or parts of ordinances, and all resolutions or parts of resolutions in conflict herewith, be and the same, are hereby repealed to the extent of such conflict.

Section 5. Should this ordinance or any part thereof be declared invalid by a Court of competent jurisdiction, the invalidity of any part of this ordinance shall not otherwise affect the validity of the remaining provisions of this ordinance, which shall be deemed to have been enacted without the invalid provision.

Commissioner Barry Cohen	yes___	no___
Commissioner Michael Karukin	yes___	no___
Commissioner Tina Paul	yes___	no___

Actuarial Impact Statement as of October 1, 2018

A. Description of Proposed Amendment

Normal Retirement Eligibility

For General Employees, Communication Operators and Senior Management Employees, the earliest of

- (1) Age 50 with 20 years of Creditable Service;
- (2) Age 52 with 15 years of Creditable Service; or
- (3) Age 55 with 10 years of Creditable Service.

Normal Retirement Benefit

Maximum benefit is 80% of AFC for General Employees and Communication Operators.

Cost of Living Increase

For General and Senior Management retirees, disableds, beneficiaries and vested terminated members who retire on or after January 1, 2020, a 2.0% automatic annual cost of living increase is provided.

- B. An estimate of the cost implementing this amendment is attached.
- C. In my opinion, the proposed changes are in compliance with Part VII, Chapter 112, Florida Statutes and Section 14, Article X of the State Constitution.

Chairman, Pension Board

Date

Actuarial Impact Statement as of October 1, 2018

General Employees / Senior Management Employees

	Valuation <u>10/01/2018</u>	Actuarial Impact Statement <u>10/01/2018</u>
A. <u>Participant Data</u>		
1. Active participants	64	64
2. Retired, disabled and beneficiaries receiving benefits (including DROPs)	24	24
3. Terminated vested participants	4	4
4. Annual payroll of active participants	\$ 3,422,731	\$ 3,422,731
5. Expected payroll of active employees for the following year	\$ 3,422,731	\$ 3,422,731
6. Annual benefits payable to those currently receiving benefits	\$ 379,868	\$ 379,868
B. <u>Assets</u>		
1. Smoothed actuarial value	\$ 8,784,384	\$ 8,784,384
2. Market value	\$ 8,890,663	\$ 8,890,663
C. <u>Liabilities</u>		
1. Actuarial present value of future expected benefit payments for active members		
a. Retirement benefits	\$ 6,216,110	\$ 8,573,271
b. Vesting benefits	1,156,020	802,101
c. Disability benefits	725,504	662,859
d. Return of member contributions	134,010	131,584
e. Total	\$ 8,231,644	\$ 10,169,815
2. Actuarial present value of future expected benefit payments for terminated vested members and miscellaneous	\$ 285,863	\$ 285,863
3. Actuarial present value of future expected benefit payments for members currently receiving benefits (including DROPs)	\$ 4,291,037	\$ 4,291,037
4. Total actuarial present value of future expected benefit payments	\$ 12,808,544	\$ 14,746,715
5. Actuarial accrued liabilities	\$ 10,055,380	\$ 11,487,613
6. Unfunded actuarial accrued liabilities	\$ 1,270,996	\$ 2,703,229

Actuarial Impact Statement as of October 1, 2018

General Employees / Senior Management Employees

	<u>Valuation</u> <u>10/01/2018</u>	<u>Actuarial Impact</u> <u>Statement</u> <u>10/01/2018</u>
D. <u>Statement of Accumulated Plan Benefits</u>		
1. Actuarial present value of accumulated vested benefits		
a. Participants currently receiving benefits	\$ 4,291,037	\$ 4,291,037
b. Terminated vested members and miscellaneous	285,863	285,863
c. Other participants	3,450,249	3,982,061
d. Total	<u>\$ 8,027,149</u>	<u>\$ 8,558,961</u>
2. Actuarial present value of accumulated non-vested plan benefits	<u>575,577</u>	<u>598,161</u>
3. Total actuarial present value of accumulated plan benefits	\$ 8,602,726	\$ 9,157,122
E. <u>Pension Cost</u>		
1. Total normal cost	\$ 435,758	\$ 498,908
2. Payment required to amortize unfunded liability	102,938	213,270
3. Interest	9,240	9,241
4. Total required contributions	<u>\$ 547,936</u>	<u>\$ 721,419</u>
5. Item 4 as a percentage of payroll	16.0%	21.1%
6. Estimated employee contributions	\$ 273,396	\$ 273,396
7. Item 6 as a percentage of payroll	8.0%	8.0%
8. Net amount payable by Town	\$ 274,540	\$ 448,023
9. Item 8 as a percentage of payroll	8.0%	13.1%
F. <u>Disclosure of Following Items:</u>		
1. Actuarial present value of future salaries - attained age	\$ 25,248,413	\$ 24,725,182
2. Actuarial present value of future employee contributions - attained age	\$ 2,017,976	\$ 1,975,632
3. Actuarial present value of future contributions from other sources	N/A	N/A
4. Amount of active members' accumulated contributions	\$ 1,771,075	\$ 1,771,075
5. Actuarial present value of future salaries and future benefits at entry age	N/A	N/A
6. Actuarial present value of future employee contributions at entry age	N/A	N/A

Actuarial Impact Statement as of October 1, 2018

General Employees / Senior Management Employees

<u>Date</u>	<u>Unfunded Actuarial Accrued Liabilities</u>	<u>Current Unfunded Liabilities</u>	<u>Amortization Payment</u>	<u>Remaining Funding Period</u>
10/01/2009	Combined Bases *	\$ 1,727	\$ 180	15 years
10/01/2010	Actuarial (Gain) / Loss	202,973	17,466	22 years
10/01/2010	Assumption Changes	(109,046)	(9,383)	22 years
10/01/2011	Actuarial (Gain) / Loss	74,190	6,268	23 years
10/01/2012	Actuarial (Gain) / Loss	144,335	11,992	24 years
10/01/2012	Assumption Changes	109,052	9,061	24 years
10/01/2013	Actuarial (Gain) / Loss	77	6	25 years
10/01/2014	Actuarial (Gain) / Loss	79,239	6,392	26 years
10/01/2015	Actuarial (Gain) / Loss	139,573	11,114	27 years
10/01/2015	Assumption Changes	129,570	10,318	27 years
10/01/2015	Plan Amendment	271,565	21,625	27 years
10/01/2016	Actuarial (Gain) / Loss	282,350	22,217	28 years
10/01/2016	Assumption Changes	34,263	2,696	28 years
10/01/2017	Actuarial (Gain) / Loss	(212,997)	(16,576)	29 years
10/01/2018	Actuarial (Gain) / Loss	124,125	9,562	30 years
10/01/2018	Plan Amendment	1,432,233	110,332	30 years
	Total	\$ 2,703,229	\$ 213,270	

* Combined per Internal Revenue Code Regulation 1.412(b)-1

This Actuarial Valuation and/or cost determination was prepared and completed by us or under our direct supervision, and we acknowledge responsibility for the results. To the best of our knowledge, the results are complete and accurate, and in our opinion, the techniques and assumptions used are reasonable and meet the requirements and intent of Part VII, Chapter 112, Florida Statutes. There is no benefit or expense to be provided by the Plan and/or paid from the Plan's assets for which liabilities or current costs have not been established or otherwise provided for in the valuation. All known events or trends which may require material increase in Plan costs or required contribution rates have been taken into account in the valuation.

Jennifer Borregard

Jennifer M. Borregard, E.A.
Enrollment Number: 17-07624
Date: January 10, 2020

Michelle Jones

Shelly L. Jones, A.S.A.
Enrollment Number: 17-08684

Outline of Principal Provisions of the Retirement Plan

A. Effective Date:

January 1, 1962. Most recent amendatory Ordinance considered: 16-2392.

B. Eligibility Requirements:

All regular, full-time employees are eligible upon employment. The Town Manager and Town Attorney have the right to opt out of the Plan.

C. Creditable Service:

All service of a member measured in years and completed calendar months since latest date of hire with the Town.

D. Average Final Compensation (AFC):

The average of basic compensation during the highest three years (five years for General Employees) of the ten years preceding termination of employment; does not include bonuses, overtime, lump sum payments of unused leave or other nonregular payments.

E. Normal Retirement:

1. Eligibility:

For sworn Police Officers, the earliest of (1) age 52 with 20 years of Creditable Service, (2) age 62 with 5 years of Creditable Service, (3) completion of 25 years of Creditable Service or (4) the completion of 15 years and 4 months of service if hired on a full time basis in March 2003. For a participating Town Manager and the Town Attorney, the earlier of (1) age 62 with 15 years of Creditable Service or (2) age 64 with 7 years of Creditable Service. For all other employees, the earliest of (1) age 50 with 20 years of Creditable Service, (2) age 52 with 15 years of Creditable Service or (3) age 55 with 10 years of Creditable Service.

2. Benefit:

Period of Service	Benefit Accrual Rate per Year of Service Based on Employee Contribution Rate of			
	5%	6%	7%	8%
Before 10/1/1979	1 2/3%	N/A	N/A	N/A
10/1/1979 - 6/30/1996	1 2/3%	N/A	2.0%	N/A
7/1/1996 - 1/31/2003	1 2/3%	N/A	2.0%	2.5%
2/1/2003 - 9/30/2005	2.0%	2.5%	N/A	N/A
10/1/2005 - 9/30/2006	2.0%	2.5%	N/A	3.0% ¹
10/1/2006 - 9/30/2016	2.0%	2.5%	N/A	3.5% ¹
10/1/2016 forward	N/A	N/A	2.65% ²	2.8% ² / 3.0% ³ / 3.5% ¹

Maximum benefit is 90% (75% prior to October 1, 2006) of AFC for Police Officers, 80% (68% prior to January 1, 2020, 60% prior to October 1, 2016) of AFC for General Employees and 80% (60% prior to October 1, 2016) of AFC for Senior Management Employees.

¹ For Police Officers only.

² For General Employees only.

³ For Senior Management Employees only.

Outline of Principal Provisions of the Retirement Plan

3. Form of Payment:

Straight life annuity with guaranteed refund of Accumulated Contributions (with options available).

F. Early Retirement:

1. Eligibility:

20 years of Creditable Service regardless of age.

2. Benefit:

Same as Normal Retirement Benefit using AFC and Creditable Service as of Early Retirement Date but payable at Normal Retirement Date assuming continued employment. Alternatively, benefits may commence immediately after reduction of 0.5% for each month early.

G. Delayed Retirement:

1. Eligibility:

Retirement after Normal Retirement Date.

2. Benefit:

Calculated in the same manner as Normal Retirement Benefit using AFC and Creditable Service as of delayed retirement date.

H. Disability Retirement:

1. Service Connected:

a) Eligibility:

Total and permanent disability incurred prior to normal retirement date as a direct result of performance of service to the Town and eligible for Social Security disability benefits.

b) Benefit:

75% (if injury) or 45% (if disease) of the rate of pay in effect on date of disability payable for life or until recovery. For General Employees, less Social Security disability benefits; there is an offset for Workers' Compensation to the extent that the disability benefit plus the Workers' Compensation benefit exceed 100% of preretirement salary.

2. Non-Service Connected:

a) Eligibility:

Total and permanent disability not incurred as a direct result of performance of service to the Town.

Outline of Principal Provisions of the Retirement Plan

b) Benefit:

Accrued pension benefit.

I. Death Benefit:

1. Pre-Retirement:

Refund of Accumulated Contributions

2. After Normal Retirement Date but before Actual Retirement:

Survivor benefit payable in accordance with optional form of benefit chosen by member.

3. After Retirement:

Refund of any remaining Accumulated Contributions or optional survivor's benefits if elected.

J. Accumulated Contributions:

The sum of all amounts contributed by members including 4% interest on contributions made after January 1, 1979. Effective January 1, 2009, member contributions are *picked-up* by the Town.

K. Termination Benefit:

Upon termination prior to normal or early retirement date a member shall be entitled to choose (1) or (2) below, where:

1. A refund of Accumulated Contributions.
2. The benefit as for normal retirement using AFC and Creditable Service as of date of termination multiplied by the applicable percentage on the table below, commencing upon the earliest date a member would have attained normal retirement had he remained in service (age 65 for General Employees).

<u>Years of Creditable Service</u>	<u>Percentage</u>	
	<u>General Employees</u>	<u>Police Officers</u>
Less than 5	0%	0%
5	50%	100%
6	60%	100%
7	70%	100%
8	80%	100%
9	90%	100%
10 or more	100%	100%

3. A participating Town Manager and the Town Attorney 100% vested upon completion of 7 years of Creditable Service.

Outline of Principal Provisions of the Retirement Plan

L. Cost of Living Increase

For Police Officers and Communication Employees, a 1.5% automatic annual cost of living increase is provided for all current and future retirees, disableds, beneficiaries and vested terminated members.

For General and Senior Management retirees, disableds, beneficiaries and vested terminated members who retire before January 1, 2020, a 1.5% automatic annual cost of living increase is provided. For General and Senior Management retirees, disableds, beneficiaries and vested terminated members who retire on or after January 1, 2020, a 2.0% automatic annual cost of living increase is provided.

M. Deferred Retirement Option Program (DROP)

1. Eligibility: Attainment of normal retirement date.
2. The maximum period of participation in the DROP is five (5) years.
3. An employee's account in the DROP program shall be credited with interest based upon actual Fund investment return.
4. No payment may be made from DROP until the employee actually separates from service with the Town.

N. Changes Since Previous Actuarial Valuation

Normal Retirement was:

Eligibility:

For all other employees, the earlier of (1) age 62 with 15 years of Creditable Service or (2) age 65 with 10 years of Creditable Service.

Benefit:

Maximum benefit was 68% of AFC for General Employees (60% prior to October 1, 2016).

Early Retirement was:

Eligibility:

The earlier of (a) age 55 with 15 years of Creditable Service, or (b) 20 years of Creditable Service

Cost of Living Increases were:

A 1.5% automatic annual cost of living increase is provided for all current and future retirees, disableds, beneficiaries and vested terminated members.

Actuarial Assumptions and Actuarial Cost Methods
Used in the Valuation

A. Mortality

General Mortality Assumptions:

For healthy male participants during employment, RP 2000 Combined Male Healthy Participant Mortality Table, with 50% White Collar / 50% Blue Collar Adjustment and fully generational mortality improvements projected to each future decrement date with Scale BB. For healthy female participants during employment, RP 2000 Combined Female Healthy Participant Mortality Table, with White Collar Adjustment and fully generational mortality improvements projected to each future decrement date with Scale BB.

For healthy male participants post employment, RP 2000 Annuitant Male Mortality Table, with 50% White Collar / 50% Blue Collar Adjustment and fully generational mortality improvements projected to each future decrement date with Scale BB. For healthy female participants post employment, RP 2000 Annuitant Female Mortality Table, with White Collar Adjustment and fully generational mortality improvements projected to each future decrement date with Scale BB.

For disabled male participants, RP 2000 Disabled Male Mortality Table, setback four years, without projected mortality improvements. For disabled female participants, RP 2000 Disabled Female Mortality Table, set forward two years, without projected mortality improvements.

Sample Ages (2018)	Pre-retirement Future Life Expectancy (Years)		Post-retirement Future Life Expectancy (Years)	
	Male	Female	Male	Female
	55	30.53	33.57	30.10
60	25.60	28.54	25.44	28.44
62	23.70	26.58	23.60	26.52

Sample Ages (2038)	Pre-retirement Future Life Expectancy (Years)		Post-retirement Future Life Expectancy (Years)	
	Male	Female	Male	Female
	55	32.67	35.41	32.26
60	27.78	30.38	27.63	30.30
62	25.87	28.40	25.78	28.35

Actuarial Assumptions and Actuarial Cost Methods
Used in the Valuation

A. Mortality (cont'd)

Police Mortality Assumptions:

For healthy participants during employment, RP 2000 Combined Healthy Participant Mortality Tables, separate rates for males and females, with 90% Blue Collar Adjustment / 10% White Collar Adjustment and fully generational mortality improvements projected to each future decrement date with Scale BB.

For healthy participants post employment, RP 2000 Annuitant Mortality Tables, separate rates for males and females, with 90% Blue Collar Adjustment / 10% White Collar Adjustment and fully generational mortality improvements projected to each future decrement date with Scale BB.

For disabled male participants, 60% RP 2000 Disabled Male Mortality Table setback four years / 40% RP 2000 Annuitant Male Mortality Table, with White Collar Adjustment and no setback, without projected mortality improvements. For disabled female participants, 60% RP 2000 Disabled Female Mortality Table set forward two years / 40% RP 2000 Annuitant Female Mortality Table, with White Collar Adjustment, without projected mortality improvements.

Sample Ages (2018)	Pre-retirement Future Life Expectancy (Years)		Post-retirement Future Life Expectancy (Years)	
	Male	Female	Male	Female
	55	29.84	32.60	29.33
60	24.96	27.56	24.76	27.41
62	23.09	25.59	22.97	25.49

Sample Ages (2038)	Pre-retirement Future Life Expectancy (Years)		Post-retirement Future Life Expectancy (Years)	
	Male	Female	Male	Female
	55	32.06	34.54	31.57
60	27.21	29.49	27.03	29.36
62	25.34	27.51	25.23	27.42

Actuarial Assumptions and Actuarial Cost Methods
Used in the Valuation

B. Investment Return

7.25%, compounded annually - net of investment expenses includes inflation at 2.50%.

C. Allowances for Expenses or Contingencies

Estimated expenses for upcoming year, not including investment related expenses.

D. Employee Withdrawal Rates

Withdrawal rates for males and females were used in accordance with the following illustrative examples:

<u>General Employees</u>	
<u>Age</u>	<u>Withdrawal Rate</u>
Under 25	30.0%
25 - 29	20.0%
30 - 34	15.0%
35 - 39	10.0%
40 - 44	9.0%
45 - 49	8.0%
50 - 54	7.0%
55 - 60	6.0%
60 & over	5.0%

<u>Police Officers</u>	
<u>Service</u>	<u>Withdrawal Rate</u>
0 - 4	12.0%
5 - 6	10.0%
7	5.0%
8	2.0%
9 & over	1.0%

Actuarial Assumptions and Actuarial Cost Methods
Used in the Valuation

E. Salary Increase Factors

Current salary is assumed to increase at a rate based on the tables below - includes assumed wage inflation of 3.0%.

General Employees	
<u>Service</u>	<u>Salary Increase</u>
0 - 3	6.5%
4 - 5	6.0%
6	5.0%
7 - 9	4.5%
10 & over	4.0%

Police Officers	
<u>Service</u>	<u>Salary Increase</u>
0 - 2	8.0%
3	7.0%
4 - 5	6.0%
6	5.0%
7 & over	4.0%

F. Disability Benefits

1. Rates: See Table Below
2. Percent Service Connected: 25% for General, 80% for Police.
3. Assume 50% of Service Connected Disabilities are due to injury and 50% are due to disease.

Age	Annual Rate of Disability	
	General Employees	Police Department
20	0.07%	0.14%
30	0.11%	0.18%
40	0.19%	0.30%
50	0.51%	1.00%
60	1.66%	0.00%

Actuarial Assumptions and Actuarial Cost Methods
Used in the Valuation

G. Smoothed Actuarial Value of Assets

The method used for determining the smoothed actuarial value of assets phases in the deviation between the expected and actual return on assets at the rate of 20% per year. The smoothed actuarial value of assets will be further adjusted to the extent necessary to fall within the corridor whose lower limit is 80% of the fair market value of Plan assets and whose upper limit is 120% of the fair market value of Plan assets.

H. Assumed Retirement Age

		Annual Rate of Retirement*		
Age	General Employees	Senior Management	Age	Police Officers
Rates when the maximum benefit cap is not applicable				
40	N/A	N/A	40	3%
41-45	4%	4%	41-45	2%
46-47	3%	3%	46-47	1%
48-49	2%	2%	48-50	1%
50-64	5%	5%	51 & over	1%
65-69	50%	50%	NRA	50%
70	100%	100%	Past NRA	50%
Rates when the maximum benefit cap is applicable				
50-64	100%	35%		
65-69	100%	50%		
70	100%	100%		

100% of members are assumed to retire upon reaching age 65 for Police Officers.

* For Employees who meet the age and service eligibility requirements for normal or early retirement

I. Marriage Assumption

100% of all members are assumed to be married. Wives are assumed to be three years younger than their husbands.

J. Actuarial Funding Method

Normal Retirement, Termination, Disability, and Death Benefits: Entry-Age-Actuarial Cost Method.

Under this method the normal cost for each active employee is the amount which is calculated to be a level percentage of pay that would be required annually from his age at hire to his assumed retirement age to fund his estimated benefits, assuming the Plan has always been in effect. The normal cost for the Plan is the sum of such amounts for all employees. The actuarial accrued liability as of any valuation date for each active employee or inactive employee who is eligible to receive benefits under the Plan is the excess of the actuarial present value of estimated future benefits over the actuarial present value of current and future normal costs. The unfunded actuarial accrued liability as of any valuation date is the excess of the actuarial accrued liability over the smoothed actuarial value of assets of the Plan.

Actuarial Assumptions and Actuarial Cost Methods
Used in the Valuation

K. Change Since Previous Actuarial Valuation

Assumed Retirement Age was:

Age	Annual Rate of Retirement*	
	General Employees	Police Officers
40	N/A	3%
41-45	4%	2%
46-47	3%	1%
48-50	2%	1%
51 & over	1%	1%
NRA	40%	50%
Past NRA	50%	50%

100% of members are assumed to retire upon reaching age 70 for General Employees and age 65 for Police Officers.

* For Employees who meet the age and service eligibility requirements for normal or early retirement

Retirement Benefit Comparison for General Employees
October 2019

RETIREMENT BENEFIT	SURFSIDE	BAL HARBOUR	BAY HARBOR	MIAMI BEACH	Pension Board Proposal
<p>Normal Retirement Date (general employees)</p>	<p>* 62 birthday and 15 years of credited service; or * 65 birthday and 10 years of credited service</p>	<p>* Age 57 regardless of service; * 55 birthday and 25 years of credited service; or * 30 years of continuous service, regardless of age</p>	<p>* 52 birthday and 20 years of credited service; or * 55 birthday and 10 years of credited service; or * 65 birthday without regard to length of credited service</p>	<p>* Age 50 and 5 years of credited service (Tier A- All other members); or * Age 55 and 5 years of credited service (Tier B - AFSCME hired on or after April 30, 1993; members classified as GSA or other hired on or after August 1, 1993, members of CWA hired on or after February 21, 1994; and unclassified members hired on or after October 18, 1992) * Age 55 and 30 years of service or age 62 with 5 years of service (Tier C - All members hired on or after September 30, 2010 (October 27, 2010 for members of CWA). Benefits for employees hired on or after July 14, 2010 and prior to September 31, 2013-The normal retirement date shall be as provided in sec. 66, except that a member must complete at least five years of creditable service, and must attain age 48 to be eligible for "Rule of 70" retirement.</p>	<p>Attainment of age 50 and completion of 20 years of service; the attainment of age 52 and completion of 15 years of service; or the attainment of age 55 and the completion of 10 years of service</p>

Retirement Benefit Comparison for General Employees
October 2019

Benefit CAP	% general; 80 % Senior Management	100%	100%	90 % cap for Tier A members; 80% cap for Tier B and C members	Increase maximum benefit cap to 80%
RETIREMENT BENEFIT	SURFSIDE	BAL HARBOUR	BAY HARBOR	MIAMI BEACH	Pension Board Proposal
Current Multiplier	2.8 % general employees, and 3% senior management	3%	2.75%	3%	
Vesting Schedule	5 years of service = 50%; 6 years of service = 60%; 7 years of service = 70%; 8 years of service = 80%; 9 years of service = 90% and 10 years of service = 100 %	Less than 1 year of service = 0 %; 1 year of service = 10%; 2 years of service = 20%; 3 years of service = 30%; 4 years of service = 40%; 5 years of service = 50%; 6 years of service = 60%; 7 years of service = 70%; 8 years of service = 80%; 9 years of service = 90% and 10 years of service = 100 %	For members who terminate service on or after February 12, 2018 : * Less than 5 completed years of service = none * 5 completed years of service = 100%		
COLA	1.50%	2.50%		2.5 % Tier A and Tier B; 1.5% Tier C	2%

**Retirement Benefit Comparison for General Employees
October 2019**

Member Contribution	8%	8%	<p>At a minimum 2% ; General employee members desiring to increase their benefit accrual rate for membership may at their individual discretion, elect to make additional, voluntary contributions to the fund such that the total amount will be any full percentage rate from three percent to ten percent.</p>	12 % Tier A; 10% Tier B and C
----------------------------	----	----	---	-------------------------------

—

ORDINANCE NO. 2020-1707

AN ORDINANCE AMENDING CHAPTER 2, ARTICLE V, DIVISION 2 OF THE CODE OF THE TOWN OF SURFSIDE REGARDING THE RETIREMENT PLAN FOR EMPLOYEES OF THE TOWN OF SURFSIDE; AMENDING SECTION 2-176(a) OF THE TOWN CODE TO LOWER RETIREMENT AGES FOR NON-PUBLIC SAFETY EMPLOYEES CONSISTENT WITH MAXIMUM BENEFIT LIMITATIONS; AMENDING SECTION 2-176(c) OF THE TOWN CODE TO INCREASE THE MAXIMUM BENEFIT LIMITATION FROM 68% TO 80% FOR GENERAL EMPLOYEES; AMENDING SECTION 2-192 OF THE TOWN CODE TO INCREASE THE COST OF LIVING ADJUSTMENT FROM 1.5% TO 2% PER YEAR FOR NON-PUBLIC SAFETY EMPLOYEES; PROVIDING FOR SEVERABILITY; PROVIDING FOR CODIFICATION; AND PROVIDING AN EFFECTIVE DATE.

WHEREAS, the Town of Surfside sponsors a defined benefit retirement plan for employees of the Town of Surfside (“Retirement Plan”);

WHEREAS, the Board of Trustees of the Retirement Plan, after a review of benefits in surrounding cities, has recommended enhancing pension benefits to align retirement ages with the Retirement Plan’s maximum benefit limitation (hereinafter the “benefit cap”);

WHEREAS, general employees currently contribute 8% of pensionable earnings;

WHEREAS, the maximum benefit cap for general employees is currently 68% for general employees and 80% for management employees;

WHEREAS, approximately 63% of general employees reach the maximum benefit cap of 68% before they are eligible to retire;

WHEREAS, notwithstanding the pension cost, there are anticipated to be savings from a recruitment standpoint, by reducing turnover and making the Retirement Plan more competitive with surrounding cities;

WHEREAS, the Commission of the Town of Surfside believes that the adoption of this amendment is in the best interests of the citizens and taxpayers of the Town;

NOW, THEREFORE, BE IT ORDAINED by the Town Commission of the Town of Surfside:

Section 1. SECTION 2-176(a), Service Retirement Allowance, is hereby amended and to be read as follows:

Sec. 2-176. Service Retirement Allowance.

- (a) Normal retirement date. Each member who retires or otherwise terminates employment with the town on or after his normal retirement date, as determined below, shall be entitled to receive a service retirement annuity in the amount provided in subsection (c) of this section. Effective ~~October 1, 1984~~ January 1, 2020, the normal retirement date for each member shall be the first day of the month coincident with or next following the earlier of:

- (2) For members who are not sworn law enforcement officers, the earliest of:
- a. ~~The attainment of age 62 and the completion of 15 years of creditable service; or~~
 - b. ~~The attainment of age 65 and the completion of ten years of creditable service.~~
 - a. The attainment of age fifty (50) and completion of twenty (20) years of service;
 - b. The attainment of age fifty-two (52) and completion of fifteen (15) years of service; or
 - c. The attainment of age fifty-five (55) and completion of ten (10) years of service.

Section 2. SECTION 2-176(c), Service Retirement Allowance, is hereby amended and to be read as follows:

Sec. 2-176. Service Retirement Allowance.

- (c) Computation of annuity:
- (1) For members who are not police officers, the amount of monthly retirement annuity with respect to all creditable service rendered by each member prior to October 1, 1979, shall be equal to 1 2/3 percent of the monthly average final compensation multiplied by the number of years of creditable service rendered

prior to October 1, 1979. For each employee who contributes at the rate of five percent of earnable compensation on and after January 1, 1980, the amount of monthly retirement annuity with respect to creditable service rendered after September 30, 1979, shall be equal to $1\frac{2}{3}$ percent of the monthly average final compensation multiplied by the number of years of creditable service rendered after September 30, 1979. For each employee who contributes at the rate of seven percent of earnable compensation on and after January 1, 1980, the amount of monthly retirement annuity with respect to creditable service rendered after September 30, 1979, shall be equal to two percent of the monthly average final compensation multiplied by the number of years of creditable service rendered after September 30, 1979. For each member who contributes at the rate of eight percent of earnable compensation after June 30, 1996, the amount of monthly retirement annuity with respect to creditable service rendered after June 30, 1996, shall be equal to two and one-half percent of monthly average final compensation multiplied by the number of years of creditable service rendered after June 30, 1996. For each member who elects as of July 1, 1996 to increase his contribution from five percent to seven percent of earnable compensation, the amount of retirement annuity with respect to creditable service rendered after June 30, 1996, shall be equal to two percent of monthly average final compensation multiplied by the number of years of creditable service rendered after June 30, 1996. For each member who elects as of July 1, 1996 to increase his contribution rate to seven percent or eight percent of earnable compensation, the amount of retirement annuity with respect to creditable service rendered after September 30, 1979 but before July 1, 1996 shall be equal to one and two-thirds percent, if prior to July 1, 1996 he had been contributing at the rate of five percent, or two percent, if prior to July 1, 1996 he had been contributing at the rate of seven percent, of monthly average final compensation multiplied by the number of years of creditable service rendered after September 30, 1979 but prior to July 1, 1996. The foregoing election periods shall expire on July 31, 1996 and may not be extended for any reason. For each member who contributes at the rate of five percent of earnable compensation on and after February 1, 2003, the amount of monthly retirement annuity with respect to creditable service rendered on and after February 1, 2003 shall be equal to two percent of the monthly average final compensation multiplied by the number of years of creditable service rendered on and after February 1, 2003. For each member who contributes at the rate of six percent of earnable compensation on and after February 1, 2003, the amount of monthly retirement annuity with respect to creditable service rendered on and after February 1, 2003 shall be equal to two and one-half percent of the monthly average final compensation multiplied by the number of years of creditable service rendered on and after February 1, 2003. In no event shall the total annuity as computed above for any member exceed 60 percent of the monthly average final compensation.

For members who are not police officers or senior management employees, effective October 1, 2016:

- (i) For each member who contributes at the rate of eight percent (8%) of earnable compensation, the amount of monthly retirement annuity with respect to creditable service rendered on and after October 1, 2016 shall be equal to two and eight-tenths percent (2.8%) of monthly average final compensation multiplied by the number of years of creditable service rendered on and after October 1, 2016;
- (ii) For the member who contributes at the rate of seven percent (7%) of earnable compensation, the amount of monthly retirement annuity with respect to creditable service rendered on and after October 1, 2016 shall be equal to two and sixty-five one hundredths percent (2.65%) of monthly average final compensation multiplied by the number of years of creditable service rendered on and after October 1, 2016; and
- (iii) In no event shall the total annuity as computed above for any member exceed ~~sixty-eight~~ eighty percent (68% 80%) of monthly average final compensation, effective January 1, 2020.

Section 3. SECTION 2-192, Cost-of-living adjustment for retired members and their beneficiaries, is hereby amended and to be read as follows:

Sec. 2-192. - Cost-of-living adjustment for retired members and their beneficiaries.

- (a) The purpose of this section is to provide a cost-of-living adjustment to the benefits payable to retired members on or after January 1, 2004 and their beneficiaries.
- (b) Commencing on the first day of January, 2004 and on the first day of each January thereafter, the benefit of each retired member or beneficiary shall be adjusted as follows:
 - (1) The amount of the monthly benefit payable for the 12-month period commencing on the first adjustment date shall be the amount of the monthly benefit plus one and one-half percent. The amount of the monthly benefit payable for subsequent twelve-month periods shall be the amount of the monthly benefit being received on January 1 immediately preceding the adjustment date plus an amount equal to one and one-half percent of said benefit. Effective January 1, 2020, the cost of living benefit shall be two percent (2%) for all members who retire on or after January 1, 2020.

Section 4. All sections or parts of sections of the Town Code, all ordinances or parts of ordinances, and all resolutions or parts of resolutions in conflict herewith, be and the same, are hereby repealed to the extent of such conflict.

Section 5. Should this ordinance or any part thereof be declared invalid by a Court of competent jurisdiction, the invalidity of any part of this ordinance shall not otherwise affect the validity of the remaining provisions of this ordinance, which shall be deemed to have been enacted without the invalid provision.

Section 6. It is the intention of the Commission of the Town of Surfside that the provisions of this ordinance shall become and be made a part of the Code of the Town of Surfside, and that the word "ordinance" may be changed to "section," "article," or such other appropriate word or phrase in order to accomplish such intentions.

Section 7. This ordinance shall become effective upon final passage.

PASSED AND ADOPTED ON FIRST READING, this 10th day of December, 2019 with a 5-0 vote.

PASSED AND ADOPTED ON SECOND READING, this 14th day of January, 2020 with a 5-0 vote.



Daniel Dietch, Mayor

ATTEST:

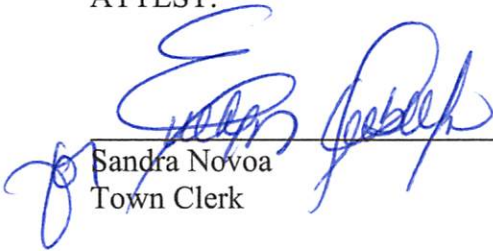

Sandra Novoa
Town Clerk

**APPROVED AS TO FORM AND
LEGAL SUFFICIENCY**



Lillian Arango, Town Attorney

Moved by: Commissioner Karukin

Second by: Commissioner Paul

Vote:

Mayor Dietch	yes <u>X</u>	no ___
Vice Mayor Daniel Gielchinsky	yes <u>X</u>	no ___
Commissioner Barry Cohen	yes <u>X</u>	no ___
Commissioner Michael Karukin	yes <u>X</u>	no ___
Commissioner Tina Paul	yes <u>X</u>	no ___



MEMORANDUM

To: Honorable Mayor, Vice-Mayor and Members of the Town Commission
From: Guillermo Olmedillo, Town Manager
Date: April 20, 2020
Subject: Retirement Plan Funding Ratio

Pursuant to Town Commission's direction at the April 16, 2020 Town Commission meeting regarding the Retirement Plan Funding Ratio, the following information reviews the Funding Ratio comparison:

In 2012, the mortality assumption was updated, this led to a decrease in the Funded Ratio of approximately 0.7%.

In 2013, the Funded Ratio, as reported under GASB, was changed to be the Market Value of Assets divided by the trailing Liability (the liability a year before the actual reporting date) – however, the Funded Ratio below is a Funded Ratio Calculation that our actuarial firm, Gabriel Roeder Smith (GRS) prepared so that a comparison could be made. Using the actuarial report assures an independent statement. (Please note that the Actuarial Value of Assets is a five-year smoothed asset value).

You will notice that from 2008 to 2012 the Funded Ratio decreased 17.3%. From 2012 to 2018 a relatively steady Funded Ratio was maintained.

The main reason for the decrease in Funded Ratio from 2008 to 2012 was the Great Recession. Additionally, the smoothing used in the Asset Value in the Funded Ratio, the impact of the Great Recession on the asset value was not fully reflected out until 5 years after the crisis.

Other factors include:

In 2015, the mortality table was updated, pursuant to Florida Statute, and the investment return assumption was lowered from 7.50% to 7.25% (along with other demographic assumption changes after an experience study was performed). This decreased the Funded Ratio by 1.9%.



Writer's email: adam@robertdklausner.com

Via email: abraham.issa@ubs.com

Abraham Issa, Chairman
Surfside Employees Retirement Plan
c/o Plan Administrator

Mr. Chairman,

This is in response to your request for a legal opinion as to whether the payment of pension benefits is a ministerial duty required as a matter of law. That question is answered in the affirmative. The Board's fiduciary duty to pay benefits when a member has achieved retirement eligibility arises under both state statute and common law.

For nearly a century, courts have held that pension rights in a governmental retirement system are not a mere gratuity. *See Stringer v. Lee*, 2 So. 2d 127 (Fla. 1941). In other words, the rights of governmental employees to timely payment of their pensions is a constitutionally protected contractual right. Once vested in the retirement system by achieving eligibility for retirement as defined in the Plan, benefits cannot be diminished or impaired.

For the reasons described below, were the Board to refuse to comply with the payment obligations set forth in the Plan, retirees would have the right to bring suit for "mandamus" which is a mandatory injunction to compel the Board to abide by its "ministerial" duties.

Article I, Section 10, of the Florida Constitution - and Article I, Section 10 of the United States Constitution - prohibit laws impairing the obligation of contract. In 1933, the Florida Supreme Court concluded the such constitutional protections extend to pension contracts created

7080 NORTHWEST 4TH STREET, PLANTATION, FLORIDA 33317
PHONE: (954) 916-1202 – FAX: (954) 916-1232
www.klausnerkaufman.com

by state and municipal pension statutes and ordinances alike. *See Anders v. Nicholson*, 150 So. 639 (Fla. 1933).

In *State ex rel. Stringer v. Lee*, 2 So. 2d 127 (Fla. 1941) the Florida Supreme Court recognized that “retirement pay is a part of the compensation for services rendered during active employment.” According to the *Stringer* court, once fully vested, a governmental pension establishes a contractual relation which may not be affected or adversely altered by subsequent enactments. In 1956, the Court reasoned that public pensions “raise the standard of government personnel and make government service a career rather than a passing interlude.” *See Greene v. Gray*, 87 So. 2d 504 (Fla. 1956)(holding that public pension are required to be permissively construed).

The law is also clear that the payment of monthly pension benefits is a ministerial duty. *See Scott v. Williams*, 107 So.3d 379 (Fla. 2013); *City of Jacksonville Beach v. O’Donald*, 151 So.2d 430 (Fla. 1963); *O’Connell v. Dept. of Administration*, 557 So. 2d 609 (Fla. 3d DCA 1990). A ministerial duty arises where “there is no room for the exercise of discretion, and the performance being requested is directed by law.” *Board of County Commissioners v. Lori Parrish*, 154 So. 3d 412 (Fla. 4th DCA 2014).

Feel free to advise if you want to discuss any of the legal authorities cited, copies of which will be provided upon request.

Very truly yours,

/s/ Robert D. Klausner
Robert D. Klausner

/s/ Adam P. Levinson
Adam P. Levinson

RD/APL/yv

cc: Mayte Gamiotea, Administrator



MEMORANDUM

ITEM NO. 4AA

To: Honorable Mayor, Vice-Mayor and Members of the Town Commission
From: Guillermo Olmedillo, Town Manager
Date: June 23, 2020
Subject: Increase Lighting Plan

At the March 24, 2020 Special Commission Meeting, Town Administration was directed to provide a plan for the increase of residential street lighting.

Please find attached requested report being provided with this communication.

Reviewed by: HG/RS

Prepared by: HG



Town of Surfside Public Works Department Safer Walkability- Increased Lighting Plan

Update as of March 30th, 2020

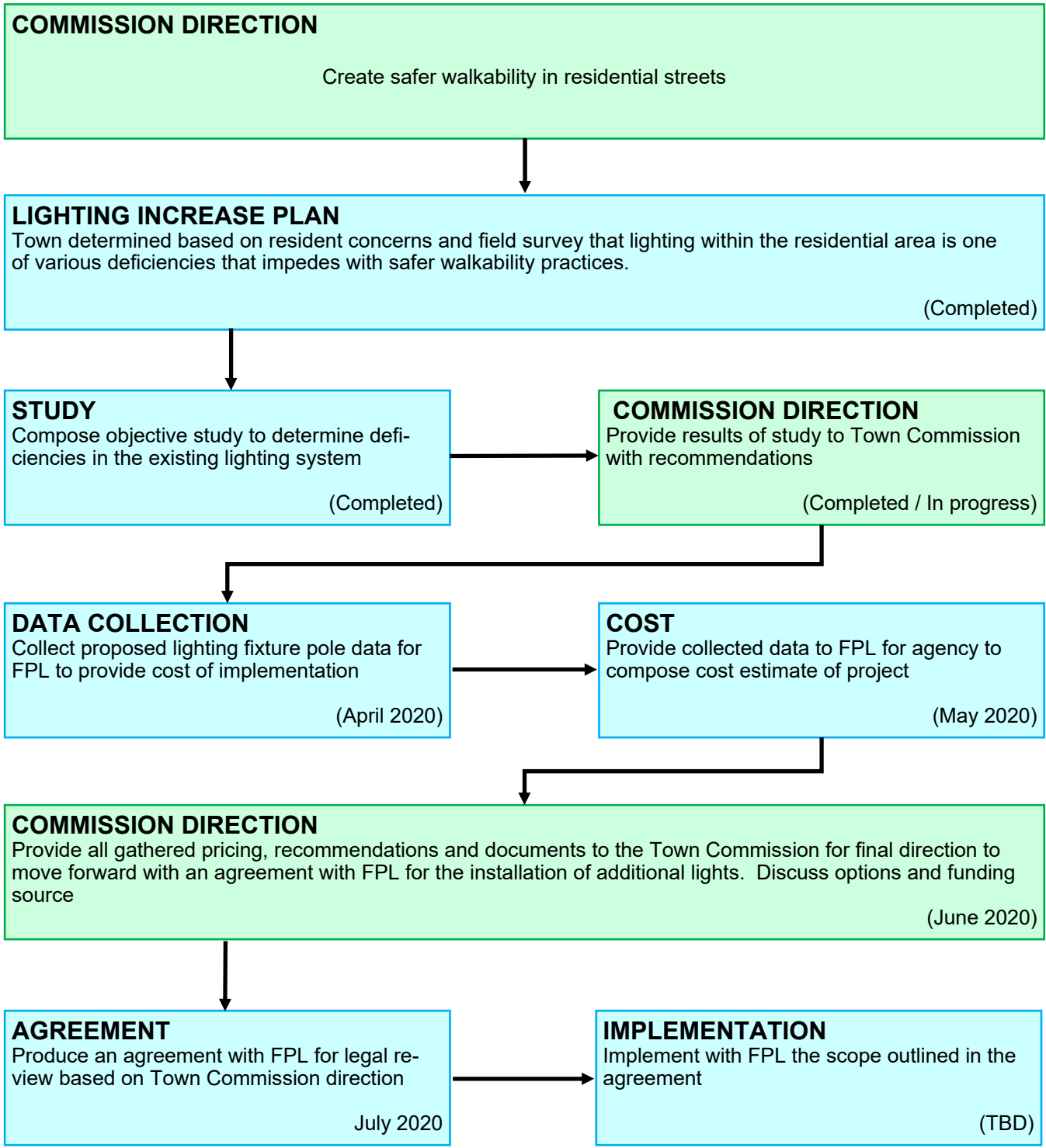



MEMORANDUM

ITEM NO.

To: Honorable Mayor, Vice-Mayor and Members of the Town Commission

From: Guillermo Olmedillo, Town Manager

Date: February 28th, 2020

Subject: Analysis for Determination of Additional Lighting Locations in Residential Areas within the Town of Surfside

The Town of Surfside, in an effort to address pedestrian safety and promote walkability within the Town, recently partnered with Florida Power and Light (FPL) to upgrade all residential street lighting from high pressure sodium bulbs to Light Emitting Diodes (LED). The lighting upgrade project was completed in January 2020 with a total of 236 fixtures changed. After the conversion, the Public Works Department performed various nightly walkthroughs to evaluate the outcome of the conversion. As a result, a 33% increase in illumination per fixture was obtained. This determination was made by comparison of photometrics of both the new LED lighting and high-pressure sodium bulbs. Photometrics is the measurement of lighting. For the comparisons made, photometric data used was the surface coverage of lighting onto asphalt surface from both fixtures, before and after conversion.

Illumination is not uniform throughout the Town. Even after the FPL conversion project, various “dark” areas exist that continue to remain a hazard. The Town administration will proceed to perform an analysis on illumination deficiencies still present. In order to eliminate subjectivity in the determination of the location and number of new light fixtures and or poles to have uniform illumination at the pedestrian level, the Town administration will prepare an analysis that incorporates the following:

1. Use the technical specifications of the equipment in place already obtained from FPL.
2. Use the information that the Town has already collected on the location of light fixtures including previous lighting data.
3. Draw the area illuminated from each lighting fixture, using the technical specifications already obtained.
4. Produce a map (GIS or similar) with the proposed locations of new lights and or poles.

5. Propose a plan to add lights where pedestrian level lighting does not have uniform illumination and deficiencies determined

The proposed plan allows for a non-subjective determination of areas in need of additional lighting. The proposed plan will provide hazard areas based on existing and collected data. An alternative plan to have individuals estimate where additional illumination should go based on visual interpretation can lead to subjective results. The Town administration will move forward with the presented plan of analysis as per Town Commission direction. The results will be reported to the Town Commission through an update.

Reviewed by

Prepared by

TOWN OF SURFSIDE

Public Works Department

“Residential Street Lighting Photometric Analysis and Recommendations”

February 26, 2020

9293 HARDING AVENUE,
SURFSIDE, FL 33154
PHONE: (305) 861-4863

Prepared By:



Public Works Department



TABLE OF CONTENTS

INTRODUCTION	3
OBJECTIVE	4
METHODOLOY	5
ANALYSIS	6
RECOMMENDATION AND CONCLUSION	15

ATTACHMENTS

- Appendix A – *“Town of Surfside Street Light Inventory”*- 1 Page
- Appendix B – *“Product Specification Photometrics”*- 3 Pages
- Appendix C – *“Street Light Photometric”* - 2 Pages
- Appendix D – *“Proposed Street Lights Map”*. - 1 Page



INTRODUCTION

The Town of Surfside is a coastal community within Miami-Dade County with approximately 5,844 residents based on 2017 population figures. The Town has various districts which include commercial high-rise, commercial retail and residential single family. Each of these districts has lighting infrastructure provided by different agencies. **Table A – “Lighting Inventory by Responsible Authority”** below outlines the total quantity of light fixtures per district and the responsible party for lighting maintenance:

Item Number	District	Responsible Party	Total # of Fixtures	Type of Fixture
1	Residential	FP&L	243	LED
2	Downtown Surfside	Town of Surfside	24	LED
3	A1A & Harding Ave	Miami-Dade County	62	High Pressure Sodium
4	Beach Ends	FP&L / Town of Surfside	11	HPS and LED

Table A – “Lighting Inventory by Responsible Authority”

Table A – “Lighting Inventory by Responsible Authority” is composed based on a Geographical Information System (GIS) mapping composed in 2018 by Town Engineer of Record (EOR), Calvin Giordano and Associates (CGA) and confirmed by the Town’s Public Works Department. The GIS map titled “Town of Surfside Street Light Inventory” can be found in **Appendix A – “Town of Surfside Street Light Inventory”**.

In late 2019, the Town of Surfside Commission approved the conversion of High-Pressure Sodium lights (HSP) throughout the residential area to Light Emitting Diode (LED) with the objective of minimizing operating costs for night-time illumination of public right of way and increase effectiveness of illumination. The lighting upgrade project was completed in January 2020 with a total of 236 fixtures changed. After the conversion, the Public Works Department performed various nightly walkthroughs to evaluate the outcome of the conversion. As a result, a 33% increase in illumination per fixture was obtained. This determination was made by comparison of photometrics of both the new LED lighting and high-pressure sodium bulbs. Photometrics is the measurement of lighting. For the comparisons made, photometric data used was the surface coverage of lighting onto asphalt surface from both fixtures, before and after conversion. The photometrics of the previous high sodium pressure bulbs (HPS) and recently installed LED fixtures can be found in **Appendix B – “Product Specification Photometrics”**.

Currently, Florida Department of Transportation (FDOT) is working with Miami-Dade County (MDC) and is scheduled to convert a portion of street lights on A1A and Harding Avenue for fiscal year 2021-2022 to LED. Additionally, the Town of Surfside converted all Town maintained street lights to LED already. During the February 2020 Town Commission meeting, the Town Commission gave direction to the Town Manager to proceed with performing a street lighting analysis in order to determine where additional lights are needed.



OBJECTIVE

Increase the quantity of residential street lighting fixtures with locations non-subjectively selected with the purpose to create safer walkability by increasing illumination during evening hours.

Illumination is not uniform throughout the Town. Even after the conversion project within the residential area, various “dark” areas exist that continue to remain a hazard for walkability during night-time hours. **Picture A** – “*Photograph of Dickens Avenue and 92nd street*” below shows the composition of dark areas and light areas as they pertain to a residential street block within the Town.



Picture A – “*Photograph of Dickens Avenue and 92nd street*”

The Town Administration performed an analysis based on information gathered and field visits in order to increase the quantity of residential street lighting fixtures with locations non-subjectively selected with the purpose of creating safer walkability by increasing illumination



during evening hours. Furthermore, a **Recommendation and Conclusion** section is provided in this analysis report to assist with Town Commission direction decision.

METHODOLOGY

In order to eliminate subjectivity in the determination of the location and number of new light fixtures to have uniform illumination at the pedestrian level, the analysis by Town administration incorporated the following items:

- Use the technical specifications of the equipment in place already obtained from FPL. This involved the comparison of photometric charts of both HPS bulbs and LED fixtures which are included in **Appendix B** – *“Product Specification Photometric”*.
- Use the information that the Town has already collected on the location of light fixtures including previous lighting data in order to overlay photometric chart data onto existing GIS maps provided in **Appendix A** – *“Town of Surfside Street Light Inventory”*.
- Draw the area illuminated from each lighting fixture, using the technical specifications already obtained onto in **Appendix A** – *“Town of Surfside Street Light Inventory”* in order to create **Appendix C** – *“Street Light Photometric”*.
- Produce a map (GIS or similar) with the proposed locations of new lights and or poles after item number 1, item number 2 and item number 3 have been evaluated. **Appendix D** – *“Proposed Street Lights Map”*.

Based on the findings, **Table C** – *“Recommendation Table”* was composed which incorporates the findings of the analysis and makes various illumination goals depending on the number of lighting fixtures proposed. This analysis does not include cost figures or cost estimates.



ANALYSIS

The analysis for residential street light photometric is provided in this section. The analysis is based on the proposed methodology that was presented to the Town Commission during the February 2020 Town Commission General Meeting.

Use the technical specifications of the equipment in place already obtained from FPL. This involved the comparison of photometric charts of both HPS bulbs and LED fixtures which are included in **Appendix B – “Product Specification Photometrics”**.

Both photometric data for high pressure sodium bulbs and LED fixtures were compared side by side. Two distances were obtained for each lighting system; these are the longitudinal distance and width distance. Longitudinal distance is referring to the distance on each side of the fixture and width distance is the distance in front of the fixture. Both distances vary depending on the height of the fixture installation. Based on the information gathered from product specification photometrics, **Table B – “Lighting Coverage by Fixture”** below was composed to present findings.

Item Number	Type of Fixture	Longitudinal Distance (Feet)	Width Distance (Feet)	Finding Source
1	High Pressure Sodium	50	40	Field Measurement
2	High Pressure Sodium	70	50	Specification Sheet
3	LED	85	40	Field Measurement
4	LED	75	20	Specification Sheet

Table B – “Lighting Coverage by Fixture”

Table B – “Lighting Coverage by Fixture” also presents field measurements of each fixture as there was a difference in field conditions to product specification conditions. The difference was the height of installation. The Town of Surfside has fixtures installed higher than presented in product specification by a total of 5 feet with a margin of error of 3 feet. Based on findings, an average of both measurements was taken and presented in **Table C – “Lighting Coverage by Fixture Average”** as shown below:

Item Number	Type of Fixture	Longitudinal Distance (Feet)	Width Distance (Feet)	Finding Source
1	High Pressure Sodium	60	45	Average
2	LED	80	30	Average

Table C – “Lighting Coverage by Fixture Average”



It is worth noting that the figures present are the effective lighting of each light based on their design intent. Each fixture covers areas greater than shown in **Table B** – “*Lighting Coverage by Fixture*” but these areas are dimmer and not effective lighting areas. Secondly, **Appendix B** – “*Product Specification Photometrics*” provides photometrics in a disformed shape which resembles a dis-figured circle. For the purpose of this analysis, the photometric impact area was averaged and converted to a defined semi-circle. **Picture B** – “*Photometric Impact Area*” below presents the averaged fixture coverage area that was used for the analysis.

DIMENSIONS

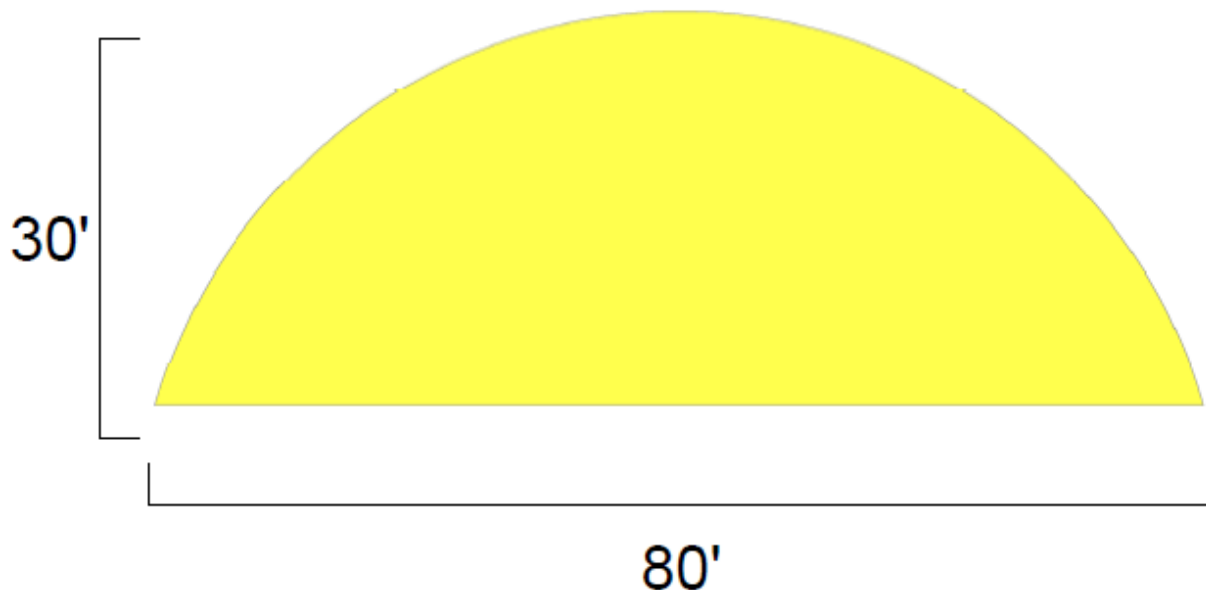

Picture B – “*Photometric Impact Area*”

Picture B – “*Photometric Impact Area*” will be referred to as the illumination zone for the remainder of the analysis. It was used as an overlay onto residential street maps in order to determine areas that are not receiving effective illumination coverage. Furthermore, there is a 6-foot to 8-foot offset from above ground utility poles to light figure (light source) which is due to the arm length of each lighting fixture. This distance was taken into consideration. Lastly, non-effective lighting behind each lighting fixture was not taken into account. This is because these areas are not considered walkable areas and are of private property majority. Additionally, measurements of these areas illumination by LED lighting fixtures is difficult due to private property lighting distortion.



Use the information that the Town has already collected on the location of light fixtures including previous lighting data in order to overlay photometric chart data onto existing GIS maps provided in **Appendix A** – “Town of Surfside Street Light Inventory”. Draw the area illuminated from each lighting fixture, using the technical specifications already obtained onto in **Appendix A** – “Town of Surfside Street Light Inventory” in order to create **Appendix C** – “Street Light Photometric”.

Appendix A – “Town of Surfside Street Light Inventory” was used to assess the areas currently obtaining illumination and compared to the areas not receiving. Based on findings, there are currently an average of 3.00 lighting fixtures per block. Page 2 of **Appendix A** – “Town of Surfside Street Light Inventory”, lays out a typical section of a Town block. A Town block from street to street along the same avenue in the residential area is approximately 525 linear feet. Based on the average amount of lights, a total of 240 linear feet out of the entire 525 linear feet of a typical block has illumination. Therefore, it was determined that the average lighting per typical block is approximately 45%. **Diagram A** – “Typical Lighting Per Block Diagram”, below creates a visual representation of the 45% illumination of an average typical roadway.



Diagram A – “Typical Lighting Per Block Diagram”

In **Diagram A** – “Typical Lighting Per Block Diagram”, the entire strip represents a typical block along an avenue from street to street. For example, Garland Ave from 89th Street to 90th Street. The yellow sections represent the illumination zone. The black sections represent the areas where minimal to no illumination is present. Since this is an average representation of actual field conditions, it has been simplified for analysis purposes. As previously stated, even though the average coverage per existing LED fixture is 40 feet each way (80 feet total), the fading effect of each fixture may add additional coverage. The fading effect is the dimming of the illumination as the distance from the point of origin increases. The fading effect distance was not used in the analysis because it is not considered optimal illumination. The following pictures provide a reality perspective to **Diagram A** – “Typical Lighting Per Block Diagram”.



Picture C – *“Town of Surfside Night-time Aerial on 02-21-2020”*



Picture D – “Town of Surfside Night-time Aerial on 02-21-2020 “



Produce a map (GIS or similar) with the proposed locations of new lights and or poles after item number 1, item number 2 and item number 3 have been evaluated. **Appendix D** – “Proposed Street Lights Map”.

Propose a plan to add lights where pedestrian level lighting does not have uniform illumination and deficiencies determined.

During the evaluation of all information, it was determined that 45% of the single-family residential areas right of way within the Town are illuminated. This is based on the lighting illumination per street as an average. Prior to determining locations of additional lights, various variables needed to be considered. The considerations are as follows:

- Number of existing above ground utility poles existing
- Number of existing above ground utility poles with transformers
 - a. Accessibility to transformers if a proposed pole does not have one
 - b. Capacity of transformer
- Location of street where poles are located and if cross alternation can take place (each side of the street)
- Illumination percentage goal

45% existing illumination was based on 3 lighting fixtures per block average. In order to increase illumination, new lighting fixtures need to be added. The current infrastructure allows for additional lighting fixtures since poles either have a transformer or, are within the proximity of a pole with a transformer. To be within the proximity, the nearest pole with transformer needs to be within 2 poles distance. The current lighting fixture spread alternates with every other pole having a fixture. On average, a residential block has 6 poles and 2 transformers.

Based on two neighborhoods surveyed with optimal lighting, 90% illumination was the targeted percentage goal. 90% allows for illumination visibility throughout as lighting transition from one lighting fixture to the next. The 2 neighborhoods surveyed had the same single-family residential style as Town of Surfside. The neighborhoods were as follows:

- North Bay Village – Single Family Residential Area
- Normandy Isle, Miami Beach Single Family Residential Area

Appendix D – “Proposed Street Lights Map” proposes a total of 133 new fixtures along street blocks in the residential area in order to achieve 90% illumination. This figure breaks



down to an additional 3 fixtures per Town block. In the creation of **Appendix D** – “Proposed Street Lights Map”, some Town blocks have proposed 2 additional lighting fixtures and other more than 3 additional lighting fixtures. Even though the average is 3 additional light fixtures per block, some have proposed less since there is an intersection pole that provides block illumination. All proposed locations have an existing pole so only fixture and connection to a transformer are needed. For the most part, all transformers have the capacity for additional lighting fixture. Transformer capacities need to be confirmed with FP&L. The following pictures show areas within Miami-Dade County (MDC) with 90% illumination. The same logic for determination of light percentage in Town of Surfside as used to determine illumination percentages in these areas.



Picture E – “North Bay Village Night-time Aerial on 02-21-2020”



Picture F – “Normandy Isles Night-time Aerial on 02-21-2020”



Picture G – “Normandy Isles Night-time Aerial on 02-21-2020”



RECOMMENDATION AND CONCLUSION

The analysis was based on 90% illumination which is the maximum number of lighting fixtures to existing poles. **Table C** – “*Recommendation Table*” presents the number of additional fixtures with respective illumination percentage for various options. Refer to table below:

Item number	Number of Additional Lights (Overall)	Average Additional Lights per Block	Illumination Percentage	Comments
1	0	3	45%	No Change
2	89	4	60%	N/A
3	112	5	76%	N/A
4	133	6	90%	Appendix D

Table C – “*Recommendation Table*”

At this time, there is no cost estimate for each of the recommendations of **Table C** – “*Recommendation Table*”. Cost estimate will involve coordination with Florida Power and Light (FP&L). Currently, the provided recommendations are based on using existing pole infrastructure. Based on Town Commission direction, a cost estimate can be composed for proposed recommendation options. Any cost estimates pertaining to light fixtures operated by another agency need to be coordinated. In this case, cost estimate needs to be coordinated with Florida Power and Light (FPL).

Some additional considerations include:

- How will additional lighting fixtures in the Right of Way impact the quality of life of residents.
 - Light infiltration into private property
- Other options for increase walkability safety
 - Mid-level pedestrian lighting options
 - Alternative walking options such as sidewalks
 - Enhancing other infrastructure options such as;
 - Thermoplastic striping of roadway markings
 - Roadway Lighting options which include ground and signage lighting

This report was composed using the existing infrastructure present to add additional lighting fixtures to gain an increase in illumination percentage. The proposed locations of the lighting fixtures were based on existing locations of above ground utility poles.





Appendix A



“Town of Surfside Street Light Inventory”

1 Page

Legend

-  City Boundary
-  Parcels

Owner

-  Surfside
-  FPL
-  Miami-Dade County



Town of Surfside Street Light Inventory

Print Date: 11/7/2018

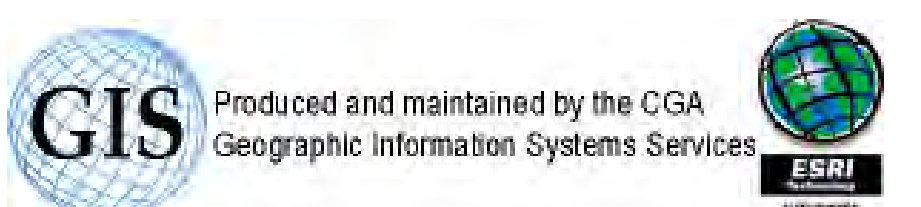
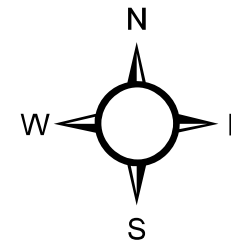



Appendix B

“Product Specification Photometric”

3 Pages

Photometric Data

E-17 High Pressure Sodium

BK No.	Lamp Watts	Description	Rated Life	Initial Lumens	Mean Lumens	CRI	CCT(K)
112	35	35W/E-17/HPS/MED/Clear	24,000	2,250	2,025	20	2,100
113	35	35W/E-17/HPS/MED/Diffuse	24,000	2,150	1,935	20	2,100
104	50	50W/E-17/HPS/MED/Clear	24,000	4,000	3,600	21	2,100
105	50	50W/E-17/HPS/MED/Diffuse	24,000	3,800	3,420	21	2,100
108	70	70W/E-17/HPS/MED/Clear	24,000	6,300	5,670	21	2,100
109	70	70W/E-17/HPS/MED/Diffuse	24,000	5,860	5,270	21	2,100
120	100	100W/E-17/HPS/MED/Clear	24,000	9,500	8,550	21	2,100
121	100	100W/E-17/HPS/MED/Diffuse	24,000	8,800	7,920	21	2,100
122	150	150W/E-17/HPS/MED/Clear	24,000	16,000	14,400	21	2,100
123	150	150W/E-17/HPS/MED/Diffuse	24,000	15,000	13,500	21	2,100

Lumen & Candela Conversion Multipliers	
100W	.60
70W	.40
50W	.25
35W	.14

NARROW SPOT

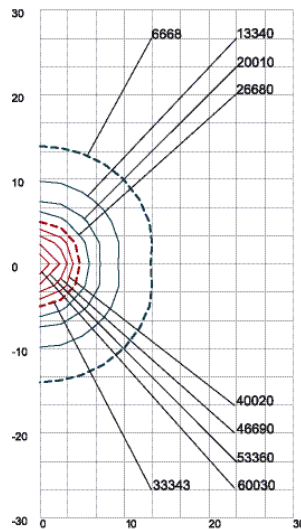

B-K FILENAME : TY11-150-NS-HPS CLEAR-ITLIES
 Lamp: 150W Clear B-17 High Pressure Sodium
 IES Beam Type: 24 x 2V
 Max. Candela: 6668 at 0°H 0°V
 Beam Spread (at 50% Max CD): 33343 at 10°H 10°V
 Field Spread (at 10% Max CD): 6668 at 28°H 28°V
 Total Lumens: 3237

SPOT

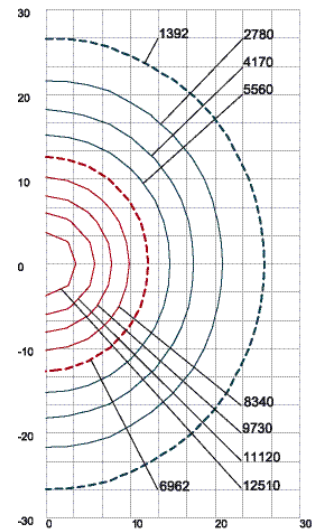

B-K FILENAME : TY11-150-SP SPECULAR-HPS CLEAR-ITLIES
 Lamp: 150W Diffuse B-17 High Pressure Sodium
 IES Beam Type: 44 x 4V
 Max. Candela: 1392 at 0°H 0°V
 Beam Spread (at 50% Max CD): 6962 at 24°H 25°V
 Field Spread (at 10% Max CD): 1392 at 51°H 53°V
 Total Lumens: 3859

FLOOD

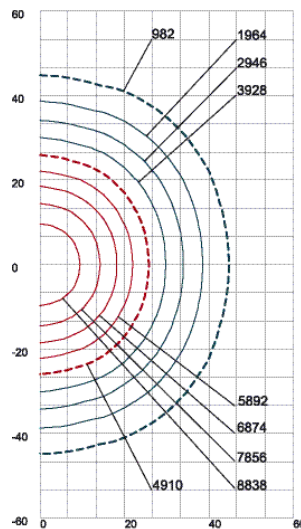

B-K FILENAME : TY11-150-FL-HPS COATED-ITLIES
 Lamp: 150W Diffuse B-17 High Pressure Sodium
 IES Beam Type: 54 x 5V
 Max. Candela: 982 at 0°H 0°V
 Beam Spread (at 50% Max CD): 4910 at 52°H 52°V
 Field Spread (at 10% Max CD): 982 at 90°H 90°V
 Total Lumens: 3237

WIDE FLOOD

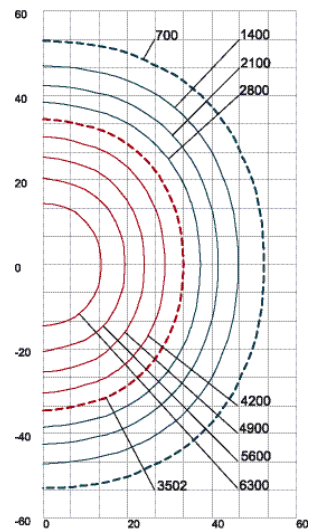

B-K FILENAME : TY11-150-WF-HPS COATED-ITLIES
 Lamp: 150W Diffuse B-17 High Pressure Sodium
 IES Beam Type: 84 x 6V
 Max. Candela: 700 at 0°H 0°V
 Beam Spread (at 50% Max CD): 3502 at 67°H 66°V
 Field Spread (at 10% Max CD): 700 at 105°H 106°V
 Total Lumens: 8559

Photometric Toolbox

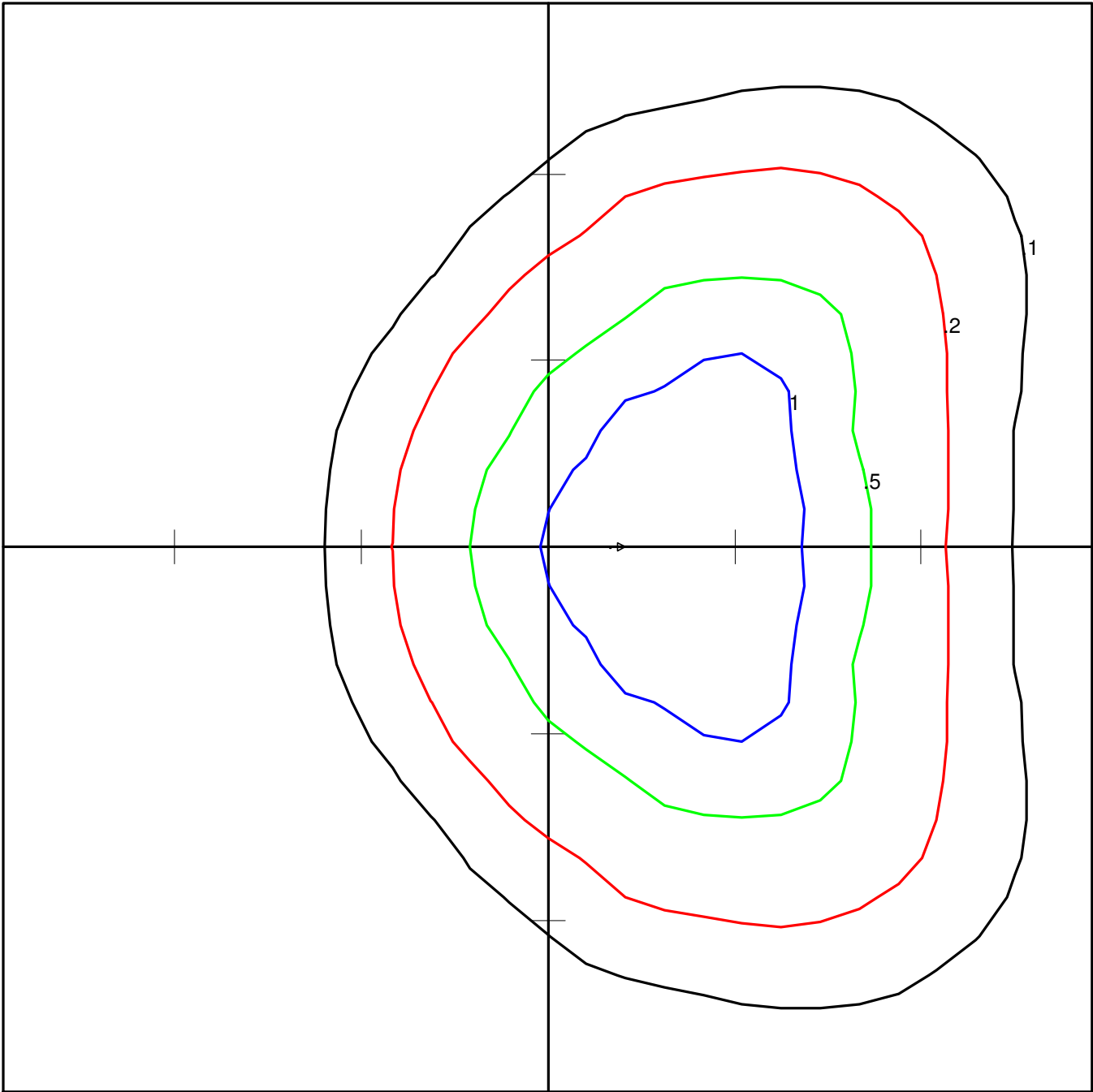

Cree, Inc
 RSWS-A-HT-3ME-5L-30K7-UL-xxxx
 Formed BMC housing, prismatic plastic lens, white inner
 reflector
 24 white LEDs

Horizontal Footcandles
 Scale: 1 Inch = 20 Ft.
 Light Loss Factor = 1.00
 Lumens Per Lamp = N.A. (absolute photometry)
 Luminaire Lumens = 5000
 Mounting Height = 24.00 Ft
 Maximum Calculated Value = 1.74 Fc
 Arrangement: Single
 Arm Length = 8 Ft





Appendix C



“Street Light Photometric”

2 Pages

Legend

-  City Boundary
-  Parcels
-  Illumination Zones

Owner (Count)

-  Surfside (83)
-  FPL (243)
-  Miami-Dade County (68)

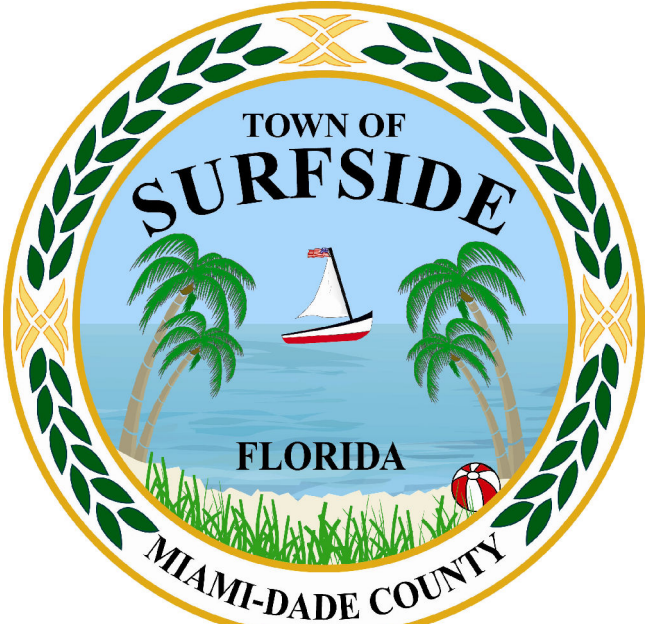

Town of Surfside Street Light Inventory

Print Date: 2/3/2020

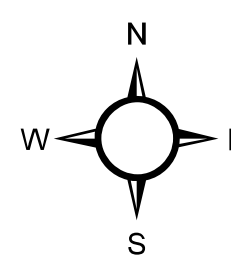

200
Feet

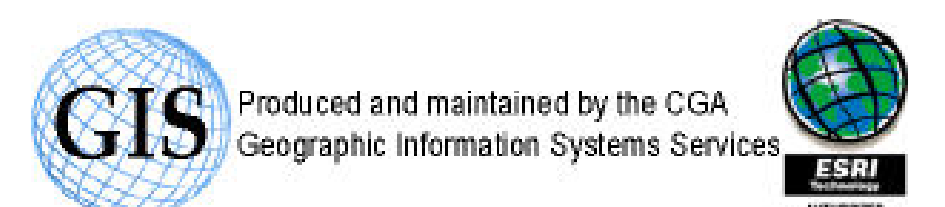







Appendix D





“Proposed Street Lights Map”

1 Page

Legend

-  City Boundary
-  Parcels
-  FPL Illumination Zones
-  Proposed Illumination Zones

Owner (Count)

-  Proposed (133)
-  Surfside (83)
-  FPL (243)
-  Miami-Dade County (68)



Town of Surfside Street Light Inventory

Print Date: 2/18/2020

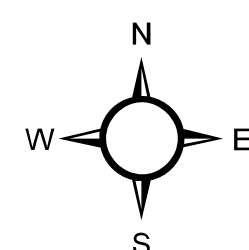

400

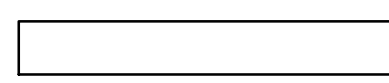

Feet

1 inch = 200 feet



Produced and maintained by the CGA
Geographic Information Systems Services



Calvin, Giordano & Associates, Inc.
EXCEPTIONAL SOLUTIONS™



MEMORANDUM

ITEM NO. 4CC

To: Honorable Mayor, Vice-Mayor and Members of the Town Commission
From: Guillermo Olmedillo, Town Manager
Date: April 21, 2020
Subject: Lowering of Property taxes and Water Bills

At the March 24, 2020 Special Commission Meeting, Town Administration was directed to provide information on lowering property taxes and water bills.

April 14 through April 21, the Town's Finance Director has meet with the Commissioners to discuss the state of the Town's finances including the financial position of the Town's General Fund and Water & Sewer Fund. With the budget season starting, the Commission will have the opportunity to provide policy direction which forms the basis of the Town's Budget. On June 1, 2020, the Town will receive the Miami-Dade Property Appraiser Assessment Roll Estimate which will help guide the Town's Administration toward the goal of lowering the financial impact to Town residents.

Attached is the Town's financial position presentation given to the Commissioners.

Reviewed by: GO

Prepared by: JDG

FINANCE ORIENTATION

April 2020



Surfside Finance Department

Financial Reporting

Page 312

- Fiscal Year = October 1st thru September 30th
- Comprehensive Annual Financial Report (CAFR)
- Government Finance Officers Association (GFOA)
 - Certificate of Achievement for Excellence in Financial Reporting Program
 - <https://www.gfoa.org/best-practices>



Other Reports

- **Florida Department of Finance**
 - Annual Financial Report (AFR)
- **Florida Auditor General**
 - Local Government Audit Report
- **State and/or Federal Single Audit Report**
- **Office of the Citizens' Independent Transportation Trust**
 - Audit every 5 years
 - Reporting quarterly and annually
- **Federal and State Law Enforcement**
 - Police Forfeiture funds
- **Local Highway Finance Report**
 - State revenue sharing

Fund Accounting

What is a Fund?

- A fund is like having a different checking account for different purposes



Types of Funds



Governmental



Proprietary



Fiduciary



Internal
Service

Governmental Funds

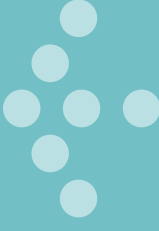

General Fund

Accounts for revenues including property taxes, sales taxes, and fines, as well as expenditures like Police and General Government

Special Revenue Funds

Used for revenue sources that can only be used for a specific purpose (ex. Building, Resort Taxes)

Capital Project Fund

Accounts for major capital construction or acquisition of major assets

Other Funds

Proprietary Funds

- Government services that are financed in whole or in part by fees paid by those who benefit from the services



Fiduciary Fund

- Used when a government unit acts as a trustee or agent



Internal Service Fund

- Accounts for cost of maintaining Town's fleet



Balance Sheet - Reserves

- The Town is in good financial position
- General Fund (2019 UNAUDITED)
 - \$2.0M assigned fund balance (Hurricane Reserve)
 - New Resiliency Reserve created in FY 2020
 - \$13.0M unrestricted fund balance
- Other governmental funds (Restricted or Assigned)
 - Building Fund \$2.6M
 - Capital Projects Fund \$3.0M
 - Tourist Resort \$1.6M
 - Other (Trans./Police) \$435k
- Enterprise funds (Restricted)
 - Water & Sewer (\$1.5M)
 - Stormwater \$3.2M
 - Parking \$1.2k
 - Solid Waste \$655k

Unassigned General Fund Reserves

Fiscal Year	Amount	Increase	Increase
2009	\$ 7,178,552		
2010	\$ 867,867	\$ (6,310,685)	-87.9%
2011	\$ 1,958,783	\$ 1,090,916	125.7%
2012	\$ 3,121,636	\$ 1,162,853	59.4%
2013	\$ 3,151,275	\$ 29,639	0.9%
2014	\$ 4,204,273	\$ 1,052,998	33.4%
2015	\$ 3,722,284	\$ (481,989)	-11.5%
2016	\$ 5,170,003	\$ 1,447,719	38.9%
2017	\$ 6,460,802	\$ 1,290,799	25.0%
2018	\$ 8,902,050	\$ 2,441,248	37.8%
2019	\$ 12,983,069	\$ 4,081,019	45.8%

General Fund Reserves compared to Property Tax Revenues

Fiscal Year	Reserves	Revenues	% Ratio
2009	\$ 7,178,552	\$ 6,325,721	113.5%
2010	\$ 867,867	\$ 5,323,728	16.3%
2011	\$ 1,958,783	\$ 5,619,494	34.9%
2012	\$ 3,121,636	\$ 5,264,387	59.3%
2013	\$ 3,151,275	\$ 5,257,726	59.9%
2014	\$ 4,204,273	\$ 5,660,551	74.3%
2015	\$ 3,722,284	\$ 6,526,267	57.0%
2016	\$ 5,170,003	\$ 7,276,466	71.1%
2017	\$ 6,460,802	\$ 8,167,329	79.1%
2018	\$ 8,902,050	\$ 9,626,611	92.5%
2019	\$ 12,983,069	\$ 12,835,787	101.1%

Enterprise Funds Unrestricted Reserves

Fiscal Year	Water & Sewer	Stormwater	Solid Waste	Parking
2009	\$ 448,793	\$ (77,137)	\$ (128,427)	\$ 2,526,724
2010	\$ 440,000	\$ 40,626	\$ 82,210	\$ 2,043,034
2011	\$ 1,674,603	\$ 188,302	\$ 207,462	\$ 1,385,581
2012	\$ (2,949,483)	\$ (161,489)	\$ 228,437	\$ 1,258,325
2013	\$ (5,261,333)	\$ 2,520,512	\$ 227,274	\$ 1,066,574
2014	\$ (3,501,884)	\$ 3,838,412	\$ 116,662	\$ 1,000,355
2015	\$ (2,705,871)	\$ 4,051,768	\$ 340,391	\$ 1,089,165
2016	\$ (1,489,769)	\$ 3,626,325	\$ 245,941	\$ 1,111,941
2017	\$ (3,048,579)	\$ 1,456,556	\$ 429,743	\$ 811,013
2018	\$ (2,546,398)	\$ 3,203,878	\$ 601,201	\$ 943,315
2019	\$ (1,477,313)	\$ 3,200,646	\$ 655,448	\$ 1,185,311
2020	\$ (1,136,724)	\$ 3,034,923	\$ 432,957	\$ 1,108,943

Debt

- **No General Obligation, Capital Leases, or Pension Obligation debt**
- **Utility System Revenue Bond Series 2011**
 - Improvements to facilities for the water, sewer, and stormwater systems
 - \$16M issued
 - \$7.3M outstanding as of September 30, 2019
 - Final payment – 2026
- **Clean Water State Revolving Loan**
 - Improvements to facilities for the sewer and stormwater systems
 - \$9.31M issued
 - \$6.86M outstanding as of September 30, 2019
 - Final payment – 2033

***all debt serviced with water, sewer, & stormwater funds**

Budgeting

FISCAL YEAR 2020



Budget Glossary

- Budget:** A plan of financial activity for a specified period of time (fiscal year) indicating all planned revenues and expenses for the budget period.
- **Millage:** Derived from a Latin word "millesimum" meaning "thousandth," with 1 mill being equal to 1/1,000th of a currency unit. As used in relation to property tax, 1 mill is equal to \$1 in property tax, which is levied per every \$1,000 of a property's determined taxable value.
 - **Taxable Valuation:** This is the amount determined by the Property Appraiser after any discounts and/or exemptions have been applied to the assessed valuation. This reduced figure is the one against which governments may levy a tax.

Budget Process

- Budget development and management is a year-round process.
- Budget preparation begins in February-March and is designed to assist the Town's management in the development of short-term and long-term strategies to meet legal and policy directives as well as perceived wishes of the community including the various advisory boards and committees.
- The policy directives of the Town of Surfside's Town Commission are the principal focus of each budget process.
- Government Finance Officers Association (GFOA) Distinguished Budget Presentation Award



Budget Timeline

- **March** Initiate Budget Development Process
- **April** Distribute budget package to Department Directors
- **April** Budget Goals and Objectives Workshop with Town Commission to set budget priorities
- **April-May** Budget Retreat – Town Manager and Department Directors
- **May** Departments submit budget requests. Meetings with Town Manager to review all requests
- **June 1st** Miami-Dade Property Appraiser Assessment Roll Estimate
- **June** Town Commission Budget Workshop

Budget Timeline

- **July 1st** “Certification of Taxable Value” received from the Property Appraiser
- **Early July** Proposed Budget submitted to Town Commission
- **Mid-July** Town Commission meets to set tentative property millage rates
- **Early Aug** Notify Property Appraiser - proposed millage rate, etc.
- **July-Aug** Proposed Budget finalized based on Town Commission budget discussion and final taxable value
- **Sept** First and second public hearings
 - Adopt millage rates
 - Adopt operating and capital budgets

*Florida Statute precludes local governments from conducting its budget hearings on the same date as Miami-Dade County and the Miami-Dade County School Board

Budget Components

General Fund

- General Government
- Public Safety
- Physical Environment
- Streets
- Non-Community Center Parks & Recreation

Special Revenue Funds

- Building Services
- Tourist
- Transportation
- Police Forfeiture

Capital Projects Fund

- Physical Environment

Enterprise Funds

- Water & Sewer
- Stormwater
- Solid Waste
- Parking

Internal Service Fund

- Fleet Management

Special Revenue Funds – What do you get?

• Page 328

• **Transportation Fund**

- Generated through the Miami-Dade County half-penny sales surtax
- Use of the funds include a Community Bus Service as well as sidewalk replacements, bus stop maintenance, etc.
- **Police Forfeiture**
- Funded through forfeitures, seizures, and confiscations related to criminal activity
- Use of the funds is restricted to crime prevention initiatives

• **Building Fund**

- Account for the building department activities
- Revenues are collected from development activity to fund building department operations

Special Revenue Funds – What do you get?

- **Tourist Resort Fund**

Page 329

- Generated from taxes placed on certain types of private enterprise – food and beverage sales and accommodations
- Sixty-six percent (66%) of total revenues allocated for the cost of operating the Community Center and collection of resort tax
- Pursuant to Chapter 67-930 of State of Florida law, and further defined in the Town's Ordinance No. 11-1574, a minimum of 34% of the resort tax revenue must be used to promote the Town as a tourist destination
- The expenditure of these funds is governed by the Tourist Bureau Board
- Used to fund the other initiatives, also enjoyed by residents:
 - Annual holidays lights on Harding Avenue
 - Popular events, including Third Thursdays, First Fridays, Paddletopia, Bootcamp & Brews, History Tours, and more

Community Center Budget is ~\$2.2M in Fiscal Year 2020

This funding provides property tax relief as these operations are no longer supported by the General Fund

Property Values

Taxable Property

Fiscal Year	Millage Rate	Value	Value Increase	% Increase
2009	4.7332	\$ 1,531,669,419		
2010	4.7332	\$ 1,283,401,231	\$ (248,268,188)	-16.2%
2011	5.6030	\$ 1,062,959,623	\$ (220,441,608)	-17.2%
2012	5.5000	\$ 1,017,658,274	\$ (45,301,349)	-4.3%
2013	5.3000	\$ 1,062,214,226	\$ 44,555,952	4.4%
2014	5.2000	\$ 1,144,071,250	\$ 81,857,024	7.7%
2015	5.0293	\$ 1,336,876,007	\$ 192,804,757	16.9%
2016	5.0293	\$ 1,502,755,220	\$ 165,879,213	12.4%
2017	5.0144	\$ 1,689,439,338	\$ 186,684,118	12.4%
2018	4.8000	\$ 2,150,458,492	\$ 461,019,154	27.3%
2019	4.5000	\$ 3,086,020,534	\$ 935,562,042	43.5%
2020	4.4000	\$ 3,116,633,395	\$ 30,612,861	1.0%

Property Taxes

Fiscal Year	Millage Rate	Taxable Property Value	Property Taxes Collected	% Increase
2009	4.7332	\$ 1,531,669,419	\$ 6,325,721	
2010	4.7332	\$ 1,283,401,231	\$ 5,323,728	-15.8%
2011	5.6030	\$ 1,062,959,623	\$ 5,619,494	5.6%
2012	5.5000	\$ 1,017,658,274	\$ 5,264,387	-6.3%
2013	5.3000	\$ 1,062,214,226	\$ 5,257,726	-0.1%
2014	5.2000	\$ 1,144,071,250	\$ 5,660,551	7.7%
2015	5.0293	\$ 1,336,876,007	\$ 6,526,267	15.3%
2016	5.0293	\$ 1,502,755,220	\$ 7,276,466	11.5%
2017	5.0144	\$ 1,689,439,338	\$ 8,167,329	12.2%
2018	4.8000	\$ 2,150,458,492	\$ 9,626,611	17.9%
2019	4.5000	\$ 3,086,020,534	\$ 12,835,787	33.3%
2020	4.4000	\$ 3,116,633,395	\$ 13,027,528	1.5%

TAXABLE VALUES & MILLAGE RATES

10 YEARS

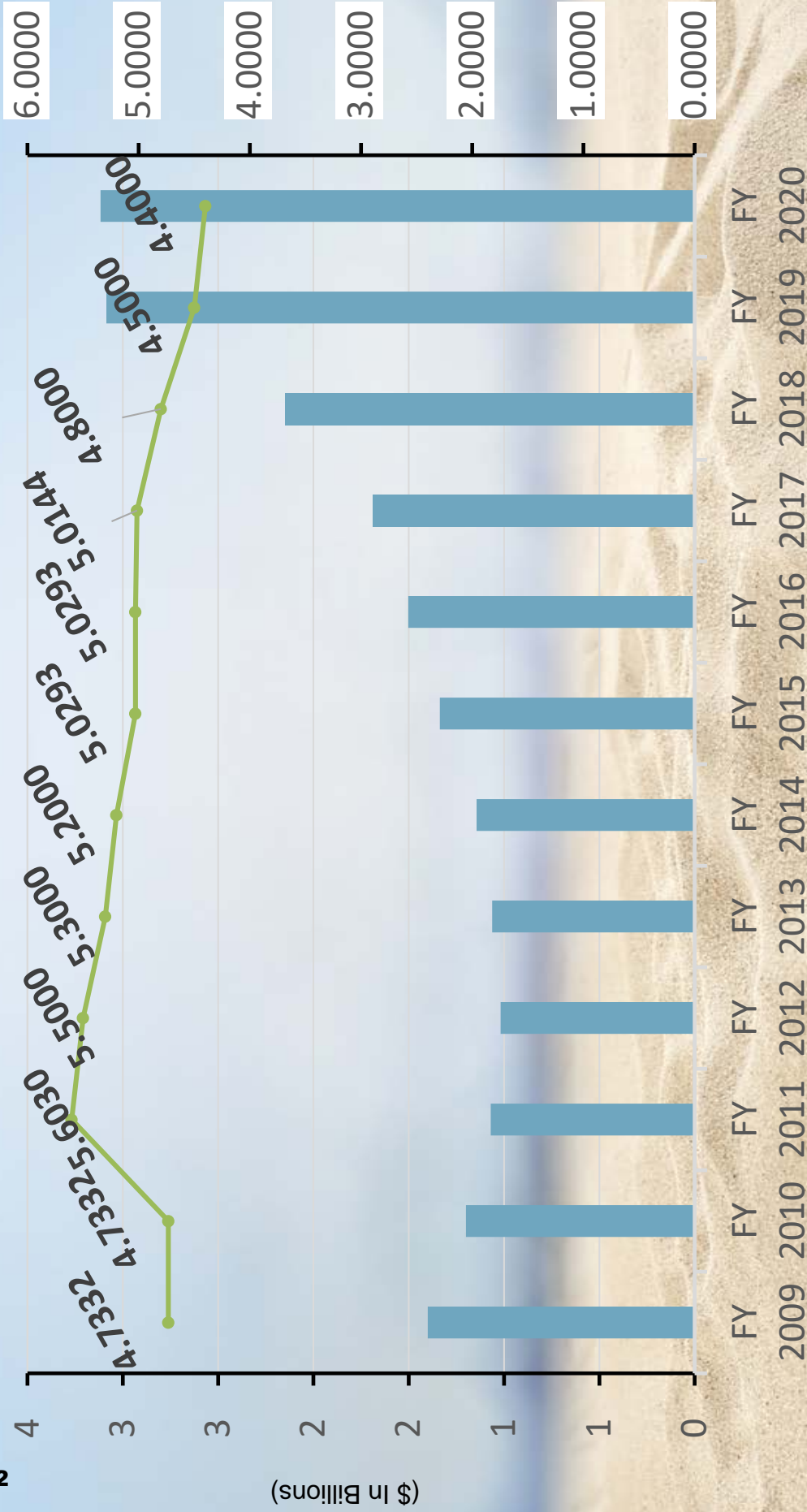

HOW MUCH OF YOUR TAX BILL GOES TO THE TOWN?

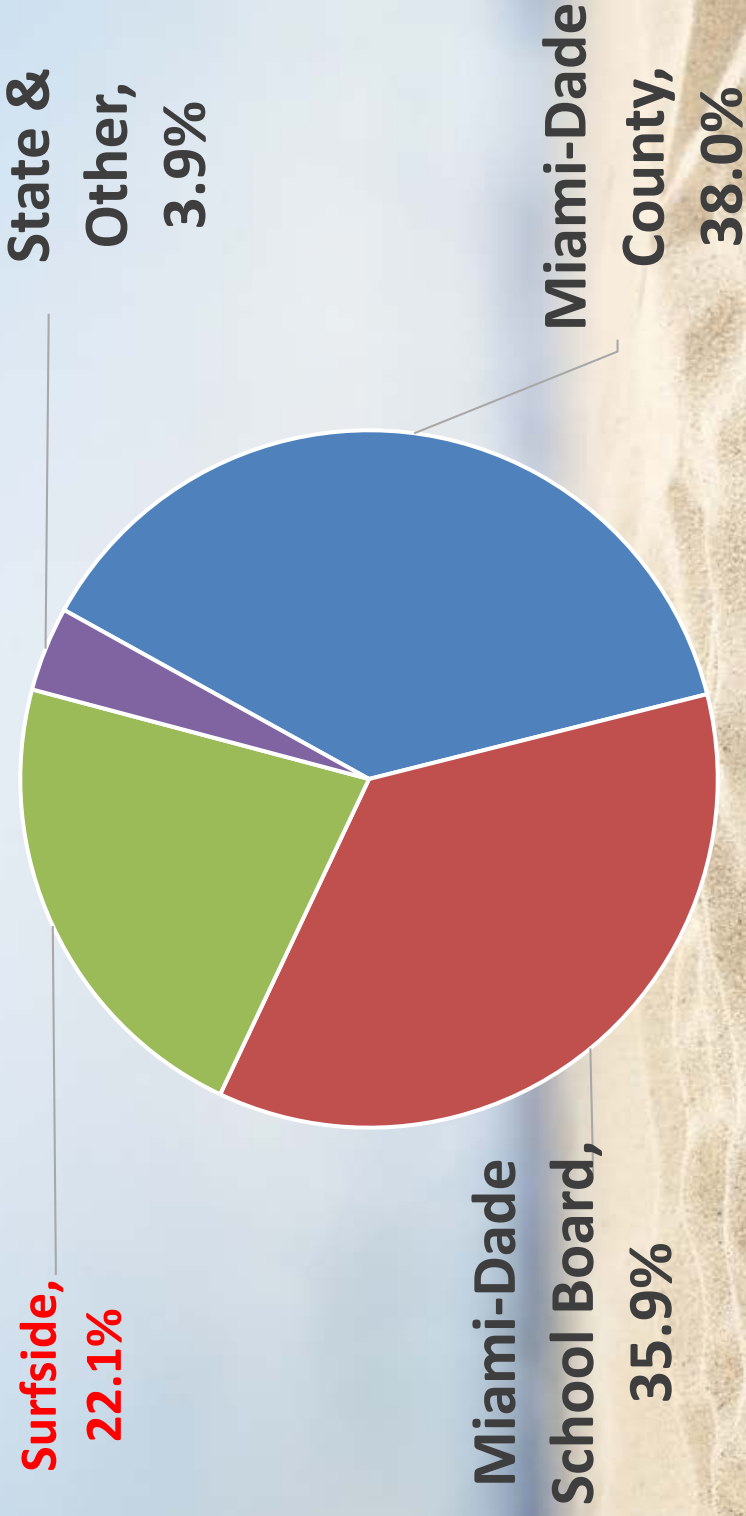

77.9% of Surfside property taxes go to other entities

Property Tax Distribution

2019 Millage Rates

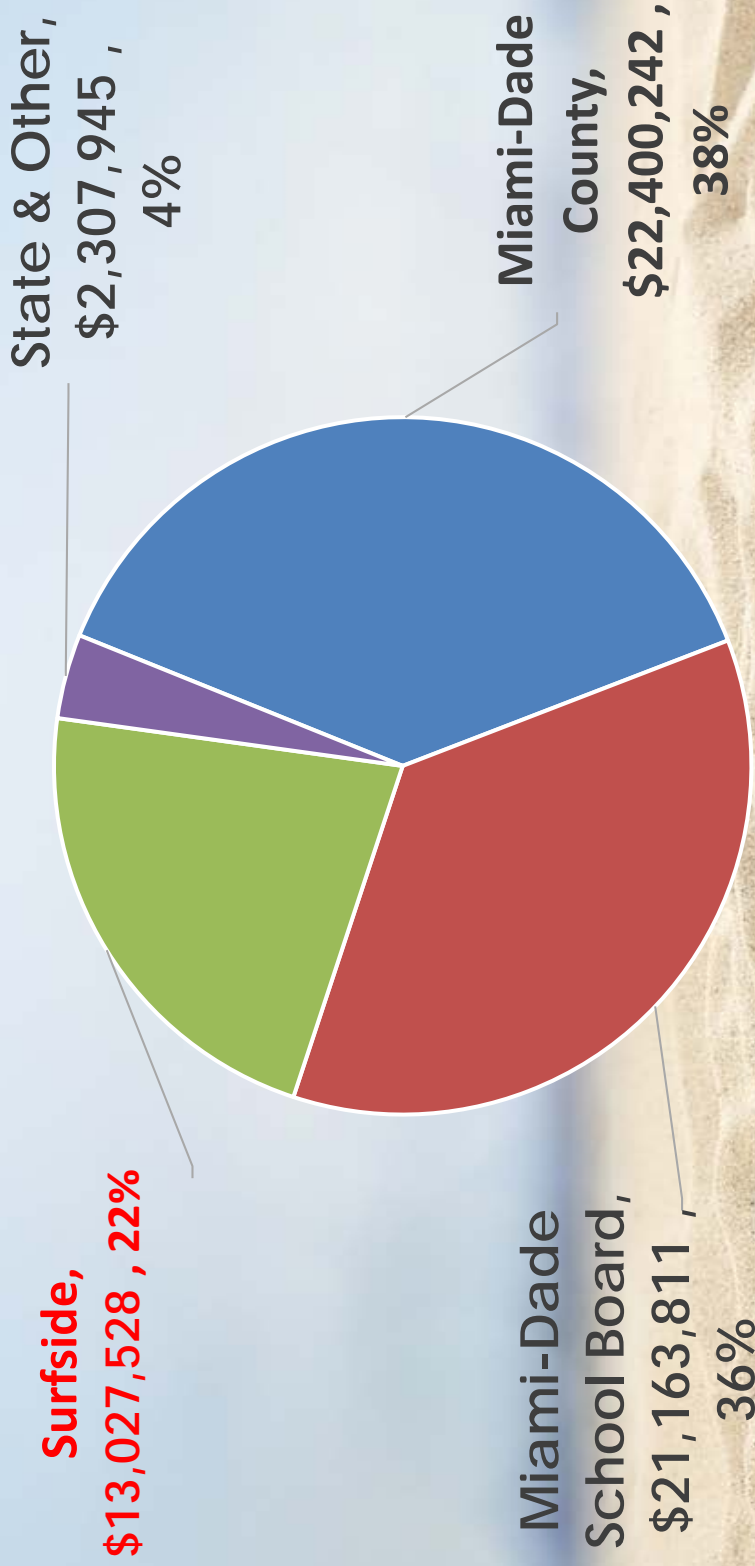

\$45.9M of the \$58.9M in Surfside property taxes go to other entities

Property Taxes Millage Rates

Fiscal Year Surfside County Miami-Dade School Board

2009 4.7332 5.1229 7.7970

2010 4.7332 5.1229 7.9950

2011 5.6030 5.8725 8.2490

2012 5.5000 5.0900 8.0050

2013 5.3000 4.9885 7.9980

2014 5.2000 5.1255 7.9770

2015 5.0293 5.1169 7.9740

2016 5.0293 5.1169 7.6120

2017 5.0144 5.0669 7.3220

2018 4.8000 5.0669 6.9940

2019 4.5000 5.1313 6.7330

2020 4.4000 5.1449 7.1480

Fiscal Year 2020 General Fund Revenues & Expenditures

\$16.5M Projected Revenues

78.7% Ad Valorem

9.0% Franchise / Utility
6.7% Intergov/ Charges for Services
5.6% Other



44.2% Public Safety

36.9% General Government

10.4% Physical Environment
8.5% Other

\$14.4M Projected Expenditures

\$2.1M added to General Fund Reserves

Revenues Forecast General Fund

\$16.5 Million

- Ad Valorem \$13.0 Million
- Franchise/Utility \$1.5 Million
- Intergovernmental \$637,500
- Interfund \$539,000
- Charges for Services \$478,700
- Other \$376,500

FY 2020 General Fund Revenues

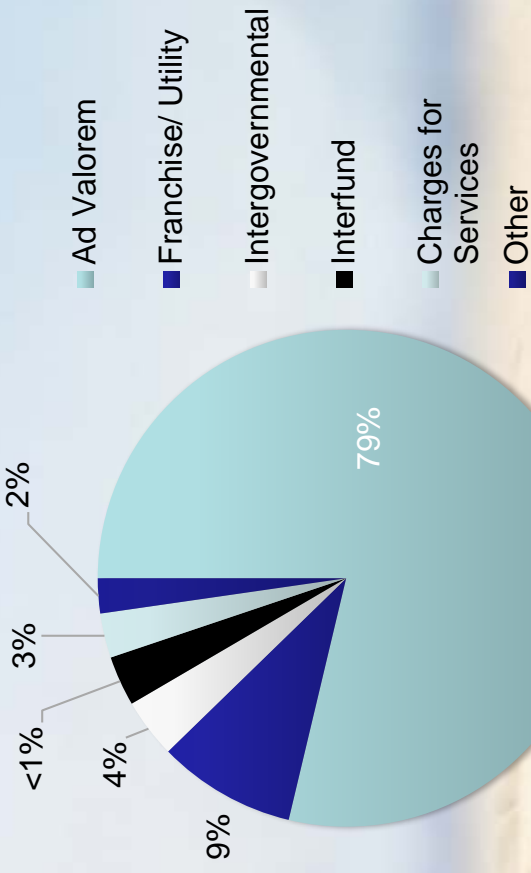

General Fund Expenditures

\$14.4 Million

FY 2020 General Fund Expenditures

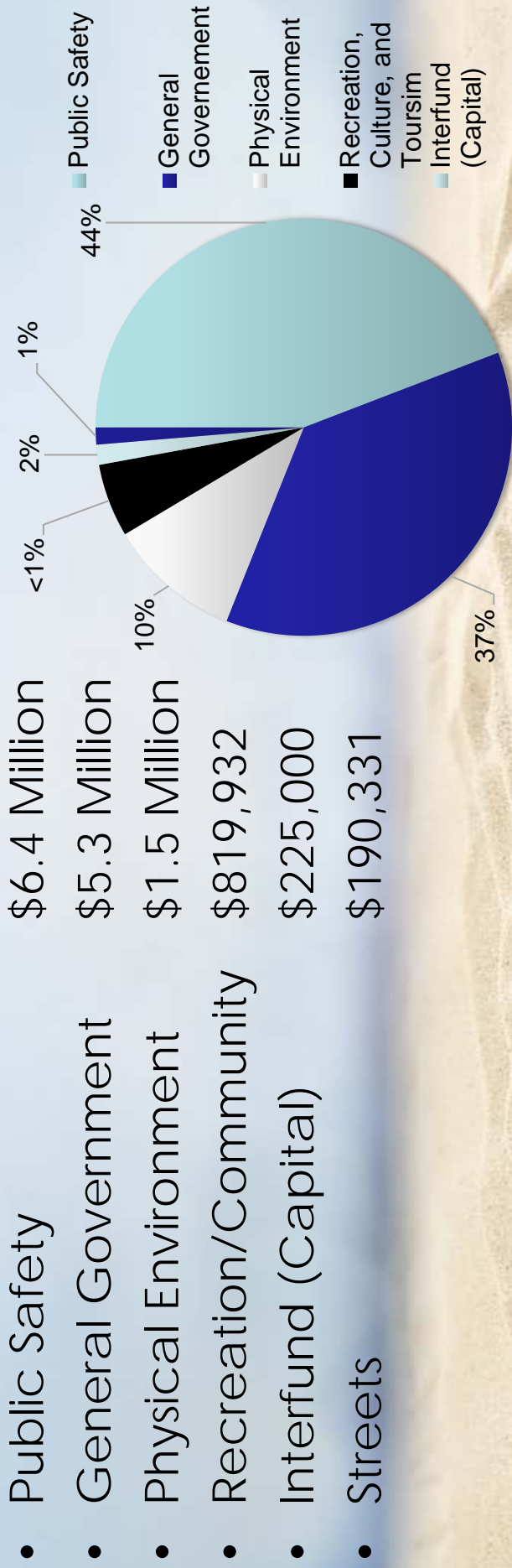

Enterprise Funds – Water & Sewer

- The Town operates its Water and Sewer System and funds the operations, maintenance, administration, debt service, and infrastructure renewal and replacement needs through user fees and available reserves.
- The Town has issued bonds to pay for a portion of its water and sewer capital project and the debt service is repaid through the system's net revenues.
- Town water is purchased from Miami-Dade County at wholesale rates and transmitted through Town owned water lines.
- Wastewater (sewer) runs through the Town's collection system and is discharged under an agreement with the City of Miami Beach.
- The Water and Sewer division also performs functions related to billing and collection for the services provided.
- General Town administrative support provides services for Water and Sewer operations such as: oversight, finance, payroll, human resources, benefits and pension management, and the provision of office space.

Fiscal Year 2020 Water & Sewer Fund Revenues & Expenditures



*81% of the Operating Costs are direct past throughs
 *75% of the all expenses are debt service and pass throughs

\$340,000 added to Reserves – FY 19 FY end balance = **(\$1.4M)**

Enterprise Funds – Parking

● Page 341

- The Town operates its own municipal parking enterprise fund. The Town currently operates several parking lots and on-street parking spaces to provide parking throughout Town and convenient access to the Harding Avenue business district.
- Municipal Parking operations are under the supervision of the Public Safety Department.
- The Town provides these services with Parking Division in-house staff and contracts with a private company for collection from parking meters.
- Parking citation revenue is allocated to the General Fund.
- General Town administrative support provides services for Municipal Parking operations such as: oversight, finance, payroll, human resources, benefits and pension management, and the provision of office space.

Fiscal Year 2020 Parking Fund Revenues & Expenditures

\$1.3M Projected Revenues

82% Metered Fees
12% Permit Fees and Other
6% Fund Balance



45% Operating Costs

44% Personnel Costs

11% Other Costs

\$1.3M Projected Expenditures

\$76,000 reduction in Reserves – FY 19 FY end balance = \$1.2M

Enterprise Funds – Solid Waste

● Page 343

- The Solid Waste Fund accounts for the cost of operating and maintaining collection and disposal services for Town residents and commercial businesses/properties.
- Solid waste collection and disposal services are provided by the Town for garbage, bulk trash, and vegetation.
- The Town provides in-house collection and disposal of recyclable materials for residential properties.
- Solid waste collection charges for residential property are billed by Miami- Dade County on the real property tax notice as a non-ad valorem assessment. The residential property assessment of \$318.67 for garbage/recycle is assessed for FY 2020. Variable rates are charged for multi-family units and commercial properties. The Town is in the process of evaluating commercial rates.
- General Town administrative support provides services for Solid Waste operations such as: oversight, finance, payroll, human resources, benefits and pension management, and the provision of office space.

Fiscal Year 2020 Solid Waste Fund Revenues & Expenditures

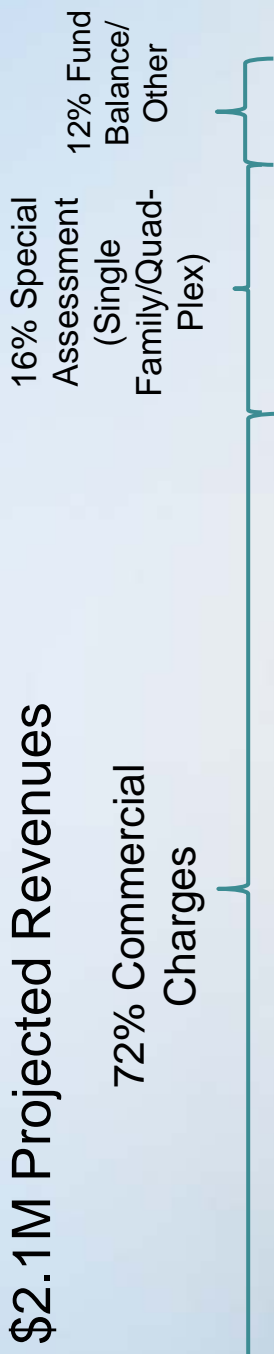

*57% of Operating Costs are tipping-type fees

\$2.1M Projected Expenditures

\$222,000 reduction in Reserves – FY 19 FY end balance = \$655,000

Enterprise Funds – Stormwater

- The Stormwater Utility Fund accounts for the cost of operating and maintaining the Town's stormwater drainage system in accordance with the Environmental Protection Agency National Pollutant Discharge Elimination System (NPDES) permit.
- The Town is in the process of developing a Stormwater Master Plan which should be updated at 5 year to properly document new projects and to adapt with future conditions. (On Hold)
- The Town contracts out many of the stormwater related functions.
 - Include planning, developing, testing, maintaining, and improving the management of waters resulting from storm events.
 - Vacuum truck services as well as a street sweeping program to maintain the stormwater infrastructure are funded.
- General Town administrative support provides services for stormwater operations such as: oversight, finance, payroll, human resources, benefits and pension management, and the provision of office space.

Fiscal Year 2020 Stormwater Fund Revenues & Expenditures



\$166,000 reduction in Reserves – FY 19 FY end balance = \$3.2M

Contact Info

Page 347

- Website: <https://townofsursidefl.gov/departments-services/finance>
- Jason D. Greene, CGFO, CFE, CPFIM, CICA
jgreene@townofsursidefl.gov





MEMORANDUM

ITEM NO. 4DD

To: Honorable Mayor, Vice-Mayor and Members of the Town Commission
From: Guillermo Olmedillo, Town Manager
Date: May 26, 2020
Subject: Calvin Giordano Contracts

At the May 12, 2020 Commission Meeting, the Commission has requested a report on the Calvin Giordano contracts laying out the options and a recommendation for each service area. At the May 14, 2020 Special Commission meeting on Planning & Zoning, the Commission provided direction to both prepare RFQ for Planning department services as soon as possible and advertise a new in-house planner.

General Engineering Consultant (GEC) Services

- Option #1 – Re-procure services now
 - Prepare RFQ as soon as possible for Architecture, Engineering and Surveying Services per Consultants' Competitive Negotiation Act (CCNA), section 287.055, Florida Statutes
 - Select a pool of engineering firms that will be pre-qualified
 - CGA to remain until such time as a vendor(s) are under contract and transition complete
- Option #2 - Complete CGA contract term ending September 30, 2021
 - Begin re-procurement later in year so as to be ready for possible transition to a new vendor(s)
- Option #3 – Build new In-house Engineering Department
 - Develop cost for an inhouse Engineering Department
 - CGA to remain until such time as new staff are hired and transition complete

Information Technology

- Option #1 – No change
 - Continue with services as provided
- Option #2 – Bring Multi-media Specialist in-house
 - Develop cost for an in-house Multi-media specialist
 - CGA services to remain until such time as new staff are hired and transition complete
- Option #3 – Build new In-house Information Technology Department (all staff)
 - Develop cost for an in-house Information Technology Department
 - CGA to remain until such time as new staff are hired and transition complete
- Option #4 – Re-procure services now
 - Prepare RFQ as soon as possible for Information Technology consultants
 - CGA to remain until such time as a vendor is under contract and transition complete

The Administration recommends option #1 for GEC services and Information Technology.

Reviewed by: GO/LA

Prepared by: JDG

IT Services Contract – CGA number 17-9175

Monthly Fee: \$11,031.31

Potential Additional Fees: \$238.29 per broadcasting event – including setup, AV during meeting, posting after the meeting is over. Average Commission Meetings are 4 hours (30 min setup, 3-hour meeting, 30 min broadcasting of video)

After hours or weekend services (Police Department Emergencies/ Downtime to background check servers) \$101.34/hour only at Town request.

Staff assigned to contract: Jose Feliz, Support Specialist Full Time dedicated to the Town of Surfside
Eric Wells, Network Administrator Part Time dedicated to the Town of Surfside- as needed oversight, assistance and PTO coverage.

Adrian Santaella, Media Specialist Part Time (contract states 15.5 hours per month) dedicated to the Town of Surfside as needed for website updates.

Monthly Fee hours dedicated per month:

170 hours

Monthly Fee Brief scope of work:

Desktop support for all Town Staff including the Police Department, including:

- Maintain and trouble shoot all servers, computers, software, printers, scanners, phone systems at all locations
- Specifying, purchasing and setup of all new IT equipment for staff and PD
- Maintaining uptime on servers, Police Department USA Software and FDLE
- Troubleshooting Tyler ERP Software
- Upgrading Town equipment as needed, including Data Center, Data Domain, Backup Systems and Servers
- Specifying, procuring and managing installation of security systems including door strikers, locks and cameras
- Recording and Broadcasting all Public Meetings
- Closed Caption for Channel 663 and Video Streaming
- Hosting the Town Website, ensuring Website ADA Compliance and up to 20 hours of Website posts and updates
- Parks & Recreation RecTrac software upgrade implementation
- Managing NetMotion and AT&T to integrate GPS on all Town equipment such as Laptops as a theft deterrent/tracking system.
- Managing Surveillance Cameras for PD, Town Hall, Abbott Lot, 96th Park and Community Center.
- Keeping SCALA up to date (Town Broadcasting)

Calendar year 2019 costs: \$272,688

Planning & Zoning Contract – CGA number 07-1539 Surfside Planning & Zoning & 07-1536 Community Development Director

Monthly Fee: \$6,695.34 (P&Z) & \$8,990.87 (Community Development) - Total \$15,686.21

Potential Additional Fees: Cost Recovery:

Large development projects may result in additional fees which are paid as a cost recovery fee, which is paid by the developer and not from the Town's funds.

Other additional Planning & Services not contained in Monthly Fee:

Planning & Zoning Extra - Billed per hour on as needed basis and authorized at up to \$15,500 for FY 2020:

Renderings requested by Town Administration or the Planning and Zoning Board performed by Urban Designers.

Resiliency Planning & Meeting attendance - Billed per hour on as needed basis and authorized at up to \$6,818.62 for FY 2020:

As requested, attendance at Resiliency-type meetings

Staff assigned to contract:

Sarah Sinatra Gould, AICP, Director of Planning Services, largely working for the Town of Surfside. Coordinates studies and graphics relating to requests by the Planning and Zoning Board. Answers calls and emails from the public. Performs cursory reviews of applications for the public prior to submittal for Planning and Zoning. Performs code updates as requested by the Planning and Zoning Board and/or Town Commission.

James Hickey, AICP, Planning Administrator, Part time dedicated to the Town- provides assistance and coverage for Sarah Sinatra Gould to ensure complete continuity through PTO or other absences. Reviews applications and provides feedback to the public.

Daniel Mantell, Planner, Part time dedicated to the Town - reviews residential and sign applications, responds to emails from residents, staff and developers.

Joanne Maglietta, Zoning Tech, part time dedicated to the Town- responds to phone calls and emails. Answers general zoning questions. Provides responses to zoning confirmation letters.

Casey Ogden, GIS Specialist, Part time dedicated to the Town – provides GIS graphics and produces maps relating to distance separation of uses as requested by the Planning and Zoning Board.

Monthly Fee hours dedicated per month:

150 hours

Monthly Fee Brief scope of work:

Complete management of the Planning & Zoning Department:

- Prepare reports, data, analysis, graphics and other assignments requested by the Planning and Zoning Board
- Prepare presentations and present staff reports for public hearings, including Commission Meetings
- Attend Staff meetings, Town Commission meetings, Development Review meetings and Planning and Zoning Board meetings
- Act as liaison between Town, South Florida Regional Planning Council and State Department of Economic Opportunity and such other local, state and federal agencies as may interact with Surfside for the various programs within the Planning Department
- Attend County and State agency meetings and forums as required
- Answer calls and emails from the public relating to zoning questions
- Answer calls and emails from Mayor, Vice Mayor, Commissioners and Town Staff
- Provide cursory reviews of plans to residents prior to submitting for planning and zoning or permits
- Review and administer zoning permits
- Review development applications through cost recovery
- Interact as needed with Town Staff including permit review with the Town Building Department

Calendar year 2019 costs: \$248,416

Engineering Services Contract – CGA number 07-1541

Monthly Fee: \$7,669.40

Potential Additional Fees: Special projects/tasks such as 10-year water supply, Stormwater Master Plan, etc. with costs based on hourly rates. Proposals are submitted to Town Staff for review then presentation to Commission, as required, for discussion and approval or rejection.

Other additional Engineering Services not contained in Monthly Fee:

Water & Sewer Support - Billed per hour on as needed basis and authorized at up to \$24,900 for FY 2020:

Hourly Town Staff supplemental support including, but not limited to Engineering assistance for atlas upgrades, printing, electronic updates, etc., leaks, breaks, pump station trouble shooting, repairs, and operational assistance, calls and email responses in the event of a loss of service to either water or sewer system, initial project review and discussion. Constructability questions and reviews for any Town Staff inquiries/in-house projects. Any portion of the PO that is not utilized is not billed to the Town.

Stormwater/NPDES Support - Billed per hour on as needed basis and authorized at up to \$6,000 for FY 2020:

Hourly Town Staff supplemental support to include Engineering assistance for as-builts/atlas updates, NPDES monitoring and reporting, drainage pump station troubleshooting, repairs and maintenance and operational assistance. Constructability questions and reviews for any Town Staff inquiries/in-house projects. Any portion of the PO that is not utilized is not billed to the Town.

Staff assigned to contract: Nicholas Kanelidis, PE Project Manager - a portion of everyday dedicated to the Town of Surfside

James Hart, PE, Project Manager – Part time dedicated to the Town – review of pump station controls and data for Sewage and Drainage Stations

Jenna Martinetti, PE Director of Engineering – Part Time dedicated to the Town- oversight of staff and assistance as needed

Bob McSweeney, PE, Director of Construction – Part time dedicated to the Town – construction related questions, constructability reviews and review comments for any outside or in-house projects.

Chris Giordano, MSC, CCM, Vice President – Part Time dedicated to the Town- client contact, oversight and assistance as needed

Monthly Fee hours dedicated per month:

60 hours

Monthly Fee Brief scope of work:

Staff and manage the Town's Engineering Department as required to complete the following tasks:

- Phone calls, emails, presentation preparation and meetings as needed with Staff, Boards and Commission regarding engineering or Public Works related items, questions and concerns
- Daily monitoring of the Town's five (5) pump stations: alarm review, run time review, number of starts, instrumentation functioning check
- Monthly and quarterly meetings (Utility Round Table) with the County to ensure compliance of all required regulations and reporting – complete County required reporting
- Annual GIS reporting to the County for water, sewer, and drainage infrastructure
- Sewage Transmission and Disposal Duties
 - Documentation/Reporting required by Consent Decree
 - Documentation/Reporting required by Consent Agreement
 - NAPOT Report Review
 - Analysis and Graphing of Sewage Flow vs Rainfall
 - Inflow Infiltration Analysis
 - Billing Review from County
 - Annual CMOM reporting to the County
 - Annual SSES reporting to the County
- Water Distribution and Consumption Duties
 - Billing Review from the City
 - Lead and Copper Reporting and Compliance
 - Monthly water accounting to determine water sold versus water loss
 - Monthly bacteriological test reporting for the County
- Project Feasibility/Analysis
 - Participate in discussions with Staff, Residents and Commission regarding any potential projects
 - Provide input/cost analysis for potential projects
 - Present to Commission on potential projects and estimated costs/benefits
- Minor grant writing assistance
 - Technical write-up
 - Exhibits
 - Potential Project Cost Estimates

Calendar year 2019 costs: \$273,127

**For additional information on calendar year 2019 tasks including projects see attached supplemental*

CGA Payments by contract/tasks for Calendar Year 2019

	<u>CY 2019</u>		
	Paid		
Information Technology			
General Services			
Monthly IT retainer	130,290	48%	
Extra Services			
After hours extra time	16,646	6%	
Broadcasting support	10,553	4%	
Projects			
ERP Implementation Support	115,200	42%	
	<u>272,688</u>	<u>100%</u>	34%
Planning & Zoning/Community Development			
General Services			
Community Development Director Services - Monthly retainer	106,135	43%	
Planning and Zoning – Monthly retainer	78,589	32%	
Extra Services			
Planning & Zoning extra hrs. outside of monthly retainer	11,539	5%	
Cost Recovery (part of Planning Contract)	22,032	9%	
Projects			
Resiliency Planning (Climate Change Action Report)	30,122	12%	
	<u>248,416</u>	<u>100%</u>	31%
Engineering/PW			
General Services			
General Engineering Services – Monthly Retainer	90,547	33%	
Extra Services			
General Public Works extra hours outside of monthly retainer	87,153	32%	
Water & Sewer Support Services	36,782	13%	
GIS Water/Sewer	160	0%	
Projects			
Downtown Street Lighting Support	412	0%	
Stormwater Master Plan	4,731	2%	
Solar Panel Engineering Support	14,596	5%	
96th Street Park RFP Support	6,014	2%	
96th Street Park Survey	3,735	1%	
Traffic signal mods at 88, 93, and 94 St - bidding assist., CEI, closeout	8,687	3%	
Town of Surfside Street Light Inventory	2,263	1%	
Surfside Community Center Indoor Air Quality testing	1,170	0%	
Town of Surfside Dune Survey & Beach Management Plan	8,478	3%	
Surfside Parking Utilization Study - Data Collection	8,400	3%	
	<u>273,127</u>	<u>100%</u>	34%
	<u>Totals:</u>	<u>794,232</u>	



**Town of Surfside
Town Commission Meeting**

Town Hall Commission Chambers - 9293 Harding Ave, 2nd Floor
Surfside, FL 33154

DISCUSSION ITEM MEMORANDUM

Agenda #:

Date: April 24, 2020

From: Vice Mayor Tina Paul

Subject: Undergrounding power lines

Report – April 6, 2020 Conversation with Christopher Ferreira, FPL External Affairs Advisor

Florida Public Service Commission is finalizing rules; FPL will put together a plan for review.

The Resiliency Act – Lateral Lines will be placed underground (FPL lines only)

20 or 30-year plan to be built into rates, Plan will begin next year, in 3 year cycles, sporadic, not the whole town. Performance of lines will determine how to move forward.

Feeder lines are hardened, Lateral lines go underground.

Hardening will produce more efficient restoration times. Transformer and Insulation strengthening.

Wind load determines if poles are concrete or wood for main arterial lines.

Underground Premium Service – customers or city, requires a ballpark estimate that can go up or down, based on deep engineering.

A joint use agreement is needed between FPL, AT&T and Atlantic Broadband.

Currently Sunny Isles is the only municipality with a plan for Undergrounding. Key Biscayne has not moved forward.

Recommendation – Look at Cost Benefit Ratio.

FPL Undergrounding

Guillermo Olmedillo <golmedillo@townofsursidefl.gov>

Mon 4/8/2019 5:01 PM

To: **Elected Officials** <ElectedOfficials@townofsursidefl.gov>

Mayor, Vice Mayor and Commissioners:

In order to keep you informed, the message below explains the latest position by FPL in reference to undergrounding utilities.

Should you have questions, please advise.

Thank you



Guillermo Olmedillo

Town Manager

Town of Surfside

9293 Harding Ave

Surfside, FL 33154

(305) 861-4863 (305) 993-5097 F

Email: golmedillo@townofsursidefl.gov

www.townofsursidefl.gov

P Please consider the environment before printing this e-mail



Guillermo,

I spoke to John Lehr and Aletha Player of FPL on Friday afternoon, and I think I have some information of substance to share with you.

Easements/ROW agreement

With respect to the need for easements beyond the existing R-O-W: easements beyond the R-O-W limits are NOT REQUIRED as a matter of policy. In lieu of that, FPL is willing to accept a R-O-W agreement with the TOWN to memorialize an agreement between the two parties that should the Town or any other agency require FPL to relocate, adjust, or rearrange any of their underground facilities, the Town (or other agency) will provide FPL with an alternative location for the facilities and will pay any costs associated with the relocation, adjustment, or rearrangement, AND the Town (or other Agency) shall also reimburse FPL for any

costs to locate, expose, or protect, or support their facilities, in the event of future construction or excavation in close proximity to the FPL facilities.

The need for easements beyond the R-O-W limits may be dictated by the availability of space for FPL's (and cable TV and telephone) within the ROW vis-à-vis other underground utilities, and the physical space available for FPL's transformers and switch cabinets.

Easement sizes

FPL's standard easement sizes are: 10' x 10' for their residential transformers (4'-0" x 4'-6" pad) and 24' x 24' for their switch cabinets (largest pad = 84" x 84", Vista u/g vault = 79" x 72"). The transformer easements are probably the minimum size they can be. However, John and Aletha have indicated that they will work with us to minimize easement sizes as merited. So, the smallest easement we may be able to provide for the Vista cabinets is 13' x 18'.

Moving Forward

If the Town is interested in moving forward with FPL, and if you are interested in pursuing the avenue that avoids the need for easements beyond the R-O-W's from each homeowner, then we need to provide to FPL:

1. The Engineering Deposit of \$60,432, as previously outlined in our white paper, and
2. As-built records of the existing underground utilities.

It's worth noting that FPL previously completed their design of this system in 2012 or 2013. I believe CGA provided them with as-builts of the underground utilities existing at that time. So, we should be able to locate their drawings and the utility as-builts from that project. We will have to re-obtain current utility as-builts, in case anything has changed, including the infrastructure work we completed with the Town at that time.

John Lehr recalls that FPL's previous design located as many of the transformers and switch cabinets as possible on Town property, thereby simplifying any easement acquisition efforts. We expect they will replicate this consideration in their updated design.

Please call me if you wish to discuss further.

Thank you,

Curt Keyser, P.E.

Director of Engineering | Engineering (Broward)



Calvin, Giordano & Associates, Inc. | [1800 Eller Drive | Suite 600 | Fort Lauderdale, FL 33316](#)

Office: 954.921.7781 | Direct: 954.766.2752 | Fax: 954.921.8807

Fort Lauderdale | Miami-Dade | West Palm Beach | Clearwater/Tampa | Estero | Port St. Lucie

Online Sunshine Logo Official Internet Site of the Florida Legislature

September 17, 2019

Search Statutes: 2019 Search

Text: 'NEW Advanced Legislative Search'

Select Year: 2019 Go

Home

Senate

House

Citorator

Statutes, Constitution, & Laws of Florida

- [Florida Statutes](#)
- [Search Statutes](#)
- [Search Tips](#)
- [Florida Constitution](#)
- [Laws of Florida](#)

Legislative & Executive Branch Lobbyists

Information Center

Joint Legislative Committees & Other Entities

Historical Committees

Florida Government Efficiency Task Force

Legislative Employment

Legistore

Links

Navigation design spacer

Interpreter Services for the Deaf and Hard of Hearing

Go to MyFlorida House

The 2019 Florida Statutes

Title XXVII

RAILROADS AND OTHER REGULATED UTILITIES

Chapter 366

PUBLIC UTILITIES

View Entire Chapter

366.96 Storm protection plan cost recovery.—

(1) The Legislature finds that:

(a) During extreme weather conditions, high winds can cause vegetation and debris to blow into and damage electrical transmission and distribution facilities, resulting in power outages.

(b) A majority of the power outages that occur during extreme weather conditions in the state are caused by vegetation blown by the wind.

(c) It is in the state's interest to strengthen electric utility infrastructure to withstand extreme weather conditions by promoting the overhead hardening of electrical transmission and distribution facilities, the undergrounding of certain electrical distribution lines, and vegetation management.

(d) Protecting and strengthening transmission and distribution electric utility infrastructure from extreme weather conditions can effectively reduce restoration costs and outage times to customers and improve overall service reliability for customers.

(e) It is in the state's interest for each utility to mitigate restoration costs and outage times to utility customers when developing transmission and distribution storm protection plans.

(f) All customers benefit from the reduced costs of storm restoration.

(2) As used in this section, the term:

(a) "Public utility" or "utility" has the same meaning as set forth in s. 366.02(1), except that it does not include a gas utility.

(b) "Transmission and distribution storm protection plan" or "plan" means a plan for the overhead hardening and increased resilience of electric transmission and distribution facilities, undergrounding of electric distribution facilities, and vegetation management.

(c) "Transmission and distribution storm protection plan costs" means the reasonable and prudent costs to implement an approved transmission and distribution storm protection plan.

(d) "Vegetation management" means the actions a public utility takes to prevent or curtail vegetation from interfering with public utility infrastructure. The term includes, but is not limited to, the mowing of vegetation, application of herbicides, tree trimming, and removal of trees or brush near and around electric transmission and distribution facilities.

(3) Each public utility shall file, pursuant to commission rule, a transmission and distribution storm protection plan that covers the immediate 10-year planning period. Each plan must explain the systematic approach the utility will follow to achieve the objectives of reducing restoration costs and outage times associated with extreme weather events and enhancing reliability. The commission shall adopt rules to specify the elements that must be included in a utility's filing for review of transmission and distribution storm protection plans.

(4) In its review of each transmission and distribution storm protection plan filed pursuant to this section, the commission shall consider:

(a) The extent to which the plan is expected to reduce restoration costs and outage times associated with extreme weather events and enhance reliability, including whether the plan prioritizes areas of lower reliability performance.

(b) The extent to which storm protection of transmission and distribution infrastructure is feasible, reasonable, or practical in certain areas of the utility's service territory, including, but not limited to, flood zones and rural areas.

- (c) The estimated costs and benefits to the utility and its customers of making the improvements proposed in the plan.
- (d) The estimated annual rate impact resulting from implementation of the plan during the first 3 years addressed in the plan.
- (5) No later than 180 days after a utility files a transmission and distribution storm protection plan that contains all of the elements required by commission rule, the commission shall determine whether it is in the public interest to approve, approve with modification, or deny the plan.
- (6) At least every 3 years after approval of a utility's transmission and distribution storm protection plan, the utility must file for commission review an updated transmission and distribution storm protection plan that addresses each element specified by commission rule. The commission shall approve, modify, or deny each updated plan pursuant to the criteria used to review the initial plan.
- (7) After a utility's transmission and distribution storm protection plan has been approved, proceeding with actions to implement the plan shall not constitute or be evidence of imprudence. The commission shall conduct an annual proceeding to determine the utility's prudently incurred transmission and distribution storm protection plan costs and allow the utility to recover such costs through a charge separate and apart from its base rates, to be referred to as the storm protection plan cost recovery clause. If the commission determines that costs were prudently incurred, those costs will not be subject to disallowance or further prudence review except for fraud, perjury, or intentional withholding of key information by the public utility.
- (8) The annual transmission and distribution storm protection plan costs may not include costs recovered through the public utility's base rates and must be allocated to customer classes pursuant to the rate design most recently approved by the commission.
- (9) If a capital expenditure is recoverable as a transmission and distribution storm protection plan cost, the public utility may recover the annual depreciation on the cost, calculated at the public utility's current approved depreciation rates, and a return on the undepreciated balance of the costs calculated at the public utility's weighted average cost of capital using the last approved return on equity.
- (10) Beginning December 1 of the year after the first full year of implementation of a transmission and distribution storm protection plan and annually thereafter, the commission shall submit to the Governor, the President of the Senate, and the Speaker of the House of Representatives a report on the status of utilities' storm protection activities. The report shall include, but is not limited to, identification of all storm protection activities completed or planned for completion, the actual costs and rate impacts associated with completed activities as compared to the estimated costs and rate impacts for those activities, and the estimated costs and rate impacts associated with activities planned for completion.
- (11) The commission shall adopt rules to implement and administer this section and shall propose a rule for adoption as soon as practicable after the effective date of this act, but not later than October 31, 2019.

History.—s. 1, ch. 2019-158.

Copyright © 1995-2019 The Florida Legislature • [Privacy Statement](#) • [Contact Us](#)



May 31, 2018

Mr. Guillermo Olmedillo
Town Manager
Town of Surfside
9293 Harding Ave.
Surfside, FL 33154

**Re: Town of Surfside
Electric Facilities Conversion – Ballpark Estimate
Entire Town
WR # 8245255**

Dear Mr. Olmedillo:

FPL welcomes the opportunity to assist you in examining the feasibility of converting from overhead electric distribution facilities to an underground system at the following location:

Entire Town limits in Surfside, Florida.

As per your request, the non-binding "ballpark" estimate to complete this conversion is \$6,700,000. This estimate is provided strictly to assist you in preliminary decision making and it does not include the conversion of any existing streetlight system. It is not an offer from FPL to perform the requested conversion and should not be construed or used as such for detailed planning purposes. This represents an "order of magnitude" figure based on previous FPL experience and reflects the CIAC payment that the Town would ultimately need to make to FPL if the conversion were performed at this point in time utilizing standard underground equipment. It is our experience that conversions in developed areas are the most complex and challenging types of construction. As such, this estimate likely will not precisely represent the Town's ultimate actual cost to convert, but can assist the Town in preliminary decision-making.

FPL estimates include only estimated charges to be paid by the Town to FPL. The costs of the following items are not included with the estimate and are the responsibility of the Town / residents. These potential costs should be included in future planning of the project:

- Site restoration (sod, landscaping, pavement, sidewalks, etc)
- Rearrangement of customer electric service entrances (requires electrician) from overhead to underground. Also, additional customer expense if local inspecting authorities require customer wiring to be brought to current codes.
- Trenching/backfilling for service laterals.
- Removal and undergrounding of other utilities (e.g. telecom, CATV, etc.)
- Acquiring, describing, securing and recording of easements for underground facilities. In underground systems, major components formerly attached to poles must now occupy "at grade" appurtenances, e.g., ground level pad mounted transformers and switch cabinets. Facilities of an underground distribution system will not be placed in road right-of-way, with the exception of cables required for crossings. (See special note below)

Note: Obtaining easements is typically the most difficult aspect of the conversion process; the time required to secure the easements may even exceed the 180 day binding estimate timeframe. FPL strongly suggests that all easements required for the conversion be described and secured prior to requesting the detailed cost estimate.

In 2007, the Public Service Commission approved FPL's 25% Governmental Adjustment Factor (G.A.F.) waiver for local government sponsored projects. In order to be eligible for the G.A.F. waiver a project must meet a series of criteria (see Attachment). Based on the preliminary information you provided for the proposed conversion area, this request would qualify for the G.A.F. waiver. The G.A.F. waiver amount is not reflected in the ballpark estimate presented above.

After reviewing the "ballpark" estimate, if you decide to move forward with the conversion project, you may request a detailed and "binding" estimate. Due to the complexity and time required to estimate such a conversion, a non-refundable engineering deposit is required prior to beginning the estimating process, as set forth in the Florida Administrative Code 25-6.115. For this conversion project the amount of the required engineering deposit is \$60,432.00. If you decide to proceed with the work contained in the estimate, the amount of this deposit would be applied toward the estimated amount owed to FPL for the conversion. The work must commence within 180 days of the date the binding estimate is provided.

The request for the binding estimate must be in writing, and must describe in detail the facilities to be converted. Binding estimates are valid for 180 days, and would be subject to change in the event of a work scope change. Should actual FPL costs exceed the binding estimate amount, the customer may be responsible for those additional costs up to a maximum of 10% of the binding estimate amount. Payment of customer costs, easements (with opinion of title and recorded), agreements from other utilities/pole licensees, and execution of a Conversion Agreement would be required before commencement of construction.

If you have any questions or wish to consider a binding cost estimate, please call me at 305-442-5711.

Sincerely,

Jose Triana
Customer Advisor
Customer Service
Florida Power & Light Company

Attachments

cc: Mr. Tom Allain – FPL
Mr. John Lehr – FPL
Mr. Roger Mendoza – FPL

Sandra Novoa

From: Mayor
Sent: Wednesday, April 22, 2020 6:17 PM
To: Fernanda Siqueira
Subject: RE: Construction in Condos

Hi Fernanda,

Thank you for the nice note!

I think the dog park is the easier of the two requests. It seems to me with the proper safety precautions, it shouldn't be an issue. I've copied our clerk and asked that the dog park be added to the agenda for action.

On the balcony issue, I totally get your point. I can't imagine having to work, while that type of construction is going on around me. Having said that, I think the decision to work, or not work, at this time at any particular location (assuming it's done per the safety requirements) would be a decision to be made by you and your condo board. I'm not sure that we could step in and manage issues like that from the Commission. Have you tried reaching out to your condo board?

As you know, if I can be of any help with anything, I'm available.

Thanks,

Charles

Charles W. Burkett
Mayor



Town of Surfside
9293 Harding Avenue
Surfside, Florida 33154
Phone (305) 861-4863
Mobile phone: (305) 992-7965

"If you think you are too small to make an impact, try spending the night in a room with a mosquito." African proverb

-----Original Message-----

From: Fernanda Siqueira <fernandaj1@yahoo.com>
Sent: Wednesday, April 22, 2020 3:26 PM
To: Charles Burkett <charles@burkettcompanies.com>
Cc: Eliana For Commissioner Salzhauer <esalzhauer@gmail.com>; Nelly <nellyforcommissioner2020@gmail.com>; Charles Kesl <cekesl@gmail.com>
Subject: Construction in Condos

Hello Mr. Mayor and commissioners,

First of all, congratulations on “our” win! I am ver happy to have you all representing our Town now.

I’d like to voice my opinion regarding bringing construction back to the condos.

I live at the Waverly and both our buildings have been under concrete restoration, balcony repair and pool renovation for one and half year. We are next door to the Carlyle that is also working on their balconies and concrete restoration for over 2 years now. You can imagine that life here on 92nd has not been easy. The noise from the work is extremely loud, the workers park in our garages, they use our elevators and also our building bathrooms.

When they drill the balconies or outside walls, the building trembles.

I work from home, so usually just go to the library and work from there when the noise is unbearable here.

At this pandemic time, I also have my 12 year who is in 7th grade studying from home. Her school is live on Zoom from 8:30- 3:45 with a break just for lunch.

It will not be possible to stay locked in our small condos working or studying from home while men drill the outside and surround the building while we are supposed to be practicing social distancing.

There are literally hundreds of people locked here at the Waverly and as it is it’s already hard to stay safe when some residents walk around the common areas with no masks.

It is very different to allow work on the Shul or an empty single family home where there are no residents.

Please don’t allow work on the condos until it’s safer and residents have the option to go elsewhere.

On another note, would you consider opening up the dog park? My dog hasn’t been off her leash and able to run in over a month. I’m sure other condo residents have the same problem too. Our dog park has never been a place of gathering.

Thank you for your time,

Fernanda Siqueira
9172 Collins Ave. 409
786-214-1055



**Town of Surfside
Town Commission Meeting**

Town Hall Commission Chambers - 9293 Harding Ave, 2nd Floor
Surfside, FL 33154

DISCUSSION ITEM MEMORANDUM

Agenda #:

Date: April 24, 2020

From: Vice Mayor Tina Paul

Subject: FPL Solar Together Program

Objective – Enroll all Town of Surfside municipal properties in the FPL SolarTogether program.

Consideration – In March 2020, the Florida Public Service Commission approved the FPL SolarTogether program. As the largest community solar program in the United States, SolarTogether removes traditional barriers such as large upfront costs, long-term commitments and has no penalties for unsubscribing. It allows for all FPL customers to go 100% solar with no rooftop installation, maintenance or required insurance.

At the April 21, 2020 Special Commission Meeting, the Commission voted to end CGA Work Authorization No. 117, from July 2019 for Engineering Services for Design-Build Photovoltaic System at the Surfside Community Center.

Surfside has always actively pursued clean energy and environmental initiatives therefore; participating in the FPL SolarTogether program at all Town Facilities will continue these efforts while affording the Town long-term savings.

The FPL SolarTogether program is currently fully subscribed and the waitlist has also been filled.

Recommendation – Direct the Town Manager or designee to contact our Customer Advisor Jose Triana for information on enrolling in the next sign-up for FPL’s SolarTogether program.



Thank you for your interest FPL SolarTogetherSM
 The program is fully subscribed and the waitlist is closed.

The SolarTogetherSM program is an easy and affordable option for customers to share in the economic and environmental benefits of Florida based large-scale solar while receiving monthly bill credits on their FPL bill.

At this time, the Commercial, Industrial and Governmental portion of the program is fully subscribed. And, due to overwhelming interest, the waitlist has reached maximum subscription and is closed. We will continue to find new and innovative ways to bring even more solar to Florida and will announce future program opportunities.

Reduce your energy costs while achieving your sustainability goals



Benefits

- Offset up to 100 percent of your energy usage (subject to availability)
- Renewable Energy Credits (RECs) are retired on your behalf
- Receive bill credits immediately



Economics

- Simple payback between 5-7 years
- Fixed monthly subscription rate
- Escalating bill credits
- No maintenance, operational or insurance costs



Terms

- No upfront cost
- No long term contract
- Subscription is transferable to another store or location
- Subscription cannot be sold or transferred to another customer

How the program works

1. Determine your subscription share by selecting the amount of energy you wish to offset – up to 100% of your energy usage can come from solar
2. Calculate your monthly subscription cost based on the fixed subscription rate of \$6.76/kW multiplied by your subscription share
3. Estimate your monthly subscription credit based on your subscription share multiplied by the amount of solar energy produced multiplied by the subscription credit rate

100 kW subscription example

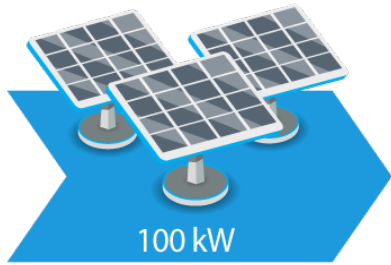

FPL SolarTogether Subscription

100 kW subscription share
x \$6.76/kW fixed subscription rate

Your Monthly Subscription Cost

\$676



Solar Energy Produced

190 hrs per month
x 100 kW subscription share

19,000 kWh solar energy



Subscription Credit

19,000 kWh solar energy produced
x \$0.03405/kWh subscription credit rate/kWh

Your Monthly Bill Credit

\$647

That means you get solar energy for just \$29 for the month!*

* Illustrative examples presented here for discussion purposes only, program charges and credits will be established per the Florida PSC approved tariff.

And over time, the annual benefits are forecasted to exceed the costs.

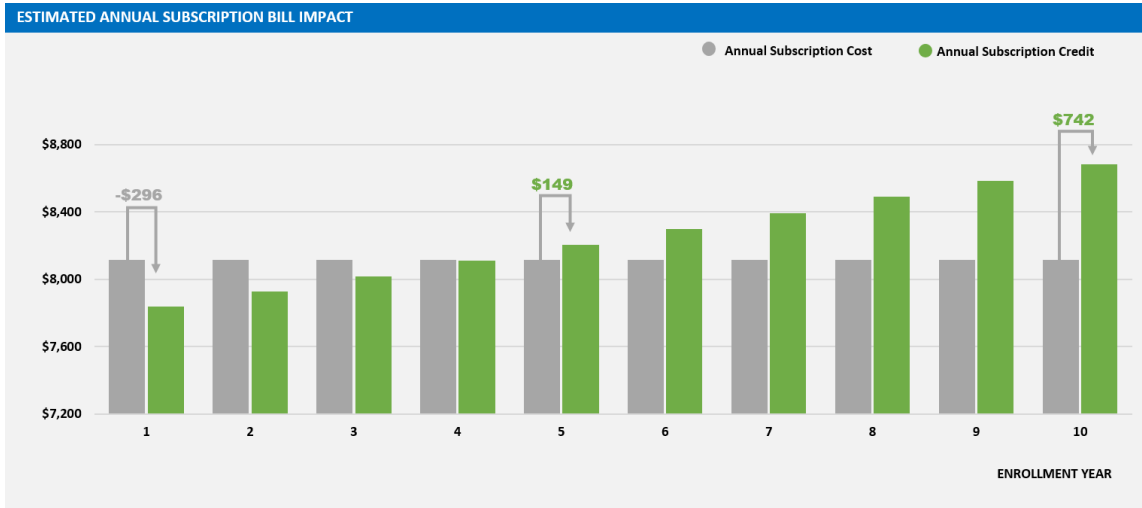

The graph above shows the estimated bill impact over a ten-year period for a 100 kW subscription example. While the annual subscription cost remains the same year after year, due to the fixed nature of the subscription rate, the annual subscription credit grows annually. In the first year of a 100 kW subscription, program participation would cost approximately \$296, which is the difference between the subscription cost of \$8,112 and the credit of \$7,816. By year five, the annual subscription remains \$8,112 and the credit grows to \$8,261, so the credit exceeds subscription cost by \$149. By year ten, the cost of the subscription is still \$8,112 and the credit is now \$8,854 for the year, increasing the credit difference by \$742.

Have Questions?

View our frequently asked questions (<https://www.fpl.com/energy-my-way/solar/solartogether-res/faq.html>).



**Town of Surfside
Town Commission Meeting**

Town Hall Commission Chambers - 9293 Harding Ave, 2nd Floor
Surfside, FL 33154

DISCUSSION ITEM MEMORANDUM

Agenda #:

Date: May 5, 2020

From: Vice Mayor Tina Paul

Subject: Climate Environmental Collective - revised

Objective – Establish a Climate Environmental Collective to deal with climate change as it relates to health, economics, new technologies, and infrastructure innovations for coastal Issues and develop communication campaigns that keep the public informed and promote a strong and healthy town.

Consideration – At the April 14, 2020 Special Town Commission meeting, a decision to abolish the Sustainability and Resiliency Committee was made by the Commission with the decision to include a Sustainability and Resiliency board member on all Town Boards and Committees. While this approach is progressive, the concern of many residents for issues facing a coastal community as a result of Climate Change remains a priority.

The question is, do we want to be progressive or become more radical in our approach?

We've witnessed the triumph of environmental activist Greta Thunberg, who has gained international recognition as a teenager promoting awareness of the reality that humanity is facing an existential crisis arising from climate change. Instead of forming a Task Force or Board or Committee, the Climate Environmental Collective will consist of individuals who work together on ideas and solutions without relying on internal hierarchies.

We can benefit from persons with experience that may include: an Environmental Engineer or Specialist, Water Researcher, Health Practitioner, Marine or Atmospheric Scientist, Oceanographer, Biologist, Economist, Information Technology or Coder, and Graphic Artist. Membership will be diverse and inclusive of residents with all levels of expertise or enthusiasm for Surfside's environment.

The Town Manager recently hired a Resiliency Officer who has been working on specific projects from the previous commission. The new Sustainability members on Town Boards and Committees will work on issues with each Board and Committee; the Climate Environmental Collective can compliment their work. Environmental issues need to be approached as a whole, to assure genuine consideration of climate change, sea-level rise, carbon footprint, renewable energy and green infrastructure strategies with an additional focus on public health. The Collective's meetings do not need paid Consultant experts, or to be televised, and only require a meeting place and minimum staff assistance. It is essential for this Collective to be recognized as an integral part of the Town.

Recommendation – Approve the Climate Environmental Collective because Climate Change and Sea Level Rise is today and if we wait, it will be too late. We are living through Covid-19 now and as a Zoonotic disease it is a direct result of Climate Change and deforestation. The actions needed to combat this pandemic are the same actions we need to confront Climate change. This issue has never been more important, adding a Collective to present ideas and solutions at a minimal cost can actually be invaluable.

RESOLUTION NO. 14 - 2251

A RESOLUTION OF THE TOWN COMMISSION OF THE TOWN OF SURFSIDE, FLORIDA, AMENDING THE FEES TO BE ASSESSED PER PARKING SPACE PROVIDED IN SECTION 90-77 OF THE TOWN CODE WHICH ESTABLISHED A TRUST FUND TO BE ENTITLED THE "TOWN OF SURFSIDE DOWNTOWN PARKING TRUST FUND; REPEALING ALL OTHERS; PROVIDING FOR AUTHORIZATION AND APPROVAL; PROVIDING AN EFFECTIVE DATE.

WHEREAS, Section 90-77 of the Town of Surfside Code of Ordinances established a trust fund to be entitled the "Town of Surfside Downtown Parking Trust Fund" to be maintained and administered by the Town Manager; and

WHEREAS, Resolution No. 10-1991 adopted on December 14, 2010, approved a per parking space fee; and

WHEREAS, the Town has caused to be completed a study of the costs to the Town of providing parking spaces, and has determined that the prior established per space fee is outdated and no longer reflects the actual costs of providing for a single structured off-street parking space; and

WHEREAS, the Town Commission of the Town of Surfside finds it is in the public interest to adopt a Downtown Parking Trust Fund per parking space fee of thirty-eight thousand dollars (\$38,000).

NOW, THEREFORE, BE IT RESOLVED BY THE TOWN COMMISSION OF THE TOWN OF SURFSIDE, FLORIDA, THAT:

Section 1. Recitals. That the above and foregoing recitals are true and correct and are incorporated herein by reference.

Section 2. Approval and Adoption. The Town Commission approves and adopts the Downtown Parking Trust Fund per parking space fee of thirty-eight thousand dollars (\$38,000) for the Town of Surfside that may be payable in accordance with the terms set forth in Sec. 90-77 of the Town of Surfside Code of Ordinances.

Section 3. Repeal of Prior Fees. All other per space parking fees established under Section 90-77 of the Surfside Code of Ordinances are hereby repealed.

Section 4. Authorization. The Town Commission authorizes the Town Manager and Town Attorney to do whatever is necessary to effectuate the terms of this Resolution.

Section 5. Effective Date. This Resolution shall become effective immediately upon its adoption.

PASSED and **ADOPTED** on this 12th day of August, 2014.

Motion by Commissioner Olchyk, Second by Vice Mayor Tourgeman.

FINAL VOTE ON ADOPTION

Commissioner Barry R. Cohen
Commissioner Michael Karukin
Commissioner Marta Olchyk
Vice Mayor Eli Tourgeman
Mayor Daniel Dietch

Yes
Absent
Yes
Yes
Yes



Daniel Dietch, Mayor

ATTEST:

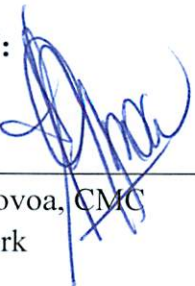

Sandra Novoa, CMC
Town Clerk

**APPROVED AS TO FORM AND
LEGAL SUFFICIENCY FOR THE TOWN OF SURFSIDE ONLY:**



Linda Miller, Town Attorney

TOWN OF SURFSIDE
 BUILDING & ZONING DEPARTMENT/ HOURS 9:00AM - 4:00PM
 9293 HARDING AVENUE
 SURFSIDE, FL 33154
 (305) 361-4863

Permit Number 14-00000509 Date 11/12/15
 Property Address 9540 GB COLLINS AVE
 PARCEL NUMBER: 2 -3-6-0 -0 /3 /ADM6
 FOLIO NUMBER: 1422350070200
 Permit description NEW BUILDINGS-COMMERCIAL
 Property Zoning MULTI-FAMILY
 Permit valuation 13687447

Owner

SHUL OF BAL HARBOUR
 9540 COLLINS AVENUE
 SURFSIDE FL 33154

Contractor

A.V.I CONTRACTORS, INC.
 1442 BLUE JAY CIRCLE
 ATT: VINCENT MISH
 FT. LAUDERDALE FL 33327
 (954) 557-6249

--- Structure Information 000 000 SOCIAL HALL AND LEARNING CENTER
 Construction Type CONCRETE BLOCK
 Occupancy Type COMMERCIAL
 Roof Type BUILT-UP
 Flood Zone AE AT 9 FEET
 Sign Type CONSTRUCTION SIGN
 Fence Type CONSTRUCTION FENCE

Permit NEW COMMERCIAL BLDG/ADDT, ETC
 Additional desc 1&3 STORIES/SOCIAL HALL/CENTER
 Permit Fee 195766.77 Plan Check Fee00
 Issue Date 11/12/15 Valuation 0
 Expiration Date 5/10/16

Qty	Unit Charge	Per	Extension
		BASE FEE	195766.77

Special Notes and Comments

SEPARATE PERMITS MUST BE PULLED FOR THE
 FOR WINDOWS; ROOF; PAVING & CURB CUTS;
 ELECTRICAL; MECHANICAL; PLUMBING; POOL
 FENCE; SIGNS; FIRE & LAWN SPRINKLER
 SYSTEMS; NO CERTIFICATE OF OCCUPANCY
 WILL BE ISSUED UNTIL TEMPORARY STRUCTURE
 USED INCIDENTAL TO THE CONSTRUCTION OF
 THE PRIMARY STRUCTURE HAVE BEEN REMOVED

0094G/1-20-93/AE-8

Other Fees	COUNTY PERMIT FEE	8212.80
	STRUCTURAL ENGINEER FEES	1000.00

Fee summary	Charged	Paid	Credited	Due
Permit Fee Total	195766.77	195766.77	.00	.00
Plan Check Total	.00	.00	.00	.00

TOWN OF SURFSIDE
BUILDING & ZONING DEPARTMENT/ HOURS 9:00AM - 4:00PM
9293 HARDING AVENUE
SURFSIDE, FL 33154
(305)861-4863

Permit Number	14-00000509		Page	2
Other Fee Total	9212.80	9212.80	Date	11/12/15
Grand Total	204979.57	204979.57		.00
				.00

BUILDING DEPARTMENT CLERK: _____

AUTHORIZED SIGNATURE: _____





TOWN OF SURFSIDE

03/28/14 02:10PM

14-509

PERMIT NO.

APPLICATION NO.

AMOUNT DUE

BUILDING PERMIT APPLICATION

2010 FLORIDA BUILDING CODE IN EFFECT

PERMIT TYPE: (Check one)

- Structural
 Mechanical
 Electrical
 Plumbing
 Other
 Roof

JOB ADDRESS: 9540 COLLINS AVE			
OWNER'S NAME: THE SHUL OF BAY HARBOUR INC.			
OWNER'S ADDRESS: 9540 COLLINS AVE.			
CITY: SURFSIDE FL.		PHONE# 305.868.1411	FAX #
FEE SIMPLE TITLE HOLDER'S NAME:		ADDRESS:	
CONTACT PERSON: YANKIE ANDRUSIER PHONE# 347.723.2731			
EMAIL ADDRESS: YANKIE@ownersrepofmiami.com			
CONTRACTOR: A.V.I. Contractors, Inc. (11/10/15)			
MAIL ADDRESS: 2771 Executive Park Drive Suite 2			
CITY: Weston		STATE FL.	ZIP CODE: 33331
PHONE # 954-557-6249		FAX # 954-217-1818	EMAIL: Vincent@AviContractorsInc.com
CERT COMPETENCY: CGC 1508145		STATE REGISTRATION:	
LOT	BLOCK	PRESENT USE:	PROPOSED USE: Synagogue
FOLIO NUMBER:		SUBDIVISION:	
NO. OF STORIES: 3	OFFICES:	FAMILIES:	BEDROOMS: BATHS:
TYPE OF WORK:	ADD <input type="checkbox"/>	NEW <input type="checkbox"/>	ALTER <input type="checkbox"/>
	REPAIR <input type="checkbox"/>	REPLACE <input type="checkbox"/>	OTHER <input type="checkbox"/>
VALUE OF WORK: (Total all Trades): \$13,687,447.00		SQ. FT. (TOTAL)	LINEAR FEET
DESCRIBE WORK: ONE AND THREE STORIES SOCIAL HALL AND LEARNING CENTER			
ARCHITECT/ENGINEER'S NAME: SETHAPIRO ASSOCIATES			
ADDRESS: 1150 KANE CONCOURSE, BAY HARBOUR, FL 33154			
PHONE# 305.866.7324		FAX# 305.866.7474	EMAIL: jame@schapiroassociates.com
MORTGAGE LENDER NAME:			

Ext. 212

MIAMI BEACH

Miami Beach failed to collect \$19 million in developer fees for parking

By Joey Flechas

jflechas@MiamiHerald.com

SEPTEMBER 16, 2014 07:06 PM, UPDATED SEPTEMBER 18, 2014 03:21 PM



Officials at Miami Beach City Hall have uncovered past mismanagement of a program that allows developers who can't provide on-site parking to pay the city a fee for every space they can't provide. The city could have collected nearly \$19 million. JOEY FLECHAS MIAMI HERALD STAFF



Listen to this article now

04:14 Powered by Trinity Audio

In Miami Beach, a town known for its scarcity of parking, city staffers have failed to collect nearly \$19 million in fees from developers — fees that were supposed to be used to improve the city's parking facilities.

City administrators uncovered the problem, which stretches back 25 years, through an eight-month internal review, the results of which were released Tuesday. Administrators will present the findings of the internal investigation to the City Commission Wednesday evening.

Since January, the city's planning department has reviewed processes and procedures in the "fee in

We may use cookies, beacons (also known as pixels), and other similar technologies (together "cookies") to offer you a better experience, serve you more relevant ads, and analyze usage. By continuing to use this application, you consent to the use of cookies in accordance with our Privacy Policy.

ACCEPT COOKIES



Pharrell just dropped \$30 million on sweet ‘quarantine’ digs in Coral Gables: report

That fee, currently set at \$35,000 per space, is supposed to go toward improving the city’s parking facilities. An annual fee is also charged if a change to an existing property requires more parking, like if a restaurant adds more tables. That fee is set at \$700 per year for as long as that use remains.

Local news has never been more important

Subscribe for unlimited digital access to the news that matters to your community.

#READLOCAL

According to a memo sent Tuesday afternoon to the City Commission, the review uncovered issues with billing, accounting and inspection of properties in the program, which led to the city leaving \$18.9 million on the table over the course of the past 20 years. It started with reviewing a sample of 25 accounts in the program at the beginning of this year. The pool ballooned to about 180 accounts after staffers kept finding problems.

The news comes about a week after the Miami Herald reported that [past Miami Beach administrators failed to collect \\$2.7 million in water and sewer connection fees from several hotels and condos](#). It does not appear there is any connection between the two instances of mismanagement.

Officials reviewing the parking fee program also found that the city did little or nothing after three previous internal audits revealed some of the management issues in 1997, 2003 and 2010.

“Management responses for corrective action did not have completion dates and there is no evidence that significant and deliberate steps were taken by any of the departments involved to establish the appropriate checks and balances to prevent recurrence or initiate invoicing of recurring fees to prevent further loss,” reads the memo, prepared by Deputy Planning Director Carmen Sanchez and Assistant City Manager Joe Jimenez.

The one-time fee has increased incrementally over the years. In many cases, records show past planning officials agreed to bill property owners at previous lower rates without explanation. In

We may use cookies, beacons (also known as pixels), and other similar technologies (together "cookies") to offer you a better experience, serve you more relevant ads, and analyze usage. By continuing to use this application, you consent to the use of cookies in accordance with our Privacy Policy.

ACCEPT COOKIES

financial system.

The review is ongoing.

“Staff has conducted extensive research and has had to reconstruct the history for most of the accounts evaluated,” reads the memo. “As new details come to light and additional information is received the estimated receivable amount may change to include other projects identified at a future date.”

The history of poor management came to light to city officials earlier this year, when Sanchez, hired in late 2013, and Jimenez, who joined the city in May 2013, initiated a review of the program. The current administration has already put some checks and balances in place to fix the problems.

According to the memo, the planning department has invoiced 34 recurring accounts for the current fiscal year, and will start invoicing all active accounts for the upcoming fiscal year, starting Oct. 1. The city has updated its permitting software to keep records of what is charged and owed, hired staff to manage special revenue accounts like the parking impact fee program and, from now on, building permits or certificates of use will not be issued until the fee has been paid.

City administrators did not want to comment for this story before presenting their findings to the City Commission. Administrators will ask the City Commission for direction on how to proceed with uncollected money from current businesses and ones that have closed but still have outstanding balances.

Follow [@joeflech](#) on Twitter.

RELATED STORIES FROM MIAMI HERALD

MIAMI-BEACH

Miami Beach to develop plan to recover unpaid developer fees

SEPTEMBER 17, 2014 8:21 PM

MIAMI-BEACH

Miami Beach failed to collect millions in water and sewer fees from new hotels and condos

SEPTEMBER 07, 2014 2:59 PM

MIAMI-BEACH

Miami Beach agrees to increase storm-drainage fees

SEPTEMBER 10, 2014 3:42 PM

MIAMI-BEACH

City commission approves body cameras for employees

SEPTEMBER 10, 2014 7:12 PM

FROM OUR ADVERTISING PARTNERS



How Dogs Cry for Help: 3 Warning Signs Your Dog is Crying for Help
DR. MARTY



Americas #1 Futurist 2020 Prediction Will Stun You
INTERNET REBOOT 2020



MD: If You Have Toenail Fungus, Do This Immediately (Watch)
CLEAR NAIL PLUS

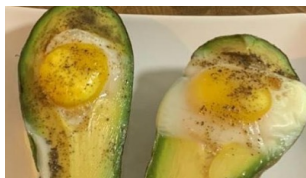

ACCEPT COOKIES

We may use cookies, beacons (also known as pixels), and other similar technologies (together "cookies") to offer you a better experience, serve you more relevant ads, and analyze usage. By continuing to use this application, you consent to the use of cookies in accordance with our Privacy Policy.

COMMENTS ▾



Big crowds at Miami Beach parks, marinas on first weekend of reopening



Food distributions help Miami Beach families

[VIEW MORE VIDEO →](#)

TRENDING STORIES

After six weeks of lockdown, Miamians enjoy first weekend of reopened parks, marinas

UPDATED 9 HOURS 35 MINUTES AGO

Pieces of Halley's Comet will streak across the night sky this week. Here's what to know

UPDATED MAY 02, 2020 02:06 PM

Biden, Warren: There's no oversight of coronavirus relief — because that's what

We may use cookies, beacons (also known as pixels), and other similar technologies (together "cookies") to offer you a better experience, serve you more relevant ads, and analyze usage. By continuing to use this application, you consent to the use of cookies in accordance with our Privacy Policy.

[ACCEPT COOKIES](#)

THIS DAY IN HISTORY

1990

Brooks Koepka, the American golfer, is born.

3 MAY

THIS DAY IN HISTORY

Royal Caribbean falsely blames CDC for keeping crew trapped on its ships, agency says

UPDATED MAY 01, 2020 10:22 PM

After refusing for weeks, Florida releases nursing home records, showing flurry of deaths

UPDATED MAY 02, 2020 06:29 PM

READ NEXT



MIAMI-DADE COUNTY

After six weeks of lockdown, Miamians enjoy first

We may use cookies, beacons (also known as pixels), and other similar technologies (together "cookies") to offer you a better experience, serve you more relevant ads, and analyze usage. By continuing to use this application, you consent to the use of cookies in accordance with our Privacy Policy.

ACCEPT COOKIES

Page 380



Saturday brought crowds at Miami-Dade County marinas and parks, which opened Wednesday after weeks of being closed due to coronavirus. At Blackpoint Marina, hundreds of cars lined up to go boating and fishing.

KEEP READING →

Local news has never been more important

#ReadLocal

Subscribe for unlimited digital access to the news that matters to your community.

#READLOCAL

MORE MIAMI BEACH



MIAMI BEACH

Miami Beach rejects beach-opening plan, but new COVID testing site gives leaders hope

UPDATED MAY 01, 2020 09:00 PM



MIAMI BEACH

After Facebook fight draws criticism, Miami Beach commissioner announces \$17K donation

UPDATED MAY 01, 2020 05:05 PM



REAL ESTATE NEWS

Instagram sensation Gianluca Vacchi lists his Miami Beach home for \$10.9M

UPDATED MAY 01, 2020 03:30 PM



MIAMI BEACH

More than 1,550 face-mask warnings issued in Miami Beach parks after reopenings

UPDATED MAY 01, 2020 04:41 PM



MIAMI BEACH

Miami Beach man accused of raping a 16-year-old girl in apartment stairwell

UPDATED MAY 01, 2020 04:31 AM



SPONSORED CONTENT

8 Things You Didn't Realize You Could Do to Pay off Debt

BY THE PENNY HOARDER

Take Us With You

Real-time updates and all local stories you want right in the palm of your hand.



MIAMI HERALD APP →

We may use cookies, beacons (also known as pixels), and other similar technologies (together "cookies") to offer you a better experience, serve you more relevant ads, and analyze usage. By continuing to use this application, you consent to the use of cookies in accordance with our Privacy Policy.

Page 381

ACCEPT COOKIES

SUBSCRIPTIONS

- Start a Subscription
- Customer Service
- eEdition
- Vacation Hold
- Pay Your Bill

LEARN MORE

- About Us
- Contact Us
- Newsletters
- News in Education
- Public Insight Network
- Reader Panel
- Archives

ADVERTISING

- Place a Classified
- Media Kit
- Public Notices

COPYRIGHT

COMMENTING POLICY

PRIVACY POLICY

TERMS OF SERVICE

We may use cookies, beacons (also known as pixels), and other similar technologies (together "cookies") to offer you a better experience, serve you more relevant ads, and analyze usage. By continuing to use this application, you consent to the use of cookies in accordance with our Privacy Policy.

ACCEPT COOKIES



TOWN OF SURFSIDE, FLORIDA

**REQUEST FOR PROPOSALS (RFP)
POINT LAKE CANAL SUBAQUEOUS WATER
MAIN CROSSING TO BISCAYA ISLAND
RFP No. #####-##**

Issue Date: **January** ____, 2020

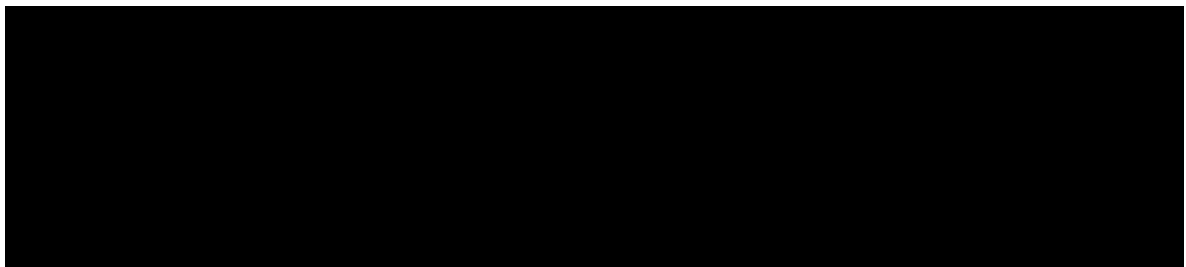

TABLE OF CONTENTS

ARTICLE	PAGE No.
Public Notice – Request for Proposals	3
Article 1 – Definition of Terms	5
Article 2 – Introduction	7
Article 3 – Proposal Instructions	10
Article 4 – Information Required in Proposals	16
Article 5 – Procedure and Criteria for Evaluating Bid Proposals	22
Article 6 – Execution of Agreement and Completion of Work	24
Article 7 – General Information and Administrative Requirements	25
Article 8 – Design Criteria Package <div style="padding-left: 40px;">Exhibit 1 - Location Map of Community Center</div> <div style="padding-left: 40px;">Exhibit 2 - Design Criteria Plans (Exhibit A thru E)</div> <div style="padding-left: 40px;">Exhibit 3 – Recent FPL Bill</div>	26
Article 9 – Proposer’s Acknowledgements	30
Article 10 – Representations	30
FORMS	
FORM 1 – Proposal Checklist	31
FORM 2 - Proposal Cover Sheet	32
FORM 3 – Project Cost Proposal	35
FORM 4 – Proposal Bond – Proposer Surety	37
FORM 5 – Statement of Qualifications & Supplemental Forms	40
FORM 6 – Sworn Statement – Public Entity Crimes	50
FORM 7 – Non-Collusion Affidavit	53
FORM 8 – Non-Discrimination Affidavit	54
FORM 9 – References	55



PUBLIC NOTICE

Request for Proposals (RFP) No. 2020-01 **Design/Build of Community Center Photovoltaic System**

NOTICE IS HEREBY GIVEN that the Town of Surfside is soliciting sealed proposals for the Design/Build of the Community Center Photovoltaic System in Surfside, Florida. Interested firm/individuals (“Proposer (s)”) may pick-up a copy of the Request for Proposals (“RFP”) No. 2020-01 from the Town Clerk’s Office, Town of Surfside, Town Hall, 9293 Harding Avenue, Second Floor, Surfside, Florida, 33154, or may download it from the Town’s website at www.townofsurfside.fl.gov. The RFP contains detailed and specific information about the scope of services, submission requirements, and selection procedures.

One (1) original, five (5) hard copies, and one (1) electronic copy on a USB drive of the completed and executed Proposal must be delivered no later than _____, 2020, at **2:00 PM** (“Submission Deadline”) to the following address:

**Town of Surfside Town Hall
Town Clerk’s Office
9293 Harding Avenue, Second Floor
Surfside, Florida, 33154.**

The Town reserves the right to reject late submissions, in the sole discretion of the Town Manager or his designee.

The envelope containing the sealed Proposal must be clearly marked as follows:

**SEALED PROPOSAL
RFP NO. 2020-01
DESIGN/BUILD OF COMMUNITY CENTER PHOTOVOLTAIC SYSTEM
OPENING DATE AND TIME/SUBMISSION DEADLINE: _____, 2020, at 2:00 PM**

A **Mandatory Pre-RFP Submission Conference** is scheduled for _____, 2020 at **2:00 pm** at the Town of Surfside Town Hall, 9293 Harding Ave., Second Floor, Surfside, Florida 33154. All Proposers planning to submit Proposals are required to attend this meeting. Proposers should allow sufficient time to ensure arrival prior to the indicated time. Proposals from those who have failed to attend will not be accepted. All persons attending the pre-submission conference may ask questions or seek clarification regarding this RFP via the procedures outlined herein.

Any questions or clarifications concerning the proposal specifications must be received by Sandra Novoa, MMC Town Clerk, no later than 5:00 PM, _____, 2020. Any questions regarding RFP No. 2020-01 are to be submitted either in writing directly to Sandra Novoa, Town Clerk, at the following address: 9293 Harding Ave., Second Floor, Surfside, Florida 33154, or via email to: snovoa@townofsurfsidefl.gov. Any questions received by the Clerk after the stated deadline will be disregarded. All questions received by the Clerk prior to the stated deadline shall be answered via an Addendum to this RFP and circulated to all registered Proposers.

The Town shall award the contract in a manner consistent with the Florida statutory requirements for Design/Build public contracts. The Proposer must be a qualified design/build firm as defined in Section 287.055, Florida Statutes. The Town of Surfside intends to enter into a Design/Build Agreement with the successful Proposer for design/build of a roof-mounted Photovoltaic System at the Town's Community Center located at 9301 Collins Avenue, Surfside, Florida 33154.

The Town reserves the right to reject any or all proposals, with or without cause, to cancel this solicitation, to waive technical errors and informalities, and to accept any proposal which best serves the interests of or represents the best value to the Town.

The Town of Surfside hereby provides notice to all proposers of the adoption and imposition of a Cone of Silence for this solicitation, as set forth in Section 3-17 of the Town Code. "Cone of Silence," as used herein, means a prohibition on communication regarding a competitive bid or solicitation for a purchase exceeding \$25,000.00, including but not limited to, a particular request for proposal ("RFP") between: (1) A potential respondent, vendor, service provider, proposer, bidder, lobbyist, or consultant, and (2) The Town commissioners, Town's staff including, but not limited to, the Town Manager and his or her staff, any member of the Town's selection or evaluation committee. Please contact the Town Clerk and/or Town Attorney with any questions on the Cone of Silence.

Date Issued: _____, 2020

Request for Proposals (RFP) No. 2020-01
Design/Build of Community Center Photovoltaic System

INSTRUCTIONS

ARTICLE 1
DEFINITION OF TERMS

The terms defined in this Article and the Design/Build Agreement shall apply to all documents contained in the proposal and contract documents for this project. If a conflict exists, the definitions in the Design/Build Agreement supersede definitions provided in the proposal and contract documents.

- 1.1 “Addenda” or “Addendum” mean a written modification to this RFP issued by the Town covering changes, additions, or reductions in the terms of this RFP.
- 1.2 “Amendment” means a written modification to the Contract Documents covering changes, additions, or reductions in the terms of the Contract Documents.
- 1.3 “Bidder” or “Proposer” means a person or entity that timely submits a responsive Project proposal or bid.
- 1.4 “Consultant” or “Project Consultant” both shall be that certain party that the Town may engage to be an owner’s representative for the Project.
- 1.5 “Contract Documents” means this RFP, the Design/Build Agreement, Design Criteria Package, the Plans and Specifications and all exhibits and documents related thereto or contemplated thereby, as well as all Addenda and Amendments related to each with respect to the Project and all changes to said documents issued by the Town.
- 1.6 “County” means Miami-Dade County.
- 1.7 “Day” means consecutive days of the week or month without regard to weekends or holidays.
- 1.8 “Design/Builder” or “Design/Build Firm” means the successful Proposer on this Project who is qualified under Section 287.055, Florida Statutes.
- 1.9 “Design/Build Agreement” means that agreement to be entered into between the Town and the successful Proposer for the Work. The form of the Design/Build Agreement will be available to all proposers in advance of the Submittal Date on the Town’s website www.townofsurfsidefl.gov and/or issued by Addendum to this RFP.

- 1.10 “Design Criteria Package” shall mean the design/build specifications and criteria for the Project prepared by the Town’s Design Criteria Professional as specified in Section 287.055, Florida Statutes, and attached as Exhibits 1 and 2.
- 1.11 “Design Criteria Professional” shall mean the professional engineer preparing the Design Criteria Package, as specified in Section 287.055, Florida Statutes.
- 1.12 “Design Services” are all design services performed by and required of the Design/Builder pursuant to this RFP and the Contract Documents and includes services performed by the Design/Builder’s Subconsultants.
- 1.13 “FDOT” means the Florida Department of Transportation.
- 1.14 “Guaranteed Maximum Price” means the lump sum price for the Work, and is the maximum amount the Town shall be required to pay the Design/Builder for the performance of all obligations described in the Contract Documents.
- 1.15 “Payment Bond” shall be in the form required in this RFP.
- 1.16 “Performance Bond” shall be in the form required in this RFP.
- 1.17 “Project” means the design and construction, in accordance with this RFP and the Contract Documents, of the Community Center roof-mounted Photovoltaic System.
- 1.18 “Project Cost Proposal” means the guaranteed maximum price for which the Proposer offers to perform the Work, as described in the Contract Documents in the form attached hereto as Form “3”.
- 1.19 “Project Location” or “Project Site” means the area where the Project is to be constructed, as shown on Exhibit 1 (Location Map of Community Center located at 9301 Collins Avenue, Surfside, Florida).
- 1.20 “Proposal/Bid Proposal” means the Technical Proposal and the Project Cost Proposal submitted together by the Proposer in response to this RFP.
- 1.21 “Proposal Security” or “Proposal Bonds” shall mean a cashier’s check or bond submitted by a Proposer in the form attached hereto as Form “4”.
- 1.22 “RFP” means this Request for Proposal.
- 1.23 “Selection Committee” shall be appointed by the Town Manager and shall review and evaluate responsive Proposals.
- 1.24 “Short Listed Firms” shall be the top Proposers recommended by the Selection Committee to the Town Manager and/or Town Commission.

- 1.25 “Short Listed Firm’s Proposal” or “Short Listed Firm’s Presentation” shall both mean all documents submitted by a Short Listed Firm, and that firm’s oral presentation.
- 1.26 “State” shall mean the State of Florida.
- 1.27 “Subconsultant” means any person or entity, other than Design/Builder’s own employees, employed or retained by, or under contract with Design/Builder to perform a portion of the Design Services under this RFP and the Contract Documents.
- 1.28 “Subcontractor” means any person or entity, other than the Design/Builder’s own employees, employed or retained by, or under contract with the Design/Builder to perform the non-design portion of the Work under this RFP and the Contract Documents.
- 1.29 “Technical Proposal” shall mean all information required to be submitted by the proposer for this RFP to be considered responsive, except the Project Cost Proposal.
- 1.30 “Town” or “Owner” means the Town of Surfside, a Florida municipal corporation.
- 1.31 “Town’s Representative” shall be the person designated by the Town as the Town’s contact person.
- 1.32 “Work” includes all aspects of the design and construction project proposed in this RFP, the Contract Documents and other bidding documents.

ARTICLE 2
INTRODUCTION, BACKGROUND, PROJECT DESCRIPTION,
AND SCOPE OF SERVICES

2.1 INTRODUCTION

- 2.1.1 The Town of Surfside, Florida (“Town”), a municipality located in Miami-Dade County, Florida, requests qualified Design/Build Proposers (“Proposers”) to submit proposals to design and build a roof-mounted Photovoltaic System (also known as solar panels) in the Town’s Community Center located at 9301 Collins Avenue, Surfside, Florida 33154.
- 2.1.2 The Town desires to contract with a qualified Design/Build Firm to design and construct the Project.
- 2.1.3 The Town intends to award the Design/Build Agreement to a qualified entity that the Town Commission determines to be in the best interest of and most advantageous to the Town.

2.1.4 The Work required under this RFP is defined in this RFP, which includes the Design Criteria Package, and the Contract Documents.

2.2 **BACKGROUND.** The Town is located on a barrier island in northeast Miami-Dade County, Florida, situated between Miami Beach to the south and Bal Harbour Village to the north, and is bounded on the east by the Atlantic Ocean, on the west by Atlantic Intracoastal Waterway, on the south by 87th Terrace, and on the north by 96th Street. The Town’s standards stress high-quality visual corridors to the ocean, with access to the ocean, as well as a focus on protecting the environment, providing landscaping, and developing aesthetically attractive structures.

2.3 **PROJECT DESCRIPTION.** The project site is the Town Community Center located at: 9301 Collins Avenue, Town of Surfside, Florida 33154. The solar system shall be comprised of an array of photovoltaic panels and electrical equipment components capable of generating a minimum of 93.6 kWdc to maximize savings.

Currently The Town of Surfside Community Center uses 396,960 kWh annually. The energy usage is as follows:

Month	Energy Usage (kWh) per FPL Billing
December 2018	28,920
January 2019	27,960
February 2019	31,320
March 2019	32,640
April 2019	34,560
May 2019	37,080
June 2019	39,720
July 2019	36,960
August 2019	34,200
September 2019	37,560
October 2019	28,440

Refer to Exhibit 3 for recent FPL Bill

2.4 SCOPE OF SERVICES.

The successful Design-Build Proposer shall design, permit, and construct the improvements necessary for:

- 1) The installation of a roof-mount solar photovoltaic system at the site address. The solar system shall be comprised of an array of photovoltaic panels and electrical equipment components generating a minimum of 93.6 kWdc to maximize savings.

- 2) The structural installation of the solar panels and components to the existing building roof.
- 3) The proposer shall develop a design for a new photovoltaic system. Not all locations identified need to be utilized. It is the responsibility of the proposer to assess the building structural integrity, roof condition, and shading limitations.
- 4) Mounting system shall limit roof penetrations or be fully ballasted. Mounting system design needs to meet applicable local building code requirements with respect to snow, wind, and earthquake factors. Solar system installation must not void the roof warranty.
- 5) Roof conduit penetrations shall be minimized and the new PV electrical equipment shall fit into the existing electrical room.
- 6) System shall be fixed tilt with an orientation that maximizes annual savings.
- 7) Monitoring of system performance and providing public education and outreach is an important element. The Town of Surfside will favor a proposal that includes a turnkey monitoring system that can be integrated into the Town of Surfside's computer system for display on the Town of Surfside website. The system should display and analyze historical and live solar electricity generation data. Additionally, the regularly collected data should reflect, but not be limited to, the following:
 - Average and accumulated output (kWh/kW and total kWh)
 - Capacity factor
 - Air quality emissions averted (and real world equivalents conversion)
- 8) Provide operation and maintenance of the entire solar electric system for 20 years. Operations and maintenance services shall include:
 - Online monitoring
 - Performance monitoring, notification, and troubleshooting – must have personnel available to notify Town of Surfside of an outage or decrease in system production
 - Corrective maintenance to mitigate any risk to the system or minimize down time
 - System Performance Reports that compares actual production to predicted production
 - Preventative maintenance and inspections to identify and fix problems before they occur, including infrared photography for hot spots, manufacturer recommended maintenance, hardware torque checks, and array cleanings

The successful proposer shall prepare and submit design plans, renderings, technical specifications, and materials/PV components-package shop-drawings as necessary to adequately define and portray a fully functional, code-compliant, and operational PV system, and shall

subsequently apply for and obtain all necessary permits required to complete the installation and operation of the system and all of its components. The successful proposer must have worked with Florida Power and Light (FP&L) regulations and have established onsite safety standards.

The design plans shall be submitted for review at 30%, 60%, 90%, and 100%. The technical specifications shall be submitted for review at 60%, 90%, and 100%. The design specifications and plans shall be submitted for review to the Town's Director of Public Works for prior to the filing of permit applications. Such documents shall adequately demonstrate to the Director of Public Works that the PV components, controls, appurtenances, and interconnections will provide a fully functional and controllable system which will operate in accordance with the Town's intentions, as outlined herein. After approval of the products/systems by the Director, no substitutions of materials, systems, or components will be allowed without prior approval of the Director. Once the plans have been approved by the Town's Director of Public Works, they shall be submitted to the Building Department and any other agency having jurisdiction for approval and construction permitting. All permit fees and associated costs for pursuing and obtaining required approvals and permits shall be the responsibility of the Proposer and shall be included in the Proposer's proposal price submitted in response to this RFP.

All work shall be performed and completed in compliance with the National Electric Code (NFPA 70), the Florida Building Code, Miami-Dade County Code, Town of Surfside Charter and Code, and all other applicable codes and standards governing the work. The applicable edition of each code shall be that edition which is adopted and in effect at the time of filing of the last permit application governed by each code or standard.

All permit fees and associated costs for obtaining required approvals and permits for the Work shall be the responsibility of the Proposer and shall be included in the Proposer's Cost Proposal submitted in response to this RFP.

ARTICLE 3 PROPOSAL INSTRUCTIONS

- 3.1 Copies of this RFP may be obtained from the Town. Proposers who obtain copies of this Proposal from sources other than the Town risk not receiving Addenda, since their names may not be included on the list of firms participating in the process for this particular RFP.
- 3.2 **CONE OF SILENCE.** Notwithstanding any other provision of these specifications, the provisions of Town "Cone of Silence" are applicable to this transaction. The "Cone of Silence", as used herein, means a prohibition on any communication regarding a particular Request for Proposal (RFP), Request for Qualification (RFQ), or bid, between a potential vendor, service provider, contractor, bidder, lobbyist, or consultant, and the Town Commission, Town's professional staff including, but not limited to, the Town

Manager and his or her staff, any member of the Town's selection or evaluation committee.

The Cone of Silence shall be imposed upon each RFP, RFQ, and bid after the advertisement of said RFP, RFQ, or bid.

The Cone of Silence shall terminate at time the Town Manager makes his or her written recommendation to the Town Commission. However, if the Town Commission refers the Manager's recommendation back to the Manager or staff for further review, the Cone of Silence shall be re-imposed until such time as the Manager makes a subsequent written recommendation.

The Cone of Silence shall not apply to:

1. Oral communications at pre-proposal/pre-bid conferences.
2. Oral presentations before selection or evaluation committees.
3. Public presentations made to the Town Commission during any duly noticed public meeting.
4. Communications in writing at any time with any town employee, unless specifically prohibited by the applicable RFP, RFQ, or bid documents. The bidder or proposer shall file a copy of any written communication with the Town Clerk. The Town Clerk shall make copies available to any person upon request.
5. Communications regarding a particular RFP, RFQ, or bid between a potential vendor, service provider, contractor, bidder, lobbyist or consultant and the Town's Purchasing Agent or Town employee designated responsible for administering the procurement process of such RFP, RFQ or bid, provided the communication is limited strictly to matters of process or procedure already contained in the corresponding solicitation document.
6. Communications with the Town Attorney and his or her staff.
7. Duly noticed site visits to determine the competency of bidders regarding a particular bid during the time period between the opening of bids and the time the Town Manager makes his or her written recommendation.
8. Any emergency procurement of goods or services pursuant to Town Code.
9. Responses to the Town's request for clarification or additional information.
10. Contract negotiations during any duly noticed public meeting.

11. Communications to enable Town staff to seek and obtain industry comment or perform market research, provided all communications related thereto between a potential vendor, service provider, contractor, bidder, lobbyist, or consultant and any member of the Town's professional staff including, but not limited to, the Town Manager and his or her staff are in writing or are made at a duly noticed public meeting.

Please contact the Town Attorney for any questions concerning Cone of Silence compliance.

Violation of the Cone of Silence by a particular bidder or proposer shall render any RFP award, RFQ award, or bid award to said bidder or proposer voidable by the Town Commission and/ or Town Manager

- 3.3 **MANDATORY PRE-SUBMITTAL CONFERENCE.** A Mandatory Pre-Submittal Conference is scheduled for _____, 2020 at 2:00 pm at the Town of Surfside Town Hall, Second Floor, 9293 Harding Avenue, Surfside, Florida 33154. All Proposers planning to submit Proposals are required to attend this meeting. Proposers should allow sufficient time to ensure arrival prior to the indicated time. Proposals from those who have failed to attend may not be accepted.

- 3.4 **ADDITIONAL INFORMATION OR CLARIFICATIONS; ADDENDA.** Requests for additional information or clarifications must be received by **Sandra Novoa, M.M.C. Town Clerk, no later than 5:00 PM, on _____, 2020.** Any questions regarding this RFP No. 2020-01 are to be submitted either in writing to the Town Clerk's Office, Surfside Town Hall, 9293 Harding Ave., Second Floor, Surfside, Florida 33154, or via e-mail directly to Sandra Novoa, Town Clerk, snovoa@townofsurfsidefl.gov, in accordance with the deadline for receipt of questions, as also specified in the Public Notice Section of this RFP. The request for additional information and clarification must contain the RFP number and title, Proposer's name, name of Proposer's contact person, address, phone number, and e-mail. No verbal communications shall be binding; only written Addendum from the Town shall be binding. The Town will issue responses to inquiries and any other corrections or amendments it deems necessary in written addenda issued prior to the Proposal deadline. All persons attending the mandatory pre-bid conference will receive the Town's responses. Proposers should not rely on any representations, statements or explanations other than those made in this RFP or in any written addendum to this RFP. Where there appears to be a conflict between the RFP and any addenda issued, the last addendum issued shall govern and prevail.

- 3.5 **SUBMITTAL OF PROPOSAL.** The submittal shall consist of one sealed Proposal package. The package shall include the Project Cost Proposal in a separate sealed envelope and a complete original Technical Proposal. Each Proposer shall submit one (1) original, and five (5) additional complete hard copy proposals, and one (1) electronic copy on a USB drive. Proposals shall be as thorough and detailed as possible so that the Town may properly evaluate the capabilities of respective firms to provide the required design/build services. All submittals must meet or exceed the specifications and requirements provided in the **Design Criteria details in Exhibit 2.** Any deviations must be

submitted in writing for approval. No exceptions will be made after the Design/Build Agreement is executed. All proposals submitted to the Town must be delivered no later than _____, 2020 at 2:00 PM (“Submission Deadline”)to the following address.

**Town of Surfside Town Hall
Town Clerk’s Office
9293 Harding Avenue, Second Floor
Surfside, Florida 33154**

The Town reserves the right to reject late submissions, in the sole discretion of the Town Manager or his designee.

The envelope containing the sealed Proposal must be clearly marked as follows:

**SEALED PROPOSAL
RFP NO. 2020-01
DESIGN/BUILD OF COMMUNITY CENTER PHOTOVOLTAIC SYSTEM
OPENING DATE AND TIME/SUBMISSION DEADLINE: _____, 2020 at 2:00 PM**

No extensions to the submission due date will be granted and Proposals received after this time will be returned unopened.

- 3.5.1 Proposal Packaging - Both parts of the Proposal – Technical Proposal and Project Cost Proposal - shall be submitted in separate opaque plain sealed envelopes, parcels, boxes, or other secure packaging. The outside of the sealed packaging must clearly indicate the Proposer’s name, address, and the name and telephone number of the Proposer’s specific contact person; and must designate whether the package contains the Technical Proposal or the Project Cost Proposal. Any and all packaging must clearly and distinctly identify the Proposal by the RFP number and name: **“RFP No. 2020-01 Design/Build of Community Center Photovoltaic System – “Technical Proposal” and “RFP No. 2020-01 Design/Build of Community Center Photovoltaic System – “Project Cost Proposal”**.
- 3.5.2 For the Project Cost Proposal, if a cost discrepancy exists between the item subtotal costs and the Guaranteed Maximum Price, the value entered as Guaranteed Maximum Price will take precedence. If a cost discrepancy exists between the written value for the Guaranteed Maximum Price and the numerical value, the written value will take precedence.
- 3.5.3 All Proposals shall be submitted on 8½ by 11 paper, type written on one side only with one (1) inch margins on all sides. Each copy of the Technical Proposal package must be individually bound.
- 3.5.4 An officer who is legally authorized to bind the proposing entity into a contractual relationship must sign the Proposals.

3.5.5 The Selection Committee will perform an initial review of all submitted Proposals to determine responsiveness. Any Proposals deemed non-responsive will be disqualified and not subject to further review. In determining responsiveness, the Selection Committee and/or Town Commission reserves the right to waive a non-material informality or irregularity.

3.5.6 This Proposal is irrevocable for one hundred twenty (120) Calendar Days from the RFP Submission Deadline.

3.5.7 The Proposer agrees that should the Proposer be selected to perform the Work, the Proposer shall be bound to perform the Work as specified in the Project Cost Proposal whether or not the Town awards all or a portion of the Work

3.6 CALENDAR OF IMPORTANT DATES

The Town’s proposed calendar of events is listed below. This calendar is for the Town’s and Proposer’s preliminary planning use only and is subject to change.

Date	Event
_____, 2020	Public Notice
_____, 2020, 2:00 pm	Mandatory Pre-Proposal Conference
_____, 2020	Last day to submit questions/clarifications
_____, 2020	Submission Deadline: Proposal due to Town Clerk no later than 2:00 PM
_____, 2020 week	Selection Committee meets to open Technical Proposals and eliminate non-responsive Proposals
TBD	Proposals Under Review. Selection Committee meets to publicly evaluate Proposals and produce Short List
TBD	Presentation by Short-Listed Firms (if required)
TBD	Town Commission Action - Final Ranking - Authorization to negotiate issued to Town Manager
TBD	Town Commission Action – Award of

Date

Event

Design/Build Agreement

Note:

Proposers may be requested to make public presentations at any time during the evaluation process. Public presentations are for the purpose of clarifying Proposals prior to scoring by the Selection Committee or prior to final selection by the Town Commission.

3.7 ELIGIBILITY

3.7.1 All potential Design/Build Firms must be qualified pursuant to Section 287.055, Florida Statutes.

3.7.2 Contractors and Subcontractors must meet additional licensing, certification, and bonding requirements as specified in the Design/Build Agreement and elsewhere in this RFP.

3.7.3 Proposers must submit evidence of proper State and County licensing for all contract work, professional services, and other services required under this RFP prior to the execution of the Design/Build Agreement and shall attach such documentation as attachments to the **Statement of Qualifications (See Form 5)** described below for the purposes of evaluation during the selection process as defined by this RFP.

3.8 NON-RESPONSIVE PROPOSALS

Proposals found to be non-responsive shall not be considered. Proposals may be rejected if found to be in nonconformance with the requirements and instructions herein contained. A Proposal may be found to be non-responsive by reasons, including, but not limited to, failure to utilize or complete prescribed forms, conditional proposals, incomplete proposals, indefinite or ambiguous proposals, failure to meet deadlines and improper and/or undated signatures. Other conditions which may cause rejection of proposals include evidence of collusion among Proposers, obvious lack of experience or expertise to perform the required Work, or meet financial obligations on previous contracts. Proposals will also be rejected if not delivered or received on or before the Submission Deadline.

3.9 WAIVER OF IRREGULARITIES

The Town may waive non-material informalities or irregularities in Proposals received where the correction or waiver of which is not prejudicial to other Proposers. Non-material irregularities are defined as those that will not have an adverse effect on the Town's interest and will not affect the price of the Proposals by giving a Proposer an advantage or benefit not enjoyed by other Proposers.

Proposers shall identify separately all innovative aspects of their proposal. Innovation should be limited to Design-Builder's means and methods, approach to Project, use of new products, new uses for established products.

3.10 TOWN OPTIONS

The Town may, at its sole and absolute discretion, reject any or all Proposals, re-advertise this RFP, postpone or cancel this RFP process at any time, or waive any irregularities in this RFP or in the Proposals received as a result of this RFP.

The determination of the criteria and process whereby Proposals are evaluated, the decision as to who shall receive the Design/Build Agreement award, or whether an award shall ever be made as a result of this RFP, shall be the sole and absolute discretion of the Town.

The submittal of a Proposal will be considered by the Town as constituting an offer by the Proposer to provide the Work described in this RFP.

3.11 RULES, REGULATIONS, AND REQUIREMENTS

All proposers shall comply with all laws, ordinances, and regulations of any Federal, State of Florida, Miami-Dade County, or Town government applicable to submitting a response to this RFP and to providing the Work described herein.

ARTICLE 4 INFORMATION REQUIRED IN PROPOSALS

In order to be deemed responsive, each Proposer shall submit the following information and documents with their proposal:

4.1 **Transmittal Letter:** Each Proposer shall submit a transmittal letter signed by an officer authorized to represent, bid, commit and negotiate for the Proposer. The transmittal letter shall state that the Proposer has read and reviewed the RFP's terms and conditions, and accepts such terms and conditions as binding and enforceable. In addition, the letter shall acknowledge receipt and acceptance of all Addenda to the RFP. The transmittal letter shall state that the Proposer's Proposal is valid for one hundred twenty (120) days from the date of its submission.

4.2 **Proposal Cover Sheet:** Provide the information requested in the **Proposal Cover Sheet attached hereto as Form "2"**.

4.3 **Proposer's Statement of Qualifications:** Provide the information requested in the **Proposer's Statement of Qualifications attached hereto as Form "5"**, including the following:

- 1) The Name and address of company/firm, including, but not limited to, a business overview, financial state of the business, annual revenue for past two years, and

names and addresses of all persons having financial interest in firm and key managerial personnel.

- 2) Proof of authorization from the Florida Secretary of State for the prime design-build firm and all sub-contractors and sub-consultants to transact business in Florida, together with a copy of all applicable licenses and permits required for the Work. Proposer must be fully licensed with all required State and/or local licenses and permits to perform the Work and all services.
- 3) Resumes, with job descriptions and other detailed qualification information, for all key personnel who will be assigned to this project, including any key personnel of sub-consultants and sub-contractors.
- 4) Description of the Proposer's (including sub-consultants' and sub-contractors') experience in the application of Photovoltaic (PV) Technology and implementation of the technical requirements as defined in the Project's Scope of Services. Proposers shall describe and demonstrate their successful deployment of the systems described in the Scope of Services or on systems of similar or greater complexity (illumination scenes and lighting synchronization) to that requested in this proposal.
- 5) Description of the experience, qualifications, and other vital information, including relevant experience on previous similar projects, of all key personnel, including those of sub-consultants and sub-contractors, who will be assigned to this project.
- 6) Detailed description of comparable contracts as they pertain to the Scope of Services similar to that requested herein, which the Proposer and Subcontractor has either ongoing or completed within the past five years. The description should identify for each project: (i) client, (ii) a complete description of work, (iii) total dollar value of the contract, (iv) dates covering the term of the contract, (v) client contact person and phone number, (vi) statement of whether Proposer was the prime contractor or subcontractor, and (vii) the results of the project. Where possible, list and describe those projects performed for government clients or similar size private entities (excluding any work performed for the Town of Surfside).
- 7) List all contracts which the Proposer has performed for the Town of Surfside. The Town will review all contracts the Proposer has performed for the Town. As such, the Proposer must list and describe all work performed for the Town of Surfside and include for each project:

- a. Name of the Town Department which administers or administered the contract;
 - b. Description of work;
 - c. Total dollar value of the contract;
 - d. Dates covering the term of the contract;
 - e. Town contact person and phone number;
 - f. Statement of whether Proposer was the prime contractor or subcontractor; and
 - g. Results of the project.
- 8) Project approach (as outlined in Section 2.4 above) including conceptual renderings, schematic diagrams, technical specifications, shop-drawings or cut sheets of all integral parts (solar panels, control system, etc.), phasing plan, and project schedule. Cut sheets and shop drawings will not count against the page limit.
- 9) The Total Project Cost or price to the Town.

4.4 **Subcontractor and Subconsultant Information:** Provide Subcontractor and Subconsultant information in Form 5, including, but not limited to the identification of any Work, which exceeds either twenty percent (20%) of the design fee or twenty percent (20%) of the construction cost presented in the Project Cost Proposal. Identify the Subcontractors and Subconsultants, the Work to be subcontracted, and the management controls to be used to assure the Subcontractor's or Subconsultant's performance. Subcontracted and Subconsulted Work which is less than twenty percent (20%) of the Project Cost Proposal does not need to be disclosed.

4.5 **References:** For the Proposer, provide all design-build clients in the last five (5) years whether the project is complete or ongoing. For each client reference, include the names, organizational affiliations, titles, addresses and telephone numbers. Also, provide client references for all design and/or construction/installation of photovoltaic systems or projects similar to the one proposed for the last five (5) years whether the project is complete or ongoing. Identify the specific services provided, the periods for which such services were provided and information relative to this proposed activity. (Use a separate sheet).

4.6 **Technical Proposal:** Submit Proposal complying with Article "2" and "8" (Exhibit 3 – Design Criteria).

4.7 **Public Entity Crimes Statement:** Executed form attached hereto as Form "6".

4.8 **Project Schedule:** Provide a time schedule, which shall include design, permitting and construction time, with pertinent milestones, and start-up time.

- 4.9 **Project Organization and Management:** Identify the key personnel on the Proposer's project team, and their specific areas of expertise and responsibility. Provide a brief biographical sketch or resume of their professional qualifications and experience, including educational and licensing information.
- 4.10 **Project Cost Proposal:** Provide Project Cost Proposal in a clearly marked, separate, sealed envelope from the Technical Proposals, including specific costs for the following.
- 4.10.1 Design and construction price or total Project cost for the Work.
- 4.10.2 The Proposer will provide sufficient detail and breakdown of costs in a Schedule of Values to support their Project Cost Proposal.
- 4.10.3 All Project Cost Proposals are to include applicable local and state sales tax.
- 4.10.4 The Project Cost Proposal shall include a Guaranteed Maximum Price for the completion of the Work.
- 4.11 **Proposal Security.**
- 4.11.1 Each Proposal shall be accompanied by Proposal Security in the amount of five percent (5%) of the Project Cost Proposal.
- 4.11.2 Proposal Securities, if other than Bonds, will be returned to unsuccessful Proposers within fifteen (15) days following notice of the rejection of Proposals and that of the Design/Builder(s) shall be returned upon the execution of the Design/Build Agreement and delivery of all requirements for commencement of the Work, including bonds and insurance.
- 4.11.3 Should the Proposer selected by the Town Commission as the Design/Builder make any material misrepresentations or false statements in its Proposal, the amount of the Proposal Security shall be forfeited to the Town as liquidated damages, and not as a penalty.
- 4.12 **Insurance:** Proposer shall submit evidence of insurability from their insurance carrier for such types and minimum amounts of insurance as follows.
1. Workers' Compensation Insurance – Statutory limits and Employer's Liability Insurance - \$1,000,000
 2. Professional Liability (Errors and Omissions) Insurance –
 - \$1,000,000 per occurrence, \$2,000,000 aggregate on dedicated project limits with a deductible (if applicable) not to exceed \$25,000.00 per claim (audited financial statements required). The certificate of insurance shall reference any applicable deductible.

- Claims made on the policy must have an extended coverage reporting period of two (2) years past the coverage completion date.
 - For Deductible programs or Self Insured Retention programs an Irrevocable Letter of Credit or performance Bond for amount of SIR/Deductible is required.
3. Commercial General Liability Insurance – preferably written on an occurrence form with \$1,000,000 for each occurrence, to include contractual liability, personal & advertising injury, and products/completed operations, combined single limit for Bodily Injury Liability and Property Damage Liability, in the amount of Two Million Dollars (\$2,000,000) aggregate. .
 4. Automobile Liability Insurance – \$1,000,000 combined single limit bodily injury & property damage.

The successful Proposer must submit, prior to signing of the Design/Build Agreement, among other things, a Certificate of Insurance including the Town as an additional insured for Commercial General Liability and Auto Liability Insurance. The Successful Proposer shall guarantee all required insurance remain current and in effect throughout the term of Design/Build Agreement.

- 4.13 Performance Bonds and Payment Bonds shall be issued by approved bonding companies, to be acceptable to the Town, will be limited to those authorized to transact business in the State of Florida, having a resident agent in the State of Florida, and meeting the following requirements and/or limits: Surety shall be rated “B” or better as to the strength by Best’s Insurance Guide or Surety shall be listed on the U.S. Treasury Department’s list of acceptable sureties for federal bonds or bonding limits shall not exceed 20% of its policy surplus (capital & surplus) as listed in Best’s Insurance Guide; and, Surety shall have been in business and have a record of successful and continuous operation for at least five (5) years; and, all bonds shall contain all provisions required by Section 255.05, Florida Statutes. Said Bonds shall guarantee the performance of the Agreement and as security for the payment of all persons performing labor and furnishing materials in connection with the Agreement. The Performance Bond and Payment Bond shall be issued by the Surety Company on the forms provided within the Proposal Documents. No other forms will be acceptable. These forms are as follows.

4.13.1 **Design/Builder’s Performance Bond:** Required in the amount of one hundred percent (100%) of the Guaranteed Maximum Price.

4.13.2 **Design/Builder’s Payment Bond:** Required in the amount of one hundred percent (100%) of the Guaranteed Maximum Price.

4.14 **The Project Cost Proposal:**

- 4.14.1 Shall list each item of Work including design services and construction work for which payment will be made. A schedule of values for construction shall be included with the Project Cost Proposal to facilitate payment based on Work completed to date. No payment will be made for any items other than those listed in the Project Cost Proposal.
- 4.14.2 Required items of Work and incidentals necessary for the satisfactory completion of the Project which are not specifically listed in the Project Cost Proposal or included in one of the items list in the Project Cost Proposal shall be considered as incidental to the Project. All costs thereof, including the Proposer's overhead costs and profit, shall be considered as included in the schedule of values for the Project Cost Proposal.
- 4.14.3 Project Work includes furnishing all labor, equipment, tools and materials and performing all operations required to design, build, implementation and operation of the Community Center photovoltaic system.

ARTICLE 5
PROCEDURE AND CRITERIA FOR EVALUATING PROPOSALS

5.1 The Town will utilize a Selection Committee appointed by the Town Manager that will score and assign points during the evaluation and recommendation process. The Selection Committee will initially review the Technical Proposals to determine responsiveness and reject any Proposals deemed non-responsive. The Selection Committee will review and evaluate the responsive Technical Proposals and shall evaluate each of the Proposals based on all information required and submitted. After the Technical Proposals are evaluated, the Cost Proposals will be opened and evaluated. Proposals will be scored. The Selection Committee will place and rank not less than three (3) Proposers, provided that at least three (3) responsive Proposals have been received, on a list, which will become the Short Listed Firms. If less than three (3) Proposers submit Proposals, then the number of responsive Proposals received shall become the Short Listed Firms. The Town Manager shall submit the Short Listed Firms to the Town Commission with recommendation(s) for selection. The Town Commission shall review the Short Listed Firms' rankings and recommendations, and may require the Short Listed Firms to prepare oral presentations to the Town Commission. The Town Commission will then direct staff to negotiate a Design/Build Agreement with the selected proposer. The Town Commission may award the Design/Build Agreement from the Short Listed Firms as it determines to be in the best interest of the Town and most advantageous. Alternatively, the Town Commission may reject any or all Proposals or cancel this solicitation.

5.2 The Proposer shall present a comprehensive project plan for completing the Work. The plan shall address all significant design, construction and maintenance issues and constraints and shall demonstrate efficient use of manpower, materials, equipment, construction schemes, and techniques for completing the Project.

The minimum information to be included is as follows: Anticipated Award Date, Design Schedule, Design Reviews by the Town, Permitting, Start of Construction, Construction Milestones, Construction Phasing and Methods, conditional acceptance for all Work including punch list items, and final acceptance/completion date.

5.3 The Selection Committee shall review and evaluate the Proposals using the evaluation criteria. The Selection Committee, during its evaluation process, reserves the right to contact references and to verify information submitted by any Proposer. The Selection Committee may also request clarification or information from the Proposers. The evaluation and point assessment for each proposal shall be based on the following criteria for a maximum total of 100 points.

- 5.3.1 Firm Qualifications/Project Experience: **20 points**
- Relative financial strength of Proposer.
 - Ability to secure maintenance, performance and payment bonds.
 - Proposer’s experience and past performances in providing proposed design/build services, including demonstrating relevant design and construction experience, existing and past projects.
 - Reference verification.
 - Familiarity with local conditions.
- 5.3.2 Project Team and Team Experience **15 points**
- Qualifications and experience of Proposer Team, proposed key personnel, particularly project director and project manager, and subcontractors.
 - Quality and sufficiency of proposed staffing plan and organization structure.
- 5.3.3 Technical Approach; Implementation Schedule **30 points**
- Adequacy of Proposer’s approach to designing and constructing the Project, and understanding of the Project.
 - Proposed plan for the implementation and completion of the Project.
 - Project schedule.
 - Conceptual design plan.
- 5.3.4 Project Cost Proposal and Effectiveness **35 points**
- Basic Cost of Work for Design Services.
 - Basic Cost of Work for Construction.
 - Guaranteed Maximum Price.

TOTAL POSSIBLE POINTS: 100

ARTICLE 6
EXECUTION OF AGREEMENT AND COMPLETION OF WORK

- 6.1 The Design/Build Agreement will be prepared by the Town and provided to the selected Design/Builder. The Design/Builder shall, within 14 days of receipt of the Design/Build Agreement execute the Agreement and furnish any bonds and provide certificates of insurance as are required at the time of the execution of the Agreement.

The Town will enter into a negotiated Design/Build Agreement with the successful Proposer for a Guaranteed Maximum Price for the Work. The terms and conditions of the Design-Build Agreement are fixed price and fixed time. The Design/Builder's submitted Proposal is to be a guaranteed lump sum for completing the Work in this RFP. The Design/Builder will provide a Schedule of Values to the Town for their approval. The total of the Schedule of Values will be the lump-sum guaranteed price for the Work. The Design/Build will contain provisions common to design-build agreements for public improvements, including, but not limited to a design process with schematic, design development and construction drawing phases and 30/60/90% review of plans and specifications. The form of the Design/Build Agreement will be available to all proposers in advance of the Submission Deadline on the Town's website www.townofsurfsidefl.gov or via Addenda to this RFP.

- 6.2 Upon Town Commission approval, the Design/Builder shall, within fourteen (14) Days after receipt of Design/Build Agreement from the Town, 1) execute the Design/Build Agreement between Town and Design/Builder, 2) furnish any Bonds, and provide Certificates of Insurance required to be furnished at the time of execution of the Design/Build Agreement.
- 6.3 Should the Design/Builder fail to comply with the requirements of this Article within the specified time period, the Design/Builder's entire Proposal Security may be forfeited to the Town as liquidated damages by reason of Design/Builder's failure to timely execute and deliver same.
- 6.4 Work will be initiated on the basis of a Notice to Proceed and for any such Work so initiated, and a Payment Bond and Performance Bond shall be required.
- 6.5 The Proposer acknowledges the required security of a Proposal Bond or Cashier's Check.

ARTICLE 7
GENERAL INFORMATION AND ADMINISTRATIVE REQUIREMENTS

- 7.1 **Costs Incurred by Proposers:** All costs incurred by Proposers, their employees and agents, in preparing a response to this RFP, in clarifying such response to the satisfaction of the Town, in attending any pre-Proposal meetings, or in ascertaining the conditions of the site shall be the sole responsibility of the Proposers and will not be paid or reimbursed by the Town. The Proposer is further responsible for all legal expenses incurred by the Proposer for the Project, including contract review and negotiations. The Proposer's legal costs shall not be included in the Proposer's Proposal or factored into the Proposer's Project Cost Proposal. The Town shall not reimburse the Proposer for legal costs of any kind.
- 7.2 **Rejection of Proposals:** The Town reserves the right to reject any or all Proposals. Proposals not conforming to these instructions may be disqualified.
- 7.3 **Non-Binding Interpretations:** No verbal or written information, which is obtained other than by information in this RFP or written Addendum to this RFP, shall be binding on the Town.
- 7.4 **Withdrawal of Proposals:** A Proposal may not be withdrawn before the expiration of one hundred twenty (120) days from the date of Proposal opening. Proposals may be withdrawn if the Town fails to accept the Proposal within one hundred twenty (120) calendar days after the date fixed for opening Proposals.
- 7.5 **Public Records Laws:** Proposer acknowledges that except for specific statutory exceptions listed in Chapter 119, Florida Statutes, all information contained within their Proposal shall be considered a Public Record.
- 7.6 **Conflict of Interest:**
- 7.6.1 The award of this RFP is subject to the provisions of Chapter 112, Florida Statutes. All Proposers must disclose with their Proposal the name of any officer, director, or agent who is also an employee of the Town.
- 7.6.2 All Proposers must disclose the name of any Town employee, consultant or agent who owns, directly or indirectly, an interest of five percent (5%) or more of the Proposer's firm or any of its branches.

**ARTICLE 8
DESIGN CRITERIA PACKAGE**

- 8.1 **Design-Build Criteria:** The Town’s Design Criteria Professional prepared the Design Criteria Package for the design and construction of this Project. The purpose of the Design Criteria shall be to furnish design-build firms with sufficient information to allow the firms to prepare a response to the Town’s RFP. The design criteria includes, but is not limited to the following.
- 8.2 **Permitting:** Design/Builder shall, on behalf of the Town, apply for and obtain all permits, licenses and government approvals necessary for the design, construction and operations of the Project. All permit fees and associated costs for pursuing and obtaining required approvals and permits for the Work shall be the responsibility of the Proposer and shall be included in the Proposer’s Cost Proposal submitted in response to this RFP.
- 8.3 The Proposer’s approach to minimizing the impact of construction on the residential and commercial properties located within the Project area shall be described in detail.
- 8.4 Design and Construction Considerations and Requirements:
- 8.4.1 Proposer should be aware of all subsurface conditions.
- 8.4.2 The Town is subject to hurricanes and storms and therefore the Design/Builder shall consider such likelihood in their scheduling and construction activities.
- 8.4.3 It shall be the sole responsibility of the Design/Builder to secure any necessary temporary site or sites for use as staging areas for materials and equipment storage, temporary parking, and to accommodate any other logistical needs.
- 8.4.4 It shall be the Design/Builder’s sole responsibility to secure, store and dispose of all excess soil, drilling mud and any other construction spoils. The Town will not provide an area for storage or disposal of construction-related debris, nor will the Town provide labor or equipment to assist with such disposal.
- 8.4.5 **Special Concerns:** The special concerns included herein have been identified by the Town as particularly important to the citizens of Surfside. The special concerns include pedestrian traffic control, traffic mitigation, noise abatement, a minimal disruption to surrounding property owners and businesses. Proposers shall provide the Town with a plan and assurances to address all special concerns, including noise abatement.

EXHIBIT 1 – DESIGN CRITERIA PACKAGE

**LOCATION MAP OF COMMUNITY CENTER
(9301 Collins Avenue, Surfside, Florida 333154)**

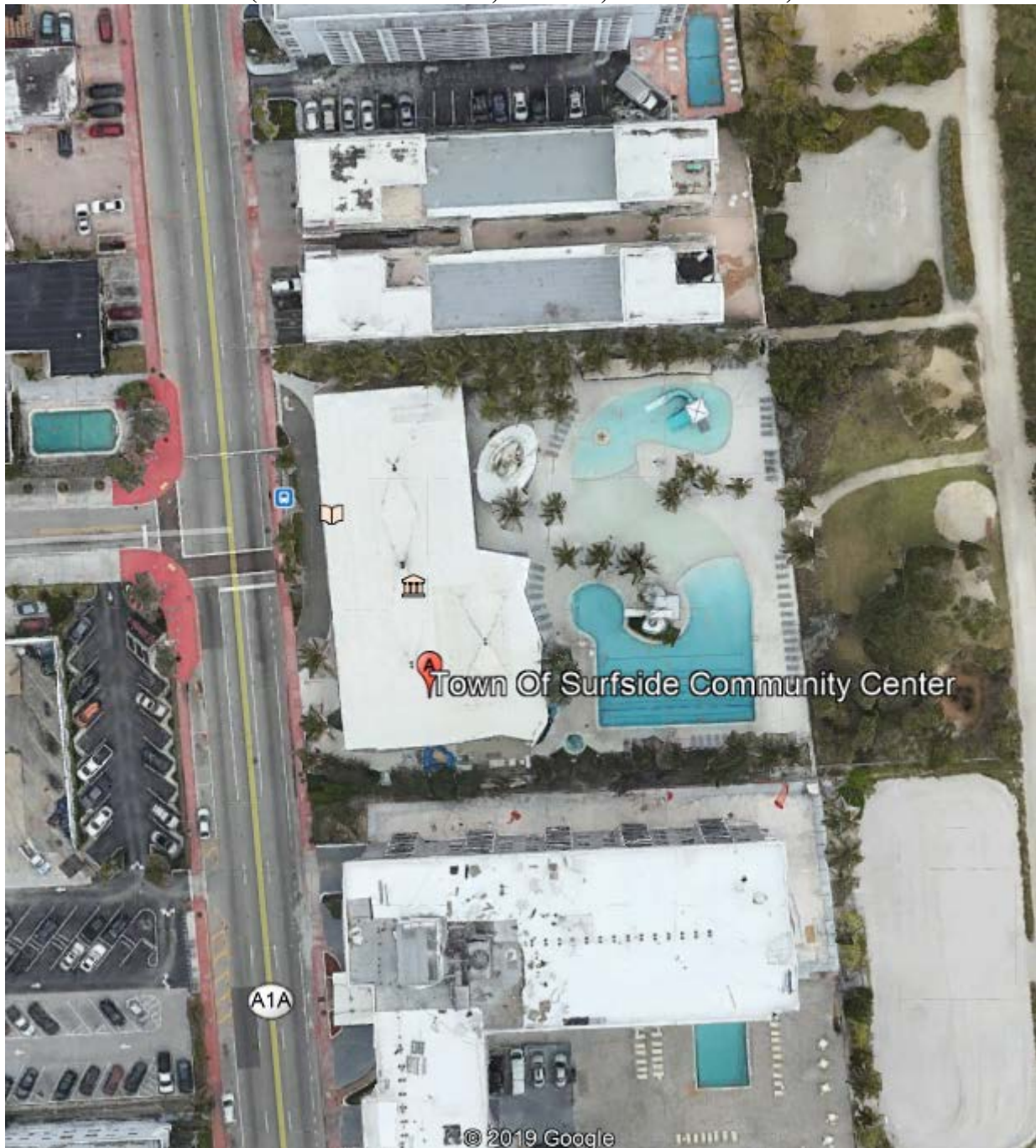

EXHIBIT 2 – DESIGN CRITERIA PACKAGE

**DESIGN CRITERIA PLANS
(EXHIBIT A THRU E)**

EXHIBIT 3 – RESENT FPL BILL

1 / 27 319870 8420052992931718874750000



TOWN OF SURFSIDE
9293 HARDING AVE
SURFSIDE FL 33154-3000

Nov 27, 2019 Electric Bill

For: Oct 29, 2019 to Nov 27, 2019 (29 days)

Service Address
9301 COLLINS AVE
SURFSIDE, FL 33154
VAGRAMONTE@TOWNOFSURFSIDEFL.GOV
Account Number 05299-29317

Questions? Contact Us
Reliable energy is affordable energy.
Learn how we save you money at fpl.com/savings

TOWN OF SURFSIDE:
Here's what you owe for this billing period.

Amount of your last bill	\$3,198.70
New charges due by Dec 18, 2019	\$2,549.18
Total amount you owe	\$5,747.88

Amount of your last bill	3,198.70
Balance before new charges	\$3,198.70
NEW CHARGES	
Rate: GSD-1 GENERAL SERVICE DEMAND	
Customer charge:	\$26.32
Non-fuel: (\$0.023490 per kWh)	\$668.05
Fuel: (\$0.025630 per kWh)	\$728.92
Demand: (\$11.24 per KW)	\$932.92
Electric service amount	2,356.21
Storm charge	-13.94
Gross receipts tax	60.06
Franchise charge	146.85
Taxes and charges	192.97
Total new charges	\$2,549.18
Total amount you owe	\$5,747.88

Meter Summary

Meter reading - Meter KV58395 Next meter reading Dec 30, 2019
Current reading 26949
Previous reading -26712

kWh constant	x 120
kWh used	28440
Demand reading	.69
KW constant	x 120.00
Demand KW	83

Energy Usage Comparison

	This Month	Last Month	Last Year
Service to	Nov 27, 2019	Oct 29, 2019	Nov 29, 2018
kWh Used	28440	37560	31080
Service days	29	32	31
kWh/day	980	1173	1002
Amount	\$2,549.18	\$3,198.70	\$2,704.28

Energy Usage History

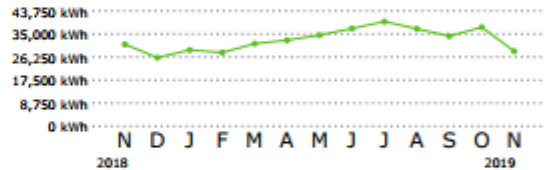

Keep In Mind

- Payment received after February 20, 2020 is considered LATE; a late payment charge of 1% will apply.
- The number of days included in your bill can vary month to month. So even if you use the same amount of energy per day, your bill may be higher next month due to greater number of service days. Visit www.FPL.com for more information.
- The Florida Public Service Commission approved a one-time refund related to the storm charge that is included in your November bill. Learn more: FPL.com/rates

Don't fall for a scammer

Scammers use caller ID spoofing appearing to be FPL. Don't fall for it when they demand payment with a prepaid card.
[Protect yourself](#)

Let's go solar, together

With FPL SolarTogether, a new proposed program, everyone has the opportunity to enjoy the benefits of solar.
[Learn More](#)

Useful Links
[Billing and service details](#)
[Energy News](#)
[View back of the bill](#)

Important Numbers

Customer Service: (305) 442-0388
Outside Florida: 1-800-226-3545
To report power outages: 1-800-4OUTAGE (468-8243)
Hearing/speech impaired: 711 (Relay Service)

**ARTICLE 9
PROPOSER'S ACKNOWLEDGEMENTS**

- 9.1 By submission of this Proposal, the Proposer acknowledges that he/she has thoroughly examined all plans, specifications, Proposal and Contract Documents; thoroughly familiarized himself with all existing site conditions; that no allowances shall be made by the Town for the Proposer's failure to do same; the Proposer offers to enter into a Design/Build Agreement with the Town to furnish Design/Services as well as all labor, materials and equipment to perform all Work included in and in accordance with the plans, Design Criteria Package, RFP and Contract Documents.
- 9.2 If the Proposer makes false statements or provides false information in any portion of the Proposal documents, the Proposer acknowledges that Proposer will be disqualified.
- 9.3 The Proposer understands and agrees with the form of this RFP as presented, absent any inadvertent drafting or technical errors, and agrees to not attempt to negotiate the terms and conditions of this Project, except as provided herein

**ARTICLE 10
REPRESENTATIONS**

- 10.1 Town is expressly relying upon the Proposer's representations for awarding this Project. Therefore, the Proposer unequivocally represents that the statements and information provided in response to this RFP are truthful.
- 10.2 The Proposer and all persons signing on behalf of the proposing person or entity, has the legal authority to bind the Proposer to the terms and conditions of this Project.
- 10.3 There are no legal impediments, conditions or orders, which would preclude the Proposer from satisfactorily performing the Proposer's duties as outlined in the RFP documents.

END OF INSTRUCTIONS

FORM “1”

PROPOSAL CHECKLIST

As provided in the RFP, the following items must be attached to this Proposal:

ITEMS	STATUS
Transmittal Letter	
TECHNICAL PROPOSAL	
Proposal Cover Sheet (Form 2)	
Proposer’s Statement of Qualifications (Form 5)	
Subcontractor Information (Form 5, Supplemental)	
Material/Equipment Suppliers Information (Form 5, Supplemental)	
References (Form 9)	
Statement on Public Entity Crimes (Form 6)	
Evidence of Insurability	
Project Organization and Management	
Staffing Plan	
Project Schedule	
Non-Collusion Affidavit (Form 7)	
Non-Discrimination Affidavit (Form 8)	
Project Cost Proposal (separate sealed package) (Form 3)	
Schedule of Values	
Proposal Security (Form 4)	

FORM "2"

PROPOSAL COVER SHEET

PROJECT: COMMUNITY CENTER PHOTOVOLTAIC SYSTEM

BID/PROJECT NO: RFP No. 2020-01

COMMENCEMENT: UPON TOWN'S ISSUANCE OF
"NOTICE TO PROCEED"

SUBSTANTIAL COMPLETION: _____ DAYS FROM "NOTICE TO PROCEED"

PROPOSAL BOND: _____

Made as of the _____ day of _____, 20____.

PROPOSER: _____

ADDRESS: _____

PHONE: _____

FAX: _____

ORGANIZATION
TYPE:

_____ INDIVIDUAL

_____ PARTNERSHIP

_____ CORPORATION

_____ OTHER (explain)

ACKNOWLEDGMENT OF ADDENDUM

The Proposer hereby acknowledges the receipt of the following addenda issued by the Town and/or Consultant and incorporated into and made part of the Design/Build Agreement and Contract Documents for this Project.

Addendum No. _____ **Date** _____

Addendum No. _____ **Date** _____

Addendum No. _____ **Date** _____

Addendum No. _____ **Date** _____

Addendum No. _____ **Date** _____

Addendum No. _____ **Date** _____

Addendum No. _____ **Date** _____

Addendum No. _____ **Date** _____

Addendum No. _____ **Date** _____

Addendum No. _____ **Date** _____

Signature **Title**

ACKNOWLEDGMENT AND SEAL

Firm Name

Signature

Title

Witness

Name

Witness

Name

Corporate Seal:

Incorporated under the laws of the State of _____ .

FORM "3"

**PROJECT COST PROPOSAL
(GUARANTEED MAXIMUM PRICE)**

Project Title: TOWN OF SURFSIDE - COMMUNITY CENTER PHOTOVOLTAIC SYSTEM

Payment for the various items of the Project Cost Proposal shall include all compensation for design and engineering services, construction, furnishing tools, equipment, supplies, and manufactured articles, labor operations, permit fees, licenses, taxes, insurances, bonds, overhead and profit, and incidentals appurtenances thereto, and including all costs of compliance with the regulations of public agencies having jurisdiction, including but not limited to the Occupational Safety and Health Administration of the US Department of Labor (OSHA), FDOT, Miami-Dade County and the Town. No separate payment will be made for any item that is not specifically set forth in the cost proposal, and all costs therefore shall be included in the prices provided below.

PROJECT COST PROPOSAL

		Lump Sum / Guaranteed Maximum Price
	Design cost: _____ Construction cost: _____	Total Project Cost Proposal: \$ _____ (Numerical) _____ Dollars (Written)

SUBMITTED BY

Organization

Signature

Signature of Witness

Name Title

Signature of Witness

Name Title

Date

END OF PROJECT COST PROPOSAL

FORM "4"

PROPOSAL SECURITY FORM

_____	_____
Name	Name
_____	_____
Address	Address
FLORIDA RESIDENT AGENT	TOWN OF SURFSIDE
Name:	9293 HARDING AVENUE
Address:	SURFSIDE, FLORIDA 33154
Telephone:	Telephone: 305-861-4863
Fax:	Fax: 305-861-1302
PROJECT:	
_____	_____
Proposal Due Date	Bond Number
_____	\$ _____
Bond Date	Penal Sum

[ACKNOWLEDGMENTS ON FOLLOWING PAGE]

IN WITNESS WHEREOF, Surety and Proposer, intending to be legally bound hereby, subject to the terms included in this section, do each cause this Proposal Bond to be duly executed on its behalf by its authorized officer, agent, or representative.

PROPOSER

**SURETY
(Attach Power of Attorney)**

Corporate Name and Seal

Corporate Name and Seal

Signature

Signature

Name and Title

Name and Title

Attest

Attest

Attest

Attest

Note: Above addresses shall be used for giving of required notices. Any singular reference to Proposer, Surety, Florida Resident Agent, Town or other party shall be considered a plural where applicable.

1. Proposer and Surety, upon default of Proposer, jointly and severally, bind themselves, and their heirs, executors, administrators, successors and assigns to pay to Town upon default of Proposer the penal sum set forth on the face of this Bond.
2. Default of Proposer shall occur upon the failure of Proposer to deliver within the time required by the bidding documents (or any extension thereof granted in writing by Town) the executed Design Build Agreement and the Bonds and Certificates of Insurance required to be furnished at the time of execution of the Design Build Agreement.
3. This obligation shall be null and void if:
 - A. Town accepts Proposer’s Proposal and Proposer timely complies with the requirements of Section 2 of this Bond, or
 - B. All Proposals are rejected by Town , or
 - C. Town fails to issue a notice of award to Proposer within the time specified in the bidding documents (or any extension thereof granted in writing by Proposer and, if applicable, consented to be Surety when required by paragraph 5 hereof).

4. Payment under this Bond will be due and payable upon default by Proposer and within 30 calendar days after receipt by Proposer and Surety of written notice of default from Town, which notice will be given with reasonable promptness, identifying this Bond and the Project and including a statement of the amount due.
5. Surety waives notice of any and all defenses based on or arising out of any time extension to issue notice of award agreed to in writing by Town and Proposer, provided that the total time for issuing Notice of Award including extensions shall not in the aggregate exceed 120 days from bid due date without Surety's written consent.
6. No suit or action shall be commenced under this Bond prior to 30 calendar days after the notice of default required in paragraph 4 above is received by Proposer and Surety and in no case later than one (1) year after bid due date.
7. Any suit or action under this Bond shall be commenced only in a Monroe County, Florida court of competent jurisdiction. Any award granted shall not be subject to prejudgment interest.
8. Notices required hereunder shall be in writing and sent to Proposer and Surety at their respective addresses shown on the face of this Bond. Such notices may be sent by personal delivery, commercial courier or by United States Registered or Certified Mail, return receipt requested, postage pre-paid, and shall be deemed effective upon receipt by the party concerned.
9. Surety shall cause to be attached to this Bond a current and effective Power of Attorney evidencing the authority of the officer, agent or representative who executed this Bond on behalf of Surety to execute, seal and deliver such Bond and bind the Surety thereby.
10. This Bond is intended to conform to all applicable statutory requirements. Any applicable requirement of any applicable statute that has been omitted from this Bond shall be deemed to be included herein as if set forth at length. If any provision of this Bond conflicts with any applicable statute, then the provision of said statute shall govern and the remainder of this Bond that is not in conflict therewith shall continue in full force and effect.
11. The term "bid" as used herein includes a bid, offer or Proposal as applicable.

END OF PROPOSAL BOND

FORM "5"

STATEMENT OF PROPOSER'S QUALIFICATIONS

The Proposer, as well as any Subcontractors who will perform at least 20% of either the design or the construction phases of this Project, must be included in this Statement of Qualifications. Information provided on this document and its attachments will be subjectively evaluated by the Evaluation Committee. For purposes of completing this Statement of Qualifications, "Firm" means the Proposer. Design/Build Team means the Proposer and the Subcontractors who will perform at least 20% of either the design or the construction phases of this Project.

Use additional sheets if necessary to fully document responses.

1. List the names of the Proposer's principals and their titles:

Firm Name

Principal & Title

Principal & Title

Address

City, State & Zip Code

Phone

Fax

2. Proposer is a:
 Sole Proprietorship Corporation Partnership Joint Venture
 Other (Explain):

3. Your Federal Employer Identification Number (FEIN) is:

(If applicable) (If the entity has no FEIN, include the Social Security Number of the individual signing this sworn statement)

4. License(s) and Registration(s):

(a) What is the Proposer's primary practice or professional service:

Contractor Architect Engineer Other (explain):

(Attach copies of registrations, licenses, certificates, and other documentation as issued by the State of Florida, Miami-Dade County, or other agency.)

(b) List the name(s) and title(s) of person(s) in your Firm who are authorized to enter into an Design/Build Agreement with the Town of Surfside for the proposed Work should your Firm be the Successful Proposer.

Name & Title

Name & Title

(c) List Principals and other key personnel licensed in the State of Florida:

Name

Registration Type

Years Registered

Years Employed
by Proposer

Name

Registration Type

Years Registered Years Employed
by Proposer

Name

Registration Type

Years Registered Years Employed
by Proposer

(Attach copies of registrations, licenses, certificates, and other documentation as issued by the State of Florida, Miami-Dade County, or other agency.)

(d) Remarks:

5. How long has your Firm been in business under its present name?
_____.

6. Design/Build Team Composition:

(a) List Team Members (Attach additional sheets as necessary):

Team Member Name

Principal

Discipline/Specialty

Location

Team Member Name

Principal

Discipline/Specialty

Location

- (b) Attach copies of registrations, licenses, certificates, and other documentation as issued by the State of Florida, Miami-Dade County, or other agency.

7. Financial Statements for Proposer:

- (a) Attach audited financial statements for the last three years, or, at a minimum, CPA-reviewed financial statement for the last three years.
- (b) List annual revenues (last three years) and annual net income (Loss) (last three years)

8. Past Experience:

- (a) The Proposer must demonstrate their specific design and construction experience in the United States as presented by their Team, including but not limited to design and construction/installation of photovoltaic systems or similar systems.
- (b) **References:** Detailed description of comparable contracts as they pertain to the Scope of Services similar to that requested in this RFP, which the Proposer and Subcontractor has either ongoing or completed within the past five (5) years. The description should identify for each project: (i) client, (ii) a complete description of work, (iii) total dollar value of the contract, (iv) dates covering the term of the contract, (v) client contact person and phone number, (vi) statement of whether Proposer was the prime contractor or subcontractor, and (vii) the results of the project. Where possible, list and describe those projects performed for government clients or similar size private entities (excluding any work performed for the Town of Surfside).

- (c) Has the Proposer ever failed to complete a bonded obligation? If yes, provide details including circumstances, where and when, name of bonding company, name and address of owner, and disposition of matter on an attachment to this Form.
 Yes No

- (d) Has the Proposer ever been declared non-responsive or defaulted on a previous contract? If yes, provide details including circumstances, identification of the project, and disposition or current status of the matter on an attachment to this Form.
 Yes No

- (e) Within the last five years, has the Proposer been involved in a legal matter against the Town of Surfside? If yes, provide details including circumstances, identification of the project, and disposition or current status of the matter on an attachment to this Form.
 Yes No

- (f) Within the last five years, has the Proposer been involved in a matter that was arbitrated against the Town of Surfside? If yes, provide details including circumstances, identification of the project, and disposition or current status of the matter on an attachment to this Form.
 Yes No

9. Current Workload:

- (a) List current projects (either in design or under construction) including contract amounts, the scope of the project in square feet of construction, the current status or projected date of completion, and notation of whether participation in the project was fully bonded or not. Attach additional sheets as necessary to portray your total current workload.

Project
Value
Square Feet
Status
Bonded

Project

Value

Square Feet

Status

Bonded

9. Attachments:

(a) **MANDATORY ATTACHMENTS:**

1. Copy of professional registration and/or Certificates of Authorization issued by the Florida Department of Business and Professional Regulation indicating your Team's qualifications as defined in Section 287.055, Florida Statutes.
2. Copies of professional licenses, registration, certifications, or certificates of competency issued by the Florida Department of Business and Professional Regulation or Miami-Dade County for the Proposer and Team Members.
3. Further Documentation or explanatory materials related to Items 6, 7 (g), 7 (h), and 8.
4. Visual examples of two (2) different projects representative of your Team's work and comparable to the scope of services set forth in this RFP, such as photos of completed buildings or models, reproductions of renderings, plans, drawings or other types of information sufficient to indicate the quality and character of your work. Each submittal must not be larger than 8-1/2 by 11 inches and should include the following information:
 - a. The original estimated construction cost.
 - b. Time duration from the start of design to completion of construction documents.
 - c. Actual cost of construction awarded or completed.

(b) **OPTIONAL ATTACHMENTS:** Attach any brochures, photographs, video or other documentation that may assist in the evaluation of your Team. A complete copy of any optional

attachment must be included with each of the required copies of your Proposal to receive consideration.

The undersigned guarantees the authenticity of the foregoing statements and does hereby authorize and request any person, team, or corporation to furnish any information requested by the Town of Surfside in verification of the recitals comprising this Statement of Proposer's Qualifications.

(c) Proposer's Representations:

1. The Proposer acknowledges that the Town of Surfside is relying upon the Proposer's statements and representations for determining the Proposer's qualifications. Therefore, any misrepresentations, misstatements, or fraudulent statements shall be used, at the Town of Surfside's sole discretion, as a basis for disqualifying the Proposer.
2. The Proposer unequivocally represents that the statements and information provided in response to this qualification statement are truthful.
3. The Proposer and all persons signing on behalf of the bidding person or entity, has the legal authority to bind the Proposer or entity to the statements and representations made in this document.

SUBMITTED BY

Signature of Proposer

Printed Name

Title

Name of Firm

Date

Signature of Witness

Printed Name

Title

Name of Firm

Signature of Witness

Printed Name

Title

Name of Firm

FROM “6”

**TOWN OF SURFSIDE
Sworn Statement under Section 287.133(3)(a),
Florida Statutes on Public Entity Crimes**

(This form must be signed in the presence of a notary public or other officer authorized to administer oaths.)

1. This sworn statement is submitted with the RFP Contract for Design/Build of the Town of Surfside’ s Community Center Photovoltaic System.
2. This sworn statement is submitted by:

(Name of entity submitting sworn statement)

whose business address is:

Federal Employer Identification Number (FEIN) is: _____
(if the entity has no FEIN, include the Social Security Number of the individual signing this sworn statement)

(If applicable)

Social Security Number: _____

3. My name is: _____
(Print name of individual signing)

and my relationship to the entity is: _____

4. I understand that a “public entity crime” as defined in Section 287.133(1)(g), Florida Statutes means a violation of any state or federal law by a person with respect to and directly related to the transaction of business with any public entity or with an agency or political subdivision of any other state or with the United States, including, but not limited to, any bid or contract for goods or services to be provided to any public entity or an agency or political subdivision of any other state or of the United States and involving antitrust, fraud, theft, bribery, collusion, racketeering, conspiracy, or material misrepresentation.
5. I understand that a “convicted” or “conviction” as defined in Paragraph 287.133(1)(b), Florida Statutes means a finding of guilt of a conviction of a public entity crime, with or without an adjudication of guilt, in any federal or state trial court of record relating to charges brought by indictment or information after July 1, 1989, as a result of a jury verdict, non-jury trial, or entry of a plea of guilty or nolo contendere.

6. I understand that an “affiliate” as defined in Section 287.133(1)(a), Florida Statutes means:

- (a) A predecessor or successor of a person or a corporation convicted of a public entity crime; or
- (b) An entity under the control of any natural person who is active in the management of the entity and who has been convicted of a public entity crime. The term “affiliate” includes those officers, directors, executives, partners, shareholders, employees, members, and agents who are active in the management of an affiliate. The ownership by one person of shares constituting a controlling interest in another person, or a pooling of equipment or income among persons when not for fair market value under an arm’s length agreement, shall be a prima facia case that one person controls another person. A person who knowingly enters into a joint venture with a person who has been convicted of a public entity crime in Florida during the preceding 36 months shall be considered an affiliate.

7. I understand that a “person” as defined in Section 287.133(1)(e), Florida Statutes, means any natural person or entity organized under the laws of any state or of the United States with the legal power to enter into a binding contract and which bids or applies to bid on contracts for the provision of goods or services let by a public entity, or which otherwise transacts or applies to transact business with a public entity. The term “person” includes those officers, directors, executives, partners, shareholders, employees, members, and agents who are active in management of an entity.

8. Based on the information and belief, the statement which I have marked below is true in relation to the entity submitting this sworn statement. (Please indicate which statement applies)

_____ Neither the entity submitting the sworn statement, nor any officers, directors, executives, partners, shareholders, employees, members or agents who are active in management of the entity nor any affiliate of the entity have been charged with and convicted of a public entity crime subsequent to July 1, 1989.

_____ The entity submitting this sworn statement, or one or more of the officers, directors, executives, partners, shareholders, employees, members or agents who are active in management of the entity or an affiliate of the entity has been charged with and convicted of a public entity crime subsequent to July 1, 1989 and (Please indicate which additional statement applies)

_____ There has been a proceeding concerning the conviction before a hearing officer of the State of Florida, Division of Administrative Hearings. The final order entered by the hearing officer did not place the person or affiliate on the convicted vendor list. (Please attach a copy of the final order)

_____ The person or affiliate was placed on the convicted list. There has been a subsequent proceeding before a hearing officer of the State of Florida, Division of Administrative Hearings. The final order entered by the hearing officer determined that it was in the public interest to remove the person or affiliate from the convicted vendor list. (Please attach a copy of the final order)

_____ The person or affiliate has not been placed on the convicted vendor list. (Please describe any action taken by or pending with the Department of General Services.)

I UNDERSTAND THAT THE SUBMISSION OF THIS FORM TO THE CONTRACTING OFFICER FOR THE PUBLIC ENTITY IDENTIFIED IN PARAGRAPH 1 ABOVE IS FOR THAT PUBLIC ENTITY ONLY AND, THAT THIS FORM IS VALID THROUGH DECEMBER 31 OF THE CALENDAR YEAR IN WHICH IT IS FILED.

I ALSO UNDERSTAND THAT I AM REQUIRED TO INFORM THE PUBLIC ENTITY PRIOR TO ENTERING INTO A CONTRACT IN EXCESS OF THE THRESHOLD AMOUNT PROVIDED IN SECTION 287.017, FLORIDA STATUTES, FOR CATEGORY TWO OF ANY CHANGE IN THE INFORMATION CONTAINED IN THIS FORM.

Signature: _____
Name: _____
Title: _____

STATE OF FLORIDA)
) ss:
COUNTY OF _____)

Sworn to and subscribed and acknowledged before me this ___ day of _____, 2020, by _____, as _____ (title) of _____ (Proposer/Company name), and on behalf of the corporation and who is personally known to me or has produced _____ as identification and who did take an oath.

[SEAL]

Notary Public, State of Florida

Print Name of Notary

Commission No. _____

Commission Expires: _____

FORM "9"
REFERENCES

The following is a list of at least three (3) references from municipalities for which Proposer provided similar services or comparable contracts to those sought in this RFP in the past five (5) years:

Name of Entity for which services were performed: _____
Brief Description of Scope of Services: _____
Amount of Contract Award: _____
Status of Contract: _____
Contact Name: _____
Telephone Number: _____

Name of Entity for which services were performed: _____
Brief Description of Scope of Services: _____
Amount of Contract Award: _____
Status of Contract: _____
Contact Name: _____
Telephone Number: _____

Name of Entity for which services were performed: _____
Brief Description of Scope of Services: _____
Amount of Contract Award: _____
Status of Contract: _____
Contact Name: _____
Telephone Number: _____

Name of Entity for which services were performed: _____
Brief Description of Scope of Services: _____
Amount of Contract Award: _____
Status of Contract: _____
Contact Name: _____
Telephone Number: _____

Name of Entity for which services were performed: _____
Brief Description of Scope of Services: _____
Amount of Contract Award: _____
Status of Contract: _____
Contact Name: _____
Telephone Number: _____



MEMORANDUM

ITEM NO. 4QQ

To: Honorable Mayor, Vice-Mayor and Members of the Town Commission
From: Guillermo Olmedillo, Town Manager
Date: 05/12/2020
Subject: Beachwalk Trimming

Background: The Town Commission directed staff to confirm that there are permits in place and to get quotes in order to trim the sea grapes along the Beachwalk.

Analysis Staff has contacted the Florida Department of Environmental Protection (FDEP) regarding permits. FDEP advised that no permit is required for the trimming of the sea grapes as long as some maintenance requirements are met. Three vendors have been contacted to receive quotes to trim the sea grapes along the Beachwalk.

Budget Impact: Unknown at this moment

Commission direction: Staff will bring back this item during the next Commission meeting with the different quotes in order for the Town Commission to decide.

Reviewed by

Prepared by



MEMORANDUM

ITEM NO. 4RR

To: Honorable Mayor, Vice-Mayor and Members of the Town Commission
From: Guillermo Olmedillo, Town Manager
Date: May 12, 2020
Subject: Community Center Pool Deck Lighting

The Parks and Recreation Department is looking into an engineering firm to assist in the feasibility and basic design criteria to install permanent pool deck lighting. This would include all Florida Building Code (FBC) and Town of Surfside Code of Ordinances covering turtle protection. Also, included in this would be the Florida Department of Environmental Protection (DEP) and Florida Fish and Wildlife Commission (FWC) guidelines.

The cost would include the preparation of an RFP, all permits required for the project and to oversee the construction and closeout of the project. Operational cost will also be included to cover additional staff, projected utilities and pool chemicals on an annual basis.

Per the request of the Town Commission, staff will have these costs available during the budget process for Fiscal Year 2021.

Reviewed by: TM

Prepared by: TM



MEMORANDUM

ITEM NO. 4SS

To: Honorable Mayor, Vice-Mayor and Members of the Town Commission
From: Guillermo Olmedillo, Town Manager
Date: May 12, 2020
Subject: Community Center Second Floor

The Town of Surfside Community Center was designed and constructed under the provisions of the Florida Building Code 3rd Edition (2007) including consideration for a second story according to the approved structural plans specifically sheet S3.0.02. An elevator pit and section of the roof structure not continuous or poured separately from the rest of the roof slab. This portion of the slab that was pinned in place to be removed at some future time to accommodate an elevator shaft. These two elements were left in the design and constructed accordingly to allow said future second story. This area is now known as "Fish Bowl". No other elements have been found on the approved plans or records. Nothing in the design and construction of the Community Center precludes a second story from being designed and built at some future date. Note the present code in-force is the Florida Building Code 6th Edition (2017). Aforementioned details taken from sheet S3.0.02 of the approved plans below.

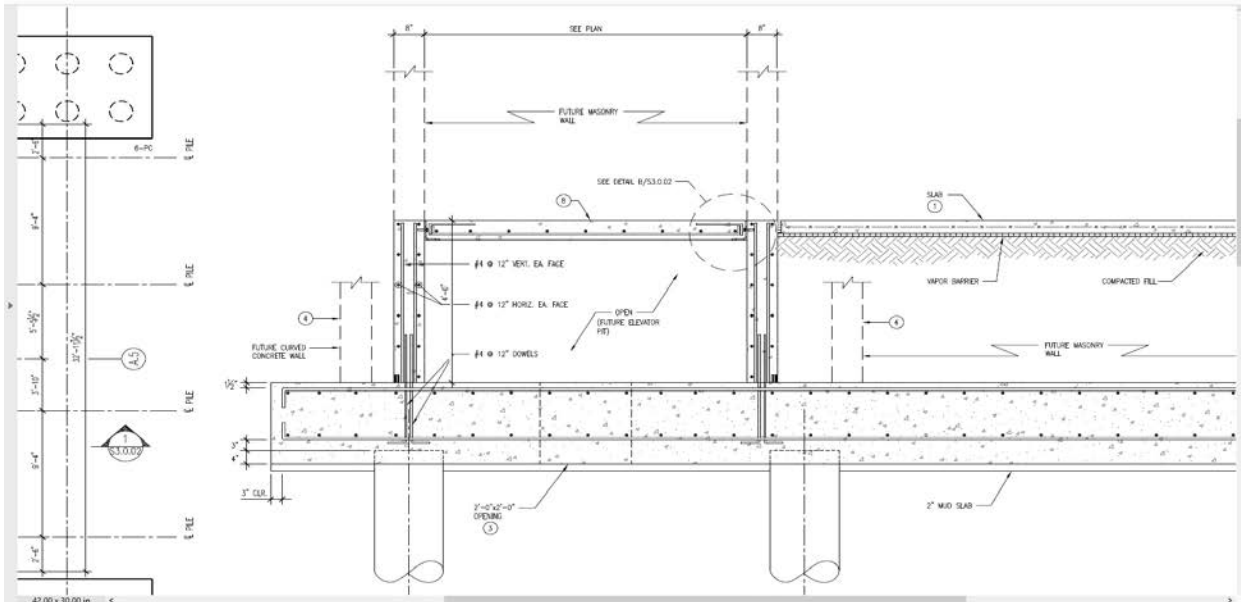

Reviewed by: MR/RP

Prepared by: MR/RP



Town of Surfside
9293 Harding Avenue
Surfside, FL 33154

**Government Structure
(As of April 24, 2020 - Includes Laid off Staff)**

Residents of Surfside

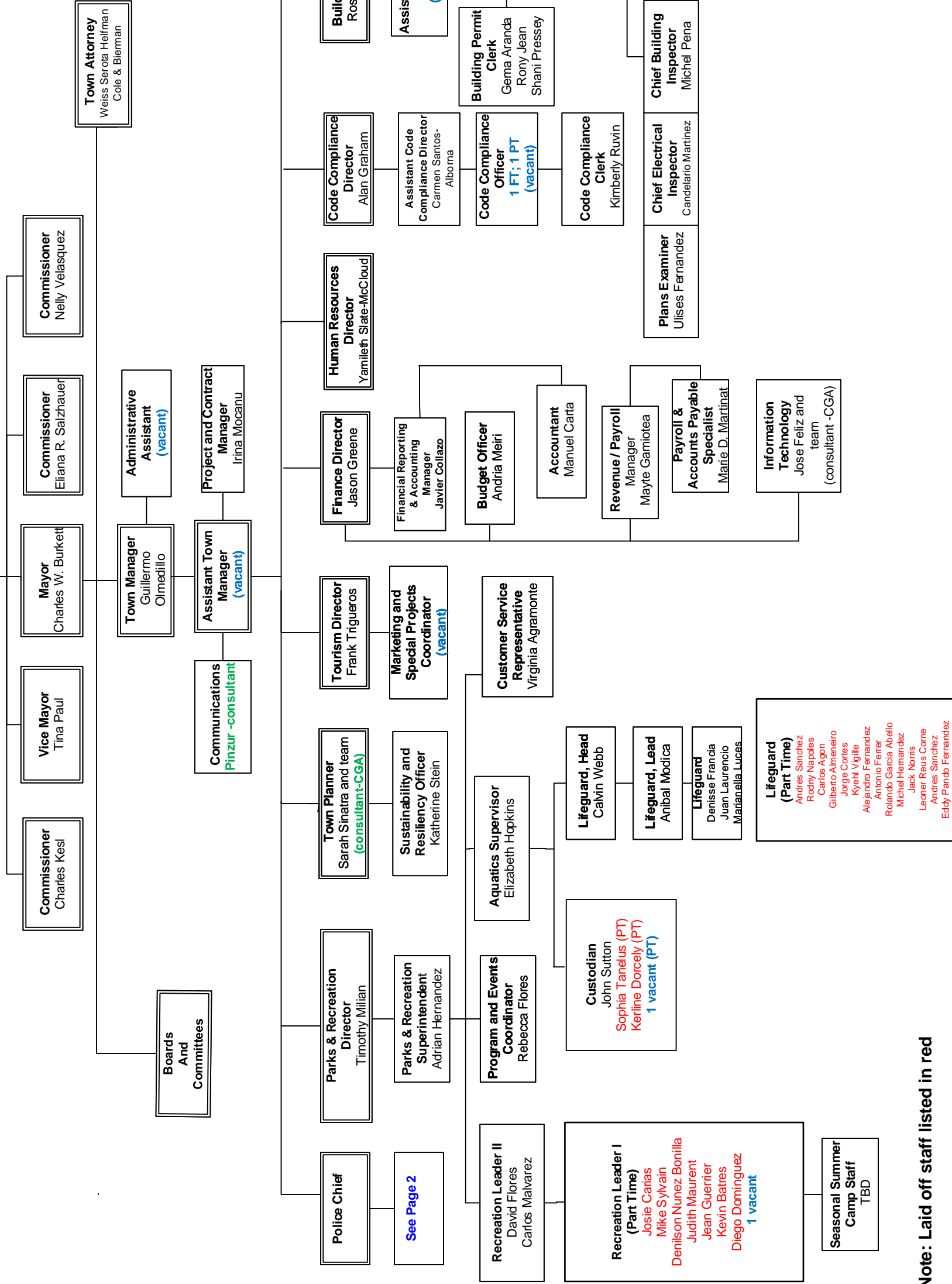

Note: Laid off staff listed in red



Town of Surfside
9293 Harding Avenue
Surfside, FL 33154
Government Structure
(As of April 24, 2020)

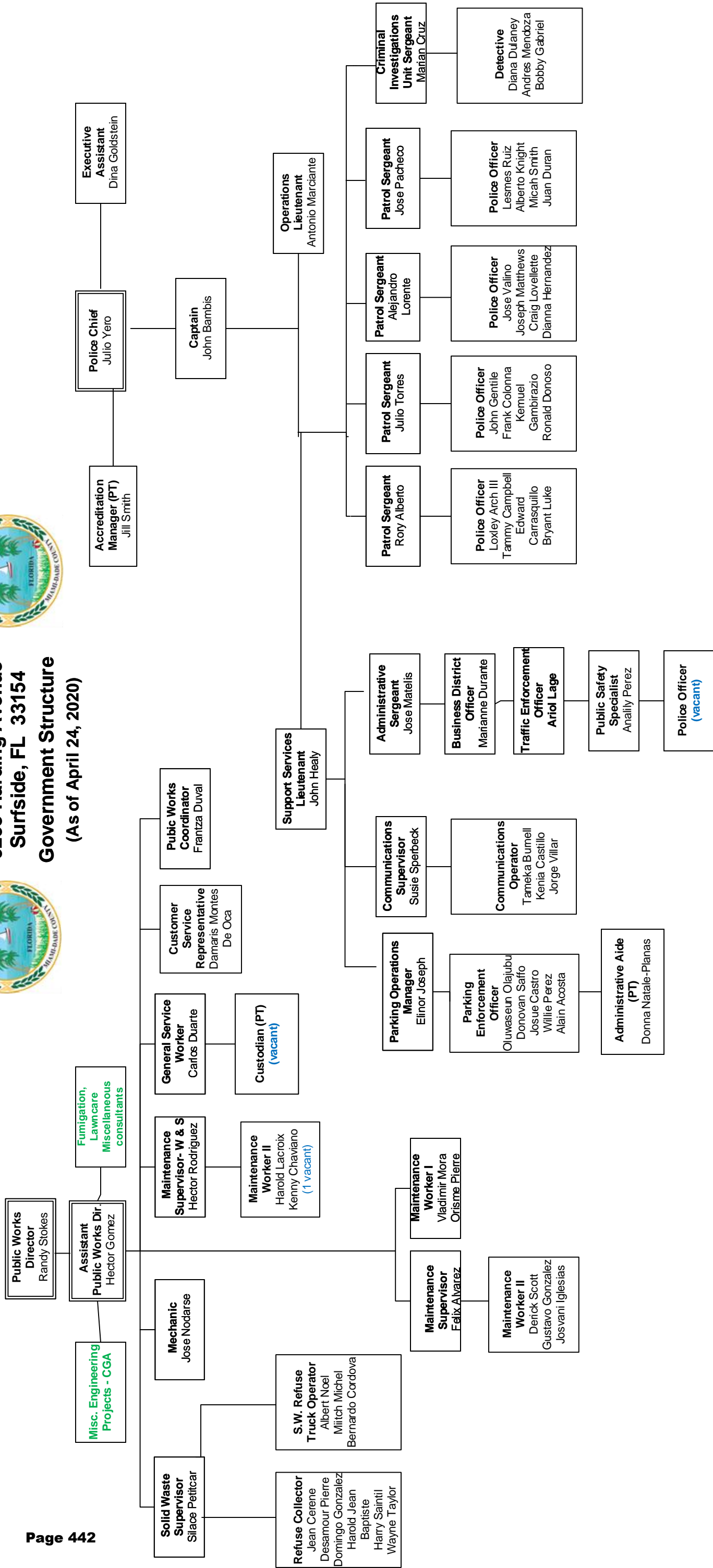

ORDINANCE NO. 17 – 11062

AN ORDINANCE OF THE TOWN COMMISSION OF THE TOWN OF SURFSIDE, FLORIDA AMENDING CHAPTER 86 “WATERWAYS”; ARTICLE II, “PUBLIC BEACHES”, SPECIFICALLY AMENDING SECTION 86-26 “DEFINITIONS”; SPECIFICALLY AMENDING SECTION 86-31 “BEACH FURNITURE PERMIT REQUIREMENTS”; SPECIFICALLY AMENDING SECTION 86-33 “VIOLATIONS, CIVIL FINES AND PENALTIES”; PROVIDING FOR INCLUSION IN THE CODE; REPEALING ALL ORDINANCES OR PARTS OF ORDINANCES IN CONFLICT HEREWITH; AND PROVIDING FOR AN EFFECTIVE DATE.

WHEREAS, the Town has the authority to promulgate laws to regulate the public beach in a reasonable manner to protect public health, safety, and welfare, which must have a rational relation and be reasonably designed to accomplish a purpose necessary for the protection of the public; and

WHEREAS, the Florida Constitution states that “The title to lands under navigable waters, within the boundaries of the state, which have not been alienated, including beaches below mean high water lines, is held by the state, by virtue of its sovereignty, in trust for all the people,” s.11, Art. X, Fla. Const; and

WHEREAS, on December 13, 2016 the Town Commission adopted Ordinance No. 16-1658 to regulate beach furniture and its corresponding *Administrative Policy: Beach Furniture and Equipment* which provides for public access and safety and requirements for beach furniture; and

WHEREAS, on April 13, 2017 the Town Commission directed Town Administration to amend the beach furniture ordinance to clarify terms in the ordinance; and

WHEREAS, the Town Commission held its first public hearing on May 9, 2017 and recommended approval of the proposed amendments to the Code of Ordinances having complied with the notice requirements by the Florida Statutes; and

WHEREAS, the Town Commission has conducted a second duly noticed public hearing on these regulations as required by law on June 13, 2017 and further finds the proposed change to the Code necessary and in the best interest of the community.

NOW, THEREFORE, BE IT ORDAINED BY THE TOWN COMMISSION OF THE TOWN OF SURFSIDE, FLORIDA:

Section 1. Recitals. The foregoing “WHEREAS” clauses are ratified and confirmed as being true and correct and are made a specific part of this Ordinance.

Section 2. Code Amendment. Article II, "Public Beaches," specifically Section 86-26 "Definitions," Section 86-31 "Beach Furniture Permit Requirements" and Section 86-33 "Violations, Civil Fines and Penalties" is hereby amended as follows:

Sec. 86-26. - Definitions.

* * *

Beach Furniture Operator is ~~a hotel located on the east side of Collins Avenue which uses or allows another party to use such beach furniture as part of a short term paid lodging authorized through a Certificate of Use issued by the Town.~~ a hotel or Condominium Association located on the east side of Collins Avenue that provides beach furniture services to its residents and guests or a hotel located on the west side of Collins Avenue so approved by the Town Commission pursuant to Section 86-31(B)(2) of the Town Code.

Beach Furniture Setup is the organized preplacement of beach furniture by a Beach Furniture Operator in anticipation of use by an individual Beach Furniture User.

Beach Furniture Storage is the overnight placement of beach furniture on the public beach.

Beach Furniture User is an individual using any item of beach furniture while on the public beach. This applies to the general public, condominium residents and hotel guests.

* * *

Sec. 86-31. - Beach Furniture Permit Requirements.

Beach Furniture Operator, as defined in this article must obtain a permit for Beach Furniture Setup and Beach Furniture Storage ~~to place beach furniture~~ on the public beach within the Town. Town Manager or designee shall establish an Administrative Policy: Beach Furniture and Equipment for the placement of beach furniture on the public beach ~~by Beach Furniture Operators for public safety, access and maintenance, as set forth by Administrative Policy.~~ A hotel Beach Furniture Operators must procure a local business tax receipt and comply with the regulations of Section 70-41 of the Town of Surfside Code and all required licenses or permits from Miami-Dade County, the State of Florida and federal entities.

Sections ~~86-26 86-31~~ to 86-33 herein shall be reviewed by the Town Commission within one year of after its enactment and the Town will notify any Beach Furniture Permit holder prior to any meeting of such review. Nothing in Sections 86-31 to 86-33 shall require a permit from the general public to place beach chairs and/or equipment on the beach for personal use on an as needed basis.

~~A.~~ Application. Any Beach Furniture Operator shall apply for a Beach Furniture ~~p~~Permit on a form prepared by the Town along with the applicable permit application fee. ~~All permit applications shall include the following:~~

- ~~(1) An application fee of \$500.00;~~

- ~~(2) An evacuation plan, in the event of a natural disaster such as a tropical storm or hurricane, including a storage area.~~
- ~~(3) Beach furniture operations plan, including specifications on storage, staffing and clean-up.~~
- ~~(4) Compliance with indemnification and insurance requirements pursuant to Section 86-32 of the Town of Surfside Code.~~

A. Beach Furniture Permit applications for hotels or Condominium Association located on the east side of Collins Avenue shall include the following:

- (1) An application fee of \$500.00;
- (2) Beach Furniture Operations Plan, including specifications on setup, storage, staffing and clean-up, and an evacuation plan, in the event of a natural disaster such as a tropical storm or hurricane, specifying a storage area during the natural disaster.
- (3) Compliance with indemnification and insurance requirements pursuant to Section 86-32 of the Town of Surfside Code.

B. Beach Furniture Permit applications for hotels located on the west side of Collins Avenue must be approved by the Town Commission.

- (1) Beach Furniture Permit applications for hotels located on the west side of Collins Avenue shall include the following:
 - a. An application fee of \$500.00;
 - b. Beach Furniture Operations Plan, including specifications on storage, staffing and clean-up, and an evacuation plan, in the event of a natural disaster such as a tropical storm or hurricane, including a storage area;
 - c. Compliance with indemnification and insurance requirements pursuant to Section 86-32 of the Town of Surfside Code;
- (2) All applications for hotels located on the west side of Collins Avenue are subject to the Town Administrative Policy: Beach Furniture and Equipment and shall be approved by the Town Commission.
 - a. The Town Commission shall review each application for conformity with the Town Administrative Policy: Beach Furniture and Equipment and decide whether the application shall be approved, approved with conditions, or denied.
 - b. The Town Commission Public Hearing shall be advertised at least once in a local newspaper of general circulation or publicly posted in the Town Hall at least ten days prior to the Public Hearing. Written courtesy notices shall be sent by first class mail to affected property owners within a radius of 300 feet and shall contain a copy of the Beach Furniture Permit application.

A notice, 18 inches by 24 inches, shall be placed in a prominent place on the property by the applicant at the applicant's own expense denoting the following:

REQUEST FOR: _____

TOWN COMMISSION MEETING: DATE AND TIME

TOWN HALL
9293 Harding Avenue
Surfside, FL 33154

COMPLETE INFORMATION REGARDING THE BEACH FURNITURE PERMIT APPLICATION IS AVAILABLE BY CONTACTING THE TOWN HALL.

B. C. Exemption. Nothing in this article shall require a permit from a member of the general public to place beach furniture on the public beach for personal use.

C. D. Review of Beach Furniture Permit application. A permit shall be granted upon the submittal of a completed application and the required fee, unless the Town Manager or designee or the Town Commission for Beach Furniture Permit applications pursuant to Section 86-31(B)(2) of the Town Code, determines that the granting of such a permit:

- (1) Unduly impedes governmental business or public access;
- (2) Conflicts with previously scheduled activities;
- (3) Imperils public safety; or
- (4) Violates any public policy or local, state or federal law.

D. E. A Beach Furniture Permit is revocable if the applicant does not meet the requirements as specified in the Town Code, Administrative Policy: Beach Furniture and Equipment and applicant's operation plan. A hotel Beach Furniture Operator is subject to the provisions of Article II "Local Business Tax Receipt" of Chapter 70 of the Town Code.

E. F. Appeals. If a Beach Furniture Permit is denied or revoked by the Town Manager or designee, the Beach Furniture Operator may, within 30 days of the decision, file a notice of appeal to the Town Commission. The appeal shall be heard as a quasi-judicial matter.

Sec. 86-33. - Violations, Civil fines and penalties.

Any person or entity found to be in violation of any condition of this section ~~the permit~~ issued herein shall first be issued a warning. Failure to correct the violation within one hour following the issuance of a warning shall result in the issuance of a Civil Violation Notice ~~to the Beach Furniture Operator. The notice shall be as provided pursuant to in~~ Section 15-10 of the Town Code. ~~Failure to correct the violation may result in revocation of the permit. Failure to obtain the required permit shall subject the owner to a fine of \$500 per day.~~

Violations of this section shall be subject to the following fines.

- a. If the violation is the first violation-\$100.00
- b. If the violation is the second violation within the preceding 12 months-\$500.00

c. Any subsequent violation after the second violation within the preceding 12 months-\$1,000.00

d. After the third violation, a Beach Furniture Operator shall be suspended from Beach Furniture operations for a period of one year from the date of violation.

Section 4. Severability. If any section, subsection, clause or provision of this Ordinance is declared invalid or unconstitutional by a court of competent jurisdiction, the remainder shall not be affected by such invalidity.

Section 5. Conflict. All sections or parts of sections of the Town of Surfside Code of Ordinances in conflict herewith are intended to be repealed to the extent of such conflict.

Section 6. Inclusion in the Code of Ordinances. It is the intention of the Town Commission, and it is hereby ordained that the provisions of this Ordinance shall become and made a part of the Town of Surfside Code of Ordinances, that the sections of this Ordinance may be renumbered or relettered to accomplish such intentions; and the word "Ordinance" may be changed to "Section" or other appropriate word.

Section 7. Effective Date. This Ordinance shall be effective upon final adoption on second reading.

PASSED and ADOPTED on first reading this 9 day of May, 2017.

PASSED and ADOPTED on second reading this 13 day of June, 2017.

On Final Reading Moved by: Commissioner Gielchinsky
On Final Reading Second by: Commissioner Karukin

FINAL VOTE ON ADOPTION

Commissioner Daniel Gielchinsky
Commissioner Michael Karukin
Commissioner Tina Paul
Vice Mayor Barry Cohen
Mayor Daniel Dietch

yes
yes
Absent
no
yes



Daniel Dietch, Mayor

ATTEST:



Sandra Novoa, MMC, Town Clerk

APPROVED AS TO FORM AND LEGALITY FOR THE USE AND BENEFIT OF THE TOWN OF SURFSIDE ONLY:

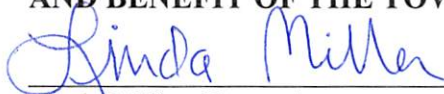

Linda Miller, Town Attorney

Administrative Policy

June 13, 2017.

BEACH FURNITURE AND EQUIPMENT

It is the purpose of this Administrative Policy to further the intent of the adopted Town Ordinance regulating the use of beach furniture within the corporate limits of the Town of Surfside.

A permit issued by the Town is required before a Beach Furniture Operator, as defined in the Ordinance, may place furniture on the beach.

The following are the guidelines for placement of furniture on the beach:

1. Beach furniture may not be placed directly behind of or in front of a lifeguard tower or within 10 feet of the entire perimeter of the lifeguard tower, or obstruct a lifeguard's or emergency personnel's view of the beach or ocean.
2. No Beach Furniture Operator shall place beach furniture in the area immediately adjacent to or directly seaward of the street ends throughout the Town of Surfside.
3. All beach furniture shall be set at no less than 12 feet seaward of the edge of the vegetation line of the dune.
4. Beach Furniture Operator that is a hotel shall submit an operations plan to be reviewed by the Town Manager which includes specifications on set up, number of chairs to be preset (not to exceed 40) and stored, removal procedures, hours, storage, staffing and clean-up.
5. Beach Furniture Operator that is a Condominium Association shall submit an operations plan to be reviewed by the Town Manager which includes specifications on set up, number of chairs to be preset (not to exceed 10% of the number of dwelling units of the Condominium) and stored, removal procedures, hours, storage, staffing and clean-up.
6. Beach furniture shall not be set out in the morning before sunrise, or before completion of daily monitoring for turtle nesting activity by a Florida Fish and Wildlife Conservation Commission authorized marine turtle permit holder to examine the beach in the area of the authorized activity to ensure any new sea turtle nests are identified and marked, whichever occurs first.

7. The Beach Furniture Operator shall be responsible for ensuring that the beach furniture is clearly identified as to its ownership, maintained in good condition, free from evidence of deterioration, weathering, and discoloration, at all times. Beach furniture shall be approved by the Town Manager and such approval shall not be unreasonably withheld.
8. Beach furniture shall be deployed in a manner to assure public access and to encourage public use of the beach and shall cause no obstruction to the general public.
9. A Beach Furniture Operator may store beach furniture on their property or east of the dune neatly organized and secured to the ground.
10. Any request from a Code Enforcement Officer, or lifeguard to relocate beach furniture shall be complied with immediately.
11. In the event of a declared state of emergency, the Town Manager or designee may issue a warning to the Beach Furniture Operator to remove and secure the beach furniture. If the Beach Furniture Operator fails to remove the beach furniture, the Town Manager or designee, at its option, may remove the beach furniture from the public beach. The Beach Furniture Operator shall be liable for all costs incurred by the Town for the removal and storage of the beach furniture in the event of an emergency.

Beach Furniture Operators (11) and
Their Pre-Set Limits
(as of October 1, 2019)

Azure Condos 8

Carlisle on the Ocean Condo 12

Grand Beach Hotel 35

Fendi Chateau Ocean Condo 6

Four Seasons Hotel 31

Marriott Residence Inn No Pre-set allowed / 40 chairs
maximum for all days and at all times.

Solara Surfside Resort 6

Solimar Condos 21

Spiaggia Condos 10

Surfside Towers Condo 13

The Waverly Condo Association 11



MEMORANDUM

ITEM NO. 4WW

To: Honorable Mayor, Vice-Mayor and Members of the Town Commission
From: Guillermo Olmedillo, Town Manager
Date: May 26, 2020
Subject: Designated (Painted) Walking Areas in the Residential District

At the April 16th, 2020 Special Commission Meeting, Town Administration was directed to provide a plan to create designated (painted) pedestrian areas in the single-family residential district. The Town Administration reviewed implemented plans in nearby municipalities to determine available options and related costs.

Due to width limitations of residential roadways and the shared purpose of roadways for vehicular circulation, parking, pedestrian and non-motorized vehicles, the Town Commission should consider creating only one designated (painted) walking areas along the roads. In addition, the Town Commission should also give direction indicating the streets to be considered. The minimum allowed sidewalk width for the American Disability Act (ADA) purposes is 36-inches. For purposes of the designated (painted) walking area, a 5-foot width is considered for use which is a typical residential concrete sidewalk width.

A typical Town block within the residential area is approximately 240-feet wide from west to east and 635-feet long from north to south. For purposes of pricing, a typical unit block will be considered as 875-feet which includes the combination of 240-feet wide from west to east and 635-feet long from north to south. For example, a typical block with proposed designated (painted) walking area can be Carlyle Avenue from 90th Street to 91st Street (northern) and Carlyle Avenue to Dickens Avenue along 91st street (eastern).

Picture A – “*Typical Unit Block*” below outlines a visual representation of a typical unit block and proposed pathway along one side of street and avenue.



Picture A – “*Typical Unit Block*”

The Town reviewed previous projects by City of Miami Beach, Bay Harbor Islands and obtained private market pricing from vendors in order to determine a unit cost per typical block. As a result, **Table A – “Cost Options”** below was composed in order to provide cost options for various designated walking areas in the residential district:

Option Number	Description of Option	Cost per Linear Feet	Total Cost per Typical Unit Block
1	White Line Shared Lane	\$2.50	\$2,187.50
2	Green Cover Shared Lane	\$45.00	\$39,375.00

Table A – “Cost Options”

Attachment A – “Visual Representations” provides a visual representation of each option as installed in actual locations and provides further description of each option.

The Town Administration seeks direction about the streets to be designated so that a total plan can be prepared with cost, procurement recommendation and time of execution.

Reviewed by: GO

Prepared by: HG



OPTION A - WHITE SHARED LANE

White shared lane samples were installed as part of a previous project within the Town of Surfside. In installed samples, the white shared lanes are of pavement paint material. The cost option is priced as thermoplastic marking which creates a reflection during night time and has a longer duration life.



OPTION B - GREEN COVER SHARED LANE

This option is typical of bicycle and shared use lanes. Shared use lanes are depicted by two arrows above bicycle icon. The option can be encountered along Byron Ave between 85th Street to 87th Street within the City of Miami Beach. The material is a proprietary material only applied by a limited amount of contractors. The bicycle icon can be removed or changed to a pedestrian similar to Option A.

LAST REVISION 05/19/2020	DESCRIPTION: OPTIONS FOR SHARED LANES	 TOWN OF SURFSIDE	PAINTED LANES OPTIONS SCALE: N.T.S. SHEET 1 of 1
-----------------------------	--	--	--

To: Honorable Mayor, Vice-Mayor and Members of the Town Commission
From: Guillermo Olmedillo, Town Manager
Date: April 14, 2020
Subject: Comparison of 2006 code to 2020 code

The attached tables describe the differences between the 2006 code and the 2020 code per zoning district. The most significant changes from the 2006 code are summarized below:

1. Single family district requires additional setbacks for second story and limits the square footage of a second story based on the percentage of the first story.
2. Single family homes have a 10-foot base flood elevation requirement versus 8 feet in 2006 in keeping with FEMA requirements.
3. Single family lot coverage (what can be seen under roof from above) currently has certain exclusions, such as patios. Previously, anything under roof qualified as lot coverage.
4. Multifamily properties on the east side of Harding Avenue can have a length up to 90 feet if there is a 17-foot gap in the façade. Previously, the requirement was a maximum of 50 feet with the option to go up to 100 feet with a 25-foot recess.
5. Multifamily properties on the west side of Collins Avenue can have a length up to 250 feet if there is a 17-foot gap in the façade versus 150 feet, however hotels are limited to 150 feet in length.
6. Significant landscape requirements for multifamily and hotel uses were added.
7. Height is limited by the Charter and has not been changed in any district. It should be noted that the increase in base flood elevation means that the first habitable floor is higher now than prior to 2006. However, height is measured from the crown of the road to the top of the building and therefore the increase in base flood elevation has not increased overall height.
8. Minimum window openings, design features and wall plane elevation changes were added to all zoning districts.

Single family waterfront lots		RS-1 (2006 Code)	H30A (2020 Code)
Height	Principal Building	30 ft	30 ft
	Accessory	12 ft	12 ft
Height	Stories	2	2
	Base Flood Elevation	8 ft	10 ft
Lot	Lot Width (Min)	50 ft	50 ft
	Lot area / dwelling (Min)	8,000 sq ft	8,000 sq ft
Lot	Lot Coverage (Max)	40%	40%
	Minimum FI Area (Min)	2,500 sq ft	No minimum, changed to a maximum square footage for 2 nd floors
Setbacks (Min)	Primary	20 ft	20 ft
	Interior side	5 ft	5 ft
Setbacks (Min)	Interior side for lots over 50 ft in width	10% of frontage	10% of the frontage
	Second floor interior side setbacks	No additional setbacks required	An average of 5 – 10 additional feet depending on the size of the 2 nd story, not to exceed 80% of the first
Pervious Area (Min)	Rear	20 ft	20 ft
	Secondary (corner only)	10 ft	10 ft
Pervious Area (Min)		50% of front yard and 40% of rear yard to be landscaped.	35% minimum pervious area for total lot. 50% of front yard and 20% of rear yard to be landscaped.

Single family interior lots		RS-2 (2006 Code)	H30B (2020 Code)
Height	Principal Building	30 ft	30 ft
	Accessory	12 ft	12 ft
Height	Stories	2	2
	Base Flood Elevation	8 ft	10 ft
Lot	Lot Width (Min)	50 ft	50 ft
	Lot area / dwelling (Min)	5,600 sq ft	5,600 sq ft
Lot	Lot Coverage (Max)	40%	40%
	Minimum FI Area (Min)	1,800 sq ft	No minimum, changed to a maximum square footage for 2 nd floors
Setbacks (Min)	Primary	20 ft	20 ft
	Interior side	5 ft	5 ft
Setbacks (Min)	Interior side for lots over 50 ft in width	10% of frontage	10% of the frontage
	Second floor interior side setbacks	No additional setbacks required	An average of 5 – 10 additional feet depending on the size of the 2 nd story, not to exceed 80% of the first
Pervious Area (Min)	Rear	20 ft	20 ft
	Secondary (corner only)	10 ft	10 ft
Pervious Area (Min)		50% of front yard and 40% of rear yard to be landscaped.	35% minimum pervious area for total lot. 50% of front yard and 20% of rear yard to be landscaped.

		RD-1 (2006 Code)			H30C (2020 Code)
Determination	Single family	Two-family	Multi-Family	Zoning District	
Height (Max)	Principal Building	30 ft	30 ft	30 ft	
	Accessory	12 ft	12 ft	12 ft	
	Stories	2	2	2	
Lot	Lot Width (Min)	50 ft	50 ft	75 ft	50 ft
	Lot area / dwelling (Min)	5,000 sq ft	2,500 sq ft	2,000 sq ft	Not Specified
	Lot Coverage (Max)	Not Specified	Not Specified	Not Specified	Not Specified
Setbacks (Min)	Minimum FI Area (Min)	1,800 sq ft	950 Sq ft	Based on use	Based on use
	Primary	20 ft	20 ft	20 ft	20 ft
	Interior side	5 ft	5 ft	7 ft	6 ft minimum or 10% of the total interior frontage up to 15 ft, whichever is greater
Maximum frontage	Interior side for lots over 50 ft in width	10% of frontage	10% of frontage	10% of frontage	6 ft minimum or 10% of the total interior frontage up to 15 ft, whichever is greater
	Rear	20 ft	20 ft	10 ft	10 ft
	Secondary (corner only)	10 ft, 15 ft on east west lots	10 ft, 15 ft on east west lots	10 ft, 15 ft on east west lots	10 ft
Pervious Area (Min)		100 feet with 25 foot recesses or 50 feet without recesses	100 feet with 25 foot recesses or 50 feet without recesses	100 feet with 25 foot recesses or 50 feet without recesses	90 feet subject to 3 conditions; and equivalency
		50% of the front setback, 40% of rear setback	50% of the front setback, 40% of rear setback	50% of the front setback, 40% of rear setback	20%

		RM-1 (Old Code)		H40 (2020 Code)	
	Determination	Multi Family	Hotel & Motel	Width is ≤ 50 ft	Width is > 50 ft
Height (Max)	Principal Bldg	40 ft	40 ft	40 ft	40 ft
	Accessory	Not Specified	Not Specified	12 ft	12 ft
	Stories	3	3	1 and 2 family = 2 MF and Hotel = 3	1 and 2 family = 2 MF and Hotel = 3
Lot	Lot Width (Min)	75 ft	100 ft	50 ft	50 ft
	Lot area / dwelling (Min)	750 Sq ft	400 Sq ft	Not Specified	Not Specified
	Lot Coverage (Max)	Not Specified	Not Specified	Not Specified	Not Specified
	Minimum FI Area (Min)	Based on use	Based on Use	Not Specified	Not Specified
Setbacks (Min)	Primary*	20ft	20 ft	20 ft; 25 ft for portions above 30 feet; except historic bldgs.	20 ft; 25 ft for portions above 30 feet; except historic bldgs.
	Interior side	7 ft	7 ft	6 ft minimum or 10% of the total interior frontage up to 15 ft, whichever is greater	7 ft minimum or 10% of the total interior frontage up to 15 ft, whichever is greater
	Interior side for lots over 50 ft in width	10% of frontage	10% of frontage	6 ft minimum or 10% of the total interior frontage up to 15 ft, whichever is greater	7 ft minimum or 10% of the total interior frontage up to 15 ft, whichever is greater
Maximum frontage	Rear	10ft	20 ft	10 ft	10 ft
	Secondary (corner only)	10ft	10 ft	10 ft	10 ft
Pervious Area (Min)	Maximum frontage	150ft with 25 foot recesses or 75 feet without recesses	150ft with 25 foot recesses or 75 feet without recesses	150 ft for hotels, 150 ft, or up to 250 ft with equivalent gaps of 17 ft in width for multi-family	150 ft for hotels, 150 ft, or up to 250 ft with equivalent gaps of 17 ft in width for multi-family
	Pervious Area (Min)	50% of the front setback, 40% of rear setback	50% of the front setback, 40% of rear setback	50% of the front setback plus 20% of overall site	50% of the front setback plus 20% of overall site

*2006 code identified the "primary" front setback on a corner lot as the shorter of the two streets. This was modified in the current code to add that if the parcel is on Collins or Harding, that frontage becomes the primary front setback, regardless if the Collins or Harding portion of the lot is shorter. This to provide greater setbacks on Collins and Harding.

		RT-1 (2006 Code)		H120 (2020 Code)	
<u>Determination</u>		<u>Multi-Family</u>	<u>Hotel and Motel</u>	<u>Zoning District</u>	
Height (Max)	Principal Building	120 ft	120 ft	120 ft	
	Accessory	Not Specified	Not Specified	12 ft	
Lot	Stories	12	12	12	
	Lot Width (Min)	100 ft	150 ft	50 ft	
	Lot area / dwelling (Min)	400 Sq ft	Not Specified	Not Specified	
	Lot Coverage (Max)	Not Specified	Not Specified	Not Specified	
	Minimum FI Area (Min)	Based on use	Based on use	Based on use	
Setbacks (Min)	Primary	40 ft	40 ft	40 ft	
	Interior side	10 ft, additional side setbacks when the building exceeds 30 feet in height.	10 ft, additional side setbacks when the building exceeds 30 feet in height.	10% of the frontage, no less than 10 feet, additional side setbacks when the building exceeds 30 feet in height.	
	Rear	30 ft	30 ft	30 ft	
	Secondary (corner only)	20 ft	20 ft	10% of the lot frontage, no less than 20 feet	
Maximum frontage	150 ft	150 ft	150 ft		
Pervious Area (Min)	50% of the front setback	50% of the front setback	20%		



MEMORANDUM

ITEM NO. 4BBB

To: Honorable Mayor, Vice-Mayor and Members of the Town Commission
From: Guillermo Olmedillo, Town Manager
Date: June 23, 2020
Subject: Stormwater Master Plan

At the April 28th, 2020 Special Commission Meeting, Town Administration was directed to report back to the Commission regarding the Town's statutory requirement for a Stormwater Master Plan. The following information relates to the requirements and uses for Stormwater Master Plan.

- If a municipality operates a stormwater utility (such as the Town does), a stormwater management program is required by FS 403.0891, which includes stormwater master plan for planning and improvement purposes per Rule 62-40.431(3)(d), Florida Administrative Rules. The County requires that National Pollution Discharge Elimination System (NPDES) regulations and best management practices are followed for water quality, which is a stormwater management program, not a stormwater master plan.
- The difference – A Stormwater Master Plan is a planning tool; the management program is a compliance tool.
 - The Stormwater Master Plan considers and models existing flooding areas (often identified by staff and residents) and future conditions (such as sea level rise) in order to:
 - Develop solutions to improve the flooding level of services (LOS)
 - Establish Future goals and regulations.
 - Recommend a capital improvement program that is both technically sound and financially supportable.
 - Provide a foundation for future policy decisions.
 - Incorporate and update the stormwater management plan in order to comply with state and federal National Pollutant Discharge Elimination System (NPDES) regulations.
- Most local governments have a Stormwater Master Plan and update it every 5-10 years to keep it current since it establishes the Capital Improvement Program (CIP) and helps stay in compliance with NPDES requirements.

The Town did commission the completion of portions of the plan (ICPR model) in 2008 as part of the infrastructure rehabilitation project but did not commission the completion of a complete Stormwater Master Plan.

To address the Commissions inquiries regarding costs of the plan, we have compiled the data on Stormwater Master Plan costs from other jurisdictions. These plans were publicly bid and not completed by CGA; they were completed by other engineering firms.

	SqMiles	Price	Year	Years ago	Avg CPI increase	Adjusted CPI Price	\$/SQ Mi
Port Ft Pierce	0.04	\$ 188,663.00	2018	2	2.50%	\$198,214.06	\$5,663,258.98
Bal Harbour Village	0.38	\$ 136,675.00	2014	6	2.50%	\$158,501.10	\$417,108.15
Golden Beach	0.32	\$ 168,800.00	2000	20	2.50%	\$276,598.46	\$864,370.17
Surfside	0.56	\$ 175,980.00	2020	0	2.50%	\$175,980.00	\$314,250.00
Key Biscayne	1.25	\$ 293,000.00	2011	9	2.50%	\$365,916.85	\$292,733.48

Reviewed by: JG/LA

Prepared by: CG



MEMORANDUM

ITEM NO. 4CCC

To: Honorable Mayor, Vice-Mayor and Members of the Town Commission

From: Guillermo Olmedillo, Town Manager

Date: June 23, 2020

Subject: Big Belly Contract Termination Replacement and Replacement Bins for Trash and Recycling Receptacles Throughout Town

Currently, the Town of Surfside has Big Belly compactor trash and recycling receptacles throughout Town for litter control. Due to anticipated upcoming budgetary constraints, the Town Commission has directed Town Administration to locate areas to cut costs. During the Budget Goals Workshop on May 5, one area identified was the multi-year contract for Big Belly compactor trash and recycling receptacles. If the Commission doesn't approve any appropriation towards the Big Belly program, the Town may terminate the contract per Section 6.16 Fiscal Funding.

The Town would be able to eliminate the \$46,658 per fiscal year or \$186,632 on the remaining 4 (four) year contract term costs. This savings would be partially offset by a one-time cost of between \$38,336 and \$59,666 replacement manual trash and recycling receptacles. This would mean between \$148,296 and \$126,966 costs savings to the Town over the next 4 (four) fiscal years based on the type of replacement trash and recycling receptacle chosen.

With the removal of the Big Belly trash compactor trash and recycling receptacles, new containers will be required in order to maintain continuity with litter control in Downtown Surfside and other areas within the Town where trash and recycling bins are currently deployed. The current Big Belly fleet is 29 dual stations which each station having a trash and recycling receptacle. A total of 30 dual stations to replace existing trash and recycling containers (for a total of 60 containers) will need to be procured.

Town Administration requested quotes from various vendors along with specification sheets. A breakdown of quotes and specifications can be found in **Table A – “Trash and Recycling Bin Options” below**:

Item number	Description	Total Quantity	Total Cost	Lead Time	Attachment Sheet
1	Stadium Series	60	\$41,055.90	6-8 Weeks	"A"
2	Personalized Trash / Recycling Bins	30	\$38,336.36	10 Weeks	"B"
3	Oakley Collection	60	\$50,126.07	4 Weeks	"C"
4	Claremont Double Stations	30	\$59,262.03	4-6 Weeks	"D"
5	Manchester Sideload Double Station	30	\$59,665.75	4-6 Weeks	"E"
6	Vancouver Combo Station	30	\$49,532.00	4-6 Weeks	"F"

Table A – “Trash and Recycling Bin Options” below

Table A – “Trash and Recycling Bin Options” references an attachment sheet for each option. The attachment includes a specification sheet, provided quote and additional information. The information is being provided to the Town Commission in order to review and approve an option for procurement purposes. The new receptacles would need to be purchased in the Fiscal Year 2020 prior to the de-funding of the Big Belly program in order to maintain continuity of litter control. A budget amendment will be presented at the next Commission meeting along with an approval to purchase the selected receptacle.

Reviewed by: JG/LA

Prepared by: HG/JG

Attachment "A"

Stadium Series Specifications

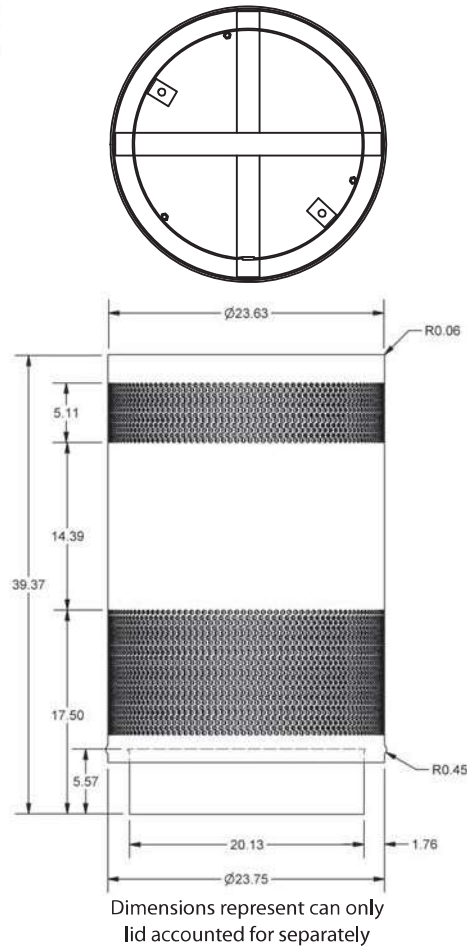

Product Features

- Custom logo capability to convey branding (see other models)
- 14 GA. Galvaneal metal
- Kick Plate Material: 12 GA. Galvaneal metal
- Bottom Cross Bar Supports: Cross Bars: (2) 7 GA. X 2" Steel bars in criss cross pattern to allow maximum drainage
- Flat Top Lid: .125 ABS Material with Textured Finish w/16" hole opening and 2" flanges
- Perforation Pattern: 3/8" Hole on 9/16" Stagger with 60 Degree Spacing
- Unit comes standard with 3 Stainless Steel Leveling Feet, Anchoring Feet, Anchor Kit and Lid Attachment Kit
- TGIC Polyester Powder Coat outdoor finish
- Custom colors available to match organizational branding

Options include:

- 3 Tops to choose from: Flat Top, Hood Top or Dome Top

Bottom Kick Plate Options:

- Plastic dipped base for durability and to protect your surfaces

BOTTOM VIEW

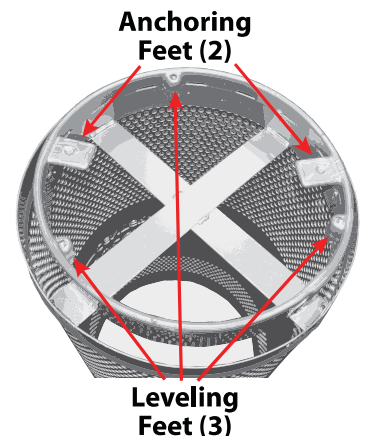

	Capacity	Dimensions	Weight
Page 464	55 gallons	23 1/2" dia x 40" high	86 lbs



450 SERIES POWDERCOAT - AVAILABLE COLORS



Blue Streak



Post Office
Blue



Blue

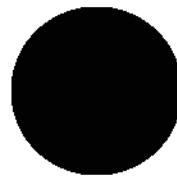

Black

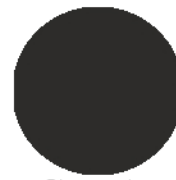

Charcoal



Bumper
Black



Taupe



Almond



Cream

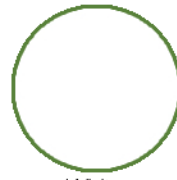

White



Brown



Ultra
Orange



Yellow



Red



Red Baron



Deep Red



Scarlet
Red



Burgundy



Brass Gold



Green



Equipment
Green



Evergreen

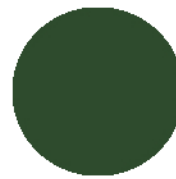

Moss Green



Purple



Silver Vein

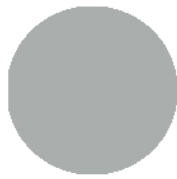

Stainless
Steel



Silver



Stone Gray



Slate

This color chart is for reference only and is not to be used for final color matching. Shades may vary due to the color and resolution of your computer screen and/or your color printer output.



Park Warehouse LLC
 7495 W. Atlantic Ave., Suite #200-294
 Delray Beach, FL 33446
 888-321-5334

**Quality Commercial Site Furnishings for
 Municipalities, Schools & Property Managers**

Billing

Hector Gomez
 Town of Surfside - Public Works
 9293 Harding Avenue
 Surfside, FL 33154
 Phone: 7867781728

Shipping

Hector Gomez
 Town of Surfside - Public Works
 9293 Harding Avenue
 Surfside, FL 33154

Quote: Q221756

Quote Date **Quote Expiration**
 June 5, 2020 30 Days (07/05/2020)

Sales Rep: Rosealee x521
Ref#:

\$41,055.90
 If you receive a lower quote, please remember our
 best price guarantee!

Description	SKU	Cost	Qty	Total
Stadium Series - Round - Trash Receptacle - w/ Plastic Liner & Flat Top Lid Capacity: 35 Gallons	450tr325-3	\$669.00 \$609.00	30	\$20,070.00 \$18,270.00
450 Series - Trash Receptacle Product 1 - Special Description : -Stadium Series -35 Gallon Recycle Logo Receptacle -Recycle Flat top Lid -Liner Color : Blue Streak With White Logo Recycle Flat top Lid: -Hole Option -TBD ** Free shipping ***: Free shipping on qty of 60 quoted	450-SPCL-TRASHRECEPTACLE-1	\$713.41 \$670.00	30	\$21,402.30 \$20,100.00

Discount	\$3,102.30
Subtotal	\$38,370.00
Shipping	\$0.00
Tax 7%	\$2,685.90
Total	\$41,055.90

Quote Note: All Trash can are made to -special order and therefore are non-cancellable and non-returnable. *** FREE SHIPPING ON QTY QUOTED OF 60*** Lead time to ship out is-6-8 weeks ** NO LIFT GATE SERVICE



Park Warehouse LLC

7495 W. Atlantic Ave., Suite #200-294

Delray Beach, FL 33446

888-321-5334

**Quality Commercial Site Furnishings for
Municipalities, Schools & Property Managers**

Attachment "B"

32 GAL. PERSONALIZED TRASH/RECYCLING BINS +/-liners, ashcan
SKU: 287tr180

Wt. 200 lbs

photo

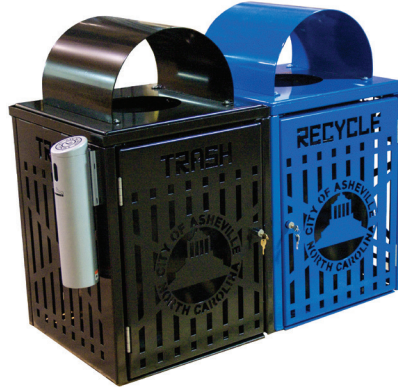

top view

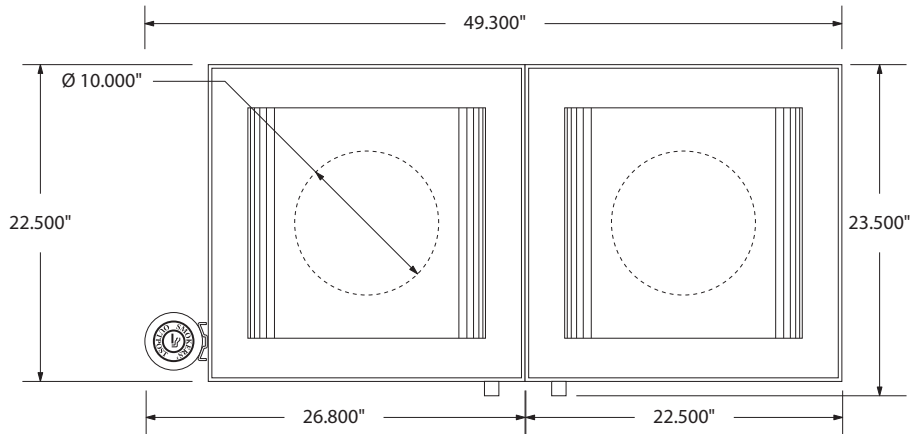

front view

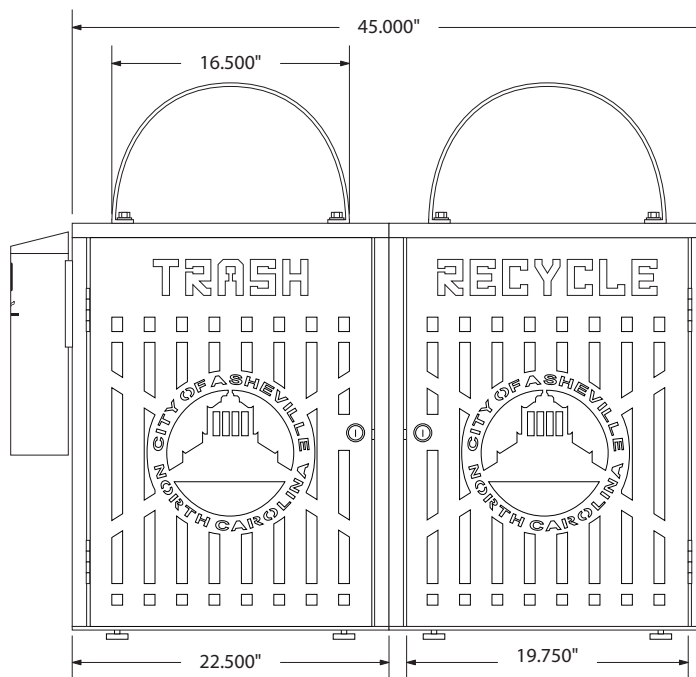

side view

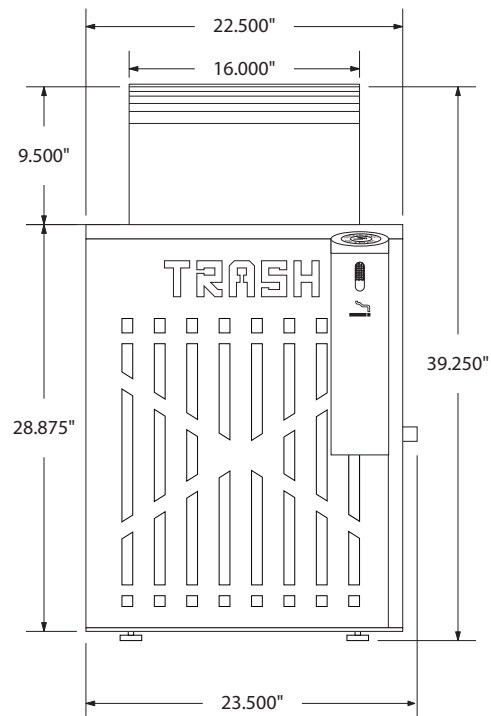

product details



Receptacles

- Dual dome lids are securely fastened
- 11 Gauge steel construction with diamond pattern in panel surfaces
- City of Asheville Seal is manufactured in each door
- Complete with secured cigarette ash/snuffer mounted on the side of the receptacles
- Eight [8] interior mounting holes for securing placement
- Eight [8] heavy-duty mounting levelers
- Dual front doors [labeled Trash on left and Recycle on right] secured with stainless steel hinges and hardware
- Both doors are keyed alike and lockable
- All units are coated with zinc primer and polyester powdercoat finish (black on Trash, blue on Recycle)
- All hardware is zinc coated
- All units shipped assembled
- 5 Year warranty



Liner:

- Black, square polyethylene plastic liners with hand holes [2] included



287 SERIES THERMOPLASTIC - AVAILABLE COLORS



BLACK



RED



ORANGE



YELLOW



GREEN



BLACK GREEN



TEAL



BLUE



NAVY



PURPLE



BURGUNDY



BROWN



BEIGE



SANDSTONE



GRAY

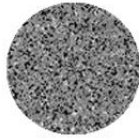

GRANITE



Park Warehouse LLC
 7495 W. Atlantic Ave., Suite #200-294
 Delray Beach, FL 33446
 888-321-5334

**Quality Commercial Site Furnishings for
 Municipalities, Schools & Property Managers**

Billing

Hector Gomez
 Town of Surfside - Public Works
 9293 Harding Avenue
 Surfside, FL 33154
 Phone: 7867781728

Shipping

Hector Gomez
 Town of Surfside - Public Works
 9293 Harding Avenue
 Surfside, FL 33154

Quote: Q221735

Quote Date **Quote Expiration**
 June 4, 2020 30 Days (07/04/2020)

Sales Rep: Rosealee x521
Ref#:

\$38,336.36

**If you receive a lower quote, please remember our
 best price guarantee!**

Description	SKU	Cost	Qty	Total
32 Gallon - Trash & Recycle Receptacle Combo - With Plastic Liner & Lids - With Security Doors - No Option Configuration: No Option	287tr180-1	\$1,224.00	30	\$36,720.00
		\$1,101.60		\$33,048.00

Discount	\$3,672.00
Subtotal	\$33,048.00
Shipping	\$2,975.00
Tax 7%	\$2,313.36
Total	\$38,336.36

Quote Note: LEAD TIME TO SHIP OUT IS 5 WEEKS

Attachment "C"

Oakley Standard Trash Receptacle

Sku: 450tr120

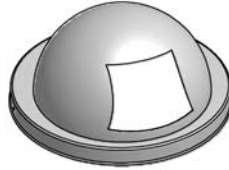

Dome Top (DT) Lid Option



Rain Cap (RC) Lid Option



Ash & Trash (AT) Lid Option



Flat Top (FT) Lid Option

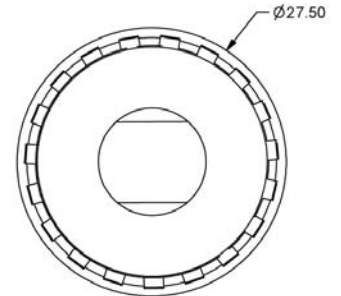

Top View

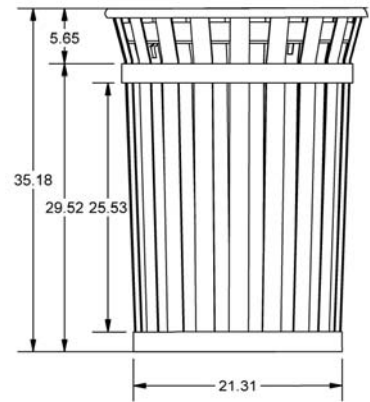

Front View

Dimensions represent can only
lid accounted for separately

Product Features

- Made from 1/8" X 2" galvanized steel slats
- Has 1" top tube
- Includes 1/8" x 2" steel horizontal bands
- TGIC Polyester Powder Coat outdoor finish
- Material is chemically prepared and zinc rich primed prior to paint
- Available in three standard colors: Black (PMS # 6C), Brown (PMS # 426C) or Green (PMS # 346C)
- Custom colors available upon request
- Unit comes Standard with 3 Stainless Steel Leveling Feet, Anchor Kit, and Lid Attachment Kit
- Black high density polyethylene rigid plastic liner
- 4 Lids options available

Dome Top (DT), Rain Cap (RC), Ash / Trash Top(AT) and Flat Top (FT)

	Capacity	Dimensions	Weight	Finishes
Page 476	36 gallons	27 1/2" dia x 35 1/4" high	95 lbs	Black (BK), Green (GN), Brown (BN)



287 SERIES THERMOPLASTIC - AVAILABLE COLORS

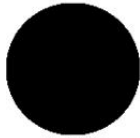

BLACK



RED



ORANGE



YELLOW



GREEN



BLACK GREEN



TEAL



BLUE



NAVY



PURPLE



BURGUNDY



BROWN



BEIGE



SANDSTONE



GRAY

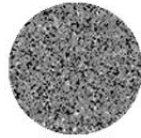

GRANITE



Park Warehouse LLC
 7495 W. Atlantic Ave., Suite #200-294
 Delray Beach, FL 33446
 888-321-5334

**Quality Commercial Site Furnishings for
 Municipalities, Schools & Property Managers**

Billing

Hector Gomez
 Town of Surfside - Public Works
 9293 Harding Avenue
 Surfside, FL 33154
 Phone: 7867781728

Shipping

Hector Gomez
 Town of Surfside - Public Works
 9293 Harding Avenue
 Surfside, FL 33154

Quote: Q221754

Quote Date **Quote Expiration**
 June 4, 2020 30 Days (07/04/2020)

Sales Rep: Rosealee x521
Ref#:

\$50,126.07
 If you receive a lower quote, please remember our
 best price guarantee!

Description	SKU	Cost	Qty	Total
Oakley Collection - Recycling Receptacle w/ Flat Top & Plastic Liner - Slatted Metal - 36 Gallon Capacity: 36 Gallon	450tr180-1	\$872.00 \$793.52	30	\$26,160.00 \$23,805.60
Oakley Standard - Round - Trash Receptacle - w/ Plastic Liner - Slatted Metal Capacity: 36 Gallon Lid Type: tbd Color : TBD ** Free shipping ***: Free shipping on qty of 60 quoted	450tr120-5	\$844.00 \$768.04	30	\$25,320.00 \$23,041.20

Discount	\$4,633.20
Subtotal	\$46,846.80
Shipping	\$0.00
Tax 7%	\$3,279.27
Total	\$50,126.07



Park Warehouse LLC

7495 W. Atlantic Ave., Suite #200-294

Delray Beach, FL 33446

888-321-5334

**Quality Commercial Site Furnishings for
Municipalities, Schools & Property Managers**

Quote Note: *** FREE SHIPPING ON QTY QUOTED OF 60*** Lead time to ship out is-4 weeks ** NO LIFT GATE SERVICE

Attachment "D"

TYPE 2

The CLAREMONT

Key features:

- Constructed with 97% pure Type 2 recycled plastic
- Offered in a variety of colors and panel options
- Attractive solution for recycling programs
- Opening identification and restrictive
- Rigid liner included

Available Colors:

plain panel colors



Material Aesthetics:

- Manufactured from high-grade of recycled HDPE
- Top-of-the-line pigments and UV inhibitors

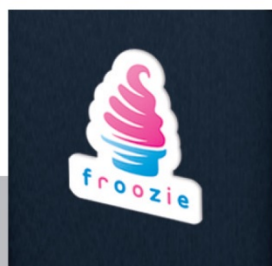

Overlay Logos

4 color printed logo or company name set in the panel of the furnishing.



Overlay Symbols

Help users identify waste streams visually with overlaid symbols. Available in small, medium and large sizes.

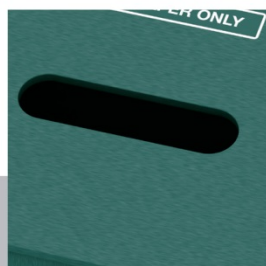

Restrictive Openings

Keep recycling streams from getting contaminated - all at no extra cost.



Opening IDs

Clearly labeled waste and recycling streams help identify openings and reduce cross contamination.



“Slow-Stay” Hinged Lid

Easily open and service bins without worrying about the lid slamming shut.



Seamlessly Built

Flush post-to-panel construction gives these units a clean, stylish appearance without sacrificing strength.

Tested Construction Methods:

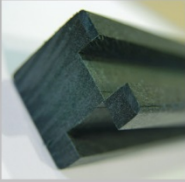

Dado Grooved Posts

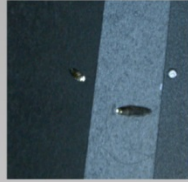

Pocket Screw Joinery



Marine-Grade Hardware



Levelers



Metal Reinforcements

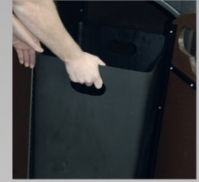

Removable Liner

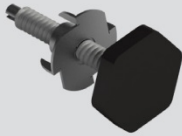

Adjustable Levelers

Ensures longevity of your unit by giving product stability on uneven surfaces.



Casters

Add casters for easy mobility. Regular and lockable casters available.

Configurations

Single

Double

Triple

Topload



*Available in 12-32 Gallon Capacities

Single

Double

Triple

Size

Dimensions

12 Gallon 20"W x 15"D x 30"H
 26 Gallon 29"W x 20"D x 31"H
 32 Gallon 26"W x 20"D x 39"H

Size

Dimensions

12 Gallon 29"W x 15"D x 30"H
 26 Gallon 48"W x 20"D x 31"H
 32 Gallon 42"W x 20"D x 39"H

Size

Dimensions

12 Gallon 43"W x 15"D x 30"H
 26 Gallon 71"W x 20"D x 31"H
 32 Gallon 63"W x 20"D x 39"H

TYPE-2 Material

Type-2 Material is impervious to insects, moisture and mold, meaning it won't rot, splinter or become dinner for pests as wood often does. Added UV inhibitors keep its colors stable while bonding agents create complete molecular linkage for optimum structural integrity.

- Manufactured from high-grade of recycled HDPE, and unlike other plastic recycling centers, contains no foam fillers
- Top-of-the-line pigments and UV inhibitors are used to maintain color for decades



Warranty

Nex-Terra offers a three year limited warranty on all of our products to be free from defects in workmanship and/or material(s). Nex-Terra makes no warranty with respect to either the merchantability of our products, or their suitability for any specific purpose or use.



35 Frost Street, Brattleboro, VT 05301

800.664.5340
sales@recycleaway.com

Customer Information

Buyer: Town of Surfside 9293 Harding Ave Surfside, FL 33154	Bill To: Town of Surfside 9293 Harding Ave Surfside, FL 33154	Ship To: Town of Surfside 9293 Harding Ave Surfside, FL 33154
--	--	--

(786) 778-1728
hgomez@townofsurfsidefl.gov

Shipping and Delivery Notes:
Standard shipping is dock-to-dock and does not include lift-gate, inside delivery, or other special services and assumes the use of a 53' delivery truck. Please let us know if you have special delivery requirements.

Lead time for these containers is : **4 - 6 Weeks**

Quote #0048638

ACCOUNT REP Amanda Gilbert

QUOTE DATE	QUOTE AMOUNT	QUOTE EXPIRES
June 2, 2020	\$56,280.00	July 3, 2020

ITEM CODE	QTY	DESCRIPTION	UNIT PRICE	TOTAL
N6-19202045DP1	30.00	Claremont Double Recycling Station Size: 45 Gallon Left Color: Left Opening: Left Label and Symbol: Right Color: Right Opening: Right Label and Symbol: Website price \$2,048	\$1,876.00	\$56,280.00
<i>Subtotal</i>				\$56,280.00
<i>Tax</i>				\$
<i>Shipping</i>				\$2982.03
Total				\$59,262.03

- To approve your quote via **FAX**: Print, Sign and Fax this page to **888.506.0210**
- To approve your quote via **USMail**: Print, Sign and Mail this page to **Recycle Away, 35 Frost Street, Brattleboro, VT 05301**
- To approve your quote via **Email**, fill out download to us at **sales@recycleaway.com**

Signature: _____

Email: _____

Company: _____

PO# (Optional): _____

Credit Card# (Optional): _____

Exp. / / 3-digit-code: _____

Damages & Returns

Damages - All shipments are insured against damage in transit. If your shipment shows any sign of visual damage, it should be noted on the freight bill or receiving ticket and signed by the driver. If damage to the shipment is not visible until the carton is opened, please keep all of the packing materials and the original carton. In either case, please notify Recycle Away within five days.

Returns - If your order is damaged in shipment, we will either issue credit for the product and the shipping costs, or ship a replacement product at no cost for the product and shipping. If you need to return the purchase for any other reason please notify us within five days. Please note that special orders are non-refundable. The customer must pay for the return shipping and a re-stocking fee of 25, for returned items. The items must be returned in their original cartons in new condition.

35 Frost Street | Brattleboro, VT 05301 | Tel : 800.664.5340 | Fax: 888.506.0210 | Email: sales@recycleaway.com

Attachment "E"



The Manchester Collection

- Manufactured from pure high-grade of recycled HDPE, and unlike other plastic recycling centers, contains no foam fillers. Top-of-the-line pigments and UV inhibitors are used to maintain consistent in the most demanding outdoor environments. The product is virtually maintenance free and never needs painting, never splinters and never becomes food for termites. The units are constructed to last decades, and include pocket screw construction and marine grade hardware throughout.
- Serviced via a stainless steel piano hinged side door for ease of access, and all hinges are marine grade and thus rust resistant.
- Each unit comes with heavy duty liners with handles for easy servicing and lifting.
- Designed for both indoor and outdoor use, and meets all LEED requirements for recycled content, are ADA-compliant and fire safe.
- Our lumber lasts for decades and thanks to our full line of engineered products built with commercial-grade building techniques, the furnishings themselves last just as long.
- The lumber won't absorb moisture, which can lead to rotting and won't harbor insects. It offers many of the characteristics of wood but requires virtually no maintenance!

The Manchester Collection

Construction Features:



Dado Grooved Posts



Pocket Screw Joinery



Marine-Grade Hardware



Piano Hinged Door



Metal Reinforcements



Removable Liner



Container Options:



Casters

Add casters for easy mobility. Regular and lockable casters available.



Cam Locks

To protect valuable streams add cam locks to prevent theft.



Flap Door

Add a basic flap door to fully encase waste contents from view and reduce pest entry



Panel Options

Available with plain or beadboard panels



The Manchester Collection



Design your own bin
in four easy steps:

Choose Your Colors:



Choose Your Openings:

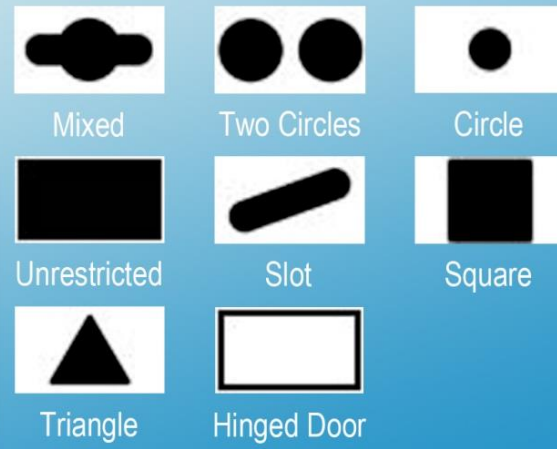

Choose Your Symbols:



Choose Your Labels:



The Manchester Collection



Single Sideload

Size	Dimensions	SKU
26 gallon	39"w × 21"d × 31"h	N3-19201926P2
32 gallon	39"w × 21"d × 36"h	N3-19201932P2
38 gallon	46"w × 24"d × 31"h	N3-19201938P2
45 gallon	46"w × 24"d × 36"h	N3-19201945P2
55 gallon	46"w × 24"d × 40"h	N3-19201955P2

Single-Slim Sideload

Size	Dimensions	SKU
38 gallon	46"w × 24"d × 31"h	N3-19201938SP2P2
45 gallon	46"w × 24"d × 36"h	N3-19201945SP2P2
55 gallon	46"w × 24"d × 40"h	N3-19201955SP2P2



Double Sideload

Size	Dimensions	SKU
26 gallon	38"w × 20"d × 34"h	N3-19201926DP2
32 gallon	38"w × 20"d × 36"h	N3-19201932DP2
38 gallon	50"w × 24"d × 34"h	N3-19201938DP2
45 gallon	50"w × 24"d × 37"h	N3-19201945DP2
55 gallon	50"w × 24"d × 41"h	N3-19201955DP2



The Manchester Collection



Double-Slim Sideload

Size	Dimensions	SKU
38 gallon	50"w × 24"d × 34"h	N3-19201938DSP2P2
45 gallon	50"w × 24"d × 37"h	N3-19201945DSP2P2
55 gallon	50"w × 24"d × 41"h	N3-19201955DSP2P2

Triple Sideload

Size	Dimensions	SKU
26 gallon	38"w × 20"d × 34"h	N3-19201926TP2
32 gallon	38"w × 20"d × 36"h	N3-19201932TP2
38 gallon	50"w × 24"d × 34"h	N3-19201938TP2
45 gallon	50"w × 24"d × 37"h	N3-19201945TP2
55 gallon	50"w × 24"d × 41"h	N3-19201955TP2



Triple-Slim Sideload

Size	Dimensions	SKU
38 gallon	50"w × 24"d × 41"h	N3-19201938TSP2P2
45 gallon	50"w × 24"d × 44"h	N3-19201945TSP2P2
55 gallon	50"w × 24"d × 48"h	N3-19201955TSP2P2



35 Frost Street, Brattleboro, VT 05301

800.664.5340
sales@recycleaway.com

Customer Information

Buyer: Town of Surfside 9293 Harding Ave Surfside, FL 33154	Bill To: Town of Surfside 9293 Harding Ave Surfside, FL 33154	Ship To: Town of Surfside 9293 Harding Ave Surfside, FL 33154
--	--	--

(786) 778-1728
hgomez@townofsurfsidefl.gov

Shipping and Delivery Notes:
Standard shipping is dock-to-dock and does not include lift-gate, inside delivery, or other special services and assumes the use of a 53' delivery truck. Please let us know if you have special delivery requirements.

Lead time for these containers is : **4 - 6 Weeks**

Quote #0048641

ACCOUNT REP Amanda Gilbert

QUOTE DATE	QUOTE AMOUNT	QUOTE EXPIRES
June 2, 2020	\$55,980.00	July 3, 2020

ITEM CODE	QTY	DESCRIPTION	UNIT PRICE	TOTAL
N3-19201945DP2	30.00	Manchester Sideload Double Recycling Station Size: 45 Gallon Left Color: Left Opening: Left Label and Symbol: Right Color: Right Opening: Right Label and Symbol: Website price \$2,038	\$1,866.00	\$55,980.00
			<i>Subtotal</i>	\$55,980.00
			<i>Tax</i>	\$
			<i>Shipping</i>	\$3685.75
			Total	\$59,665.75

- To approve your quote via **FAX**: Print, Sign and Fax this page to **888.506.0210**
- To approve your quote via **USMail**: Print, Sign and Mail this page to **Recycle Away, 35 Frost Street, Brattleboro, VT 05301**
- To approve your quote via **Email**, fill out download to us at **sales@recycleaway.com**

Signature: _____

Email: _____

Company: _____

PO# (Optional): _____

Credit Card# (Optional): _____

Exp. / / 3-digit-code: _____

Damages & Returns

Damages - All shipments are insured against damage in transit. If your shipment shows any sign of visual damage, it should be noted on the freight bill or receiving ticket and signed by the driver. If damage to the shipment is not visible until the carton is opened, please keep all of the packing materials and the original carton. In either case, please notify Recycle Away within five days.

Returns - If your order is damaged in shipment, we will either issue credit for the product and the shipping costs, or ship a replacement product at no cost for the product and shipping. If you need to return the purchase for any other reason please notify us within five days. Please note that special orders are non-refundable. The customer must pay for the return shipping and a re-stocking fee of 25, for returned items. The items must be returned in their original cartons in new condition.

35 Frost Street | Brattleboro, VT 05301 | Tel : 800.664.5340 | Fax: 888.506.0210 | Email: sales@recycleaway.com

Attachment "F"



The Vancouver

Add a burst of color to your community's recycling & waste program with the Vancouver. This round metal container accommodates up to three streams and comes with a sturdy plastic lid and durable body to withstand the elements. The Vancouver will be a pivotal part of keeping your community's outdoor space clean and free of litter.

Best selection, lowest prices.

Call us for Quantity Discounts and Custom Designs!

800.664.5340 www.recycleaway.com

FEATURES

- Array of configurations allow collection for up to three streams
- The pattern aids in stream identification by revealing the brightly colored liners within
- Rigid plastic liners enforce stability
- Ergonomic handles on liners allow for seamless servicing

LID OPTIONS

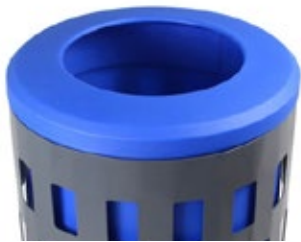

Single - Blue

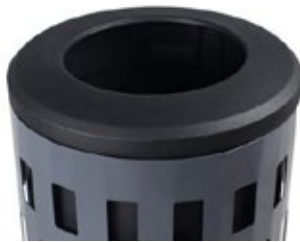

Single - Black



Double



Triple

Flat Top Dimensions: 23" Diameter x 37.5" H



Canopy - Single



Canopy - Double



Canopy - Triple

Canopy Lid Bin Dimensions: 23" Diameter x 46" H



Dome - Black



Dome - Blue

Dome Lid Bin Dimensions: 23" Diameter x 49" H

SPECIFICATIONS

CAPACITY
45 Gallon

STOCK BODY COLOR

● Gray

STOCK LINER COLORS

● Blue ● Green

● Black

*Green Only Available
for Triple

Best selection, lowest prices.

Call us for Quantity Discounts and Custom Designs!

800.664.5340 www.recycleaway.com



35 Frost Street, Brattleboro, VT 05301

800.664.5340
sales@recycleaway.com

Customer Information

Buyer: Town of Surfside 9293 Harding Ave Surfside, FL 33154	Bill To: Town of Surfside 9293 Harding Ave Surfside, FL 33154	Ship To: Town of Surfside 9293 Harding Ave Surfside, FL 33154
--	--	--

(786) 778-1728
hgomez@townofsurfsidefl.gov

Shipping and Delivery Notes:
Standard shipping is dock-to-dock and does not include lift-gate, inside delivery, or other special services and assumes the use of a 53' delivery truck. Please let us know if you have special delivery requirements.

Lead time for these containers is : **4 - 6 Weeks**

Quote #0048642

ACCOUNT REP Amanda Gilbert

QUOTE DATE	QUOTE AMOUNT	QUOTE EXPIRES
June 2, 2020	\$47,820.00	July 3, 2020

ITEM CODE	QTY	DESCRIPTION	UNIT PRICE	TOTAL
VANCOUVER - SINGLE - CANOPY - BLACK, VANCOUVER - SINGLE - CANOPY - BLUE	30.00	The Vancouver Trash & Recycling Bin Combo with Canopy Website price \$1,790	\$1,594.00	\$47,820.00
			<i>Subtotal</i>	\$47,820.00
			<i>Tax</i>	\$
			<i>Shipping</i>	\$1712.00
			Total	\$49,532.00

- To approve your quote via **FAX**: Print, Sign and Fax this page to **888.506.0210**
- To approve your quote via **USMail**: Print, Sign and Mail this page to **Recycle Away, 35 Frost Street, Brattleboro, VT 05301**
- To approve your quote via **Email**, fill out download to us at **sales@recycleaway.com**

Signature: _____

Email: _____

Company: _____

PO# (Optional): _____

Credit Card# (Optional): _____

Exp. / / 3-digit-code: _____

Damages & Returns

Damages - All shipments are insured against damage in transit. If your shipment shows any sign of visual damage, it should be noted on the freight bill or receiving ticket and signed by the driver. If damage to the shipment is not visible until the carton is opened, please keep all of the packing materials and the original carton. In either case, please notify Recycle Away within five days.

Returns - If your order is damaged in shipment, we will either issue credit for the product and the shipping costs, or ship a replacement product at no cost for the product and shipping. If you need to return the purchase for any other reason please notify us within five days. Please note that special orders are non-refundable. The customer must pay for the return shipping and a re-stocking fee of 25, for returned items. The items must be returned in their original cartons in new condition.

35 Frost Street | Brattleboro, VT 05301 | Tel : 800.664.5340 | Fax: 888.506.0210 | Email: sales@recycleaway.com