



**Town of Surfside
Regular Town Commission Meeting
AGENDA
July 14, 2020
7 p.m.**

Town Hall Commission Chambers - 9293 Harding Ave, 2nd Floor
Surfside, FL 33154

1. Opening

- A. Call to Order**
- B. Roll Call of Members**
- C. Pledge of Allegiance**
- D. Mayor and Commission Remarks – Mayor Charles W. Burkett**
- E. Agenda and Order of Business Additions, deletions and linkages**
- F. Community Notes – Mayor Charles W. Burkett**
- G. Presentation of the CAFR Report – Jason Greene, Interim Assistant Town Manager**
- H. Appointment of Interim Town Manager – Mayor Charles W. Burkett**

2. Quasi-Judicial Hearings

- A. Surf Club Site Plan – 9133-9149 Collins Avenue Jason Greene, Interim Assistant Town Manager (Pages 1-63)**

A RESOLUTION OF THE TOWN COMMISSION OF THE TOWN OF SURFSIDE, FLORIDA, [APPROVING/ DENYING] A REQUEST TO EXTEND SITE PLAN AND CONDITIONAL USE APPROVAL GRANTED BY RESOLUTION NO. 18-2489 FOR THE PROPERTY LOCATED AT 9133-9149 COLLINS AVENUE, SURFSIDE, FLORIDA (THE “PROPERTY”); CLARIFYING EFFECTIVENESS OF ORIGINAL TERMS AND CONDITIONS; AND PROVIDING FOR AN EFFECTIVE DATE.

- 3. Consent Agenda (Set for approximately 7:30 p.m.)** *All items on the consent agenda are considered routine or status reports by the Town Commission and will be approved by one motion. Any Commission member may request that an item be removed from the Consent Agenda and discussed separately. If the public wishes to speak on a matter on the consent agenda they must inform the Town Clerk prior to the start of the meeting. They will be recognized to speak prior to the approval of the consent agenda.*

A. Minutes – Sandra N. McCreedy, MMC, Town Clerk (Pages 64-139)

- June 3, 2020 Zoning Code Workshop Meeting Minutes
- June 9, 2020 Regular Town Commission Meeting Minutes
- June 18, 2020 Budget Workshop Minutes
- June 23, 2020 Special Town Commission Meeting Minutes
- July 1, 2020 Special Town Commission Meeting Minutes
- July 1, 2020 Zoning Code Workshop Minutes
- July 6, 2020 Joint Town Commission and Pension Board Meeting Minutes

***B. Town Manager’s Report** – Jason Greene, Interim Assistant Town Manager (Pages 140-175)

***C. Town Attorney’s Report** – Weiss Serota, Town Attorney (Pages 176-181)

D. Committee Reports – Jason Greene, Interim Assistant Town Manager – ***None at this time***

E. Resolution authorizing Mutual Aid Agreement between Bal Harbour Village and Town of Surfside – Jason Greene, Interim Assistant Town Manager (Pages 182-192)

A RESOLUTION OF THE TOWN COMMISSION OF THE TOWN OF SURFSIDE, FLORIDA, APPROVING A VOLUNTARY COOPERATION AND OPERATIONAL ASSISTANCE MUTUAL AID AGREEMENT WITH THE BAL HARBOUR VILLAGE, FLORIDA; PROVIDING FOR AUTHORIZATION; PROVIDING FOR IMPLEMENTATION; AND PROVIDING FOR AN EFFECTIVE DATE.

F. Resolution authorizing the Mutual Aid Agreement between the Town of Surfside and the School Board of Miami Dade County through the School Board Police - Jason Greene, Interim Assistant Town Manager (Pages 193-203)

A RESOLUTION OF THE TOWN COMMISSION OF THE TOWN OF SURFSIDE, FLORIDA, APPROVING A VOLUNTARY COOPERATION AND OPERATIONAL ASSISTANCE MUTUAL AID AGREEMENT WITH THE SCHOOL BOARD OF MIAMI DADE COUNTY, FLORIDA; PROVIDING FOR AUTHORIZATION; PROVIDING FOR IMPLEMENTATION; AND PROVIDING FOR AN EFFECTIVE DATE.

4. Ordinances

(Set for approximately N/A p.m.) (Note: Good and Welfare must begin at 8:15)

A. Second Reading Ordinances

(Set for approximately N/A p.m.) (Note: Good and Welfare must begin at 8:15)

B. First Reading Ordinances

5. Resolutions and Proclamations

(Set for approximately 9:00 p.m.) (Note: Depends upon length of Good and Welfare)

A. External Auditor Extension Resolution - Jason Greene, Interim Assistant Town Manager (Pages 222-239)

A RESOLUTION OF THE TOWN COMMISSION OF THE TOWN OF SURFSIDE, FLORIDA, APPROVING AN ENGAGEMENT LETTER WITH MARCUM LLP FOR FINANCIAL AUDITING SERVICES FOR FISCAL YEAR ENDING SEPTEMBER 30, 2020; PROVIDING FOR AUTHORIZATION; PROVIDING FOR IMPLEMENTATION; AND PROVIDING FOR AN EFFECTIVE DATE.

B. Amendment No. 3 Mental Health Agreement Form 2020-21 School Year - Jason Greene, Interim Assistant Town Manager (Pages 240-286)

A RESOLUTION OF THE TOWN COMMISSION OF THE TOWN OF SURFSIDE, FLORIDA APPROVING AMENDMENT NO. 3 TO THE MEMORANDUM OF UNDERSTANDING BETWEEN THE TOWN OF SURFSIDE, THE CITY OF MIAMI BEACH, NORTH BAY VILLAGE, TOWN OF BAY HARBOR ISLANDS, BAL HARBOUR VILLAGE, AND THE MIAMI BEACH CHAMBER EDUCATION FOUNDATION, INC. TO FUND A NURSE ENHANCEMENT INITIATIVE FOR SCHOOL YEAR 2020/2021 FOR RUTH K. BROAD BAY HARBOR K-8 CENTER; PROVIDING FOR AUTHORIZATION AND IMPLEMENTATION OF THE AMENDMENT TO THE MOU; AND PROVIDING FOR AN EFFECTIVE DATE.

C. Undergrounding Powerlines Ballot Question - Jason Greene, Interim Assistant Town Manager (Pages 287-298)

A RESOLUTION OF THE TOWN COMMISSION OF THE TOWN OF SURFSIDE, FLORIDA, CALLING FOR A TOWN OF SURFSIDE SPECIAL ELECTION TO BE HELD ON NOVEMBER 3, 2020 FOR THE PURPOSE OF SUBMITTING TO THE ELECTORATE A BALLOT QUESTION AS A NON-BINDING REFERENDUM CONCERNING UNDERGROUNDING OF UTILITIES; PROVIDING FOR NOTICE OF ELECTION; PROVIDING REQUISITE BALLOT LANGUAGE FOR SUBMISSION TO THE ELECTORATE; PROVIDING FOR THE TOWN CLERK TO UTILIZE THE SERVICES OF MIAMI-DADE COUNTY SUPERVISOR OF ELECTIONS FOR THE SPECIAL ELECTION; AND PROVIDING FOR AN EFFECTIVE DATE.

D. Solid Waste Services Special Assessment Preliminary Rate Resolution - Jason Greene, Interim Assistant Town Manager (Pages 299-310)

A RESOLUTION OF THE TOWN OF SURFSIDE, FLORIDA, RELATING TO SOLID WASTE MANAGEMENT SERVICES, INCLUDING COLLECTION, DISPOSAL AND RECYCLING OF RESIDENTIAL SOLID WASTE IN THE TOWN OF SURFSIDE, FLORIDA; ESTABLISHING THE ESTIMATED ASSESSMENT RATE FOR SOLID WASTE SERVICE ASSESSMENTS AGAINST ASSESSED PROPERTY LOCATED WITHIN THE TOWN OF SURFSIDE, FLORIDA, FOR THE FISCAL YEAR BEGINNING OCTOBER 1, 2020; DIRECTING THE PREPARATION OF AN UPDATED ASSESSMENT ROLL; AUTHORIZING A PUBLIC HEARING AND DIRECTING THE PROVISION OF NOTICE THEREOF; AND PROVIDING FOR AN EFFECTIVE DATE.

**6. Good and Welfare/ Public Comments from Residents
(Set for approximately 8:15 p.m.)**

Public comments for subjects or items not on the agenda. Public comment on agenda items will be allowed when agenda item is discussed by the Commission.

7. Town Manager and Town Attorney Reports

Town Manager and Town Attorney Reports have been moved to the Consent Agenda – Item 3.

8. Unfinished Business and New Business

9. Mayor, Commission and Staff Communications

A. COVID-19 Task Force Update – Mayor, Vice Mayor and Members of the Town

Commission

- B. Replacement Bins for Trash and Recycling Receptacles Throughout Town**
- Jason Greene, Interim Assistant Town Manager (Pages 311-348)
- C. New Zoning Code- Procedural and Notice Requirements** – Mayor Charles W. Burkett
- D. 92nd St Beach-end Improvements** - Mayor Charles W. Burkett (Pages 349-365)
- E. Rope Fencing & Posts-Beachwalk/Hardpack** - Mayor Charles W. Burkett
- F. Develop Capital Improvement Plan (CIP)** - Mayor Charles W. Burkett
- G. 10 Year Water Supply Plan** - Mayor Charles W. Burkett
- H. Various Parks & Recreation Related Events and Initiatives** – Mayor Charles W. Burkett
- I. Building Department File Digitization** – Mayor Charles W. Burkett
- J. Pinzur Communication** – Mayor Charles W. Burkett (Pages 366-372)
- K. Preservation of Eden Project located at 9300 Collins Avenue** - Mayor Charles W. Burkett
- L. Speeding on Collins and Harding** - Mayor Charles W. Burkett
- M. Amending Town Code Section 2-205 Conduct of Meetings; Agenda** – Mayor Charles W. Burkett (Pages 373-388)
- N. Homeless Contribution by the Town of Surfside of \$100,000** - Mayor Charles W. Burkett
- O. Free (hassle-free) downtown parking for residents** - Mayor Charles W. Burkett
- P. Charter Amendments to affirm the limit of pay for elected officials to a maximum of \$1 per year, term limits for elected officials of 3 consecutive terms, or any part thereof, for both Mayor & Commissioners, a prohibition on the sale or leasing of any Town property without a referendum & a prohibition against any loan or borrowing of any type, which would put the Town into debt for more than 10% of its annual property tax revenue and which could not be fully amortized within a total of 5 years and restore development protections in the charter-** Mayor Charles W. Burkett (Pages 389-391)
- Q. Records Retention Policy** – Mayor Charles W. Burkett
- R. Regulation of Short-Term Rentals** – Mayor Charles W. Burkett (Page 392)
- S. Star Cleaning Service (Street Sweeping)** – Mayor Charles W. Burkett (Pages 393-405)
- T. S.M.A.R.T Goals, Quality Control & Quality Assurance** – Commissioner Charles Kesl
- U. Design Review Board Discussion – Staff Report** – Jason Greene, Interim Assistant Town Manager (Pages 406-424)
- V. Weiss Serota Contract Follow up – Staff Report** – Jason Greene, Interim Assistant Town Manager (Pages 425-431)
- W. Town Pension Benefits for Non-Public Safety Employees** – Mayor Charles

- W. Burkett (Pages 432-504)
- X. **Additional lighting in the residential area – Staff Report** – Jason Greene, Interim Assistant Town Manager (Pages 505-533)
- Y. **Construction Guidelines for Hurricane Season** – Commissioner Nelly Velasquez
- Z. **Lowering of Property Taxes and Water Bills – Staff Report** – Jason Greene, Interim Assistant Town Manager (Pages 534-571)
- AA. **CGA Contract Follow Up – Staff Report** – Jason Greene, Interim Assistant Town Manager (Pages 572-579)
- BB. **Discussion Regarding Appointments to Committees and Boards** – Sandra N. McCready, Town Clerk
- CC. **Downtown Lighting RFP (Commission deferred to Downtown Vision Advisory Committee (DVAC))** – Mayor Charles W. Burkett
- DD. **Dog Park** – Mayor Charles W. Burkett (Pages 580-581)
- EE. **FPL Solar Together** - Vice Mayor Tina Paul (Pages 582-585)
- FF. **Climate Environmental Collective - Revised** - Vice Mayor Tina Paul (Pages 586-587)
- GG. **Interest Free Loans to Surfside Builders Granted by Former Mayor and Commission** – Mayor Charles W. Burkett (Pages 588-599)
- HH. **How our Zoning Protections Against Over-Development Were Gutted** - Mayor Charles W. Burkett
- II. **Amending Town Code Section 2-233 to Include Non-for-Profit** – Mayor Charles W. Burkett
- JJ. **Amending Town Code Section 2-237 Business Relationships** – Commissioner Eliana Salzhauer
- KK. **Speeding & Stop Sign Running** - Commissioner Eliana Salzhauer
- LL. **Surfside Point Lake Subaqueous WM Crossing - Bid Documents** – Jason Greene, Interim Assistant Town Manager (Pages 600-654)
- MM. **Beachwalk Trimming- Staff Report** – Jason Greene, Interim Assistant Town Manager (Page 655)
- NN. **Pool Deck Lighting for Extended Winter Hours- Staff Report** – Jason Greene, Interim Assistant Town Manager (Page 656)
- OO. **Community Center Second Floor – Staff Report** - Jason Greene, Interim Assistant Town Manager (Page 657)
- PP. **Repeal of Ordinance No. 17-1662 Beach Furniture** – Mayor Charles W. Burkett (Pages 658-665)
- QQ. **Designated (Painted) Walking Areas in the Residential District- Staff Report** – Jason Greene, Interim Assistant Town Manager (Pages 666-668)
- RR. **Procurement Expertise** – Commissioner Eliana Salzhauer
- SS. **Take Home Vehicles** - Commissioner Eliana Salzhauer
- TT. **Recent and Significant Increase in Boat, Paddleboard and Kayak Use on Point Lake** – Mayor Charles W. Burkett

- UU. Comparison of 2006 Code to 2020 Code – Staff Report** – Jason Greene, Interim Assistant Town Manager (Pages 669-673)
- VV. Stormwater Masterplan - Staff Report** – Jason Greene, Interim Assistant Town Manager (Pages 674-675)
- WW. Securing Power Infrastructure: Timely Action Plan for Hurricane Season through accountability now by FPL, ATT and Atlantic Broadband – Staff Report** – Jason Greene, Interim Assistant Town Manager
- XX. Amendment to the Tourist Board Ordinance** – Commissioner Nelly Velasquez
- YY. Demolition by Neglect** - Mayor Charles W. Burkett (Pages 676-677)
- ZZ. Discussion and Action on Ballot Language for Undergrounding of Utilities** - Commissioner Eliana Salzhauer
- AAA. Discussion and Action Regarding Newly Implemented “Town Blog”, Surfside Gazette and Social Media Guidelines** – Commissioner Eliana Salzhauer
- BBB. Potential Ballot Question - P3/Lease or Sale of Town Property** – Commissioner Eliana Salzhauer (Pages 678-679)
- CCC. Draft Ordinance Amending Definitions of Lot Coverage** - Commissioner Eliana Salzhauer (Pages 680-683)
- DDD. Zoning Rewrite “Acre” vs. “Gross Acre”** - Commissioner Eliana Salzhauer

Thirty (30) Day Staff Report– Items from June 23, 2020 Special Town Commission Meetings

- A. Brightview Agreement (FKA Luke’s Landscape) Report and Follow up– Staff Report** – Jason Greene, Interim Assistant Town Manager
- B. Miami Christmas Lights** – Jason Greene, Interim Assistant Town Manager

Items Completed or Removed from Previous Agendas

- A. Resolution Adopting an Amended Resiliency Reserve Policy Revision**
- B. Resolution Approving the March 17, 2020 Town of Surfside Municipal Election**
- C. Resolution Abolishing the Sustainability and Resiliency Committee**
- D. Resolution Amending the Downtown Vision Advisory Committee**
- E. Resolution Reauthorizing the Parks and Recreation Committee**
- F. “Flash Your Lights”** - Commissioner Eliana Salzhauer

- G. Mandatory Face Mask in the Town of Surfside** – Commissioner Nelly Velasquez
- H. Bandanas for Town Residents** – Commissioner Eliana Salzhauer
- I. Commission Meeting Starting Time at 6:00pm** – Mayor Charles W. Burkett
- J. Discussion Regarding Assistant Town Manager position and Action** - Commissioner Nelly Velasquez
- K. Photovoltaic RFP** - Mayor Charles W. Burkett
- L. Facilities Review** - Mayor Charles W. Burkett
- M. Kayak Launch** - Mayor Charles W. Burkett
- N. Jacober Contract** – Mayor Charles W. Burkett
- O. Zambelli Fireworks Manufacturing** - Mayor Charles W. Burkett
- P. Small Business Survival Grant** - Vice Mayor Tina Paul
- Q. Review of Amendment No. 2 to Update No. 5 Town of Surfside Emergency Measures** – Vice Mayor Tina Paul
- R. Downtown Surfside Sidewalk Beautification - Plans and Studies** - Mayor Charles W. Burkett [*Downtown Vision Advisory Committee to discuss*]
- S. Sidewalk on N 95th St between Abbott and Byron** - Mayor Charles W. Burkett
- T. Beach Raking** – Mayor Charles W. Burkett
- U. Community Digital Signs** – Mayor Charles W. Burkett
- V. Government Academy** - Mayor Charles W. Burkett
- W. Various Tourism Related Events, Initiatives, and Destination Marketing** - Mayor Charles W. Burkett
- X. Classification and Compensation Study** – Mayor Charles W. Burkett
- Y. Flooding/Drainage Improvements** – Jason Greene, Interim Assistant Town Manager
- Z. Abbott Avenue Drainage Improvements** – Commissioner Nelly Velasquez
- AA. Downtown Surfside Sidewalk Beautification - Plans and Studies** - Mayor Charles W. Burkett – *Referred to DVAC*
- BB. Police Body-Worn Camera System** – Commissioner Nelly Velasquez
- CC. Care ACT Fund** – Jason Greene, Interim Assistant Town Manager
- DD. FY 2020 Budget Amendment** – Jason Greene, Interim Assistant Town Manager
- EE. Purchase of Additional Sewer Pump** – Jason Greene, Interim Assistant Town Manager
- FF. Planning and Zoning Board Membership Requirements Ordinance** – Jason Greene, Interim Assistant Town Manager
- GG. Tourist Board Membership Requirement Ordinances**– Jason Greene, Interim Assistant Town Manager

- HH. Resolution Renaming the Town’s Higher Education Scholarships to be called the “Arya Gray Memorial Higher Education Scholarship” –**
Commissioner Eliana Salzhauer
- II. Interlocal Shuttle System Report Update –** Guillermo Olmedillo, Town Manager
- JJ. Reconsideration of the Installation of Berms on 92nd Street -** Vice Mayor Tina Paul
- KK. Staffing Hiring Freeze –** Commissioner Eliana Salzhauer
- LL. Undergrounding power lines – Staff Report –** Jason Greene, Interim Assistant Town Manager
- MM. Streamline Town Staffing –** Commissioner Eliana Salzhauer

10. Adjournment

Respectfully submitted,



Guillermo Olmedillo
Town Manager

THIS MEETING IS OPEN TO THE PUBLIC. IN ACCORDANCE WITH THE AMERICANS WITH DISABILITIES ACT OF 1990, ALL PERSONS THAT ARE DISABLED; WHO NEED SPECIAL ACCOMMODATIONS TO PARTICIPATE IN THIS MEETING BECAUSE OF THAT DISABILITY SHOULD CONTACT THE OFFICE OF THE TOWN CLERK AT 305-861-4863 EXT. 226 NO LATER THAN FOUR DAYS PRIOR TO SUCH PROCEEDING.

IN ACCORDANCE WITH THE PROVISIONS OF SECTION 286.0105, FLORIDA STATUTES, ANYONE WISHING TO APPEAL ANY DECISION MADE BY THE TOWN OF SURFSIDE COMMISSION, WITH RESPECT TO ANY MATTER CONSIDERED AT THIS MEETING OR HEARING, WILL NEED A RECORD OF THE PROCEEDINGS AND FOR SUCH PURPOSE, MAY NEED TO ENSURE THAT A VERBATIM RECORD OF THE PROCEEDINGS IS MADE WHICH RECORD SHALL INCLUDE THE TESTIMONY AND EVIDENCE UPON WHICH THE APPEAL IS TO BE BASED.

AGENDA ITEMS MAY BE VIEWED AT THE OFFICE OF THE TOWN CLERK, TOWN OF SURFSIDE TOWN HALL, 9293 HARDING AVENUE. ANYONE WISHING TO OBTAIN A COPY OF ANY AGENDA ITEM SHOULD CONTACT THE TOWN CLERK AT 305-861-4863. A COMPLETE AGENDA PACKET IS ALSO AVAILABLE ON THE TOWN WEBSITE AT www.townofsurfsidefl.gov.

TWO OR MORE MEMBERS OF OTHER TOWN BOARDS MAY ATTEND THIS MEETING.

THESE MEETINGS MAY BE CONDUCTED BY MEANS OF OR IN CONJUNCTION WITH COMMUNICATIONS MEDIA TECHNOLOGY, SPECIFICALLY, A TELEPHONE CONFERENCE CALL. THE LOCATION 9293 HARDING AVENUE, SURFSIDE, FL 33154, WHICH IS OPEN TO THE PUBLIC, SHALL SERVE AS AN ACCESS POINT FOR SUCH COMMUNICATION.



Town of Surfside

Commission Communication

Agenda Date: July 14, 2020

Subject: Request for Extension of Surf Club II Site Plan
From: Guillermo Olmedillo, Town Manager
James Hickey, AICP, Town Planner

Table of Contents:

1. Agenda from February 13, 2018 approving site plan including
 - a. Staff Report
 - b. Site Plan Report
 - c. Development Impact Committee Report
 - d. Office of Historic Preservation Approval
 - e. Conditional Use Report
 - f. Application and Letter of Intent
 - g. Site Plan Package
2. Resolution 18-2489
3. Letter dated February 12, 2020 Requesting to Extend Date of Site Plan Approval
4. Letter dated June 10, 2020 Requesting to Place Item on Next Available Commission Agenda
5. Letter dated April 29, 2020 from Office of Historic Preservation Extending Approval

REQUEST:

The agent, Ian DeMello, Esq., for the owner, The Surf Club Apartments, Inc. and The Seaway Villas Condominium Association, Inc., (known as Surf Club II) is requesting a one-year extension of their site plan approval. The site plan consists of 48 condominium units, 31 hotel rooms, along with a 1,100 square-foot restaurant and lounge. A conditional use approval for hotel swimming pools and outdoor dining was also part of the application. The application was considered and approved by the Town Commission on February 13, 2018 through the adoption of Resolution 18-2489. Per Section 90-23.3(1) of the Zoning Code, the Town Commission can grant a one-year extension of a site plan approval for good cause and at its sole discretion. On February 12, 2020, the agent submitted a letter to the Town Manager requesting a one-year extension.

BACKGROUND:

The approved site plan consists of a 12-story tower located at 9133-9149 Collins Avenue and is proposed to include 48 new condominium units as well as 31 hotel rooms. The site plan includes a 1,100 square-foot restaurant and lounge. As part of the project received conditional use approval for hotel swimming pools and outdoor dining as they are accessory to the hotel use. The proposed tower will include 46 new condominium units and 31 hotel rooms. The approval includes a proposal to renovate a historic structure known as Seaway Villas and incorporate the building into the site plan. The Seaway Villas portion of the property will include two additional dwelling units as well as the lounge and restaurant. The site plan, through coordination with the Miami-Dade Historic Preservation Board, will include setting back the existing façade to provide a drop off area and landscaping.

The total gross acreage of the site is 2.16 acres, which would permit 234 units. The code requires a 15% reduction in density for aggregated properties, meaning, if a property is split between more than one site and the owner wants the benefit of amalgamating that property, the property will be subject to a 15% overall density reduction. This results in the permitted density of 199 units. The applicant is requesting to add 46 new condominium units and 31 hotel rooms. The project also proposes to demolish 30 existing units at the Surf Club Apartments and to renovate and remove some units at the Seaway Villas. Currently, the Seaway Villas has 28 units and the renovations will result in two units on this portion of the site. The project requires no variances from Town Code requirements and with the demolition of the Surf Club apartments, renovation of Seaway Villas, the 12-story tower the total number of condominium units proposed is 48 units and 31 hotel rooms. The prior site contained 58 units.

The proposed project replaces 60,641 square feet of residential, known as the Surf Club apartments, with 302,000 square feet of condominium and hotel units. The Seaway building is not included in this calculation as the square footage is being slightly reduced, but the building will remain. Analysis of the site plan and conditional use can be found in the February 13, 2018 staff memorandum which is attached.

The Development Impact Committee (DIC) met in an open, advertised, televised sessions on July 27, 2016 and September 28, 2017. The applicant prepared an analysis of other Miami-Dade jurisdictions impact fees which equaled an estimated fee of \$165,000, if the Town had impact fees. The total proposed voluntary contribution by the applicant is \$250,000 for the project.

The Planning and Zoning Board reviewed this application at their January 25, 2018 Planning and Zoning Board meeting and requested that the applicant revisit the driveway at the Seaway to see if it is possible to be removed. However, that would impact the traffic circulation. The Board also requested that the applicant consider adding additional valets if there are queuing issues on Collins Avenue.

There was a previous site plan submitted on August 12, 2015. The application included 54 condominium units with no hotel component and was proposed as an 11-story, 120-foot high building. Development Review Group (DRG) meetings were held on September 4, 2015 and April 18, 2016. The Planning and Zoning Board heard the application on August 26, 2016 where it was unanimously recommended for approval. The applicant decided not to move forward with this design and resubmitted a new application that was ultimately approved by the Town Commission on February 13, 2018.

MIAMI DADE HISTORIC PRESERVATION BOARD

The Miami-Dade Historic Preservation Board heard the site plan application for the Surf Club II, including the Seaway Villas on September 21, 2016 and again on May 17, 2017. The Staff to the Miami-Dade Historic Preservation Board are recommending approval of the application due to the full restoration of the Seaway Villas including the landscaped courtyard, which is an integral feature of the historic building. The conditions imposed by the Miami-Dade Historic Preservation Board were incorporated by reference I. The applicant has provided a letter from Miami-Dade's Office of Historic Preservation extending their approval date to May 17, 2021.

STAFF RECOMMENDATION

Recommendation: Staff recommends that the Town Commission consider the extension of this site plan approval with the conditional use approval to February 13, 2021.

Budget Impact: The applicant is proposing a \$250,000, voluntary proffer to mitigate off-site impacts resulting from the project.

Growth Impact: The project includes 46 new condominium units and two renovated units for a total of 48 condominium units as well as 31 hotel rooms. The existing site has 58 units, resulting in a total of 10 more units than exist on site as well as 31 new hotel units. However, the property has a maximum density permitted of 199 units. Therefore, the traffic impacts are accounted for within the Comprehensive Plan. Other impacts could be offset by the voluntary proffer.

Staff Impact: The applicant has funded the review through the cost recovery process and the building permit review will be funded through the building permit fees.



James Hickey, AICP, Town Planner

Guillermo Olmedillo, Town Manager

**AGENDA AND REPORT FROM
FEBRUARY 13, 2018
TOWN COMMISSION MEETING**



**Town of Surfside
Special Town Commission Meeting
Quasi-Judicial Hearing
AGENDA
February 13, 2018
6:00 p.m.**

Town Hall Commission Chambers - 9293 Harding Ave, 2nd Floor
Surfside, FL 33154

Rule 7.05 Decorum. Any person making impertinent or slanderous remarks or who becomes boisterous while addressing the commission shall be barred from further appearance before the commission by the presiding officer, unless permission to continue or again address the commission is granted by the majority vote of the commission members present. No clapping, applauding, heckling or verbal outbursts in support or opposition to a speaker or his or her remarks shall be permitted. Signs or placards may be disallowed in the commission chamber by the presiding officer. Persons exiting the commission chambers shall do so quietly.

Any person who received compensation, remuneration or expenses for conducting lobbying activities is required to register as a lobbyist with the Town Clerk prior to engaging in lobbying activities per Town Code Sec. 2-235. "Lobbyist" specifically includes the principal, as defined in this section, as well as any agent, officer or employee of a principal, regardless of whether such lobbying activities fall within the normal scope of employment of such agent, officer or employee. The term "lobbyist" specifically excludes any person who only appears as a representative of a not-for-profit corporation or entity (such as charitable organization, a trade association or trade union), without special compensation or reimbursement for the appearance, whether direct, indirect, or contingent, to express support or opposition to any item.

Per Miami Dade County Fire Marshal, the Commission Chambers has a maximum capacity of 99 people. Once reached this capacity, people will be asked to watch the meeting from the first floor.

1. Opening

- A. Call to Order
- B. Roll Call of Members
- C. Pledge of Allegiance

2. Quasi-Judicial Hearings

Please be advised that the following items on the Agenda are Quasi-Judicial in nature. If you wish to object or comment upon an item, please complete a Public Speaker 's Card indicating the agenda item number on which you would like to comment. You must be sworn before addressing the Town Commission and you may be subject to cross-examination. If you refuse to submit to cross-examination, the Town Commission will not consider your comments in its final deliberation. Please also disclose any Ex-Parte communications you may have had with any members of the Town Commission. Town Commission members must also do the same.

A. 9133-9149 Collins Avenue – Guillermo Olmedillo, Town Manager

**A RESOLUTION OF THE TOWN COMMISSION OF SURFSIDE, FLORIDA;
APPROVING A SITE PLAN APPLICATION FOR PROPERTY GENERALLY
LOCATED AT 9133-9149 COLLINS AVENUE, SURFSIDE, FL, FOR
DEVELOPMENT CONSISTING OF 48 CONDOMINIUM UNITS, 31 HOTEL
ROOMS, AND AN 1,100 SQUARE FOOT RESTAURANT AND LOUNGE; AND
PROVIDING CONDITIONAL USE APPROVAL FOR THE HOTEL
SWIMMING POOLS AND OUTDOOR DINING INCLUDED IN THE SITE
PLAN; AND PROVIDING FOR A SEVERABILITY CLAUSE AND AN
EFFECTIVE DATE.**

3. Adjournment

Respectfully submitted,

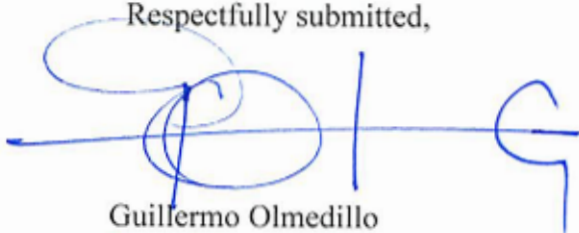
A handwritten signature in blue ink, appearing to read 'G. Olmedillo', written over a horizontal line.

Guillermo Olmedillo
Town Manager

THIS MEETING IS OPEN TO THE PUBLIC. IN ACCORDANCE WITH THE AMERICANS WITH DISABILITIES ACT OF 1990, ALL PERSONS THAT ARE DISABLED; WHO NEED SPECIAL ACCOMMODATIONS TO PARTICIPATE IN THIS MEETING BECAUSE OF THAT DISABILITY SHOULD CONTACT THE OFFICE OF THE TOWN CLERK AT 305-861-4863 EXT. 226 NO LATER THAN FOUR DAYS PRIOR TO SUCH PROCEEDING.

IN ACCORDANCE WITH THE PROVISIONS OF SECTION 286.0105, FLORIDA STATUTES, ANYONE WISHING TO APPEAL ANY DECISION MADE BY THE TOWN OF SURFSIDE

COMMISSION, WITH RESPECT TO ANY MATTER CONSIDERED AT THIS MEETING OR HEARING, WILL NEED A RECORD OF THE PROCEEDINGS AND FOR SUCH PURPOSE, MAY NEED TO ENSURE THAT A VERBATIM RECORD OF THE PROCEEDINGS IS MADE WHICH RECORD SHALL INCLUDE THE TESTIMONY AND EVIDENCE UPON WHICH THE APPEAL IS TO BE BASED.

AGENDA ITEMS MAY BE VIEWED AT THE OFFICE OF THE TOWN CLERK, TOWN OF SURFSIDE TOWN HALL, 9293 HARDING AVENUE. ANYONE WISHING TO OBTAIN A COPY OF ANY AGENDA ITEM SHOULD CONTACT THE TOWN CLERK AT 305-861-4863. A COMPLETE AGENDA PACKET IS ALSO AVAILABLE ON THE TOWN WEBSITE AT www.townofsurfsidefl.gov.

TWO OR MORE MEMBERS OF OTHER TOWN BOARDS MAY ATTEND THIS MEETING.

THESE MEETINGS MAY BE CONDUCTED BY MEANS OF OR IN CONJUNCTION WITH COMMUNICATIONS MEDIA TECHNOLOGY, SPECIFICALLY, A TELEPHONE CONFERENCE CALL. THE LOCATION 9293 HARDING AVENUE, SURFSIDE, FL 33154, WHICH IS OPEN TO THE PUBLIC, SHALL SERVE AS AN ACCESS POINT FOR SUCH COMMUNICATION.



Town of Surfside

Commission Communication

Agenda Date: February 13, 2018

Subject: Surf Club II Site Plan
From: Guillermo Olmedillo, Town Manager
Sarah Sinatra Gould, AICP, Town Planner

Table of Contents:

1. Site Plan Report
2. Development Impact Committee Report
3. Office of Historic Preservation Approval
4. Conditional Use Report
5. Application and Letter of Intent
6. Site Plan Package

REQUEST:

The agent, Alexander Tachmes, Esq., for the owner, The Surf Club Apartments, Inc. and The Seaway Villas Condominium Association, Inc., is proposing a site plan to develop a 12 story tower located at 9133-9149 Collins Avenue. The proposed tower will include 46 new condominium units and 31 hotel rooms. The applicant is also proposing to renovate a historic structure known as Seaway Villas and incorporate the building into the site plan. The Seaway Villas portion of the property will include two additional dwelling units as well as a lounge and restaurant. The total number of condominium units will be 48.

The initial site plan application was submitted on August 12, 2015. The original application included 54 condominium units with no hotel component and was proposed to be an 11 story, 120 foot high building. Staff confirmed that the package was complete and scheduled a Development Review Group (DRG) meeting for September 4, 2015. The members of DRG include Planning, Engineering, Landscape Architecture, Survey, Traffic Engineering, Police, Town Administration and Building. Comments were provided to the applicant at this meeting and the applicant revised the site plan. A second DRG meeting was held on April 18, 2016. Comments were provided to the applicant at that time. The plans were resubmitted on June 13, 2016 and staff confirmed the plans met the technical comments. The Planning and Zoning Board heard the application on August 26, 2016 where it was unanimously recommended for approval.

Since that time, the applicant has added one floor to provide a 12 story building; however the height of 120 feet remains the same as the original application. The applicant also, through coordination with the Historic Preservation Board, is proposing to setback the existing façade to provide a drop off area and landscaping. The remainder of the changes affects the interior uses, which added 31 hotel rooms, reduced the historic structure's units from 16 to two, added a 1,100 square foot restaurant and lounge to the historic structure and reduced the new condominium units from 54 to 46.

The Development Impact Committee (DIC) met in an open, advertised, televised session on July 27, 2016 and again on September 28, 2017 to discuss this application. The applicant prepared an analysis of other Miami-Dade jurisdictions impact fees. The results of that analysis equaled an estimated fee of \$165,000, if the Town had impact fees. The applicant indicated they understood they are selling premium units and therefore would proffer more than \$165,000. The total proposed voluntary contribution by the applicant is \$250,000 for the project.

The total gross acreage of the site is 2.16 acres, which would permit 234 units. The code requires a 15% reduction in density for aggregated properties, meaning, if a property is split between more than one site and the owner wants the benefit of amalgamating that property, the property will be subject to a 15% overall density reduction. This results in the permitted density of 199 units. The applicant is requesting to add 46 new condominium units and 31 hotel rooms. The project also proposes to demolish 30 existing units at the Surf Club Apartments and to renovate and remove some units at the Seaway Villas. Currently, the Seaway Villas has 28 units and the renovations will result in two units on this portion of the site. The project requires no variances from Town Code requirements and with the demolition of the Surf Club apartments, renovation of Seaway Villas, the 12 story tower the total number of condominium units proposed is 48 units and 31 hotel rooms. The prior site contained 58 units.

The proposed project replaces 60,641 square feet of residential, known as the Surf Club apartments, with 302,000 square feet of condominium and hotel units. The Seaway building is not included in this calculation as the square footage is being slightly reduced, but the building will remain.

It should be noted that this application was submitted prior to the code modification that required setbacks to be 10% of the frontage of the site. However, the applicant is providing setbacks for the proposed building that meet or exceed this requirement.

The Planning and Zoning Board reviewed this application at their January 25, 2018 Planning and Zoning Board meeting and requested that the applicant revisit the driveway at the Seaway to see if it is possible to be removed. However, that would impact the traffic circulation. The Board also requested that the applicant consider adding additional valets if there are queuing issues on Collins Avenue.

MIAMI DADE HISTORIC PRESERVATION BOARD

The Miami-Dade Historic Preservation Board heard the site plan application for the Surf Club II, including the Seaway Villas on September 21, 2016 and again on May 17, 2017. The Staff to the Miami-Dade Historic Preservation Board are recommending approval of the application due to the full restoration of the Seaway Villas including the landscaped courtyard, which is an integral feature of the historic building. The conditions imposed by the Miami-Dade Historic Preservation Board shall be incorporated by reference in the Town's proposed resolution.

STAFF RECOMMENDATION

Recommendation: Staff recommends that the Town Commission approve the site plan and conditional use application based on the acceptance of the Development Conditions.

Budget Impact: The applicant is proposing a \$250,000, voluntary proffer to mitigate off-site impacts resulting from the project.

Growth Impact: The project includes 46 new condominium units and two renovated units for a total of 48 condominium units as well as 31 hotel rooms. The existing site has 58 units, resulting in a total of 10 more units than exist on site as well as 31 new hotel units. However, the property has a maximum density permitted of 199 units. Therefore, the traffic impacts are accounted for within the Comprehensive Plan. Other impacts could be offset by the voluntary proffer.

Staff Impact: The applicant has funded the review through the cost recovery process and the building permit review will be funded through the building permit fees.



Sarah Sinatra Gould, AICP, Town Planner



Guillermo Olmedillo, Town Manager

SITE PLAN REPORT

SITE PLAN INFORMATION:

Address	9139-9149 Collins Avenue
General Location	East side of Collins Avenue and 91 st Street.
Property Size	2.16 gross acres
Zoning District	H120
Adjacent Zoning Districts	H120 to the north and south, H40 to the west
Future Land Use	High Density Residential/Tourist
Density Permitted	109 units per acre X 2.16 acres =234 units reduced by 15% for aggregated lots TOTAL PERMITTED: 199
Number of units proposed	46 new dwelling units 2 existing dwelling units (historic building renovation) 31 hotel rooms TOTAL PROPOSED: 48 condominium units, 31 hotel rooms
Number of parking spaces	TOTAL Provided: 127 spaces TOTAL Required: 127 spaces

ZONING CODE, APPLICABLE REQUIREMENTS

Sec. 90.42

Minimum Unit Sizes	Minimum Required	Proposed	Number of Units
One-bedroom	800 square feet	1,100 square feet	31
Two-bedroom	950 square feet	1,300 square feet	4
Three-bedroom	1150 square feet	2,300 square feet	10
Four-bedroom	N/A	3,500 square feet	3
Total			48

Sec. 90.43

Maximum Building Heights	Maximum Required	Proposed
H120	120 feet maximum	120 feet

Sec. 90.44

Modification of Height	Maximum Permitted		Proposed	Must be of high architectural quality integral to the design of the building
H120	20ft	30% of roof area	20 feet	The mechanical equipment, rooftop decks and parapet walls meet these criteria.

Sec. 90.45(b)

Setbacks	Minimum Required		Proposed
H120	Front (Collins Avenue)	40 feet	42 feet, new building. 26 feet 9 inches, historic building
	Rear (Beach)	30feet	134 feet 9 inches
	Setback from platted bulkhead line	20 feet	21 feet 8 inches
	Side (south)	20 feet	25 feet
	Side (north)	10 feet	71 feet 8 inches

Sec. 90.47

Yards generally, allowable projections	Required	Proposed
H120 - Projections of balconies features into required yards	Maximum 8 feet for front, secondary and rear and 5 feet for interior side	Balconies do not encroach into setbacks.

Sec. 90.47.8

Cantilevered Canopy	Required	Proposed
Cantilevered canopy will be permitted in the required front yard, subject to the following	Must be completely supported (cantilevered) from the main structure	Complies
	Minimum 65% transparent	Complies
	Maximum frontage of 30 feet in width	30 feet proposed
	Maximum 20 foot extension into front setback	Extends 20 feet into setback
	Shall not extend into any side setback area	Does not extend into side setback area

Sec. 90.49

Lot Standards	Required	Proposed
Minimum Lot width	50 feet	250.34 feet
Minimum Pervious area	20%	46.6%

Sec. 90.50.1(2)

Architecture	Required	Proposed
All elevations for new structures and multi-story additions (additions greater than fifteen (15) feet in height)	Minimum of 10% wall openings including windows, doors or transitional spaces defined by porches, porticoes or colonnades.	Exceeds 10% wall openings
Roof materials are limited as follows:	<ul style="list-style-type: none"> a. Clay Tile; or b. White concrete tile; or c. Solid color cement tile which color is impregnated with the same color intensity throughout, provided said color if granted approval by the Design Review Board; d. Architecturally embellished metal if granted approval by the Design Review Board; or e. Other Florida Building Code approved roof material(s) if granted approval by the Design Review Board. 	A flat roof with a deck is proposed.

Sec. 90.50.2 (3)

Roof Deck Provisions	Required	Proposed
Roof Decks are limited to	a. Maximum 70% of the aggregate roof area;	70%
	b. Shall not exceed the maximum roof height required by any abutting property's zoning designation;	120 feet
	c. Minimum setback of 10 feet from the roofline on all sides	11 feet, 4 inches

Sec. 90.51(1)

Maximum frontage of buildings	Required	Proposed
H120	Continuous building wall frontages shall not exceed 150 feet	The proposed new building is 137 feet 10 inches.

Sec. 90.67.2

	Required	Proposed
Underground utilities	All utilities including telephone, cable, and electrical systems shall be installed underground.	The lines will be installed underground and have developed their landscaping plans accordingly.

Sec. 90.77(c)

	Minimum Required	Proposed
Off-Street Parking	(1.5 X 31- 1 bedroom) = 46.5 spaces (2.0 X 14- 2-3 bedroom) = 28 spaces (2.25 X 3- 4 bedroom) = 6.75 spaces Restaurant 1,100/100 = 11 spaces Hotel – 1 x 31 = 31 Total required: 124 Spaces	Total provided: 127 Spaces

Sec. 90.83

Off-Street Loading	Minimum Required	Proposed
Multifamily	1 space on site	1 space on site

Sec. 90.91

Vegetative Provisions	Minimum Required	Proposed
Xeriscape in pervious area	50%	73% on groundcover, 27% on sod

Sec. 90.91.2

Buffers	
Landscape buffer adjacent to streets and abutting properties	Application meets or exceeds all requirements.

Sec. 90.93

Open Space	
Landscaping along all buildings and structures, shrubs and trees required in open space	Application meets or exceeds all requirements.

DEVELOPMENT IMPACT COMMITTEE REPORT

DEVELOPMENT IMPACT COMMITTEE MEETING

The Development Impact Committee (DIC)* met on Wednesday, July 27, 2016 to discuss the application for the Surf Club II ("the Project"). The DIC meeting was attended by the following:

Staff Attendees: Guillermo Olmedillo, Town Manager
Joe Kroll, Public Works Director
Linda Miller, Town Attorney
Jane Graham, Assistant Town Attorney
Nancy Stroud, Consulting Attorney
Sarah Sinatra Gould, Town Planner
David Allen, Police Chief
Duncan Tavares, TEDACS Director
Ross Prieto, Building Official
Bill Tesauro, Landscape

Applicant Attendees:
Joe Benton, Fort Capital
Mathieu Picard, Kobi Karp Architects
Jason Nunez, Fernando Wong
Alex Tachmes, Shutts and Bowen

Citizen Attendees (who signed in): None

The Development Impact Committee (DIC)* met again on September 27, 2017 to discuss the application for the Surf Club II ("the Project"). The DIC meeting was attended by the following:

Staff Attendees: Guillermo Olmedillo, Town Manager
Randy Stokes, Public Works Director
Kathy Mehaffey, Town Attorney's Office
Sarah Sinatra Gould, Town Planner
David Allen, Police Chief
Duncan Tavares, Assistant Town Manager
Ross Prieto, Building Official
Bill Tesauro, Landscape
Eric Czerniejewski, Traffic Engineer

Applicant Attendees:
Joe Benton, Fort Capital
Mathieu Picard, Kobi Karp Architects
Jason Nunez, Fernando Wong
Maurizio Bravo, Kobi Karp Architects
Alex Tachmes, Shutts and Bowen

Citizen Attendees (who signed in): None

No additional conditions were suggested as a part of this application.

***NOTE:** The DIC meetings are televised on the Town's Channel 77 and are well on the Town's website and posted on Town Hall.

The applicant proffered \$250,000 to the Town to offset impacts from the project. The fee is based on their analysis of other Miami-Dade jurisdictions impact fees. This resulted in an average fee of \$165,000 for the buildings square footage and units. The applicant indicated it understood it was selling premium units and therefore would also proffer the additional amount from the average for a total voluntary contribution \$250,000 for the project.

OFFICE OF HISTORIC PRESERVATION APPROVAL

May 18, 2017

Seaway Condo Acquisitions LLC
176 NE 43 Street
Miami, FL 33137

RE: Seaway Villas, 9149 Collins Avenue, Surfside, Special COA #2017-09-S

Dear Property Owner:

On May 17, 2017, the Miami-Dade County Historic Preservation Board held a public hearing to review the Special Certificate of Appropriateness, COA #2017-09-S, for the restoration and redevelopment of Seaway Villas. The Board unanimously voted to approve the application, with the following conditions:

1. The owner shall submit a revised planting plan to staff that does not obscure the Collins Avenue façade. Staff shall provide an administrative review of the revised plan prior to construction.
2. The owner shall reconstruct the missing arched chimney cap.
3. New paving in the courtyard shall be an oolitic limestone that matches the character and color of the existing limestone.
4. The owner shall provide information on the paving material proposed for the vehicular drop-off area between Collins Avenue and the structure. Staff shall provide an administrative review of the proposed material prior to installation.
5. The open-air entry/lobby area of the building shall retain its existing terracotta-colored tile.
6. The proposed awnings for the third-story open-air terraces shall be a dark, solid color with white scallop detail edging, as documented in historic period photos. Staff shall provide an administrative review of the proposed awnings prior to installation.
7. The owner shall submit requests for COA amendments if any changes or alterations from what has been presented in this application are proposed at any time through project completion. Staff shall provide administrative reviews of any such amendment requests prior to the construction of any such proposed revision.

8. If the intent to relocate the three-story, Collins Avenue-fronting portion of the building eastward by 13 feet is altered from what was presented in this application, due to any reason, the applicant shall reappear before this Board with a request to amend the COA approval.
9. The project shall include a public space to interpret, or "tell the story," of the history of Seaway Villas, particularly its context in the early history of Surfside.

The fee for the Special COA hearing is \$150. Please remit payment to the Office of Historic Preservation as soon as possible. Make the check payable to Regulatory and Economic Resources; in the memo line of the check, write HP25. Also please include a phone number on the check.

Please note that COA approval is valid for one year. If the approved scope of work has not begun within one year of the approval date, the applicant must contact the Office of Historic Preservation to request an extension. Additionally, approval of this application does not constitute approval or assurance that the proposed development satisfies applicable planning, zoning, subdivision, building, or other development regulations.

Please do not hesitate to contact our office with any questions.

Sincerely,

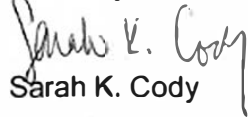

Sarah K. Cody

Historic Preservation Planner
Miami-Dade County

Cc: Mr. Joseph Benton, Fort Partners
Ms. Sarah Sinatra Gould, Town Planner, Town of Surfside
Mr. Ross Prieto, Building Official, Town of Surfside



RECEIVED
 FEB 28 2017
 MIAMI-DADE COUNTY
 OFFICE OF HISTORIC PRESERVATION

APPROVED
 MAY 17 2017
 Miami Dade County
 Office of Historic Preservation
 Authorized Signature *[Signature]*

OFFICE OF HISTORIC PRESERVATION
 111 NW 1st STREET, MAILBOX 114
 MIAMI, FL 33128
 (305) 375-4958

APPLICATION FOR A

CERTIFICATE OF APPROPRIATENESS (COA)

For Historically Designated Properties, or Properties within Historic Districts

I. PROPERTY INFORMATION INFORMACIÓN DE LA PROPIEDAD

ADDRESS (Dirección) 9149 Collins Avenue CITY (Ciudad) Surfside ZIP (Zip) 33154

SITE DESIGNATION NAME (if applicable) (Nombre del Edificio) Seaway Villas

DISTRICT NAME (if applicable) (Nombre del Distrito) _____

FOLIO NUMBER (Numero de Folio) 14-2235-015-0001

II. APPLICANT INFORMATION INFORMACIÓN DEL SOLICITANTE

NAME OF OWNER (Nombre de Dueño) Seaway Condo Acquisition LLC PHONE (teléfono) 305-571-8228

ADDRESS (Dirección) 176 NE 43rd St. Miami 33137 EMAIL (correo electrónico) _____

NAME OF APPLICANT (if other than owner) (Nombre del Solicitante) Attn: Joseph Benton

CONTACT PHONE (Teléfono) 786-214-1344 EMAIL joe@fortpartners.com

APPLICANT IS: OWNER (Dueño) RENTER/LEASEE (Inquilino) CONTRACTOR (Contratista) LEGAL AGENT (Representante legal)

FOR OFFICE USE ONLY
 Solamente por uso de oficina

APPLICATION# 2017-09-S DATE RECEIVED 2/20/17 STAFF INITIALS SJC
 ("R" for Regular, "S" for Special)

APPROVED APPROVAL DATE 5/17/17
 DENIED
 APPROVED WITH CONDITIONS BOARD DATE 3/15/17 - 5/17/17
 (see attached conditions sheet)



III. PROJECT TYPE TIPO DE PROYECTO

PLEASE CHECK ALL THAT APPLY:
 (Par favor marque todos que aplican)

- | | |
|---|--|
| <input checked="" type="checkbox"/> New Construction (<i>construcción nueva</i>) | <input checked="" type="checkbox"/> Paint (<i>pintura</i>) |
| <input checked="" type="checkbox"/> Restoration/Rehabilitation (<i>restauración</i>) | <input checked="" type="checkbox"/> Repairing Existing (<i>reparación</i>) |
| <input checked="" type="checkbox"/> Relocation/Moving a Structure (<i>traslado</i>) | <input checked="" type="checkbox"/> Landscaping (<i>areas verdes</i>) |
| <input checked="" type="checkbox"/> Demolition (<i>demolición</i>) | <input type="checkbox"/> Interior Work Only
(<i>Únicamente el Interior</i>) |
| <input checked="" type="checkbox"/> Excavation/
Ground Disturbing Activities (<i>excavación</i>) | |

IV. PROJECT DESCRIPTION DESCRIPCIÓN DE PROYECTO

Please describe in detail the proposed project, including any new construction, demolition, the removal or replacement of existing materials, and all other proposed changes to the current structure. Attach an additional sheet if necessary.

Por favor describa el proyecto en detalle. Adjuntar pagina adicional si es necesario. Por favor describir el proyecto en inglés.

Selective demolition of south building wing to accomodate connection to new hotel/residential 12-story building. Movement of 3-story building section on Collins Avenue to the east by 13-feet to achieve set-back closer to compliance with Town zoning code. Remove non-original additions at third floor terraces. Construct wood terrace at east end of building. Remodel courtyard hardscape/landscape. Modify select window/door openings at west side of north wing to provide access to a café which will provide public food/beverage service and will activate the courtyard.

CHECK ANY STRUCTURAL SYSTEMS OR ELEMENTS THAT WILL BE AFFECTED BY THIS PROJECT:

Marque el sistema estructural o componente que sera afectado por este proyecto:

- | | | |
|--|---|---|
| <input checked="" type="checkbox"/> Roof
(<i>techo</i>) | <input checked="" type="checkbox"/> Foundation
(<i>cimiento</i>) | <input checked="" type="checkbox"/> Steps or Stairways
(<i>escaleras</i>) |
| <input checked="" type="checkbox"/> Windows
(<i>ventanas</i>) | <input type="checkbox"/> Porches or Porte Cochère
(<i>portal ó porche</i>) | <input checked="" type="checkbox"/> Painting/Finishes
(<i>pintura/acabado</i>) |
| <input checked="" type="checkbox"/> Doors
(<i>puertos</i>) | <input checked="" type="checkbox"/> Siding/Stucco/Façade Work
(<i>entablado de exteriores</i>) | <input checked="" type="checkbox"/> Walls/Structural
(<i>pared ó estructura</i>) |

V. CHECKLIST OF REQUIRED ATTACHMENTS

ALL APPLICATIONS MUST INCLUDE AT LEAST ONE COLOR PHOTO OF THE BUILDING

PAINTING YOUR BUILDING

- Color photos of each side of the building to be painted
- Paint Samples of the colors you wish to use (please indicate trim, wall, and accent colors)

FENCING, WALLS, NEW POOL, DRIVEWAYS, or LANDSCAPING

- Site plan showing exact location(s) of fence, wall, pool, driveway, or proposed landscaping
- Elevation drawings of fence, including height dimensions and material
- Color photographs of the proposed location for the fence, pool, driveway, or landscaping
- Description of landscaping, including type and placement (if applicable)

WINDOWS or DOORS

- A color photograph of each side of the house
- Existing elevations, which show the window placement, configuration, and material.
- Proposed elevations, which show the new window placement, style of window, and material, and include all proposed muntins, if any
- Manufacturer's brochure or a catalog picture of the requested window or door, and NOA

NEW ROOF

- Color photos of the front of the building and existing roof
- Manufacturer's brochure of requested roof showing color and material and NOA

RENOVATIONS/ADDITIONS or NEW CONSTRUCTION

- Color photos of each side of the building
- Site plan
- Landscape plan, including documentation of any proposed tree removal (if applicable)
- Elevations of all affected facades showing Existing Conditions (11"x17" set of plans)
- Elevations of all affected facades with Proposed Alterations or Additions (11"x17" set)
- Floor Plans
- Manufacturer's brochure or catalog pictures of any new or replacement materials being used in project

VI. OWNER ATTESTATION

I certify to the best of my knowledge that all the information provided within this application is correct and accurately portrays the proposed project.

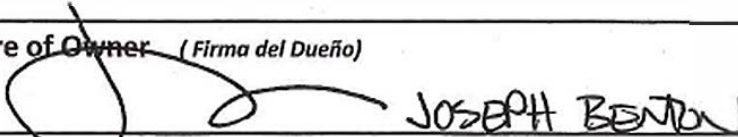
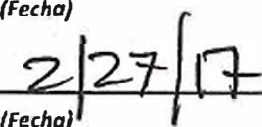
Signature of Owner (Firma del Dueño)	Date (Fecha)
	
Signature of Applicant (if other than owner) (Firma del Solicitante)	Date (Fecha)



January 22, 2018

Mr. David J. Coviello
Shutts & Bowen LLP
200 South Biscayne Boulevard
Suite 4100
Miami, FL 33131

RE: Seaway Villas, 9149 Collins Avenue, Surfside, Special COA #2017-09-S

Dear Mr. Coviello:

The Miami-Dade County Office of Historic Preservation is in receipt of your request to extend the expiration of Special COA #2017-09-S under section 252.363(1)(a)1, Florida Statutes. In accordance with the statute, and the state of emergency declared related to the Zika Virus, the new expiration date of Special COA #2017-10-S is April 25, 2020.

The following conditions remain a requirement of the approval, regardless of the new expiration date:

1. The owner shall submit a revised planting plan to staff that does not obscure the Collins Avenue façade. Staff shall provide an administrative review of the revised plan prior to construction.
2. The owner shall reconstruct the missing arched chimney cap.
3. New paving in the courtyard shall be an oolitic limestone that matches the character and color of the existing limestone.
4. The owner shall provide information on the paving material proposed for the vehicular drop-off area between Collins Avenue and the structure. Staff shall provide an administrative review of the proposed material prior to installation.
5. The open-air entry/lobby area of the building shall retain its existing terracotta-colored tile.
6. The proposed awnings for the third-story open-air terraces shall be a dark, solid color with white scallop detail edging, as documented in historic period photos. Staff shall provide an administrative review of the proposed awnings prior to installation.
7. The owner shall submit requests for COA amendments if any changes or alterations from what has been presented in this application are proposed at any time through project completion. Staff shall provide administrative reviews of any such amendment requests prior to the construction of any such proposed revision.

8. If the intent to relocate the three-story, Collins Avenue-fronting portion of the building eastward by 13 feet is altered from what was presented in this application, due to any reason, the applicant shall reappear before this Board with a request to amend the COA approval.
9. The project shall include a public space to interpret, or "tell the story," of the history of Seaway Villas, particularly its context in the early history of Surfside.

Please do not hesitate to contact our office with any questions.

Sincerely,

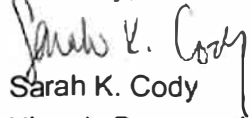

Sarah K. Cody
Historic Preservation Planner
Miami-Dade County

Cc: Mr. Joseph Benton, Fort Partners
Ms. Sarah Sinatra Gould, Town Planner, Town of Surfside
Mr. Ross Prieto, Building Official, Town of Surfside

CONDITIONAL USE REPORT

CONDITIONAL USE

Section 90-23 of the zoning code provides standards of review for Conditional Uses. Conditional Uses are generally compatible with the other land uses permitted in a zoning district but, because of their unique characteristics or potential impacts on the surrounding neighborhood and the Town as a whole, require individual review as to their location, design, configuration, and/or operation for the particular use at the particular location proposed, as well as the imposition of individualized conditions in order to ensure that the use is compatible with the surrounding neighborhoods and appropriate at a particular location.

In addition to the standards set forth in this zoning code for the particular use, all proposed Conditional Uses shall meet each of the following standards. The responses to the criteria are in italics below:

- (1) The proposed use shall be consistent with the Comprehensive Plan and the Zoning Code;

The proposed uses, which include a hotel swimming pools and outdoor dining are consistent with the Comprehensive Plan and the Zoning Code. These uses are customary for a hotel use, which is permitted in the H120 zoning districts. The proposed hotel swimming pools consist of four rooftop pools and five ground level pools at the rear of the property. Setbacks as per code are proposed to limit the visual impact of the pool decks. The setbacks will be around the entire perimeter of the deck. The outdoor dining is proposed within the courtyard of the historic building. This concept is supported by the Historic Preservation staff as a means to activate the historic building.

- (2) The establishment, maintenance or operation of the proposed use shall not be detrimental to or endanger the public health, safety, or general welfare;

The restaurant will be located within the courtyard of the historic building and is not detrimental to the public. The pools allow for safe, pedestrian circulation and will not impact the public.

- (3) The proposed use shall be compatible with the community character of the immediate neighborhood. In addition to compatibility there must be congruity between the subject development and neighboring improvements and surroundings including but not limited to form, spacing, heights, setbacks, materials, color, rhythm and pattern of architectural or aesthetic interest or value as well as with any overlays and other development schemes or legislation.

The Miami-Dade Historic Preservation Board was presented the proposed site plan at their May 17, 2017 meeting. Please see Historic Preservation Board report attached. The proposed renovations and restaurant at the Seaway portion of the site are supported by the Board. The swimming pools are consistent with the character of the zoning district and neighboring properties.

- (4) Adequate provisions shall be included for safe traffic movement, both vehicular and pedestrian, both internal to the use and in the area which will serve the use;

The proposed renovations to the Seaway building include setting the building back from the original position to allow for a driveway. This results in a safer situation than the existing condition.

- (5) Adequate measures exist including landscaping or other buffering measures or shall be taken to mitigate any adverse effects of noise, light or other potential nuisances; and

The restaurant is located in a courtyard, buffered by the north and south portions of the Seaway building. The swimming pools are at the rear and on the south side, adjacent to the Surf Club property; however they have substantial setbacks as well as landscaping to mitigate any noise.

- (6) The establishment of the Conditional Use shall not impede the development of surrounding properties for uses permitted in the zoning district; and

The buildings are surrounded by existing uses; therefore the establishment of the Conditional Uses will not impede the development of permitted uses in surrounding properties. However, the proposed development adds value to the district and is not expected to restrict future development.

- (7) Any other condition imposed by the Design Review Board and/or the Development Impact Committee.

APPLICATION & LETTER OF INTENT



ALEXANDER I. TACHMES, ESQ.
Shutts & Bowen LLP
200 South Biscayne Boulevard
Suite 4100
Miami, Florida 33131
DIRECT (305) 347-7341
FAX (305) 347-7754
EMAIL ATachmes@shutts.com

November 1, 2017

Town of Surfside
c/o Guillermo Olmedillo, Town Manager
9293 Harding Avenue
Surfside, FL 33154

Re: The Seaway Hotel and Residences – Conditional Use Application

Dear Guillermo:

Our clients, The Surf Club Apartments, Inc. and The Seaway Villas Condominium Association, Inc. (collectively, the "Applicant"), have filed a site plan application with the Town of Surfside (the "Town") for restoration and renovation of the historically significant portions of the existing Seaway structure, and for the construction of new improvements on the property located at 9133 and 9149 Collins Avenue (collectively, the "Property"). The project will consist of 48 residential units, 31 hotel units, and ancillary uses, within an 12-story structure (collectively, the "Project"). The Project is more particularly shown on the architectural plans prepared by Kobi Karp and submitted with the site plan application (collectively, the "Site Plan").

The Town Code provides that certain uses are considered "conditional uses" and require conditional use approval in accordance with the Code's criteria. Hotel swimming pools, lounges and outdoor dining areas are all considered conditional uses. Accordingly, we hereby apply for conditional use approval for the following:

Hotel Swimming Pools: As shown on Sheet A3.01 of the Site Plan, the Project contains five (5) ground level swimming pools on the Property. There are also four (4) swimming pools on the rooftop as shown on Sheet A3.08 of the Site Plan. All of the aforementioned swimming pools are private pools utilized by residents only. However, because certain residential units may be rented in the future as part of a hotel program, we are requesting conditional use approval for all swimming pools on the Property in an abundance of caution to ensure technical compliance with the requirement in the future.

Hotel Lounge: The Project contains a hotel lounge located on the ground level within the northwest portion of the historic structure as shown on Sheet A3.01 of the Site Plan.

Outdoor Dining: The Project incorporates outdoor dining in the historic courtyard on the ground level and adjacent to the restaurant on the 3rd level terrace as shown on Sheet A.3.01 of the Site Plan.

As outlined below, the conditional uses proposed by the Applicant satisfy all of the review criteria in Section 90-23.2 of the Town's Zoning Code ("Code").

- (1) *The proposed use shall be consistent with the Comprehensive Plan and the Zoning Code:*

The requested conditional uses are all customary elements of a hotel and consistent with the Town's Comprehensive Plan and the Code, including the High Density Residential/Tourist Future Land Use designation under the Comprehensive Plan and the H-120 Zoning District under the Code.

- (2) *The establishment, maintenance or operation of the proposed use shall not be detrimental to or endanger the public health, safety, or general welfare:*

As a result of careful planning and attention to detail in the design, the proposed conditional uses will not be detrimental to or endanger the public health, safety, or general welfare. As more fully addressed in the other criteria below, the form, spacing, height, setbacks and architecture were all considered in order to respect the neighborhood. Safe circulation of vehicles and pedestrians, including loading, was also carefully studied in the design. Finally, the placement of uses within the interior of the Project or adjacent to other similar uses will minimize any adverse effects on the neighborhood.

- (3) *The proposed use shall be compatible with the community character of the immediate neighborhood. In addition to compatibility there must be congruity between the subject development and neighboring improvements and surroundings including but not limited to form, spacing, heights, setbacks, materials, color, rhythm and pattern of architectural or aesthetic interest or value as well as with any overlays and other development schemes or legislation.*

The proposed conditional uses are compatible with the character of the immediate neighborhood. Consistent with the Surf Club project immediately to the south, the Project was designed to respect the neighboring improvements in terms of

form, spacing, height, setbacks and architectural design. While the size of the Property permits the Applicant to develop approximately 235 units, the Applicant is sensitive to the character of the community and is proposing only 79 units. The Project also will not require any setback variances and is completely contained within the allowable building envelope under the Code.

- (4) *Adequate provisions shall be included for parking and safe traffic movement, both vehicular and pedestrian, both internal to the use and in the area which will serve the use;*

Parking for the Project will be provided in an underground parking garage, and all parking will be valet only. To avoid congestion and prevent queuing, two drop-off areas are proposed; a south drop-off area will serve residents only, and a north drop-off will serve hotel guests and patrons, including patrons of the restaurant and lounge. A queuing analysis prepared by David Plummer & Associates was submitted with the Site Plan, which concluded no adverse issues with traffic movement. To avoid conflict with larger vehicles, the loading area is also safely located on the south side of the Property away from pedestrian circulation points.

- (5) *Adequate measures exist including landscaping or other buffering measures or shall be taken to mitigate any adverse effects of noise, light or other potential nuisances; and*

The Project has been designed to mitigate any adverse effects of noise, light or other potential nuisances. The active hotel uses are located interior to the Property or adjacent to other compatible uses. Specifically, the hotel lounge opens to the interior courtyard, and the primary swimming pool is located on the south side of the Property adjacent to another hotel, the Four Seasons Surf Club. Additionally, the Project includes lush landscaping that will create a natural sound and visibility buffer. As such, there will be minimal to no spillage of noise or light to the neighboring properties.

- (6) *The establishment of the conditional use shall not impede the development of surrounding properties for uses permitted in the zoning district; and*

As stated above, the conditional uses are consistent with the Town's Comprehensive Plan and the Code. The Project has also been designed to be compatible with the character of the immediate neighborhood and mitigate any adverse effects on the neighboring properties. As such, the Project will not

Town of Surfside
c/o Guillermo Olmedillo, Town Manager
November 1, 2017
Page 4

impede the development of surrounding properties for uses permitted in the zoning district.

(7) *Any other condition imposed by the design review board and/or the development impact committee.*

Not applicable.

We look forward to answering any questions you might have and to presenting our outstanding project to the Town in more detail. Thank you.

Sincerely,

SHUTTS & BOWEN LLP



Alexander I. Tachmes, Esq.

cc: Ms. Sarah Sinatra Gould, AICP

MIADOC5154322311



**TOWN OF SURFSIDE
CONDITIONAL USE APPLICATION**

Approval of such conditional use(s) shall only be granted where it has been clearly shown that the public health, safety, morals, and general welfare will not be adversely affected; that adequate off-street parking facilities, in accordance with this chapter, will be provided; and that necessary safeguards will be provided for the protection of surrounding property.

A complete submittal includes all items on the "Submission Checklist for Conditional Use Application" document as well as completing this application in full. The owner and agent must sign the application with the appropriate supplemental documentation attached. Please print legibly in ink or type on this application form.

PROJECT INFORMATION	
OWNER'S NAME	The Surf Club Apartments, Inc. and The Seaway Villas Condominium Association, Inc.*
PHONE / FAX	305-347-7341
AGENT'S NAME	c/o Alexander I. Tachmes, Esq.
ADDRESS	Shutts & Bowen, LLP, 200 S. Biscayne Boulevard, Suite 4100, Miami, FL 33131
PHONE / FAX	305-347-7341
PROPERTY ADDRESS	9133 Collins Avenue and 9149 Collins Avenue, Surfside, FL 33154
ZONING CATEGORY	H-120
DESCRIPTION OF CONDITIONAL USE REQUESTED (please use separate sheet if necessary)	Hotel Swimming Pools and a Hotel Bar/Lounge, and Outdoor Dining Facilities; all pursuant to Section 90-41 of the Surfside Code of Ordinances.

*The Seaway Villas Condominium Association, Inc. is the condominium association established to govern the existing condominium property known as The Seaway Condominium.

INTERNAL USE ONLY	
Date Submitted _____	Project Number _____
Report Completed _____	Date _____
Comments _____	

 SIGNATURE OF OWNER 10/10/17
 DATE

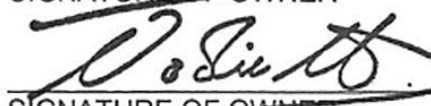
 SIGNATURE OF OWNER 10/10/17
 DATE

 SIGNATURE OF AGENT 11/1/17
 DATE



TOWN OF SURFSIDE
CONDITIONAL USE APPLICATION
PLANNING AND ZONING BOARD RULES AND PROCEDURES (JUNE 2002)

The Planning and Zoning Board shall generally meet the last Thursday of each month at 7:00 pm. at Town Hall.

Plans and completed applications (including all supporting documentation) must be submitted to the Building Department at least 21 days prior to the meeting, with the payment of applicable fees (example: \$200.00 for Plan Review for Zoning), at which time they will be considered. Incomplete plans and applications will not be processed.

The applicant or duly authorized agent (per ownership affidavit) must be present at the meeting. If there are no applications for consideration by the Planning and Zoning Board, the monthly meeting may be cancelled at the discretion of the Chairman of the Board.

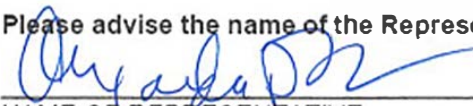
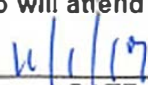
Please advise the name of the Representative who will attend the hearing on behalf of this application:	
	
NAME OF REPRESENTATIVE	DATE

RESOLUTION NO. 18- _____

A RESOLUTION OF THE TOWN COMMISSION OF SURFSIDE, FLORIDA; APPROVING A SITE PLAN APPLICATION FOR PROPERTY GENERALLY LOCATED AT 9133-9149 COLLINS AVENUE, SURFSIDE, FL, FOR DEVELOPMENT CONSISTING OF 48 CONDOMINIUM UNITS, 31 HOTEL ROOMS, AND AN 1,100 SQUARE FOOT RESTAURANT AND LOUNGE; AND PROVIDING CONDITIONAL USE APPROVAL FOR THE HOTEL SWIMMING POOLS AND OUTDOOR DINING INCLUDED IN THE SITE PLAN; AND PROVIDING FOR A SEVERABILITY CLAUSE AND AN EFFECTIVE DATE.

WHEREAS, The Surf Club Apartments, Inc. and The Seaway Villas Condominium Association, Inc. (together, the “Applicant”), owner of the property generally located at 9133-9149 Collins Avenue, Surfside, FL 33154 and legally described as provided on Exhibit “A” attached hereto (the “Property”), submitted an application to the Town of Surfside, Florida (the “Application”), requesting site plan approval for the development of 48 condominium units, 31 hotel rooms, and an 1,100 square foot restaurant and lounge; and requesting conditional use approval for the hotel swimming pools and outdoor dining incorporated in the site plan.

WHEREAS, the Miami-Dade Historic Preservation Board reviewed the site plan application on September 21, 2016 and, with final revisions, on May 17, 2017 and recommended approval of the application with conditions which the Town desires to include as conditions of this approval; and

WHEREAS, on September 4, 2015, April 18, 2016, and September 28, 2017 the Town’s Development Review Group, pursuant to Section 90.20 of the Town Code, met to review the site plan application and provide technical comments to the Town staff and to the Applicant; and

WHEREAS, the Town’s Development Impact Committee, after advertised notice and notice posted on the Town’s website, met on July 27, 2016 and September 28, 2017, and during the televised meetings, reviewed the Application and made recommendations to the Planning and Zoning Board in accordance with the criteria set forth in the Town Code; and

WHEREAS, on January 25, 2018, the Planning & Zoning Board, at a duly noticed and televised quasi-judicial public hearing, after reviewing the Application and hearing from its professional staff, the Applicant, and members of the public, considered the requirements of the Town Code for Site Plan and Conditional Use Approval and the Application’s consistency with the Town of Surfside’s Comprehensive Plan and recommended the Application for Approval by

the Town Commission, subject to the conditions of approval incorporated herein under Section IV. Conditions and with the request to revisit the driveway at the Seaway and consider removing it and that the applicant add additional valets if queuing issues arise on Collins Avenue; and

WHEREAS, on February 13, 2018, the Town Commission, at a duly noticed and televised quasi-judicial public hearing, reviewed the Application and hearing from its professional staff, the Applicant, and members of the public, and considering the recommendation of the Planning & Zoning Board, the requirements of the Town Code for Site Plan and Conditional Use Approval and the Application's consistency with the Town of Surfside's Comprehensive Plan, and the substantial competent evidence presented at the hearing.

NOW THEREFORE, BE IT RESOLVED BY THE TOWN COMMISSION OF THE TOWN OF SURFSIDE, FLORIDA, APPLICABLE TO APPLICANT, ITS SUCCESSORS AND/OR ASSIGNS, AS FOLLOWS:

SECTION 1. RECITALS AND FINDINGS OF FACT.

1. All recitals set forth above are incorporated into the body of this Resolution as if same were fully set forth herein.
2. The Commission finds that the proposed site plan and conditional uses are in compliance with the requirements of the Town Code for Site Plan and Conditional Use Approval and the Application is consistent with the Town of Surfside's Comprehensive Plan.

SECTION 2. SITE PLAN APPROVAL. The request to approve a site plan is hereby granted as shown on the site plan submitted to the Building Department on February 6, 2018 by Kobi Karp Architecture and Interior Design, Inc. dated October 2017 and provided for the public hearing, except as modifications are required by this approval or the Building Official.

SECTION 3. CONDITIONAL USE APPROVAL. The conditional use of the property for 4 rooftop hotel pools and 5 ground level hotel pools and for outdoor dining, as shown on the site plan approved herein, is hereby granted.

SECTION 4. CONDITIONS. The APPROVALS granted herein are subject to the following conditions:

1. The construction and uses shall be in accordance with the submitted plans for the hearing entitled "The Seaway Hotel and Residences" and dated October 2017, as submitted to the Building Department on February 6, 2018 and incorporated into this document as Exhibit "B" except as modifications may be required by this approval and any changes required by the Building Official.

2. Pursuant to Section 90-20.3, the applicant shall secure a building permit for the project no later than January 25, 2020.
3. The applicant shall comply with the conditions imposed by the Miami-Dade Historic Preservation Board on May 17, 2017, as provided with the staff report, which conditions are incorporated herein as part of this approval.
4. The underground utilities on the approved site plan shall be installed without alternatives. The Applicant shall demonstrate the underground utilities will be accommodated in the configuration proposed prior to a foundation permit.
5. The Applicant shall install a plaque on the exterior of the historic building notifying the public of the historic designated building, subject to approval by the Miami Dade County Historic Preservation Board.
6. All voluntary proffers and commitments made to the Town of Surfside pursuant to the Resolution, including but not limited to those described in these Conditions, shall be binding upon Applicant, its heirs, successors and assigns, and, as to payments, shall be due and payable, or in the event of an action, shall be performed, in strict compliance with the manner and within the time frames set forth in these Conditions and any change in ownership, or modification of the site plan or design, whether substantial or minor in nature, shall not excuse the performance or the payments, all of which are part of the Conditions subject to which the Applicant's request for site plan approval were granted.
7. The Applicant has voluntarily proffered \$250,000 to the Town to address the impacts of the development, which shall be paid 90 days after approval of this development order. Upon obtaining the first building permit inspection, this payment shall be non-refundable.
8. The Applicant shall provide a bond not to exceed five percent of the construction cost, as required by the Building Official. These funds shall be used to secure property and the construction site in the event construction is abandoned, or ceases prior to completion, or to repair public infrastructure damaged by construction and to maintain the site during abandonment.
9. The Applicant shall maintain an interactive website during construction and provide for a maximum of 24 hour response complaint/response mechanism for nearby property owners. The website URL will be advertised to Town residents.

10. The applicant agrees to design the project to be LEED silver certifiable.
11. Sixty days prior to submittal of its request for a demolition permit, Applicant shall submit a demolition plan to Town Manager and Town Building Official that meets all Federal, State, and local requirements and that recycles a minimum of eighty percent (80%) of the demolition material.
12. The Applicant shall provide a construction fence with a windscreen, as required by the Town Code. The windscreen shall display a rendering of the project and be maintained in good condition throughout the construction process.
13. The Applicant shall meet all requirements of the Department of Public Works for the location and design of trash containers prior to the issuance of a building permit. All service roll gates shall be at least 15 feet high and shall be of a decorative design to enhance the aesthetics of the building.
14. The Applicant shall present evidence of a Construction Parking Plan for the provision of off-street parking outside of Town limits or on Applicant's property within the Town, for construction workers during the period of construction of the approved project prior to the issuance of a building permit. The Applicant and the Applicant's general contractor shall direct all workers not to park their vehicles in residential neighborhoods or lease parking spaces from Town residents or park in Town parking lots and Town parking metered spaces. The Construction Parking Plan shall be reviewed and approved by the Town Manager prior to the issuance of a building permit.
15. The Applicant and the Applicant's general contractor are responsible to enforce the Construction Parking Plan with all employees, contractors and subcontractors. The Applicant shall be fined five hundred dollars (\$500) for each parking ticket issued to construction workers for parking in residential neighborhoods or Town public parking while working on the construction site (limit of one fine per vehicle per day). The construction parking plan shall provide the following:
 - (a) No workers shall park their vehicles in residential neighborhoods or Town public parking spaces; and
 - (b) Applicant shall provide monthly reports to the Town Manager of any problems or complaints with regard to workers parking their vehicles in residential neighborhoods; and

- (c) If the Town Manager deems necessary, the Applicant shall provide more frequent reports and develop additional preventive measures to protect the residential neighborhoods.
16. The Applicant agrees that all contractor and subcontractor agreements applicable to this development shall include a separate clause prohibiting construction workers from parking on residential streets or public parking lots and that Applicant shall submit the proposed clause for the approval of the Town Manager or Town Manager Designee within 45 days of the effective date of this Resolution.
17. Any change in ownership of the current property owner, up to and including the turnover of ownership to the condominium association, greater than twenty percent (20%) shall be fully disclosed in writing to the Town Manager and Town Attorney immediately upon said change occurring. Any change of ownership of the project shall not extend or modify any of the dates for payment or performance included in this Resolution or in any related agreements referenced in this Resolution nor shall any change of ownership modify or excuse or extend any of the payment obligations contained in this Resolution or in any related agreements referenced in this Resolution. All payment obligations and performance obligations of any kind set forth in this Resolution and in these Conditions are binding on the Applicant, its heirs, successors and assigns.
18. Pursuant to Section 90-60.1(5) of the Town Code, the Applicant shall provide a perpetual, irrevocable, hardpack access easement agreement, in a form acceptable to the town manager and approved as to legal sufficiency by the town attorney, with consideration given to the Planning and Zoning Board recommendation that the location of the easement provide public access up to the Erosion Control Line which includes the beach walking path and the dune. The Easement shall be executed, recorded and submitted to the Town by the Applicant within 60 days of this approval.
19. The applicant shall provide a Unity of Title in a form acceptable to the Town Attorney for all parcels included in the site plan to the Town prior to the issuance of the first building permit.
20. The Applicant shall ensure the Town's water/sewer infrastructure is ready to receive the approved utility connections referenced in Condition 1 above. At the option of the Town, the Town may allow the Applicant to construct improvements to the Town water/sewer infrastructure and provide a credit to the Applicant on the basis of one-half the reasonable cost of improvements.

21. The Applicant shall provide the Town with a detailed schedule for the construction of the project (the "Construction Schedule") within sixty (60) days of approval of the Application by the Town Commission.

22. The approved site plan does not in any way create a right on the part of the applicant to obtain a permit from a state or federal agency, and does not create liability on the part of the Town for issuance of the approval if the applicant fails to obtain requisite approvals or fulfill the obligations imposed by a state or federal agency or undertakes action that result in a violation of federal or state law.

23. All applicable state and federal permits shall be obtained before commencement of construction.

SECTION 5. VIOLATION OF CONDITIONS. Failure to adhere to the terms and conditions of this Resolution shall be considered a violation of the Town Code and persons found violating the conditions shall be subject to the penalties prescribed by the Town Code, including but not limited to, the revocation of any of the approval(s) granted in this Resolution. The Applicant understands and acknowledges that it must comply with all other applicable requirements of the Town Code before it may commence construction or operation, and that the foregoing approval in this Resolution may be revoked by the Town at any time upon a determination that the Applicant is in non-compliance with the Town Code or the conditions of this Approval.

SECTION 6. SEVERABILITY CLAUSE. In the event any portion or section of this Resolution is determined to be invalid, illegal or unconstitutional by a court or agency of competent jurisdiction, such decision shall in no way affect the remaining portions of this Resolution, which shall remain full force and effect.

SECTION 7. EFFECTIVE DATE. This Resolution shall become effective upon adoption.

PASSED AND ADOPTED this 13th day of February, 2018.

Motion by: _____,

Second by: _____.

FINAL VOTE ON ADOPTION

Commissioner Daniel Gielchinsky _____
Commissioner Michael Karukin _____
Commissioner Tina Paul _____
Vice Mayor Barry Cohen _____
Mayor Daniel Dietch _____

Daniel Dietch, Mayor

ATTEST:

Sandra Novoa, MMC, Town Clerk

**APPROVED AS TO FORM AND LEGAL SUFFICIENCY
FOR THE TOWN OF SURFSIDE ONLY:**

Weiss Serota Helfman Cole & Bierman, P.L.
Town Attorney

STATE OF FLORIDA)
COUNTY OF MIAMI-DADE)

I, Sandra Novoa, Town Clerk of the Town of Surfside, Florida, do hereby certify that the above and foregoing is a true and correct copy of Resolution No. 18-____ adopted by the Town Commission at its meeting held on the ____ day of _____, 2018.

Issued: _____

Sandra Novoa, MMC
Town Clerk

RESOLUTION 18-2489

RESOLUTION NO. 18-2489

A RESOLUTION OF THE TOWN COMMISSION OF SURFSIDE, FLORIDA; APPROVING A SITE PLAN APPLICATION FOR PROPERTY GENERALLY LOCATED AT 9133-9149 COLLINS AVENUE, SURFSIDE, FL, FOR DEVELOPMENT CONSISTING OF 48 CONDOMINIUM UNITS, 31 HOTEL ROOMS, AND AN 1,100 SQUARE FOOT RESTAURANT AND LOUNGE; AND PROVIDING CONDITIONAL USE APPROVAL FOR THE HOTEL SWIMMING POOLS AND OUTDOOR DINING INCLUDED IN THE SITE PLAN; AND PROVIDING FOR A SEVERABILITY CLAUSE AND AN EFFECTIVE DATE.

WHEREAS, The Surf Club Apartments, Inc. and The Seaway Villas Condominium Association, Inc. (together, the "Applicant"), owner of the property generally located at 9133-9149 Collins Avenue, Surfside, FL 33154 and legally described as provided on Exhibit "A" attached hereto (the "Property"), submitted an application to the Town of Surfside, Florida (the "Application"), requesting site plan approval for the development of 48 condominium units, 31 hotel rooms, and an 1,100 square foot restaurant and lounge; and requesting conditional use approval for the hotel swimming pools, hotel lounge, and outdoor dining incorporated in the site plan.

WHEREAS, the Miami-Dade Historic Preservation Board reviewed the site plan application on September 21, 2016 and, with final revisions, on May 17, 2017 and recommended approval of the application with conditions which the Town desires to include as conditions of this approval; and

WHEREAS, on September 4, 2015, April 18, 2016, and September 28, 2017 the Town's Development Review Group, pursuant to Section 90.20 of the Town Code, met to review the site plan application and provide technical comments to the Town staff and to the Applicant; and

WHEREAS, the Town's Development Impact Committee, after advertised notice and notice posted on the Town's website, met on July 27, 2016 and September 28, 2017, and during the televised meetings, reviewed the Application and made recommendations to the Planning and Zoning Board in accordance with the criteria set forth in the Town Code; and

WHEREAS, on January 25, 2018, the Planning & Zoning Board, at a duly noticed and televised quasi-judicial public hearing, after reviewing the Application and hearing from its professional staff, the Applicant, and members of the public, considered the requirements of the Town Code for Site Plan and Conditional Use Approval and the Application's consistency with

the Town of Surfside's Comprehensive Plan and recommended the Application for Approval by the Town Commission, subject to the conditions of approval incorporated herein under Section IV. Conditions and with the request to revisit the driveway at the Seaway and consider removing it and that the Applicant add additional valets if queuing issues arise on Collins Avenue; and

WHEREAS, on February 13, 2018, the Town Commission, at a duly noticed and televised quasi-judicial public hearing, reviewed the Application and hearing from its professional staff, the Applicant, and members of the public, and considering the recommendation of the Planning & Zoning Board, the requirements of the Town Code for Site Plan and Conditional Use Approval and the Application's consistency with the Town of Surfside's Comprehensive Plan, and the substantial competent evidence presented at the hearing.

NOW THEREFORE, BE IT RESOLVED BY THE TOWN COMMISSION OF THE TOWN OF SURFSIDE, FLORIDA, APPLICABLE TO APPLICANT, ITS SUCCESSORS AND/OR ASSIGNS, AS FOLLOWS:

SECTION 1. RECITALS AND FINDINGS OF FACT.

1. All recitals set forth above are incorporated into the body of this Resolution as if same were fully set forth herein.
2. The Commission finds that the proposed site plan and conditional uses are in compliance with the requirements of the Town Code for Site Plan and Conditional Use Approval and the Application is consistent with the Town of Surfside's Comprehensive Plan.

SECTION 2. SITE PLAN APPROVAL. The request to approve a site plan is hereby granted as shown on the site plan submitted to the Building Department on February 6, 2018 by Kobi Karp Architecture and Interior Design, Inc. dated October 2017 and provided for the public hearing, except as modifications are required by this approval or the Building Official.

SECTION 3. CONDITIONAL USE APPROVAL. The conditional use of the property for 4 rooftop hotel pools and 5 ground level hotel pools, hotel lounge, and for outdoor dining, as shown on the site plan approved herein, is hereby granted.

SECTION 4. CONDITIONS. The APPROVALS granted herein are subject to the following conditions:

1. The construction and uses shall be in accordance with the submitted plans for the hearing entitled "The Seaway Hotel and Residences" and dated October 2017, as submitted to the Building Department on February 6, 2018 and incorporated into this document as Exhibit "B" except as modifications may be required by this approval

and any changes required by the Building Official.

2. Pursuant to Section 90-20.3, the Applicant shall secure a building permit for the project no later than January 25, 2020.
3. The Applicant shall comply with the conditions imposed by the Miami-Dade Historic Preservation Board on May 17, 2017, as provided with the staff report, which conditions are incorporated herein as part of this approval.
4. The underground utilities on the approved site plan shall be installed in accordance with said site plan, unless administratively modified by Town staff. The Applicant shall demonstrate the underground utilities will be accommodated in the configuration proposed prior to a foundation permit.
5. The Applicant shall install a plaque on the exterior of the historic building notifying the public of the historic designated building, subject to approval by the Miami Dade County Historic Preservation Board.
6. All voluntary proffers and commitments made to the Town of Surfside pursuant to the Resolution, including but not limited to those described in these Conditions, shall be binding upon Applicant, its heirs, successors and assigns, and, as to payments, shall be due and payable, or in the event of an action, shall be performed, in strict compliance with the manner and within the time frames set forth in these Conditions and any change in ownership, or modification of the site plan or design, whether substantial or minor in nature, shall not excuse the performance or the payments, all of which are part of the Conditions subject to which the Applicant's request for site plan approval were granted.
7. The Applicant has voluntarily proffered \$250,000 to the Town to address the impacts of the development, which shall be paid within one year after approval of this development order or prior to issuance of the building permit, whichever is earlier. Upon obtaining the first building permit inspection, this payment shall be non-refundable.
8. The Applicant shall provide a bond not to exceed five percent of the construction cost, as required by the Town Manager. These funds shall be used to secure property and the construction site in the event construction is abandoned, or ceases prior to completion, or to repair public infrastructure damaged by construction and to maintain the site during abandonment.

9. The Applicant shall provide an email address as a point of contact for neighbors during construction and provide for a maximum of 24 hour response time. The email address will be advertised to Town residents.
10. The Applicant agrees to design the project to be LEED silver certifiable as evaluated at the time of building permit.
11. The Applicant agrees to obtain Florida Green Lodging Program designation for the project.
12. Sixty days prior to submittal of its request for a demolition permit, Applicant shall submit a demolition plan to Town Manager and Town Building Official that meets all Federal, State, and local requirements and that recycles a minimum of eighty percent (80%) of the demolition material.
13. The Applicant shall provide a construction fence with a windscreen, as required by the Town Code. The windscreen shall display a rendering, graphic or mural for aesthetic enhancement of the project, which shall be approved by the Town Manager, and be maintained in good condition throughout the construction process.
14. The Applicant shall ensure all lighting is installed and operated in a manner protective of wild life including sea turtles, pursuant to all applicable state law and the Town of Surfside Code of Ordinances, as may be amended from time to time.
15. The Applicant shall present evidence of a Construction Parking Plan for the provision of off-street parking outside of Town limits or on Applicant's property within the Town, for construction workers during the period of construction of the approved project prior to the issuance of a building permit. The Applicant and the Applicant's general contractor shall direct all workers not to park their vehicles in residential neighborhoods or lease parking spaces from Town residents or park in Town parking lots and Town parking metered spaces. The Construction Parking Plan shall be reviewed and approved by the Town Manager prior to the issuance of a building permit.
16. The Applicant and the Applicant's general contractor are responsible to enforce the Construction Parking Plan with all employees, contractors and subcontractors. The Applicant shall be fined five hundred dollars (\$500) for each parking ticket issued to construction workers for parking in residential neighborhoods or Town public parking while working on the construction site (limit of one fine per vehicle per day). The construction parking plan shall provide the following:

- (a) No workers shall park their vehicles in residential neighborhoods or Town public parking spaces; and
 - (b) Applicant shall provide monthly reports to the Town Manager of any problems or complaints with regard to workers parking their vehicles in residential neighborhoods; and
 - (c) If the Town Manager deems necessary, the Applicant shall provide more frequent reports and develop additional preventive measures to protect the residential neighborhoods.
17. The Applicant agrees that all contractor and subcontractor agreements applicable to this development shall include a separate clause prohibiting construction workers from parking on residential streets or public parking lots and that Applicant shall submit the proposed clause for the approval of the Town Manager or Town Manager Designee within 90 days of the effective date of this Resolution.
18. Any change in ownership of the current property owner, up to and including the turnover of ownership to the condominium association, greater than twenty percent (20%) shall be fully disclosed in writing to the Town Manager and Town Attorney immediately upon said change occurring. Any change of ownership of the project shall not extend or modify any of the dates for payment or performance included in this Resolution or in any related agreements referenced in this Resolution nor shall any change of ownership modify or excuse or extend any of the payment obligations contained in this Resolution or in any related agreements referenced in this Resolution. All payment obligations and performance obligations of any kind set forth in this Resolution and in these Conditions are binding on the Applicant, its heirs, successors and assigns.
19. Pursuant to Section 90-60.1(5) of the Town Code, the Applicant shall provide a perpetual, irrevocable, hardpack access easement agreement, in a form acceptable to the town manager and approved as to legal sufficiency by the town attorney, with consideration given to the Planning and Zoning Board recommendation that the location of the easement provide public access up to the Erosion Control Line which includes the beach walking path and the dune. The Easement shall be executed, recorded and submitted to the Town by the Applicant within one year of this approval or prior to issuance of the building permit, whichever is earlier.
20. The Applicant shall provide a Unity of Title in a form acceptable to the Town Attorney for all parcels included in the site plan to the Town prior to the issuance of

the first building permit.

21. The Applicant shall ensure the Town's water/sewer infrastructure is ready to receive the approved utility connections referenced in Condition 1 above. At the option of the Town Commission, the Town may allow the Applicant to construct improvements to the Town water/sewer infrastructure at the Applicant's expense and provide a credit to the Applicant on the basis of one-half the reasonable cost of improvements up to a credit of \$250,000, which shall be credited against the voluntary proffer of \$250,000 offered to address the impacts of development (see condition 7).
22. The Applicant shall provide the Town with a detailed schedule for the construction of the project (the "Construction Schedule") within 90 days of approval of the Application by the Town Commission.
23. The approved site plan does not in any way create a right on the part of the Applicant to obtain a permit from a state or federal agency, and does not create liability on the part of the Town for issuance of the approval if the Applicant fails to obtain requisite approvals or fulfill the obligations imposed by a state or federal agency or undertakes action that result in a violation of federal or state law.
24. All applicable state and federal permits shall be obtained before commencement of construction.
25. The Applicant will restore all roadways impacted by the construction of the project to like new condition within 60 calendar days of issuance of a Temporary Certificate of Occupancy (TCO) or if no TCO is obtained, issuance of a Certificate of Occupancy.
26. Applicant shall meet with Town representatives to inspect roadways surrounding the project and evaluate the need for immediate repairs. Further, the Applicant will repair the dip in the roadway on 91st Street within 60 calendar days of this approval.
27. The Applicant shall restrict pesticide use to organic-based environmentally friendly products as part of their landscaping plan and maintenance.

SECTION 5. VIOLATION OF CONDITIONS. Failure to adhere to the terms and conditions of this Resolution shall be considered a violation of the Town Code and persons found violating the conditions shall be subject to the penalties prescribed by the Town Code, including but not limited to, the revocation of any of the approval(s) granted in this Resolution.

The Applicant understands and acknowledges that it must comply with all other applicable requirements of the Town Code before it may commence construction or operation, and that the foregoing approval in this Resolution may be revoked by the Town at any time upon a determination by the Town Commission, following a public hearing, that the Applicant is in non-compliance with the Town Code or the conditions of this Approval and has failed to cure, or to provide an acceptable plan to timely cure, the non-compliance.

SECTION 6. SEVERABILITY CLAUSE. In the event any portion or section of this Resolution is determined to be invalid, illegal or unconstitutional by a court or agency of competent jurisdiction, such decision shall in no way affect the remaining portions of this Resolution, which shall remain full force and effect.

SECTION 7. EFFECTIVE DATE. This Resolution shall become effective upon adoption.

PASSED AND ADOPTED this 13th day of February, 2018.

Motion by: Commissioner Karukin.

Second by: Commissioner Gielchinsky.

FINAL VOTE ON ADOPTION

Commissioner Daniel Gielchinsky
Commissioner Michael Karukin
Commissioner Tina Paul
Vice Mayor Barry Cohen
Mayor Daniel Dietch

yes
yes
NO
yes
yes



Daniel Dietch, Mayor

ATTEST:



Sandra Novoa, MMC, Town Clerk

**APPROVED AS TO FORM AND LEGAL SUFFICIENCY
FOR THE TOWN OF SURFSIDE ONLY:**



Weiss Serota Helfman Cole & Bierman, P.L.
Town Attorney

STATE OF FLORIDA)
COUNTY OF MIAMI-DADE)

I, Sandra Novoa, Town Clerk of the Town of Surfside, Florida, do hereby certify that the above and foregoing is a true and correct copy of Resolution No. 18-2489 adopted by the Town Commission at its meeting held on the 13th day of February, 2018.

Issued: 2/13/2018



Sandra Novoa, MMC
Town Clerk

LETTER REQUESTING TO EXTEND DATE OF SITE PLAN

Via Email

February 12, 2020

Mr. Guillermo Olmedillo
Town Manager, Surfside
9293 Harding Avenue
Surfside, FL 33154

Re: *Effective Period of Site Plan Approval Confirmation or Extension: Surf Club Apartments, Inc. and the Seaway Villas Condominium Association/ Resolution No. 18-2489*

Dear Manager Olmedillo:

This correspondence is transmitted to you on behalf of this firm's clients, Surf Club Apartments, Inc. and the Seaway Villas Condominium Association, Inc. ("Owners"), the owners of property located at 9133-9149 Collins Avenue, Surfside, FL and commonly known as the Seaway Villas and Surf Club Apartments (the "Property"), for the purpose of confirming the effective period of a site plan approval and, should we disagree as to the effective period, to request an extension of the site plan approval.

The Site Plan for the Surf Club Apartments, Inc. and the Seaway Villas Condominium Association, Inc. was approved on February 13, 2018 via Resolution 18-2489 (the "Site Plan Approval"). Under section 90-20.3, Town Code, the Site Plan Approval is effective for 24 months, through February 13, 2020.

Under section 252.363(1)(a), Fla. Stat., however, "[t]he declaration of a state of emergency issued by the Governor for a natural emergency tolls the period remaining to exercise the rights under a permit or other authorization for the duration of the emergency declaration." On August 28, 2019, Governor Ron DeSantis issued Executive Order 19-189, in which he declared that a state of emergency existed due to Hurricane Dorian affecting 26 counties, including Miami-Dade County. The duration of the emergency declaration for Miami-Dade County lasted for 60 days. Prior to EO 19-189, the following State of Emergencies affecting Miami-Dade County were also issued and had a tolling effect on the effective period of the Site Plan Approval: EO 18-282 (Red Tide, 120 Days); EO 18-281 (Hurricane Maria, 108 Days); EO 18-253 (Hurricane Florence, 60 days).

Accordingly, Owners would like to confirm our firm's calculation that the Site Plan Approval is effective through January 23, 2021.¹

Should you disagree with our firm's calculation and determine that the effective period of the Site Plan Approval expires any earlier than January 23, 2021, please advise us as soon as possible and, in an abundance of caution, consider this correspondence as a request for a one-year extension (through February 13, 2021) pursuant to section 90-20.3, Town Code, related to the following "good cause" assertions: substitution of architect; market conditions; and site plan changes/parking and program changes.

Thank you in advance for your consideration and, as always, should you have any questions, please don't hesitate to contact us.

Sincerely,



John K. Shubin
Ian E. DeMello
For the firm

¹ 348 days from February 13, 2020.

**LETTER REQUESTING TO PLACE
ITEM ON NEXT AVAILABLE
COMMISSION AGENDA**

Via Email

June 10, 2020

Mr. Guillermo Olmedillo
Town Manager, Surfside
9293 Harding Avenue
Surfside, FL 33154

Re: *Agenda Item Request - Surf Club Apartments, Inc. and the Seaway Villas Condominium Association Site Plan Extension (Resolution No. 18-2489)*

Dear Town Manager Olmedillo:

This correspondence is transmitted to you on behalf of this firm's clients, Surf Club Apartments, Inc. and the Seaway Villas Condominium Association, Inc. ("Owners"), the owners of property located at 9133-9149 Collins Avenue, Surfside, FL and commonly known as the Seaway Villas and Surf Club Apartments (the "Property"), for the purpose of requesting that the Town place on the next available Commission Agenda, Owners' February 12, 2020 request for a one-year extension of Owners' Site Plan Approval (Resolution 18-2489 (the "Site Plan Approval")) pursuant to section 90-20.3, Town Code.

Thank you in advance for your consideration and, as always, should you have any questions, please don't hesitate to contact us.

Sincerely,



John K. Shubin
Ian E. DeMello
For the firm

cc: Lillian M. Arango, Esq., Town Attorney
Sandra N. McCready, MMC, Town Clerk
James Hickey, Town Planner

**OFFICE OF HISTORIC
PRESERVATION EXTENSION
APPROVAL**



April 29, 2020

Mr. Ian DeMello
Shubin & Bass, P.A.
46 SW First Street, Third Floor
Miami, FL 33130

RE: Seaway Villas, 9149 Collins Avenue, Surfside, Special COA #2019-32-S

Dear Mr. DeMello:

The Miami-Dade County Office of Historic Preservation is in receipt of your request to extend the expiration of Special COA #2019-32-S under section 252.363(1)(a)1, Florida Statutes. In accordance with the statute, and the state of emergency declared related to the coronavirus, the new expiration date of Special COA #2019-32-S is May 17, 2021.

The following conditions remain a requirement of the approval, regardless of the new expiration date:

1. The owner shall submit the LIDAR documentation to Staff upon completion.
2. The owner shall salvage any character-defining architectural features for reuse in the reconstructed building, to the greatest extent feasible.
3. The reconstructed building shall be based upon the LIDAR results in conjunction with a thorough review of the original 1936 building plans and other historic period documents to ensure that the reconstructed building accurately reflects the historic character and features, rather than features that were altered over time.
4. The owner shall submit the proposed building plans to Staff for administrative review prior to undertaken reconstruction.
5. The owner shall submit a revised planting plan to staff that does not obscure the Collins Avenue façade. Staff shall provide an administrative review of the revised plan prior to construction.
6. The owner shall reconstruct the missing arched chimney cap.
7. New paving in the courtyard shall be an oolitic limestone that matches the character and color of the existing limestone.
8. The owner shall provide information on the paving material proposed for the vehicular drop-off area between Collins Avenue and the structure. Staff shall provide an administrative review of the proposed material prior to installation.



Regulatory and Economic Resources Department

Office of Historic Preservation

111 NW 1st Street, Mailbox 114 • 12th Floor
Miami, Florida 33128
T 305-375-4958

9. The open-air entry/lobby area of the building shall retain its existing terracotta-colored tile.
10. The proposed awnings for the third-story open-air terraces shall be a dark, solid color with white scallop detail edging, as documented in historic period photos. Staff shall provide an administrative review of the proposed awnings prior to installation.
11. The owner shall submit requests for COA amendments if any changes or alterations from what has been presented in this application are proposed at any time through project completion. Staff shall provide administrative reviews of any such amendment requests prior to the construction of any such proposed revision.
12. If the intent to relocate the three-story, Collins Avenue-fronting portion of the building eastward by 13 feet is altered from what was presented in this application, due to any reason, the applicant shall reappear before this Board with a request to amend the COA approval.
13. The project shall include a public space to interpret, or "tell the story," of the history of Seaway Villas, particularly its context in the early history of Surfside.

Please do not hesitate to contact our office with any questions.

Sincerely,

A handwritten signature in black ink that reads "Sarah K. Cody".

Sarah K. Cody

Historic Preservation Chief
Miami-Dade County

Cc: Mr. Mike Conaghan, Fort Partners
Ms. Sarah Sinatra Gould, Town Planner, Town of Surfside
Mr. Ross Prieto, Building Official, Town of Surfside

RESOLUTION NO. 2020-_____

A RESOLUTION OF THE TOWN COMMISSION OF THE TOWN OF SURFSIDE, FLORIDA, [APPROVING/DENYING] A REQUEST TO EXTEND SITE PLAN AND CONDITIONAL USE APPROVAL GRANTED BY RESOLUTION NO. 18-2489 FOR THE PROPERTY LOCATED AT 9133-9149 COLLINS AVENUE, SURFSIDE, FLORIDA (THE “PROPERTY”); CLARIFYING EFFECTIVENESS OF ORIGINAL TERMS AND CONDITIONS; AND PROVIDING FOR AN EFFECTIVE DATE.

WHEREAS, pursuant to Resolution No. 18-2489 (the “Resolution”) adopted on February 13, 2018, Surf Club Apartments, Inc. and the Seaway Villas Condominium, Inc. (collectively, the “Owners”) received site plan and conditional use approval for a development consisting of 48 condominium units, 31 hotel rooms, and an 1,100 square foot restaurant and lounge (the “Site Plan Approval”) effective February 13, 2018; and

WHEREAS, pursuant to Section 90-20.3 of the Town of Surfside (“Town”) Code of Ordinances (“Code”), the failure to obtain a building permit for a principal building approved by a site plan approval within 24 months of the effective date of site plan approval, renders the approval null and void; and

WHEREAS, Section 90-20.3(1) of the Town Code provides that “extensions for good cause, not to exceed one year for all extensions, may be granted by the Town Commission, at its sole discretion, provided the applicant submits a request in writing to the Town Manager or designee in advance of the expiration date of the original site plan approval, setting forth good cause for such an extension;” and

WHEREAS, in connection with conditional use approvals, Section 90-23.5 of the Town Code, provides “the Town Commission, at its discretion, may grant one or more extensions for a period of up to a total of six months for good cause shown by the applicant;”

WHEREAS, pursuant to Section 90-35(a)(9) of the Town Code, both site plan and conditional use approvals may be granted multiple extensions “for a period of up to a total of six months” by the Town Commission “for good cause shown by the applicant;” and

WHEREAS, prior to the expiration of 24 months from the effective date of the Site Plan Approval, by letter dated February 12, 2020, the Owners through their counsel, John Shubin and Ian DeMello of Shubin Bass, formally requested a one-year extension of time pursuant to Section

90-20.3 of the Town Code asserting “good cause” based on the following “assertions: substitution of architect; market conditions; and site plan changes/parking and program changes” (the “Request for Extension”); and

WHEREAS, in a letter dated May 21, 2020, the Owners through their counsel requested the placement of the Request for Extension on a Town Commission agenda for consideration and asserted the same reasons for good cause advanced previously together with an additional reason based on “various Executive Orders and States of Emergency related to natural disasters;” and

WHEREAS, the May 21, 2020 letter referenced a number of State of Florida and Miami-Dade County Emergency Orders that pre-date the expiration date of the Site Plan Approval, including those for Red Tide, Hurricane Maria, and Hurricane Florence, as well as executive orders relating to COVID-19 that were issued after the original expiration date of the Site Plan Approval; and

WHEREAS, the Town Staff reviewed the Request for Extension and recommended the Town Commission consider the extension of the Site Plan Approval to February 13, 2021; and

WHEREAS, on July 14, 2020, the Town Commission conducted a public hearing on the Application for which a hearing was noticed, posted, advertised and held as required by law, all interested parties concerned in the matter were heard, and due and proper consideration was given to the matter; and

WHEREAS, the Town Commission, having reviewed the Request for Extension, the written and oral findings of Town staff, and all other relevant testimony and evidence, finds that good cause [select one: has / has not been] shown.

NOW, THEREFORE, BE IT RESOLVED BY THE TOWN COMMISSION OF THE TOWN OF SURFSIDE, FLORIDA AS FOLLOWS:

Section 1. Recitals. The above-stated recitals are true and correct and are incorporated herein by this reference.

Section 2. Extension [Approval / Denial]. That the requested extension of the Site Plan Approval pursuant to Section 90-20.3 of the Town Code is hereby [select one: approved / denied] for a period of ____ months to ____ ____, 2020.

Section 3. Original Terms and Conditions. This determination relates solely to an extension of time to the original expiration date of the Site Plan Approval and does not in any way

affect any aspect of the Site Plan Approval or the Resolution, which terms remain unchanged from the original approval.

Section 4. Effective Date. This Resolution shall become effective immediately upon adoption.

PASSED AND ADOPTED on this 14th day of July, 2020.

FINAL VOTE ON ADOPTION

Motion By: _____

Second By: _____

FINAL VOTE ON ADOPTION:

Commissioner Charles Kesl _____

Commissioner Eliana R. Salzhauer _____

Commissioner Nelly Velasquez _____

Vice Mayor Tina Paul _____

Mayor Charles W. Burkett _____

Charles W. Burkett, Mayor

ATTEST:

Sandra Novoa, MMC
Town Clerk

APPROVED AS TO FORM AND LEGALITY FOR THE USE AND BENEFIT OF THE TOWN OF SURFSIDE ONLY:

Weiss Serota Helfman Cole & Bierman, P.L.
Town Attorney



**Town of Surfside
Zoning Code Workshop
AGENDA
June 3, 2020
7 p.m.**

Town Hall Commission Chambers - 9293 Harding Ave, 2nd Floor
Surfside, FL 33154

1. Opening

A. Call to Order

Mayor Burkett called the meeting to order at 7:05 p.m.

B. Roll Call of Members

Town Clerk McCready called the roll with the following members present:

Present: Mayor Charles Burkett, Commissioner Nelly Velasquez and Commissioner Salzhauer.

Absent: Commissioner Charles Kesl, and Vice Mayor Tina Paul.

Also present were Town Manager Guillermo Olmedillo, Town Attorney Lillian Arango and Town Planning Attorney Edward Martos.

2. Discussion Items

A. Discussion on Adoption of a New Zoning Code

Mayor Burkett introduced Wes Blackman and asked Mr. Blackman to assist in reworking the zoning code and for him to share his preservation experience.

Mayor Burkett read his comments into the record.

Wes Blackman, AICP and Senior Urban Planner, spoke about his past experience with other municipalities.

Commissioner Salzhauer asked Mr. Blackman regarding a proposal he submitted and asked if he was hired by the Town.

Mayor Burkett stated that Mr. Blackman was not hired by the Town.

Commissioner Salzhauer stated that this meeting should not have taken place and the focus should be having a Town Planner and a Planning and Zoning Board.

Mr. Blackman stated that he currently lives in Lake Worth and ran for Commission seat twice but was unsuccessful. He stated that he loves the community he lives in and Lake Worth is a middle-class municipality with the lowest income.

Commissioner Salzhauer asked Mr. Blackman how he would see himself interacting with the Town in reference to the 2006 and 2008 zoning code. She stated that there is a need for a solution and this is needed quickly in order for the residents to continue with their construction projects.

Mr. Blackman responded to Commissioner Salzhauer's comments and stated that he was distressed with the May 14, 2020 Meeting and that there is a lack of trust with the consultants. He stated that it is not a good position to be in and they are searching for an objective point of view with a fresh view of things.

Mayor Burkett stated that the intention was not to sell Mr. Blackman as a consultant but to introduce Mr. Blackman and have him provide the support he is able to and then the decision on how to proceed will become clearer.

Mayor Burkett provided his opening remarks on the recount of this meeting, zoning history and guidelines.

Mayor Burkett gave suggestions on how to rectify the zoning code.

Commissioner Salzhauer addressed the comments made by Mayor Burkett and spoke regarding the zoning code being discussed. She commented regarding the side setbacks. She stated that it is necessary to rely on individuals with the expertise needed.

Commissioner Velasquez stated that she agrees with changing the code and going back to the old code. She stated that there are things in the old code that are better than what the Town currently has and they need to do away with over development as well as working on correcting the code.

Commissioner Salzhauer commented on statements made by Commissioner Velasquez regarding the difference in the zoning codes.

Commissioner Velasquez stated that they need a new code that they can trust.

Mayor Burkett provided a presentation discussing the charter amendments that took place.

Commissioner Salzhauer asked what was the difference between units per acre.

Mayor Burkett stated that he will be bringing back all suggested changes.

Town Planner John Hickey addressed questions and comments made by the Commission regarding units per acre.

Commissioner Salzhauer spoke regarding the issue with gross unit per acre.

Mayor Burkett addressed the comments made by Commissioner Salzhauer.

Commissioner Velasquez spoke regarding comments made by the public and the changes discussed regarding the zoning code and the units per acre.

Further discussion took place among the Commission regarding the difference in zoning codes, units per acre and the definition of the acre.

Mr. Blackman clarified the gross acre and units per acre and how the residential areas are measured and answered comments and questions made by the Commission.

Further discussion took place among the Town Commission regarding possible changes to the zoning code and placing it on the November 2020 ballot.

George Kousoulas stated that covered patios do not count towards the area ratio and he explained how to close this loop hole that allows massive construction.

Commissioner Salzhauer spoke regarding the patio area and how it can be addressed.

Discussion took place among the Town Commission regarding the code and what is allowable.

George Kousoulas spoke regarding both codes and the setbacks on the lots.

The Town Commission addressed comments made by speaker George Kousoulas.

Speaker Jeff Rose spoke regarding the covered terraces and additions.

Commissioner Velasquez asked regarding covered patios and the 40% issue.

George Kousoulas spoke regarding the home in question and said restrictions.

Mayor Burkett believes that they should go back to the 2006 Code and take some of George Kousoulas' recommendations and make them part of the old code and discuss item by item within the code and any changes that need to be made.

Speaker Victor Andreu spoke on size and setbacks.

Commissioner Velasquez addressed Mr. Andreu's comments and spoke regarding the beach chairs.

Wes Blackman spoke regarding the municipal zoning codes and the conversation taking place regarding covered patios and asked if there are rules to prevent splitting the lots.

Commissioner Salzhauer would like to explore the other problem areas in the Town and how to address those issues.

Town Planner James Hickey answered the comments made by Commissioner Salzhauer and provided clarification regarding the setbacks in relationship to the Code.

Town Attorney Edwardo Martos commented on the procedures and the criteria being satisfied.

Mayor Burkett commented on the difference between the codes. He stated that he would like to have for the next meeting answers regarding setbacks.

Commissioner Velasquez asked regarding the 10% of frontage.

Town Planner James Hickey answered Commissioner Velasquez' question.

Mayor Burkett closed the meeting to public comments and gave his closing remarks.

Further discussion took place among the Town Commission.

Mayor Burkett requested to obtain what is pertinent and relevant from the old code and add it to the new code by making sure it removes undesirable projects.

Town Planner James Hickey responded to comments made by the Town Commission.

Mayor Burkett commented on having the new code in order and how they want to address the Town Planner situation and possibly bring a temporary Planner in-house.

Commissioner Salzhauer would like to have a process and look at it and see how it occurred and conduct an analysis.

Commissioner Salzhauer thanked the public for submitting applications for the different Committees and Boards.

Mayor Burkett asked what day the next workshop would take place.

Commissioner Salzhauer suggested July 2nd for the next workshop.

Further discussion took place regarding the next Zoning workshop to be July 1, 2020. The Town Commission asked the Town Clerk to have the next workshop scheduled for July 1, 2020.

3. Public Comments

The following members from the public spoke:

George Kousoulas spoke regarding Mr. Blackman and believes that there are improvements that can be done with the zoning code and characterization of the charter amendment and spoke regarding the two codes.

Jeff Rose stated that these types of meetings should take place once we have a Planning and Zoning Board in place and they should keep Mr. Hickey as the Town Planner. He stated that they need to decide on the code and care about the future of the Town of Surfside.

Diana Gonzalez stated that one should be respectful and have knowledge of the code and to do away with what was approved by the previous commission.

Mayor Burkett addressed the comments made by speaker George Kousoulas regarding the charter position.

Commissioner Velasquez addressed the comments made by public speaker Diana Gonzalez and that any changes that are done are in the best interest of the residents of Surfside in order to go back to something that they would trust.

Deputy Town Clerk Herbello read public speaker Jeffrey Platt's email into the record

4. Adjournment

There being no more business to be discussed at the workshop, the meeting adjourned without objection at 10:07 pm.

Accepted this _____ day of _____, 2020.

Charles W. Burkett, Mayor

Attest:

Sandra N. McCready, MMC
Town Clerk



**Town of Surfside
Regular Town Commission Meeting
MINUTES
June 9, 2020
7 p.m.**

Town Hall Commission Chambers - 9293 Harding Ave, 2nd Floor
Surfside, FL 33154

1. Opening

A. Call to Order

Mayor Burkett called the meeting to order at 7:06 p.m.

B. Roll Call of Members

Town Clerk McCready called the roll with the following members present:

Present: Mayor Charles Burkett, Vice Mayor Tina Paul, Commissioner Nelly Velasquez, Commissioner Eliana Salzhauer and Commissioner Charles Kesl.

Also present were Town Manager Guillermo Olmedillo and Town Attorney Lillian Arango.

C. Pledge of Allegiance

D. Mayor and Commission Remarks – Mayor Charles W. Burkett

No remarks made.

E. Agenda and Order of Business Additions, deletions and linkages

F. Community Notes – Mayor Charles W. Burkett

No community notes.

2. Quasi-Judicial Hearings – N/A

3. Consent Agenda (Set for approximately 7:30 p.m.)

A motion was made by Vice Mayor Paul to approve the consent agenda minus the pulled items, seconded by Commissioner Kesl. All voted in favor.

A. Minutes – Sandra N. McCready, MMC, Town Clerk

- *May 5, 2020 Budget Workshop Meeting Minutes*
- *May 12, 2020 Regular Town Commission Meeting Minutes*
- *May 14, 2020 Special Town Commission Meeting Minutes*
- *May 26, 2020 Special Town Commission Meeting Minutes*

Vice Mayor Paul would like to pull the May 26, 2020 Special Town Commission Meeting Minutes and stated that on page 48, it was requested that the item regarding construction be placed on this agenda and this needs to be addressed regarding the plans received.

Town Manager Olmedillo stated that he will be addressing the item regarding construction during his Town Manager's Report.

A motion was made by Vice Mayor Paul to approve the May 5, 2020 Budget Workshop Meeting Minutes, May 12, 2020 Regular Town Commission Meeting Minutes, May 14, 2020 Special Town Commission Meeting Minutes and the May 26, 2020 Special Town Commission Meeting Minutes, seconded by Commissioner Kesl. All voted in favor.

Commissioner Kesl would like to pull item 3F for purposes of discussion and have it heard after the Resolutions.

A motion was made by Commissioner Salzhauer to move item 3F to be discussed before the ordinances, seconded by Vice Mayor Paul. All voted in favor.

***B. Town Manager's Report** – Guillermo Olmedillo, Town Manager

Town Manager Guillermo Olmedillo gave his report and advised of the beach opening tomorrow and spoke regarding the beach ambassadors being present.

Town Manager Guillermo Olmedillo discussed 25 applicants for the Town Manager position have been received and are being reviewed.

Town Manager Olmedillo spoke regarding Building Official Prieto's construction plan.

Town Manager Olmedillo spoke regarding the request of the CGA payments for services that have been provided and the Town has to decide on how to treat that.

Town Manager Olmedillo spoke regarding the tri-city shuttle which is item 9ZZ.

Town Manager Olmedillo sent the June 1st estimated property value and stated that it was reduced from previous years.

Commissioner Kesl stated that he wanted to commend Town Manager Olmedillo on the safety improvements on Collins Avenue and the amount of work done. He asked regarding item number 2, the crosswalk in Harding Avenue and FDOT and ADA compliance.

Mayor Burkett spoke regarding a police incident and speeding in Surfside.

Commissioner Kesl spoke regarding Rachel Pinzur's amendment, which is part of the Town Manager's Report and stated that the print was very small and hard to read.

Mayor Burkett stated that is the status of all the pending and completed projects in the Town.

Vice Mayor Paul asked when they will discuss the construction.

Mayor Burkett state that it will be discussed under COVID-19 item.

***C. Town Attorney's Report** – Weiss Serota, Town Attorney

Town Attorney Arango stated that all the information is in her report.

D. Committee Reports – Guillermo Olmedillo, Town Manager – ***None at this time***

E. 2020 Town Meeting Calendar – Sandra N. McCready, MMC, Town Clerk

F. Resolution renaming the Town's Higher Education Scholarships to be called the "Arya Gray Memorial Higher Education Scholarships –
Commissioner Eliana Salzhauer

A RESOLUTION OF THE TOWN COMMISSION OF THE TOWN OF SURFSIDE, FLORIDA, HONORING ARYA GRAY AND DIRECTING THE TOWN MANAGER TO IMPLEMENT CHANGES TO THE TOWN'S SUMMER CAMP AND SCHOLARSHIP PROGRAMS AND INSTALL A MEMORIAL PAVER IN HONOR OF ARYA GRAY; PROVIDING FOR IMPLEMENTATION; AND PROVIDING FOR AN EFFECTIVE DATE.

Commissioner Salzhauer introduced the item and what is important in our community.

Commissioner Salzhauer introduced Arya Gray's uncle, Walter Javier.

Public speaker, Walter Javier, Arya Gray's uncle addressed the Commission and stated that everyone should give back to the community and thanked the Commission.

The following members of the public spoke on the item:
Ellen Abramson

Commissioner Salzhauer addressed the comments made by the public speakers and the issues being faced with gun safety.

Vice Mayor Paul spoke regarding the memorial held in front of the family's home.

Commissioner Kesl commented on the circumstances of this horrific situation.

Commissioner Salzhauer wanted to correct the record of when she passed and spoke regarding her being an innocent victim and feels that this is important that someone can go to college in her name. She stated the importance of proper and adequate counseling for mental health.

Commissioner Kesl spoke regarding the importance of properly educating children and speaking to a counselor. He requested that this scholarship go to a student studying something that has a connection to mental health.

Commissioner Salzhauer stated that the scholarship named after Arya Gray to include an essay question on gun safety, what they are looking to do in their personal life and studies on that topic.

Commissioner Kesl suggested renaming the scholarship where it states saving our children.

Commissioner Salzhauer addressed the suggestion made by Commissioner Kesl and stated many of the children do not know what they want to major in.

Commissioner Velasquez asked what the essay question would be.

Commissioner Salzhauer answered Commissioner Velasquez question that the question should be something to do with guns safety in America and what that applicant intends to do with accidental gun death.

Mayor Burkett asked if there is a fixed amount of monies for scholarships.

Finance Director Greene stated that it is two (2) \$1,000 scholarships.

Mayor Burkett commented on the dollar amounts of the scholarships and the criteria for those scholarships.

Vice Mayor Paul addressed the comments made by Mayor Burkett and stated that it is two (2) \$1,000 scholarships for high school students going into college to assist them and there are criteria to qualify for the scholarships.

Commissioner Salzhauer elaborated on the higher education scholarship which comes out of Tourism monies going to residents.

The following individual from the public spoke on the item:
Sheryl Goldberg

Mayor Burkett would like to see it read to have a paver to honor her memory, gun safety and education and if those changes could be made, he would agree.

A motion was made by Commissioner Salzhauer to approve the Resolution, seconded by Vice Mayor Paul. All voted in favor with Commissioner Kesl, Commissioner Velasquez and Mayor Burkett voting against. The motion failed.

Commissioner Salzhauer stated this is the saddest thing and embarrassed for the Town that the Commission does not renaming the scholarship in her name, nor get gun safety education in and have the pavers.

Further discussion took place on the new language and keeping the resolution intact except naming the scholarship after Arya Gray.

A motion was made by Commissioner Velasquez to amend the Resolution leaving the name at the Town of Surfside Higher Education Scholarship and adding a gun safety and education component, seconded by Commissioner Kesl. All voted in favor.

Further discussion took place among the Commission on the item.

A motion was made by Commissioner Salzhauer to bring back the original Resolution as is and add the nexus of writing an essay on gun violence, seconded by Vice Mayor Paul. All voted in favor.

4. Ordinances

(Set for approximately 8:00 p.m.) (Note: Good and Welfare must begin at 8:15)

A. Second Reading Ordinances

1. Planning and Zoning Board Membership Requirements – Guillermo Olmedillo, Town Manager

AN ORDINANCE OF THE TOWN COMMISSION OF THE TOWN OF SURFSIDE, FLORIDA, AMENDING SECTION 90-15 OF CHAPTER 90, "ZONING", OF THE TOWN CODE TO REQUIRE ONE MEMBER OF THE PLANNING AND ZONING BOARD TO HAVE EDUCATION AND/OR EXPERIENCE IN SUSTAINABILITY AND RESILIENCY; PROVIDING FOR CODIFICATION; PROVIDING FOR SEVERABILITY; PROVIDING FOR CONFLICTS; PROVIDING FOR INCORPORATION OF RECITALS; AND PROVIDING FOR AN EFFECTIVE DATE.

Town Clerk McCready read the title of the Ordinance into the record.

A motion was made by Vice Mayor Paul, to approve the Ordinance on second reading, seconded by Commissioner Salzhauer. All voted in favor.

Mayor Burkett stated that he believes that demanding that residents have expertise in order to sit on the Board is probably not the best thing since they will have other expertise. He believes it will eliminate people from serving on the boards whose opinions are just as important. He believes it is arbitrary and not necessary.

Commissioner Velasquez stated that they tried to dismantle some of the committees in an effort to save monies. She stated that instead of dismantling the Sustainability & Resiliency which have not spent that much money, to bring back that committee and eliminate the Tourist Board and combine the Parks and Recreation with the Tourist Board.

Commissioner Salzhauer stated that this issue has already been discussed and this is a second reading and this should just move forward and continue with the other items on the agenda.

Commissioner Kesl stated that it is not bad to revisit issues. He commented on the boards and committees and appointments with certain expertise.

Mayor Burkett opened the floor to public comments.

The following individuals spoke on the item:

Jeff Rose

Ellen Abramson

Mayor Burkett closed the floor to public comments.

2. Tourist Board Members Requirements - Guillermo Olmedillo, Town Manager

AN ORDINANCE OF THE TOWN COMMISSION OF THE TOWN OF SURFSIDE, FLORIDA, AMENDING SECTION 70-124, OF DIVISION 2.-“RESORT TAX BOARD”, OF ARTICLE IV.-“RESORT TAX”, CHAPTER 70 OF THE TOWN CODE, TO REQUIRE ONE MEMBER OF THE RESORT TAX BOARD TO HAVE EDUCATION AND/OR EXPERIENCE IN SUSTAINABILITY AND RESILIENCY; PROVIDING FOR CODIFICATION; PROVIDING FOR SEVERABILITY; PROVIDING FOR CONFLICTS; PROVIDING FOR INCORPORATION OF RECITALS; AND PROVIDING FOR AN EFFECTIVE DATE.

Town Clerk McCready read the title of the Ordinance into the record.

A motion was made by Commissioner Kesl to approve the Ordinance on second reading, seconded by Commissioner Salzhauer. All voted in favor.

Commissioner Salzhauer spoke regarding what the Board would be required to do.

Commissioner Kesl commented on the past meetings and at times it being unproductive and what the Committee’s responsibilities would be.

Commissioner Velasquez asked where the monies are going and being spent on and wants to make sure that the monies are being placed in the correct areas as well as where they are being spent.

Town Attorney Arango addressed the question made by Commissioner Velasquez and stated that they are allowed to spend 34% of the Tourist Board monies and the expenditures and budget must be approved by the Town Commission.

Commissioner Velasquez asked how can they make sure what exactly the Tourist Board monies are being spent on and believes it should be approved by the Commission.

Vice Mayor Paul stated that the Tourist Board issue was how it was being guided and some of the board members felt pushed into making decisions and it came from the previous Director of Tourism.

Commissioner Kesl commented on the Tourist Board and suggestions made by previous members of the Board and at times things were not

clear and it aggravated some board members.

Commissioner Kesl commented on the conversation he had with the vendor for the Christmas Lights and Tourism Bureau Director Frank Trigueros and felt it was a productive conversation.

Commissioner Salzhauer stated that she agrees that what happened in the past was a lack of direction and attitude and making sure the person they appoint shares the same vision.

Commissioner Velasquez stated that she wants to make sure the monies are well spent and benefit the residents of the Town and would like the Commission to be able to see what the expenses will be before they are spent.

Commissioner Kesl stated that this is where the planning, quality control and standardization comes into place. He commented on the item he has on the agenda that keeps being moved back on the agenda and others being moved up. He addressed the construction and the importance of this issue and it has been a great distraction.

Further discussion took place among the Town Commission on items being moved up on the agenda and which ones should be prioritized.

(Set for approximately N/A p.m.) (Note: Good and Welfare must begin at 8:15)

B. First Reading Ordinances

5. Resolutions and Proclamations

(Set for approximately 9:00 p.m.) (Note: Depends upon length of Good and Welfare)

A. Combat Hateful Actions COVID-19 Resolution – Vice Mayor Tina Paul

A RESOLUTION OF THE TOWN COMMISSION OF THE TOWN OF SURFSIDE, FLORIDA, DECLARING A COMMITMENT TO PROTECT THE SAFETY AND WELFARE OF ALL COMMUNITY MEMBERS AND TO COMBAT HATEFUL ACTIONS DUE TO THE COVID-19 HEALTH PANDEMIC; PROVIDING FOR IMPLEMENTATION; AND PROVIDING FOR AN EFFECTIVE DATE.

Town Clerk McCready read the title of the resolution into the record.

Vice Mayor Paul introduced the item.

Commissioner Velasquez commented that all religions, genders and ethnicity should have been included.

Mayor Burkett commented that Christians were not included.

Vice Mayor Paul addressed the comments made by the Commission.

Commissioner Velasquez stated that she sees this as discrimination.

Vice Mayor Paul stated that it includes all groups and it is not discriminatory.

Mayor Burkett read his statement into the record attached as Exhibit "1".

Commissioner Salzhauer addressed the comments made by Mayor Burkett and stated that the comments made by Mayor Burkett were not accurate.

Commissioner Salzhauer read her comments into the record attached as Exhibit "2".

Further discussion took place among the Commission regarding this item.

Vice Mayor Paul continued explaining her item and the discrimination taking place in the Town.

Commissioner Kesl commented on the item and stated the cultural differences and no one wants discrimination.

Mayor Burkett addressed Commissioner Salzhauer's comments.

Mayor Burkett asked Vice Mayor Paul if they can add all the other groups.

Vice Mayor Paul stated that she would like her Resolution to stay the way it is currently written.

Commissioner Velasquez stated that she would like to apologize to Arya Gray's family.

The following individual spoke on the item:
Deborah Cimadevilla

Commissioner Salzhauer addressed speaker Deborah Cimadevilla's comments.

A motion was made by Vice Mayor Paul, to approve the Resolution as written, seconded by Commissioner Kesl. All voted in favor with Commissioner

Velasquez voting against.

B. Inclusive/Nondiscriminatory Resolution regarding COVID-19 Hate and Blame – Mayor Charles W. Burkett

A RESOLUTION OF THE TOWN COMMISSION OF THE TOWN OF SURFSIDE, FLORIDA, DECLARING A COMMITMENT TO PROTECT THE SAFETY AND WELFARE OF ALL COMMUNITY MEMBERS AND TO COMBAT HATEFUL ACTIONS DUE TO THE COVID-19 HEALTH PANDEMIC; PROVIDING FOR IMPLEMENTATION; AND PROVIDING FOR AN EFFECTIVE DATE.

Town Clerk McCready read the title of the resolution into the record.

Mayor Burkett introduced the item.

Commissioner Kesi stated that the title connotes some satire in the title and is rhetorical.

Further discussion took place among the Town Commission on the item.

A motion was made by Commissioner Velasquez to approve the Resolution, seconded by Mayor Burkett. All voted in favor with Commissioner Salzhauer, Commissioner Kesi and Vice Mayor Paul voted against. The motion failed.

C. Police Body-Worn Camera System - Guillermo Olmedillo, Town Manager

A RESOLUTION OF THE TOWN COMMISSION OF THE TOWN OF SURFSIDE, FLORIDA APPROVING THE PURCHASE OF A POLICE BODY-WORN CAMERA SYSTEM AND ASSOCIATED HARDWARE, LICENSING AND VIDEO STORAGE SOFTWARE FOR THE POLICE DEPARTMENT FROM AXON ENTERPRISE, INC.; FINDING THAT THE PURCHASE IS EXEMPT FROM COMPETITIVE BIDDING PURSUANT TO SECTION 3-13(3) OF THE TOWN CODE; AUTHORIZING THE TOWN MANAGER, POLICE CHIEF AND TOWN ATTORNEY TO NEGOTIATE, FINALIZE AND EXECUTE A MASTER SERVICES AND PURCHASING AGREEMENT FOR A FIVE YEAR TERM FOR SUCH PURCHASE; PROVIDING FOR IMPLEMENTATION; AND PROVIDING FOR AN EFFECTIVE DATE.

Town Clerk McCready read the title of the resolution into the record.

Vice Mayor Paul asked who will be the system's administrator and requested from Town Manager Olmedillo what other municipalities in Dade County have the Axon body cameras.

Police Chief Yero responded to Vice Mayor Paul's question and stated that the majority of Miami Dade County agencies have Axon body worn cameras.

Vice Mayor Paul asked if Bal Harbor and Bay Harbour had it.

Police Chief Yero stated that those two municipalities did not have body worn cameras due to the cost.

Vice Mayor Paul stated that her concern was the cost and the cost of the maintenance level for it.

Mayor Burkett stated that due to the what is occurring now, it is necessary.

Further discussion took place regarding the item among the Commission.

A motion was made by Commissioner Velasquez, to approve the Resolution, seconded by Commissioner Salzhauer. All voted in favor with Vice Mayor Paul voting against.

D. CARES ACT Fund – Guillermo Olmedillo, Town Manager

A RESOLUTION OF THE MAYOR AND THE TOWN COMMISSION OF THE TOWN OF SURFSIDE, FLORIDA, URGING MIAMI-DADE COUNTY MAYOR CARLOS A. GIMENEZ AND THE BOARD OF COUNTY COMMISSIONERS OF MIAMI-DADE COUNTY, FLORIDA TO TRANSFER CORONAVIRUS AID, RELIEF, AND ECONOMIC SECURITY (CARES) ACT DIRECT FEDERAL FUNDS RECEIVED BY MIAMI-DADE COUNTY TO THE TOWN OF SURFSIDE AND TO OTHER UNITS OF LOCAL GOVERNMENT WITHIN THE COUNTY BASED ON POPULATION AND RATES OF COVID-19 CASES; PROVIDING FOR TRANSMITTAL; AND PROVIDING FOR AN EFFECTIVE DATE.

Town Clerk McCready read the title of the resolution into the record.

Town Manager Olmedillo introduced the item.

A motion was made by Vice Mayor Paul to approve the Resolution, seconded by Commissioner Velasquez. All voted in favor.

E. FY 2020 Budget Amendment - Guillermo Olmedillo, Town Manager

A RESOLUTION OF THE TOWN COMMISSION OF THE TOWN OF SURFSIDE, FLORIDA, APPROVING BUDGET AMENDMENT NO. 6 FOR THE FISCAL YEAR 2020 BUDGET; PROVIDING FOR IMPLEMENTATION; AND PROVIDING FOR AN EFFECTIVE DATE.

Town Clerk McCready read the title of the resolution into the record.

Town Manager Olmedillo introduced the item.

Mayor Burkett asked if it is the fiscal year that we are currently in right now.

Town Manager Olmedillo stated yes, it ends in September 2020 and it was not included in the existing budget.

Commissioner Velasquez asked where this pump is going.

Public Works Director Stokes stated that this is a pump is going into our sewer system lift stations.

A motion was made by Commissioner Velasquez, to approve the Resolution, seconded by Vice Mayor Paul. All voted in favor.

F. Purchase of Additional Sewer Pump – Guillermo Olmedillo, Town Manager

A RESOLUTION OF THE TOWN COMMISSION OF THE TOWN OF SURFSIDE, FLORIDA APPROVING THE PURCHASE OF A BACK-UP PUMP FOR SANITARY SEWER LIFT STATIONS FROM BARNEY’S PUMPS INC.; FINDING THAT THE PURCHASE IS EXEMPT FROM COMPETITIVE BIDDING PURSUANT TO SECTION 3-13(7)F OF THE TOWN CODE AS A PUBLIC WORKS OR UTILITIES PURCHASE OF EQUIPMENT; AUTHORIZING THE TOWN MANAGER TO ENTER INTO A PURCHASE ORDER FOR SUCH PURCHASE; PROVIDING FOR IMPLEMENTATION; AND PROVIDING FOR AN EFFECTIVE DATE.

Town Clerk McCready read the title of the resolution into the record.

Town Manager Olmedillo introduced the item.

Commissioner Velasquez asked why is there an exemption for competitive bidding.

Public Works Director Stokes stated it is a sole source and this pump is specific to a certain panel and there is only one provider available that provides the equipment necessary.

A motion was made by Vice Mayor Paul, to approve the Resolution, seconded by Commissioner Velasquez. All voted in favor.

G. COVID-19 Anti-Hate Resolution to Include Hispanics and Latinos – Commissioner Nelly Velasquez

A RESOLUTION OF THE TOWN COMMISSION OF THE TOWN OF SURFSIDE, FLORIDA, DECLARING A COMMITMENT TO PROTECT THE SAFETY AND WELFARE OF ALL COMMUNITY MEMBERS AND TO COMBAT HATEFUL ACTIONS DUE TO THE COVID-19 HEALTH PANDEMIC; PROVIDING FOR IMPLEMENTATION; AND PROVIDING FOR AN EFFECTIVE DATE.

Town Clerk McCready read the title of the resolution into the record.

Commissioner Velasquez withdrew this Resolution.

**6. Good and Welfare/ Public Comments from Residents
(Set for approximately 8:15 p.m.)**

Public comments for subjects or items not on the agenda. Public comment on agenda items will be allowed when agenda item is discussed by the Commission.

The following individuals from the public spoke:

Councilman Jordan Leonard spoke regarding item 9ZZ, interlocal shuttle system, which he started in order to have a more sustainable system and requested approval.

Commissioner Velasquez advised Councilman Leonard that it was passed by the last Commission.

Vice Mayor Paul addressed the comments made and asked the Town Manager Olmedillo what happened to this RFP.

Town Manager Olmedillo addressed the comments made and stated that they were looking for confirmation and have someone to do the RFP.

Commissioner Velasquez asked if someone from staff could do the RFP.

Town Manager Olmedillo stated that this is an expertise RFP that someone with knowledge in that specific area would need to write the RFP and the Town does not have that expertise in staff. Town Manager Olmedillo stated he is seeking

assistance to bring it back to the Town.

Commissioner Velasquez stated that if they would hire someone to prepare the RFP, how long would it take for them to prepare the RFP.

Town Manager Olmedillo stated that they would have to go out to market to see who would be able to prepare the RFP.

Finance Director Greene stated that he is not sure how much it would cost to bring someone in to prepare the RFP. He stated that the former Assistant Town Manager was in the process to start the RFP but they will need assistance from a transportation and engineering expert and monies are funded for that. He explained the different steps regarding this item as it relates to the RFP. He stated that the CTT would have to be amended as well as the MOU and the execution of the FDOT agreement.

Commissioner Velasquez asked why the RFP was put on us to prepare and not the other Towns.

Town Manager Olmedillo addressed the comment made by Commissioner Velasquez and stated that the Town took the initiative because the other Towns did not take the lead.

Mayor Burkett stated that he spoke with Councilman Leonard and needed clarification.

Vice Mayor Paul asked how fast they can have the RFP done.

Commissioner Salzhauer stated that they are not allowed to make motions on good welfare, that they would need to move item 9ZZ up on the agenda to be heard.

A motion was made by Commissioner Velasquez to move item 9ZZ up on the agenda right after the construction item 9A, seconded by Commissioner Kesl. All voted in favor.

The following individuals spoke on Good and Welfare:

Zoya Javier spoke regarding her position as a Committee Member of Parks and Recreation and the comments made by the Commission regarding the scholarship to be named after her niece, Arya Gray.

Jeff Rose commented on when will there be an in-person meeting and when construction on condominiums will be allowed again; when will there be a Planning and Zoning Board meeting.

David Carmona spoke regarding the Javier family and the loss of Arya Gray and it baffles him that some of the Commissioners do not know about the event and they should rename that one (1) scholarship after Arya Gray.

Adam Ohayon spoke regarding allowing him to continue construction.
Arlene Amargos spoke regarding construction and the number of employees allowed to work outside and the limit of 8 workers outside is placing a burden on them.
Diana Gonzalez spoke regarding moving forward on all points and getting through the agenda and focus on priorities.

Mayor Burkett addressed the comment made by public speaker Zoya Javier and stated that he was not familiar with the scholarship program. He stated that he would recommit and bring it back with language that everyone is comfortable with.

Commissioner Kesl stated that he would like this to have meaning.

Commissioner Salzhauer stated that she would like to have the essay to be added and reconsidered. She stated that what matters is having the scholarship named after her which has a meaning and possibly revisit it tonight.

Mayor Burkett closed Good and Welfare.

7. Town Manager and Town Attorney Reports

Town Manager and Town Attorney Reports have been moved to the Consent Agenda – Item 3.

8. Unfinished Business and New Business

9. Mayor, Commission and Staff Communications

A. COVID-19 Task Force Update – Mayor, Vice Mayor and Members of the Town Commission

A motion was made by Commissioner Velasquez to move the construction item and shuttle bus item 9ZZ to be heard before item 5A, seconded by Vice Mayor Paul. All voted in favor with Commissioner Kesl and Commissioner Salzhauer voting no.

Commissioner Kesl spoke regarding the Code of Care and that should be continued and to add a section at the bottom of the Town's proposal which Building Official Prieto and Town Manager Olmedillo came up with. He believes the goal is to come up with the Code of Care and be in alignment with the County and protect the Town residents from COVID.

Commissioner Kesl commented for the condominiums to come up with a sanitation plan and abide by those rules. He spoke regarding the time of construction and have them posted to be clear so everyone knows their expectations. He spoke regarding the construction workers space and for this not to be amended in the future.

Vice Mayor Paul commented on the fact that the projects should be submitting their plans to Building Official Prieto and it is time to put construction back in the hands of Building Official Prieto.

A motion was made by Commissioner Kesl to eliminate all emergency orders, and keep the code of conduct of construction.

Mayor Burkett asked for clarification on what Commissioner Kesl is requesting.

Further discussion took place among the Commission regarding the Code of Conduct and the restrictions.

Town Attorney Arango clarified the Code of Conduct and their restrictions.

Vice Mayor Paul spoke regarding the Code of Conduct and that the plans submitted to our Building Official Prieto are important and we want the workers to come into the Town to work and be respectful of the rules.

Commissioner Kesl addressed the comments made and he stated that he was working with the Town on the Code of Care.

Commissioner Salzhauer commented on the construction and what the restrictions would be. She also stated the severity of the deaths due to COVID and the affects that this would bring to the Town.

Vice Mayor Paul spoke regarding the construction plan and what is needed at these projects and that Building Official Prieto is familiar with this.

Building Official Prieto addressed the Commission on the requirements on the Code of Care Plan. He read the work hours are currently 9:00 am to 5:00 pm; personal responsibility and CDC requirements, taking temperature; social distancing (4 workers in residential and 8 in businesses), sanitation stations; hoist and elevators; limit the number of workers in there at any one time; time/lunch and breaks and other requirements.

After further discussion regarding the construction and the Code of Care plan, the following of motion was made.

A motion was made by Commissioner Kesl to go with the County rules, do away with all the Emergency Orders and to follow the Code of Conduct to remove the restrictions on the workers and the work hours for construction work, seconded by Commissioner Velasquez. All voted in favor with Commissioner Salzhauer voting against.

Commissioner Kesl provided an update on the COVID-19 Task Force and commented on the rising number of cases.

Sustainability and Resiliency Officer Kate Stein gave an update on the Task Force.

B. Brightview Agreement (FKA Luke's Landscape) Report and Follow up- Staff Report – Guillermo Olmedillo, Town Manager

Deferred to the next meeting.

C. Reconsideration of the Installation of Berms on 92nd Street - Vice Mayor Tina Paul

Deferred to the next meeting.

D. Miami Christmas Lights – Guillermo Olmedillo, Town Attorney

Deferred to the next meeting.

E. Staffing Hiring Freeze – Commissioner Eliana Salzhauer

Deferred to the next meeting.

F. New Zoning Code- Procedural and Notice Requirements – Mayor Charles W. Burkett

Deferred to the next meeting.

G. 92nd St Beach-end Improvements - Mayor Charles W. Burkett

Deferred to the next meeting.

H. Rope Fencing & Posts-Beachwalk/Hardpack - Mayor Charles W. Burkett

Deferred to the next meeting.

I. Develop Capital Improvement Plan (CIP) - Mayor Charles W. Burkett

Deferred to the next meeting.

J. 10 Year Water Supply Plan - Mayor Charles W. Burkett

Deferred to the next meeting.

K. Various Parks & Recreation Related Events and Initiatives – Mayor Charles W. Burkett

Deferred to the next meeting.

L. Building Department File Digitization – Mayor Charles W. Burkett

Deferred to the next meeting.

M. Pinzur Communication – Mayor Charles W. Burkett

Deferred to the next meeting.

N. Preservation of Eden Project located at 9300 Collins Avenue - Mayor Charles W. Burkett

Deferred to the next meeting.

O. Speeding on Collins and Harding - Mayor Charles W. Burkett

Deferred to the next meeting.

P. Amending Town Code Section 2-205 Conduct of Meetings; Agenda – Mayor Charles W. Burkett

Deferred to the next meeting.

Q. Homeless Contribution by the Town of Surfside of \$100,000 - Mayor Charles W. Burkett

Deferred to the next meeting.

R. Free (hassle-free) downtown parking for residents - Mayor Charles W. Burkett

Deferred to the next meeting.

- S. Charter Amendments to affirm the limit of pay for elected officials to a maximum of \$1 per year, term limits for elected officials of 3 consecutive terms, or any part thereof, for both Mayor & Commissioners, a prohibition on the sale or leasing of any Town property without a referendum & a prohibition against any loan or borrowing of any type, which would put the Town into debt for more than 10% of its annual property tax revenue and which could not be fully amortized within a total of 5 years and restore development protections in the charter-** Mayor Charles W. Burkett

Deferred to the next meeting.

- T. Records Retention Policy** – Mayor Charles W. Burkett

Deferred to the next meeting.

- U. Regulation of Short-Term Rentals** – Mayor Charles W. Burkett

Deferred to the next meeting.

- V. Star Cleaning service (Street Sweeping)** – Mayor Charles W. Burkett

Deferred to the next meeting.

- W. S.M.A.R.T Goals, Quality Control & Quality Assurance** – Commissioner Charles Kesl

Deferred to the next meeting.

- X. Design Review Board Discussion – Staff Report** – Guillermo Olmedillo, Town Manager

Deferred to the next meeting.

- Y. Weiss Serota Contract Follow up – Staff Report** – Guillermo Olmedillo, Town Manager

Deferred to the next meeting.

Z. Town Pension Benefits for Non-Public Safety Employees – Mayor Charles W. Burkett

Deferred to the next meeting.

AA. Additional lighting in the residential area – Staff Report – Guillermo Olmedillo, Town Manager

Deferred to the next meeting.

BB. Construction Guidelines for Hurricane Season – Commissioner Nelly Velasquez

Deferred to the next meeting.

CC. Lowering of Property Taxes and Water Bills – Staff Report – Guillermo Olmedillo, Town Manager

Deferred to the next meeting.

DD. CGA Contract Follow Up – Staff Report – Guillermo Olmedillo, Town Manager

Deferred to the next meeting.

EE. Discussion Regarding Appointments to Committees and Boards – Sandra N. McCready, Town Clerk

Deferred to the next meeting.

FF. Downtown Lighting RFP – Mayor Charles W. Burkett

Deferred to the next meeting.

GG. Undergrounding power lines – Staff Report – Guillermo Olmedillo, Town Manager

Deferred to the next meeting.

HH. Dog Park – Mayor Charles W. Burkett

Deferred to the next meeting.

II. FPL Solar Together Program - Vice Mayor Tina Paul

Deferred to the next meeting.

JJ. Climate Environmental Collective - Revised - Vice Mayor Tina Paul

Deferred to the next meeting.

KK. Interest Free Loans to Surfside Builders Granted by Former Mayor and Commission – Mayor Charles W. Burkett

Deferred to the next meeting.

LL. How our Zoning Protections Against Over-Development Were Gutted - Mayor Charles W. Burkett

Deferred to the next meeting.

MM. Amending Town Code Section 2-233 to Include Non-for-Profit – Mayor Charles W. Burkett

Deferred to the next meeting.

NN. Amending Town Code Section 2-237 Business Relationships – Commissioner Eliana Salzhauer

Deferred to the next meeting.

OO. Speeding & Stop Sign Running - Commissioner Eliana Salzhauer

Deferred to the next meeting.

PP. Surfside Point Lake Subaqueous WM Crossing - Bid Documents – Guillermo Olmedillo, Town Manager

Deferred to the next meeting.

QQ. Beachwalk Trimming- Staff Report – Guillermo Olmedillo, Town Manager

Deferred to the next meeting.

RR. Pool Deck Lighting for Extended Winter Hours- Staff Report – Guillermo Olmedillo, Town Manager

Deferred to the next meeting.

SS. Community Center Second Floor – Staff Report - Guillermo Olmedillo, Town Manager

Deferred to the next meeting.

TT. Streamline Town Staffing – Commissioner Eliana Salzhauer

Deferred to the next meeting.

UU. Repeal of Ordinance No. 17-1662 Beach Furniture – Mayor Charles W. Burkett

Deferred to the next meeting.

VV. Replace Ordinance No. 17-1662 Beach Furniture with New Beach Furniture Ordinance – Commissioner Eliana Salzhauer

Deferred to the next meeting.

WW. Designated (Painted) Walking Areas in the Residential District- Staff Report – Guillermo Olmedillo, Town Manager

Deferred to the next meeting.

XX. Procurement Expertise – Commissioner Eliana Salzhauer

Deferred to the next meeting.

YY. Take Home Vehicles - Commissioner Eliana Salzhauer

Deferred to the next meeting.

ZZ. Interlocal Shuttle System Report Update – Guillermo Olmedillo, Town Manager

Town Manager Olmedillo introduced the item and the RFP process and stated that this replaces the present service.

Vice Mayor Paul stated this would service all three communities and an on-demand service of sorts and funding comes from the ½ penny sales tax and does not cost the Town any monies.

A motion was made by Commissioner Velasquez to approve the RFP process, seconded by Vice Mayor Paul. All voted in favor.

AAA. Recent and Significant Increase in Boat, Paddleboard and Kayak Use on Point Lake – Mayor Charles W. Burkett

Deferred to the next meeting.

BBB. Comparison of 2006 Code to 2020 Code – Staff Report – Guillermo Olmedillo, Town Manager

Deferred to the next meeting.

Thirty (30) Day Staff Report – Items from March 24, 2020 Special Town Commission Meetings – COMPLETED

Thirty (30) Day Staff Report – Items from March 31, 2020 Special Town Commission Meetings – COMPLETED

Thirty (30) Day Staff Report – Items from April 7, 2020 Special Town Commission Meetings – COMPLETED

Thirty (30) Day Staff Report – Items from April 16, 2020 Regular Town Commission Meetings – COMPLETED

Thirty (30) Day Staff Report – Items from April 21, 2020 Regular Town Commission Meetings

- A. Stormwater Masterplan - Staff Report – Guillermo Olmedillo, Town Manager**

Thirty (30) Day Staff Report – Items from April 28, 2020 Regular Town Commission Meetings

- A. Beach Preservation Initiatives (“Carry On-Carry Off”/ Clean-Ups/ Chair-Free Safe Space Behind Community Center) - Commissioner Eliana Salzhauer**
- B. Securing Power Infrastructure: Timely Action Plan for Hurricane Season through accountability now by FPL, ATT and Atlantic Broadband – Commissioner Charles Kesl**

Items Completed or Removed from Previous Agendas

- A. Resolution Adopting an Amended Resiliency Reserve Policy Revision**
- B. Resolution Approving the March 17, 2020 Town of Surfside Municipal Election**
- C. Resolution Abolishing the Sustainability and Resiliency Committee**
- D. Resolution Amending the Downtown Vision Advisory Committee**
- E. Resolution Reauthorizing the Parks and Recreation Committee**
- F. “Flash Your Lights” - Commissioner Eliana Salzhauer**
- G. Mandatory Face Mask in the Town of Surfside – Commissioner Nelly Velasquez**
- H. Bandanas for Town Residents – Commissioner Eliana Salzhauer**
- I. Commission Meeting Starting Time at 6:00pm – Mayor Charles W. Burkett**
- J. Discussion Regarding Assistant Town Manager position and Action -
Commissioner Nelly Velasquez**
- K. Photovoltaic RFP - Mayor Charles W. Burkett**
- L. Facilities Review - Mayor Charles W. Burkett**
- M. Kayak Launch - Mayor Charles W. Burkett**
- N. Jacober Contract – Mayor Charles W. Burkett**
- O. Zambelli Fireworks Manufacturing - Mayor Charles W. Burkett**
- P. Small Business Survival Grant - Vice Mayor Tina Paul**
- Q. Review of Amendment No. 2 to Update No. 5 Town of Surfside Emergency Measures – Vice Mayor Tina Paul**
- R. Downtown Surfside Sidewalk Beautification - Plans and Studies -
Mayor Charles W. Burkett [*Downtown Vision Advisory Committee to discuss*]**
- S. Sidewalk on N 95th St between Abbott and Byron - Mayor Charles W. Burkett**
- T. Beach Raking – Mayor Charles W. Burkett**
- U. Community Digital Signs – Mayor Charles W. Burkett**
- V. Government Academy - Mayor Charles W. Burkett**
- W. Various Tourism Related Events, Initiatives, and Destination Marketing - Mayor Charles W. Burkett**
- X. Classification and Compensation Study – Mayor Charles W. Burkett**
- Y. Flooding/Drainage Improvements – Guillermo Olmedillo,
Town Manager**
- Z. Abbott Avenue Drainage Improvements – Commissioner Nelly Velasquez**

AA. Downtown Surfside Sidewalk Beautification - Plans and Studies -
Mayor Charles W. Burkett – *Referred to DVAC*

10. Adjournment

A motion was made by Commissioner Kesl to adjourn the meeting without objection at 11:04 p.m. The motion received a second from Commissioner Salzhauer. All voted in favor.

Accepted this ____ day of _____, 2020.

Charles W. Burkett, Mayor

Attest:

Sandra N. McCready, MMC
Town Clerk



**Town of Surfside
Town Commission Budget Workshop
MINUTES
June 18, 2020
7:00 p.m.**

Town Hall Commission Chambers - 9293 Harding Ave, 2nd Floor
Surfside, FL 33154

1. Opening

A. Call to Order

Mayor Burkett called the meeting to order at 7:07 p.m.

B. Roll Call of Members

Town Clerk McCready called the roll with the following members present:

Present: Mayor Charles Burkett, Vice Mayor Tina Paul, Commissioner Nelly Velasquez, Commissioner Eliana Salzhauer and Commissioner Charles Kesl (arrived at 7:08 pm)

Also present were Town Manager Guillermo Olmedillo and Town Attorney Lillian Arango.

2. FY 2021 Commission Direction Budget Workshop, Discussion and Direction for the FY 2021 Budget– Guillermo Olmedillo, Town Manager

Town Manager Guillermo Olmedillo introduced the item and advised the Commission that on July 1, 2020 the Town will receive the final taxable information. He introduced Interim Assistant Town Manager/Finance Director Jason Greene to make the presentation.

Interim Assistant Town Manager/Finance Director Greene gave the presentation. He spoke about the goals, outcomes and program modifications for the FY 2021 budget. He advised there is no action to be taken tonight. This is purely informational and will be rolled into the preliminary budget. He stated that this budget will be further discussed at the July workshop where the Commission will set the maximum millage rate at that time. He advised the Commission on the timetable regarding setting and adjusting the milage rate.

Interim Assistant Town Manager/Finance Director spoke regarding requests made by the Town Commission at the previous budget. He shared the property values and millage summary report that reflected a negative taxable value for the Town.

Commissioner Velasquez asked regarding the decrease in taxable value if it was on single family homes or the new construction in Town and if the residents will receive a lower tax bill.

Interim Assistant Town Manager/Finance Director Greene answered Commissioner Velasquez' question and stated it is on all taxable properties in the Town. He also stated that there will be a decrease in the property values town-wide if the market value remains the same as the assessed value. He stated if that occurs then the resident would pay less in property taxes.

Commissioner Salzhauer stated that her understanding was that there would be a change in the commercial properties.

Interim Assistant Town Manager/Finance Director Greene stated that this is unique due to COVID-19 and one will not see the change for a couple of years.

Commissioner Velasquez asked who would determine when the Town would see the changes.

Interim Assistant Town Manager/Finance Director Greene answered Commissioner Velasquez' question and stated it is up to the Property Appraiser to make those changes.

Mayor Burkett addressed the questions from the Commissioners and explained what the possible impact would be next year.

Commissioner Kesl asked if the one part of the budget they would be more impacted in would be the tourism-based tax revenues.

Interim Assistant Town Manager/Finance Director Greene answered Commissioner Kesl's question and stated they are still modeling out the resort tax and believes that the Town would still be in good shape in that area.

Commissioner Salzhauer stated that residents are concerned that there will be a reduction in quality of service. She stated that the residents need to know how much is coming in and to make sure they do not have to cut services. She asked when the Town would have more concrete numbers in the tourist tax.

Mayor Burkett asked how often they collect revenue from the hotels. He has seen a decrease in collection therefore, one assumes the decrease would continue.

Interim Assistant Town Manager/Finance Director Greene answered the Commission's and the Mayor's comments on the tourist tax dollars being collected and any reduction.

Further discussion took place among the Town Commission and Interim Assistant Town Manager/Finance Director Greene regarding the monies coming in from tourist tax dollars and if money is needed to make up for that decrease. He stated that the Town needs to be prepared in order to maintain the same level of service and quality of life as well as giving tax relief to the residents by reducing the millage rate.

Interim Assistant Town Manager/Finance Director Greene continued the summary of the program modifications and spoke regarding the procurement specialist and what their duties would be.

Commissioner Salzhauer spoke regarding the duties of a procurement specialist whose job is to save the Town money and look to hire a specialist.

Commissioner Velasquez stated that the Town should look into current staff and not hire new staff but rather train a staff member to do the duties of a procurement specialist.

Commissioner Salzhauer stated that this an area of specialty and is a specific area and it needs to be someone properly trained in that area. She also stated to see if there is an overlap in some staff and put the right people in place.

Vice Mayor Paul would like to see the position be sustainable and one needs to lead by example.

Further discussion took place among the Town Commission and Staff regarding the procurement specialist position, the duties of that position, and will it be a full-time position as well as possibly using current staff.

Interim Assistant Town Manager/Finance Director Greene discussed each program modification in detail.

Commissioner Kesl stated that he requested a detailed report regarding cyber security and spoke regarding that issue.

Commissioner Salzhauer spoke regarding repairs and funding needed to make the repairs in order to have the Community Center open and operating.

Mayor Burkett asked if there is a reason why all the work cannot be done at once and asked Town Manager Olmedillo and Interim Assistant Town Manager/Finance Director Greene to coordinate the repairs and work to be done at once.

Interim Assistant Town Manager/Finance Director Greene continued with the police purchase of additional firearms.

Commissioner Velasquez asked why is there a need to purchase additional firearms.

Police Chief Yero stated that the firearms the officers are currently using are over seven years old and invited Lieutenant Marciante to explain the budget item.

Lieutenant Marciante explained the need to purchase new firearms and explained the life span of a firearm. He further explained the cost to rebuild firearms and what other departments are currently doing, which is turning in old firearms, and they get anywhere between a \$200-\$250 credit.

Commissioner Kesl asked if this was originally budgeted for.

Interim Assistant Town Manager/Finance Director Greene stated this is a request for the upcoming FY 2021 budget.

Lieutenant Marciante addressed Commissioner Kesl's question and reiterated the fact that 20% of their firearms went down and the cost to repair those.

Further discussion took place among the Commission and staff regarding the cost of the firearms and the credit given to the Town.

Interim Assistant Town Manager/Finance Director Greene continued with the budget presentation and addressed questions asked by the Town Commission regarding the capital improvement project and capital outlay for police vehicles.

Commissioner Kesl commented on the take home vehicles and that is probably where a lot of the miles come from. He asked what is the history of the take home vehicles, which ages the vehicles prematurely.

Town Manager Olmedillo addressed the comment made by Commissioner Kesl regarding the take home vehicles which some department directors have as part of their employment package. He spoke regarding the take home police vehicles and the benefits of the officers having those take-home vehicles.

Police Chief Yero expanded and explained the take home vehicles for police officers which took place over two decades ago. It is part of the Bargaining Agreement which officers agreed to take less pay in order to have the take home vehicles. He also discussed if the police officers do not have take home vehicles, it would take approximately 30 minutes for the police officers to transfer all of their equipment from their personal vehicles to the police vehicle. He stated that is 30 minutes the police officers are not patrolling the Town.

Commissioner Salzhauer stated that she does understand that take home vehicles for police officers is a union negotiation and we do want the police

officers to be happy. She stated that she believes that they should discuss the take home vehicles for non-police officers.

Vice Mayor Paul stated that she understands the Public Works Director and Building Official need take home vehicle which allows them to be on call to address Town emergencies.

Further discussion took place among the Town Commission and staff regarding take home vehicles and car allowance.

Commissioner Salzhauer requested more detailed information on the take home vehicles and car allowance for Town employees for the next meeting.

Interim Assistant Town Manager/Finance Director Greene addressed the comments made and stated that most department heads have a car allowance and there are only a few that have actual take home vehicles.

Mayor Burkett stated that what the Commission needs to look at is the employment package when hiring. He requested to bring back a budget that cuts 10% and get the fat out. He would like to see those numbers and get a comprehensive report from Interim Assistant Town Manager/Finance Director Greene.

Interim Assistant Town Manager/Finance Director Greene presented the budget item for the utility vehicle for the Police Department that is used for the beach. It is beyond its life span and it can be covered under savings on the capital outlay from the police department.

Commissioner Salzhauer asked if that vehicle could be electric.

Vice Mayor Paul stated that she never smells gasoline from the beach vehicles and it would be good to move towards the direction of an electric vehicle.

Interim Assistant Town Manager/Finance Director Greene presented slides of the interest the Commission has tackling litter town-wide as a Litter Management Program.

Vice Mayor Paul stated that she would like to have a decision made with the street sweeper and would like to agree to bring the program back even if it is modified, especially during hurricane season.

Mayor Burkett asked if anyone is against resuming the street sweepers.

Commissioner Salzhauer stated that she does not mind restarting the street sweeper program and suggested possibly doing it every other week. She spoke regarding coverage every day on the beach and possibly getting the monies from Tourism dollars as well as having regular maintenance done.

Commissioner Velasquez believes the street sweeping should be done weekly and choose a specific day of the week, possibly Wednesday, that way the residents will know when to move their vehicles.

Commissioner Kesl stated that issues have been identified and suggested for the Town to come up with a comprehensive plan and the one metric missing is a comparable parking plan to put in place.

Commissioner Salzhauer stated that the funds come out of the water and sewer fund and at the same time the Commission wants to reduce the cost of the water bill for the residents.

Further discussion took place among the Town Commission and staff regarding the street sweeper, having it done on a weekly basis and the cost involved.

Mayor Burkett commented on the Big Belly and that is a new idea which the past Commission put in place and the cost involved. He agrees to start the street sweeper and they are missing areas and not properly cleaning. He would like to see Interim Assistant Town Manager/Finance Director Greene, Town Manager Olmedillo and staff possibly bringing the street sweeper inhouse and is happy they are getting rid of the Big Belly.

Further discussion took place among the Commission regarding the street sweeper, its schedule and the plan provided with benchmarks and goals by Interim Town Manager/Finance Director Greene.

Interim Assistant Town Manager/Finance Director Greene spoke regarding items that were removed and gave an overview of the staffing adjustment the Commission requested.

Commissioner Velasquez commented on placing Code Compliance under the Building Department. She commented on why they are having three different individuals handling the website including Pinzur and is not in agreement with that change.

Commissioner Salzhauer commented on Code Compliance and having an assistant director in a small department, and would like clarification as to why they are not in the field all the time. She stated that the beach chair ordinance will require code enforcement issues. She agrees with Code Compliance going under the Police Department and wants to make sure they have the right personnel in place. She spoke regarding streamlining the organization and staffing.

Commissioner Kesl would like a quality assurance component with public relations, measurable results and a matrix showing how effective the new plan will be once implemented.

Commissioner Velasquez asked regarding violations in Town and other items taking place during the year, are they still giving out violations and if the person is only working on beach compliance.

Town Manager Olmedillo addressed the comments made by the Town Commission and gave a synopsis of the process of Code Compliance.

Further discussion took place among the Town Commission and Town Manager Olmedillo regarding the Code Compliance change of position titles and the other changes in staffing.

Commissioner Salzhauer commented on changes needing to be made in the Building Department, which includes the department files to be digitized going forward, having an auditor in the Building Department as well as the Assistant Town Manager's position.

Mayor Burkett addressed the comments made by Commissioner Salzhauer regarding the Building Department.

Vice Mayor Paul commented on digitizing the Building Department.

Commissioner Velasquez commented on the resiliency officer position and does not feel that it should be another communications position.

Mayor Burkett stated that it is good that the Town has some extra funds in order to be able to get this done.

Further discussion took place regarding the difference between a grant writer and a lobbyist.

Vice Mayor Paul explained the difference between a grant writer and a lobbyist.

Mayor Burkett asked how many more workshops the Commission needs to have.

Interim Assistant Town Manager/Finance Director Greene stated that there are three more workshops and gave the different timelines for those workshops.

Mayor Burkett asked Interim Assistant Town Manager/Finance Director Greene to see how this COVID downturn will affect us and will it affect the \$2 million cushion. He also stated that will determine how it will affect his decision on the millage rate.

Commissioner Salzhauer thanked Public Works Director Stokes for his hard work.

The Town Commission made their individual closing remarks.

3. Adjournment

There being no further business to discuss, the meeting adjourned without objection at 10:00 p.m.

Accepted this ____ day of _____, 2020.

Charles W. Burkett, Mayor

Attest:

Sandra N. McCready, MMC
Town Clerk



**Town of Surfside
Special Town Commission Meeting
MINUTES
June 23, 2020
7 p.m.**

Town Hall Commission Chambers - 9293 Harding Ave, 2nd Floor
Surfside, FL 33154

1. Opening

A. Call to Order

Mayor Burkett called the meeting to order at 7:07 p.m.

B. Roll Call of Members

Town Clerk McCready called the roll with the following members present:

Present: Mayor Charles Burkett, Vice Mayor Tina Paul, Commissioner Nelly Velasquez, and Commissioner Eliana Salzhauer.

Absent: Commissioner Charles Kesl.

Also present were Town Manager Guillermo Olmedillo and Town Attorney Lillian Arango.

C. Mayor and Commission Remarks

Commissioner Velasquez stated that before addressing the Resolutions she would like to address concerns from the residents and move item 4GG up on the agenda. Consensus was reached to hear Item 4GG after item 4.

Commissioner Salzhauer requested to move item 4A update to be heard before the resolutions, seconded by Vice Mayor Paul. Commissioner Velasquez and Mayor Burkett voted no. Commissioner Salzhauer and Vice Mayor Paul voted yes. Commissioner Kesl was absent. The motion failed.

Town Manager Guillermo Olmedillo would like to have item 4CCC and Item 4Z to be heard at the pension workshop which would possibly simplify matters and not have it heard tonight

A motion was made by Commissioner Velasquez to move item 4CCC up on the agenda to be heard after the Resolutions, seconded by Vice Mayor Paul. All voted in favor with Commissioner Kesl absent.

Commissioner Velasquez made a motion to move item 4GG, seconded by Mayor Burkett. All voted in favor with Commissioner Salzhauer voting no and

Commissioner Kesl absent.

Commissioner Salzhauer stated that they should have a Town Hall meeting or workshop to have residents involved regarding the issues with items 2E and 2F which impact the Town of Surfside.

Mayor Burkett addressed the comments made by Commissioner Salzhauer and believes this is critical and needs to be addressed. He also stated that he has no problem placing this item to be heard at a workshop.

Commissioner Salzhauer stated that she does not want a debate and these resolutions need to be removed as a whole. She stated that she believes this is not the forum to have these discussions and is more interested in healing and taking care of Town issues.

Mayor Burkett asked Town Clerk McCreedy to have these items placed on an agenda for a workshop and to coordinate dates and times with the elected officials and staff to schedule this workshop.

Commissioner Velasquez stated that item 4GGG has been on the agenda for a while and the residents need to have this item addressed. She requested for this item to be placed on the November 2020 election ballot.

Vice Mayor Paul stated that the item on undergrounding power lines has been on the agenda for a while and there are many items on this agenda that need to be addressed.

Mayor Burkett stated that the order of the agenda is the order unless there is a consensus of having items moved up to be heard earlier.

Commissioner Salzhauer stated why is the Mayor having items 2E and 2F heard at the workshop meeting.

Mayor Burkett addressed the comments made by Commissioner Salzhauer and stated that items 2E and 2F will be placed on the agenda for the workshop.

1. Essential Business & Focus – Commissioner Charles Kesl

Item was not heard due to Commissioner Kesl being absent at this meeting.

2. Direction and Action on motion to Censure Commissioner Salzhauer – Commissioner Charles Kesl

Item was not heard due to Commissioner Kesl being absent at this meeting.

2. Resolutions

A. Audio Visual Equipment Upgrades and Extended Maintenance & Support – Guillermo Olmedillo, Town Manager

A RESOLUTION OF THE TOWN COMMISSION OF THE TOWN OF SURFSIDE, FLORIDA, APPROVING THE PROPOSALS FOR AUDIO VISUAL AND BROADCASTING EQUIPMENT AND SUPPORT, ZOOM ROOM INTEGRATION, CLOSE CAPTIONING EQUIPMENT AND MAINTENANCE, AND ADDENDUM (COLLECTIVELY, AGREEMENT) WITH AUDIO VISUAL INNOVATIONS, INC.; PROVIDING FOR AUTHORIZATION AND IMPLEMENTATION OF THE AGREEMENT; AUTHORIZING EXPENDITURE OF FUNDS; AND PROVIDING FOR AN EFFECTIVE DATE.

Town Clerk McCready read the title of the resolution into the record.

Town Manager Guillermo Olmedillo introduced the item and stated there are two legs of this item and explained what the two platforms are.

Vice Mayor Paul commented on the zoom integration and audio-visual portion of this item. She stated that this was done previously and how much of this is new besides the zoom integration. She also commented on the similar upgrades done in the past.

Mayor Burkett asked if the television broadcasting is tied to the audio-visual portion.

Vice Mayor Paul commented on the price of this request.

Eric Wells, CGA, gave an explanation of the item and the testing that has been done with different systems.

Further discussion took place on the type of system, what it would provide and how this program would work. The Commission asked if this is a legal obligation and if there is a system that is less expensive.

Town Attorney Arango stated that through ADA compliance, the municipalities are mandated to have ADA as an accommodation.

Mayor Burkett stated that he suggests to go back out and see if there are other options that are more cost effective.

Vice Mayor Paul stated she was not in support of the zoom integration portion and if there are other options.

Commissioner Velasquez stated that she would like to know why is zoom being brought into the chambers when people can see the meeting through the television channel and does not see the point in that.

Mayor Burkett addressed the comment made by Commissioner Velasquez. It was to have the residents speak from their home without them having to come in person to the chambers.

Commissioner Salzhauer agreed and she has concerns with the zoom format and the disrespectfulness that is occurring on zoom now.

A motion was made by Vice Mayor Paul to have IT to come back with more options and obtain other bids, seconded by Commissioner Salzhauer. All voted in favor with Commissioner Kesl absent.

B. Sand Dollar Key Tot Lot and Waterslide Renovations – Guillermo Olmedillo, Town Manager

A RESOLUTION OF THE TOWN COMMISSION OF THE TOWN OF SURFSIDE, FLORIDA, APPROVING THE PURCHASE OF WATERSLIDE REPAIR AND MAINTENANCE WORK FROM DALE COOPER LLC D/B/A SAFE SLIDES RESTORATION; FINDING THAT THE PURCHASE IS EXEMPT FROM COMPETITIVE BIDDING PURSUANT TO SECTION 3-13(7)F OF THE TOWN CODE AS A PUBLIC WORKS OR UTILITIES PURCHASE FOR TOWN FACILITY MAINTENANCE WORK; AUTHORIZING THE TOWN MANAGER TO ENTER INTO A PURCHASE ORDER FOR SUCH PURCHASE; PROVIDING FOR IMPLEMENTATION; AND PROVIDING FOR AN EFFECTIVE DATE.

Town Clerk McCready read the title of the resolution into the record.

No discussion took place among the Commission on this item.

A motion was made by Vice Mayor Paul to approve the Resolution, seconded by Commissioner Velasquez. All voted in favor with Commissioner Kesl absent.

C. Youth Sports Program Coaches (Cyclone Soccer) - Guillermo Olmedillo, Town Manager

TOWN OF SURFSIDE, FLORIDA, APPROVING AGREEMENTS WITH CYCLONE SOCCER MIAMI, INC. FOR THE TOWN'S YOUTH INSTRUCTIONAL SOCCER AND COMPETITIVE SOCCER PROGRAMS; FINDING THAT THE SERVICES ARE EXEMPT FROM COMPETITIVE PROCUREMENT PURSUANT TO SECTION 3-13(2) OF THE TOWN CODE; PROVIDING FOR IMPLEMENTATION; AND PROVIDING FOR AN EFFECTIVE DATE.

Town Clerk McCready read the title of the resolution into the record.

Commissioner Velasquez asked why is there no competitive bidding on this item.

Parks Director Milian introduced the item and stated that the previous item was exempt from competitive bidding due to the change in the procurement process. He stated that this company has been doing business with the Town since 2006 and it has been a very successful program as well as it being recommended by the Parks and Recreation Committee.

Commissioner Salzhauer stated that it is a great program.

A motion was made by Commissioner Salzhauer to approve the Resolution, seconded by Commissioner Velasquez. All voted in favor with Commissioner Kesl absent.

D. Town's Zoning Code Review and Support - Guillermo Olmedillo, Town Manager

A RESOLUTION OF THE TOWN COMMISSION OF THE TOWN OF SURFSIDE, FLORIDA, APPROVING THE ENGAGEMENT OF CWB ASSOCIATES (C. WESLEY BLACKMAN, AICP) FOR PLANNING CONSULTING SERVICES FOR SUPPORT IN THE REVIEW OF THE TOWN'S ZONING CODE; FINDING THAT THE SERVICES ARE EXEMPT FROM COMPETITIVE PROCUREMENT PURSUANT TO SECTION 3-13(2) OF THE TOWN CODE; AUTHORIZING THE TOWN MANAGER TO EXECUTE A PROFESSIONAL SERVICES AGREEMENT FOR THE SERVICES; PROVIDING FOR IMPLEMENTATION; AND PROVIDING FOR AN EFFECTIVE DATE.

Town Clerk McCready read the title of the resolution into the record.

Town Manager Olmedillo introduced the item. He explained that the conversation through workshops and Commission meetings was to work on the zoning code and have someone from the outside do the analysis in order to incorporate those suggestions. He stated that Mr. Blackman participated in the workshop and he offered his services. He stated that having an independent zoning expert would be of great assistance.

Commissioner Salzhauer stated there should be a specific question regarding how they can take the current code and how it could currently work for the Town. She does not find it productive to hire someone and suggested to wait until they have the Planning and Zoning Board in place before using Mr. Blackman's services.

Commissioner Velasquez asked when the Commission would be picking the committee members, especially the Planning and Zoning Board since there are residents waiting on getting their work done.

The following members from the public spoke on the item:

Jeff Rose spoke regarding the Planning and Zoning Board and the need to have this Board in place.

Yoann Andreu spoke regarding the Planning and Zoning Board and when that Board would be in place.

George Kousoulas spoke regarding having the Planning and Zoning Board in place.

Vice Mayor Paul addressed the comments made by the residents and the need to have the Planning and Zoning Board in place.

Commissioner Salzhauer commented on having the board appointments made at the Zoning Workshop on July 1, 2020.

Commissioner Velasquez stated that she would like to hear what Mr. Blackman comes up with regarding the zoning code and would like to appoint the members of the Planning and Zoning Board tonight.

Mayor Burkett addressed the comments made by the public and the Commission regarding the appointments for the Planning and Zoning Board as well as the new zoning code versus the old zoning code.

Commissioner Salzhauer addressed comments made by Mayor Burkett and stated that there is no need to identify what the residents do for a living. She stated that they are individuals that are trying to do what they need to do for their families and finish their homes. She believes this is putting a wrench into things by delaying and complicating the issue which delays the residents from finishing their projects.

Vice Mayor Paul stated that she agrees with Commissioner Salzhauer and it is important to hire a planner. She stated that it is not appropriate to do this right now. She would like to address item 4AAA and have the public see what the problems are with the different zoning codes. She also stated that they have very good people on the Planning and Zoning Board and that Mayor Burkett misspoke when he stated that the current Planning and Zoning Board were the ones that got the Town in this place.

Commissioner Velasquez stated that she would like to vote on this item and give Mr. Blackman a specific date to start.

Mayor Burkett addressed the comments made by the Commission regarding the change in the zoning code and who was responsible for those changes.

Further discussion took place among the Commission regarding the history of the zoning code.

Mayor Burkett clarified the comments made regarding the previous zoning code and the “Dietch” zoning code.

Vice Mayor Paul addressed the comments made by Mayor Burkett and clarified what took place and the votes that the previous commission made.

A motion was made by Commissioner Salzhauer to defer the item, seconded by Vice Mayor Paul. The motion failed with Commissioner Velasquez and Mayor Burkett voting against and Commissioner Kesl absent.

A motion was made by Commissioner Salzhauer to defer the item and make the appointments for the Planning and Zoning Board at the July 1, 2020 meeting, seconded by Vice Mayor Paul. All voted in favor with Commissioner Kesl absent.

E. Black Lives Matter – Mayor Charles W. Burkett

A RESOLUTION OF THE MAYOR AND TOWN COMMISSION OF THE TOWN OF SURFSIDE, FLORIDA, CONDEMNING THE ALLEDGED CRIMINAL ACTIONS OF THE MINNEAPOLIC POLICE OFFICERS INVOLVED IN THE DEATH OF GEORGE FLOYD, EXTENDING CONDOLENCES TO THE FAMILY OF GEORGE FLOYD FOR THEIR LOSS, AND SUPPORTING THE FLOYD FAMILY BY WAY OF A CALL FOR TRUE SOCIAL JUSTICE, RACIAL EQUALITY AND BY WAY OF OTHER INITIATIVES OUTLINED HEREIN; PROVIDING FOR TRANSMITTAL; AND PROVIDING FOR AN EFFECTIVE DATE.

Town Clerk McCready read the title of the resolution into the record.

The Commission reached a consensus to move this item to a future workshop.

F. Black Lives Matter – Commissioner Eliana Salzhauer

A RESOLUTION OF THE MAYOR AND TOWN COMMISSION OF THE TOWN OF SURFSIDE, FLORIDA, IN SUPPORT OF THE BLACK LIVES MATTER MOVEMENT AND THE TOWN OF SURFSIDE’S COMMITMENT TO RACIAL EQUALITY; PROVIDING FOR IMPLEMENTATION; PROVIDING FOR TRANSMITTAL; AND PROVIDING FOR AN EFFECTIVE DATE

Town Clerk McCready read the title of the resolution into the record.

The Commission reached a consensus to move this item to a future workshop.

- 3. Public Comments from Residents (Set for approximately 8:15 p.m.)**
Public comments for subjects or items not on the agenda. Public comment on agenda items will be allowed when agenda item is discussed by the Commission.

The following individuals from the public spoke:

Brian Bey spoke regarding the Black Lives Matter item and if any black residents were advised to attend the meeting. He spoke regarding a discussion he had with Vice Mayor Paul and Commissioner Salzhauer. He conveyed his thoughts and his experience living in Surfside.

Diana Gonzalez spoke regarding the frustration the residents are having and would like for all the Commissioners to have good behavior.

Horace Henderson spoke regarding short-term rentals and the 2011 ordinance. He stated that the association requested from the Town for those owners that have nothing to do with short-term rentals, not have to be pay for the ones that do have short-term rentals. He requested to postpone this rule until the Commission gets to the short-term rental item. He also spoke regarding the zoning code.

Jeff Rose read a statement into the record and possible retaliation from Mayor Burkett and discussed the need for the Planning and Zoning Board.

Shalome Hakmon spoke regarding the zoning code and the comparison of both codes.

Manda Davenport spoke regarding the demand in Town and that is why developers come to Surfside. She spoke about other issues the Town needs to address including the underground powerlines, and other issues that have not even been put on the agenda.

Debbie Cimadevilla spoke regarding all the Commission to respect each other and set an example.

George Kousoulas spoke regarding the undergrounding of powerlines. He stated that the best format would be a workshop due to the complex nature of this topic and the cost involved.

Clara Diaz Leal spoke regarding the direction of the Town and moving forward. She spoke regarding having someone to do something about the traffic and address the importance of other issues which need to addressed.

Deputy Town Clerk Herbello read the email received from resident Eli Tourgeman and Ellen Abramson into the record.

Commissioner Velasquez asked if those two resolutions regarding Black Lives Matter could be addressed at the July 1st meeting to assist the residents.

Commissioner Salzhauer addressed the comments made by Mr. Bey and stated that the discussion was to have a workshop to discuss those two resolutions and to educate the public on what is taking place.

Commissioner Salzhauer addressed the comments made by the public speakers regarding painting the streets with the different options. She stated that everyone is working on all the issues.

Vice Mayor Paul asked Town Attorney Arango regarding the condominium association issue and the comments made by Mr. Hendersen regarding short-term rentals.

Town Attorney Arango responded to Vice Mayor Paul's question regarding the short-term rentals.

Commissioner Velasquez spoke regarding the comments made by the residents and the grants offered for undergrounding powerlines. She stated that she would like to know that it is not only one person but the entire town that wants the undergrounding of the powerlines.

Mayor Burkett addressed comments made by the public speakers and the Commission. He stated that it is important to get the undergrounding of the powerlines on the ballot.

4. Mayor, Commission and Staff Communications

A. COVID-19 Task Force Update – Mayor, Vice Mayor and Members of the Town Commission

Commissioner Salzhauer would like to address making wearing masks in all public space mandatory.

Sustainability and Resiliency Officer Stein gave an update on the COVID-19 Task Force. She spoke regarding other municipalities' mandate of wearing masks. She also stated businesses are closing due to the COVID-19 issue and how they could assist the businesses. She spoke regarding the possibility of cancelling the July 4th fireworks event and the concern from the Police Department as to how to enforce social distancing.

Mayor Burkett shared a graph of the increase in cases that may be related to the protests and testing that are being done. He stated that the number of deaths has gone down and although the numbers have gone up, we do not need to panic.

Vice Mayor Paul commented that the increase in cases was due to individuals going back to work and more testing taking place. She does believe that they should reconsider the July 4th fireworks since we are the only ones having it which would become a problem because we would be inviting bigger crowds.

Commissioner Salzhauer asked if hospitalization numbers have gone up.

Sustainability and Resiliency Officer Stein stated that the increase is not only because of the increase in testing.

Commissioner Salzhauer commented on the rise in cases and is concerned of the Town shutting down again. She stated that she would like to know if there has been any moving forward with wearing masks, social distancing and following the County lead.

Commissioner Velasquez asked Sustainability and Resiliency Officer Stein where she found the information that hospitalization had gone up.

Sustainability and Resiliency Officer Stein answered Commissioner Velasquez' question.

Commissioner Velasquez stated that she does not agree in cancelling the fireworks and that the individuals attending could wear masks. She stated that it is important due to what this event represents.

Mayor Burkett stated that the numbers of admitted patients have gone up, agrees in being extra cautious and we do not want to add to the problem. He asked if they can they have a fireworks show without attracting others from other areas.

Town Manager Olmedillo stated that no coastal cities are holding fireworks except Surfside. He stated that only four inland cities are having it without allowing any individuals from attending. The beach is closed by 8 pm and then enforcement is the bigger issue once the fireworks start, how do you enforce not having people on the beach and not having enough individuals to enforce.

Town Attorney Arango stated that they might have issues obtaining approval from the County to get a permit for the event.

Parks Director Milian addressed the Commission regarding permitting by Zambelli and their cancellation policy with the cost involved.

Commissioner Velasquez asked if they can have it at the 96th Street Park.

Parks Director Milian stated that 96th Street Park is less than an acre and it borders homes as well as the fact that they do not have the perimeter to fire the fireworks.

Vice Mayor Paul stated that in the past the Town would block sections of the beach and it is very crowded in the area that the fireworks take place and that is when other municipalities have fireworks events taking place.

A motion was made by Commissioner Salzhauer to cancel the July 4th fireworks, seconded by Vice Mayor Paul. All voted in favor with Commissioner Kesl absent and Commissioner Velasquez voting no.

Commissioner Salzhauer asked what the mask requirements are and can we have an emergency order issued. She asked what Bal Harbour and Bay Harbor are currently doing.

Town Attorney Arango answered Commissioner Salzhauer's question that currently there are no required facials masks in public places and that Miami Dade County's Mayor will not be issuing a general order of wearing masks in public places.

Commissioner Salzhauer stated that if the numbers continue to climb, she believes the Town should take stricter measures.

B. Brightview Agreement (FKA Luke's Landscape) Report and Follow up– Staff Report – Guillermo Olmedillo, Town Manager

Town Manager Olmedillo gave an update on the item and the cost for inhouse services.

Vice Mayor Paul gave a history of how Luke's Landscaping came into the picture and the work they have done for the Town. She stated that it is time to reevaluate their contract but would not make a move right now due to hurricane season. She also stated that bringing it inhouse also poses a problem in relation to equipment.

Commissioner Velasquez stated that she does believe they should bring this inhouse.

Mayor Burkett addressed comments made by the Commission and agrees that they should get other prices. He spoke regarding the cost of having our own staff to do the work and would make it easier to direct the staff into areas that need more work done.

A motion was made by Commissioner Salzhauer to put out an RFP for competitive bidding and request Luke's Landscape to renegotiate their existing contract, seconded by Vice Mayor Paul. All voted in favor with Commissioner Kesl absent.

C. Reconsideration of the Installation of Berms on 92nd Street - Vice Mayor Tina Paul

Vice Mayor Paul introduced the item and stated that this was discussed at the May 26, 2020 meeting and she would like to reconsider her vote on that item.

Mayor Burkett advised Vice Mayor Paul that the berm has already been placed in and the work has been completed.

D. Miami Christmas Lights – Guillermo Olmedillo, Town Manager

Town Manager Olmedillo introduced the item.

Mayor Burkett stated that he would like to know if the Commission has suggestions and believes these lights are expensive.

Commissioner Velasquez commented on the cost involved and believes it is an excessive amount of money to spend on lights.

Commissioner Salzhauer stated that they did come back with other options.

Frank Trigueros addressed the comments made by the Town Commission.

Further discussion took place regarding the item and the cost involved.

Direction was given by the Town Commission to bring back more information and the cost regarding this item at the next Commission meeting.

E. Staffing Hiring Freeze – Commissioner Eliana Salzhauer

Commissioner Salzhauer introduced the item. She stated that they need to be careful with COVID in reference to reopening the beaches and not knowing what is coming forward. She stated that she would like for the hiring freeze to still be in place until the new Town Manager is hired.

Town Manager Olmedillo stated that they are running into situations with the Parks Department, Maintenance and Sanitation Department and would like to get authorization to fill those positions due to the amount of work they currently have.

Commissioner Velasquez agrees with the Town Manager. She stated that if they need the staff to sanitize and clean, to allow him to hire the person to satisfy those needs.

Vice Mayor Paul stated that they should hire the custodian and be flexible with the other positions.

F. New Zoning Code- Procedural and Notice Requirements – Mayor Charles W. Burkett

Mayor Burkett stated that they need a new zoning workshop.

Town Clerk McCready stated that they can place the appointments at the beginning of the workshop and then have the zoning code item heard.

Vice Mayor Paul commented on trying to have time off and review the material and not have a meeting each week.

A motion was made by Commissioner Velasquez to have the appointments to the Planning and Zoning Board at 7:00 p.m. as a Special Town Commission Meeting on July 1, 2020, and at 8:00 p.m. a Zoning Code Workshop on July 1,

2020, seconded by Vice Mayor Paul. All voted in favor with Commissioner Salzhauser voting no and Commissioner Kesl absent.

G. 92nd St Beach-end Improvements - Mayor Charles W. Burkett

Item deferred to the next meeting.

H. Rope Fencing & Posts-Beachwalk/Hardpack - Mayor Charles W. Burkett

Item deferred to the next meeting.

I. Develop Capital Improvement Plan (CIP) - Mayor Charles W. Burkett

Item deferred to the next meeting.

J. 10 Year Water Supply Plan - Mayor Charles W. Burkett

Item deferred to the next meeting.

K. Various Parks & Recreation Related Events and Initiatives – Mayor Charles W. Burkett

Item deferred to the next meeting.

L. Building Department File Digitization – Mayor Charles W. Burkett

Item deferred to the next meeting.

M. Pinzur Communication – Mayor Charles W. Burkett

Item deferred to the next meeting.

N. Preservation of Eden Project located at 9300 Collins Avenue - Mayor Charles W. Burkett

Item deferred to the next meeting.

O. Speeding on Collins and Harding - Mayor Charles W. Burkett

Item deferred to the next meeting.

P. Amending Town Code Section 2-205 Conduct of Meetings; Agenda – Mayor Charles W. Burkett

Item deferred to the next meeting.

Q. Homeless Contribution by the Town of Surfside of \$100,000 - Mayor Charles W. Burkett

Item deferred to the next meeting.

R. Free (hassle-free) downtown parking for residents - Mayor Charles W. Burkett

Item deferred to the next meeting.

S. Charter Amendments to affirm the limit of pay for elected officials to a maximum of \$1 per year, term limits for elected officials of 3 consecutive terms, or any part thereof, for both Mayor & Commissioners, a prohibition on the sale or leasing of any Town property without a referendum & a prohibition against any loan or borrowing of any type, which would put the Town into debt for more than 10% of its annual property tax revenue and which could not be fully amortized within a total of 5 years and restore development protections in the charter- Mayor Charles W. Burkett

Item deferred to the next meeting.

T. Records Retention Policy – Mayor Charles W. Burkett

Item deferred to the next meeting.

U. Regulation of Short-Term Rentals – Mayor Charles W. Burkett

Item deferred to the next meeting.

V. Star Cleaning service (Street Sweeping) – Mayor Charles W. Burkett

Item deferred to the next meeting.

W. S.M.A.R.T Goals, Quality Control & Quality Assurance – Commissioner Charles Kesl

Item deferred to the next meeting.

X. Design Review Board Discussion – Staff Report – Guillermo Olmedillo, Town Manager

Item deferred to the next meeting.

Y. Weiss Serota Contract Follow up – Staff Report – Guillermo Olmedillo,
Town Manager

Item deferred to the next meeting.

Z. Town Pension Benefits for Non-Public Safety Employees – Mayor Charles
W. Burkett

Item deferred to the next meeting.

AA. Additional lighting in the residential area – Staff Report – Guillermo
Olmedillo, Town Manager

Item deferred to the next meeting.

BB. Construction Guidelines for Hurricane Season – Commissioner Nelly
Velasquez

Item deferred to the next meeting.

CC. Lowering of Property Taxes and Water Bills – Staff Report – Guillermo
Olmedillo, Town Manager

Item deferred to the next meeting.

DD. CGA Contract Follow Up – Staff Report – Guillermo Olmedillo, Town
Manager

Item deferred to the next meeting.

EE. Discussion Regarding Appointments to Committees and Boards –
Sandra N. McCready, Town Clerk

Item deferred to the next meeting.

FF. Downtown Lighting RFP – Mayor Charles W. Burkett

Item deferred to the next meeting.

GG. Undergrounding power lines – Staff Report – Guillermo Olmedillo, Town
Manager

Commissioner Velasquez introduced the item and spoke regarding the grants from FEMA. She stated that the powerlines that are above ground are more of an issue during hurricane season. She requested to have this item placed on the November ballot and have several workshops for the residents to be involved in, this way they would be able to know what the cost would be.

Commissioner Salzhauer commented on the cost involved for this project and stated that the residents do not need to know that especially how unstable the economy currently is.

Town Clerk McCready confirmed with Town Attorney Arango the dates to submit the question on the ballot being July 31, 2020. She stated that they have to request permission from the Miami-Dade Election's Department to add the question on the ballot and that has not taken place.

Vice Mayor Paul stated that this has been spoken about and what FPL is going to do is not enough to underground the entire Town. She stated that they need to get cost estimates in order to provide that information as part of the ballot question. She stated that the residents need to know the cost involved and not sure if grants will be available.

Mayor Burkett addressed the comments made by the Commission and stated that if the residents actually want this on the ballot, he would like this to move forward.

Vice Mayor Paul stated that the motion is too vague and the residents need to know the cost involved.

Further discussion took place regarding the cost involved for undergrounding the powerlines.

The following individuals from the public spoke on the item:

Eli Tourgeman
Ripka Laskar
Debbie Cimadevilla
Sebastian Portillo
Jesse Vinagre
George Kousoulas
Ben Jacobson
Mandy Davonport
Diana Gonzalez
Clara Diaz Leal
Shlomo Danzinger
Claudia Allouche
Jorge Cortes

Deputy Town Clerk Herbello read the email comment by Anthony Blate into the record.

Commissioner Salzhauer addressed the comments made by the public and stated that they need all the information including the numbers regarding the cost involved before placing this on the ballot.

Vice Mayor Paul spoke regarding a conversation she had with the FPL representative. She requested a better explanation from the Town Manager and is in favor with putting it on the ballot but would like to see the question before it goes on the ballot.

Commissioner Velasquez agrees with Vice Mayor Paul and that the residents do need to know the value of the cost for the undergrounding and placing the correct information on the ballot.

Town Attorney Arango stated that there needs to be a resolution passed to add the question on the ballot and that resolution needs to be passed before July 31, 2020.

Mayor Burkett addressed the comments made by the public and stated that they cannot move forward without it being placed on the ballot.

A motion was made by Commissioner Velasquez to add the item on the November 2020 ballot, give direction to the Town Clerk to request permission from the Miami-Dade County Supervisor of Elections and bring back a Resolution with the ballot proposed language at the July 14, 2020 Regular Commission Meeting for approval, seconded by Mayor Burkett. Commissioner Velasquez, Vice Mayor Paul and Mayor Burkett voting in favor with Commissioner Salzhauer voting no and Commissioner Kesl absent.

HH. Dog Park – Mayor Charles W. Burkett

Item deferred to the next meeting.

II. FPL Solar Together - Vice Mayor Tina Paul

Item deferred to the next meeting.

JJ. Climate Environmental Collective - Revised - Vice Mayor Tina Paul

Item deferred to the next meeting.

KK. Interest Free Loans to Surfside Builders Granted by Former Mayor and Commission – Mayor Charles W. Burkett

Item deferred to the next meeting.

LL. How our Zoning Protections Against Over-Development Were Gutted - Mayor Charles W. Burkett

Item deferred to the next meeting.

MM. Amending Town Code Section 2-233 to Include Non-for-Profit – Mayor Charles W. Burkett

Item deferred to the next meeting.

NN. Amending Town Code Section 2-237 Business Relationships – Commissioner Eliana Salzhauer

Item deferred to the next meeting.

OO. Speeding & Stop Sign Running - Commissioner Eliana Salzhauer

Item deferred to the next meeting.

PP. Surfside Point Lake Subaqueous WM Crossing - Bid Documents – Guillermo Olmedillo, Town Manager

Item deferred to the next meeting.

QQ. Beachwalk Trimming- Staff Report – Guillermo Olmedillo, Town Manager

Item deferred to the next meeting.

RR. Pool Deck Lighting for Extended Winter Hours- Staff Report – Guillermo Olmedillo, Town Manager

Item deferred to the next meeting.

SS. Community Center Second Floor – Staff Report - Guillermo Olmedillo, Town Manager

Item deferred to the next meeting.

TT. Streamline Town Staffing – Commissioner Eliana Salzhauer

Item deferred to the next meeting.

UU. Repeal of Ordinance No. 17-1662 Beach Furniture – Mayor Charles W. Burkett

Item deferred to the next meeting.

VV. Replace Ordinance No. 17-1662 Beach Furniture with New Beach Furniture Ordinance – Commissioner Eliana Salzhauer

Item deferred to the next meeting.

WW. Designated (Painted) Walking Areas in the Residential District- Staff Report – Guillermo Olmedillo, Town Manager

Item deferred to the next meeting.

XX. Procurement Expertise – Commissioner Eliana Salzhauer

Item deferred to the next meeting.

YY. Take Home Vehicles - Commissioner Eliana Salzhauer

Item deferred to the next meeting.

ZZ. Recent and Significant Increase in Boat, Paddleboard and Kayak Use on Point Lake – Mayor Charles W. Burkett

Item deferred to the next meeting.

AAA. Comparison of 2006 Code to 2020 Code – Staff Report – Guillermo Olmedillo, Town Manager

Item deferred to the next meeting.

BBB. Stormwater Masterplan - Staff Report – Guillermo Olmedillo, Town Manager

Item deferred to the next meeting.

CCC. Big Belly Trash Contract Termination Replacement and Replacement Bins for Trash and Recycling Receptacles Throughout Town - Guillermo Olmedillo, Town Manager

Town Manager Olmedillo introduced the item and asked Interim Assistant Town Manager/ Finance Director Greene to present the item.

Interim Assistant Town Manager/ Finance Director Greene presented the item and what they need is Commission consensus to remove Big Belly from the current budget and gave an explanation of the item and its options.

Mayor Burkett stated that we need a motion to de-appropriate the item.

Commissioner Salzhauer asked when they are picking a new garbage can.

Interim Assistant Town Manager/Finance Director Greene answered Commissioner Salzhauer's question. They need to choose one by October 1, 2020.

Further discussion took place regarding the item, any fees involved and placing the item to choose the trash cans on the next meeting which is July 14, 2020.

Consensus was reached by the Commission on placing the item to choose the trash cans on the July 14, 2020 Commission Meeting agenda.

A motion was made by Commissioner Velasquez to de-appropriate the item from the budget, seconded by Vice Mayor Paul. All voted in favor with Commissioner Kesl absent.

DDD. Beach Preservation Initiatives ("Carry On-Carry Off"/ Clean-Ups/ Chair- Free Safe Space Behind Community Center) - Staff Report – Guillermo Olmedillo, Town Manager

Item deferred to the next meeting.

EEE. Securing Power Infrastructure: Timely Action Plan for Hurricane Season through accountability now by FPL, ATT and Atlantic Broadband – Staff Report – Guillermo Olmedillo, Town Manager

Item deferred to the next meeting.

FFF.. Amendment to the Tourist Board Ordinance – Commissioner Nelly Velasquez

Item deferred to the next meeting.

Thirty (30) Day Staff Report – Items from March 24, 2020 Special Town Commission Meetings – COMPLETED

Thirty (30) Day Staff Report – Items from March 31, 2020 Special Town Commission Meetings – COMPLETED

Thirty (30) Day Staff Report – Items from April 7, 2020 Special Town Commission Meetings – COMPLETED

Thirty (30) Day Staff Report – Items from April 16, 2020 Regular Town Commission Meetings – COMPLETED

Thirty (30) Day Staff Report – Items from April 21, 2020 Regular Town Commission Meetings - COMPLETED

Thirty (30) Day Staff Report – Items from April 28, 2020 Regular Town Commission Meetings – COMPLETED

Items Completed or Removed from Previous Agendas

- A. Resolution Adopting an Amended Resiliency Reserve Policy Revision**
- B. Resolution Approving the March 17, 2020 Town of Surfside Municipal Election**
- C. Resolution Abolishing the Sustainability and Resiliency Committee**
- D. Resolution Amending the Downtown Vision Advisory Committee**
- E. Resolution Reauthorizing the Parks and Recreation Committee**
- F. “Flash Your Lights” - Commissioner Eliana Salzhauer**
- G. Mandatory Face Mask in the Town of Surfside – Commissioner Nelly Velasquez**
- H. Bandanas for Town Residents – Commissioner Eliana Salzhauer**
- I. Commission Meeting Starting Time at 6:00pm – Mayor Charles W. Burkett**
- J. Discussion Regarding Assistant Town Manager position and Action - Commissioner Nelly Velasquez**
- K. Photovoltaic RFP - Mayor Charles W. Burkett**
- L. Facilities Review - Mayor Charles W. Burkett**
- M. Kayak Launch - Mayor Charles W. Burkett**
- N. Jacober Contract – Mayor Charles W. Burkett**
- O. Zambelli Fireworks Manufacturing - Mayor Charles W. Burkett**
- P. Small Business Survival Grant - Vice Mayor Tina Paul**
- Q. Review of Amendment No. 2 to Update No. 5 Town of Surfside Emergency Measures – Vice Mayor Tina Paul**
- R. Downtown Surfside Sidewalk Beautification - Plans and Studies - Mayor Charles W. Burkett [*Downtown Vision Advisory Committee to discuss*]**
- S. Sidewalk on N 95th St between Abbott and Byron - Mayor Charles W. Burkett**
- T. Beach Raking – Mayor Charles W. Burkett**
- U. Community Digital Signs – Mayor Charles W. Burkett**
- V. Government Academy - Mayor Charles W. Burkett**
- W. Various Tourism Related Events, Initiatives, and Destination Marketing - Mayor Charles W. Burkett**
- X. Classification and Compensation Study – Mayor Charles W. Burkett**
- Y. Flooding/Drainage Improvements – Guillermo Olmedillo, Town Manager**

- Z. Abbott Avenue Drainage Improvements** – Commissioner Nelly Velasquez
- AA. Downtown Surfside Sidewalk Beautification - Plans and Studies -**
Mayor Charles W. Burkett – *Referred to DVAC*
- BB. Police Body-Worn Camera System** – Commissioner Nelly Velasquez
- CC. Care ACT Fund** – Guillermo Olmedillo, Town Manager
- DD. FY 2020 Budget Amendment** – Guillermo Olmedillo, Town Manager
- EE. Purchase of Additional Sewer Pump** – Guillermo Olmedillo, Town Manager
- FF. Planning and Zoning Board Membership Requirements Ordinance**
– Guillermo Olmedillo, Town Manager
- GG. Tourist Board Membership Requirement Ordinances**– Guillermo Olmedillo, Town Manager
- HH. Resolution Renaming the Town’s Higher Education Scholarships to be called the “Arya Gray Memorial Higher Education Scholarship”** – Commissioner Eliana Salzhauer
- II. Interlocal Shuttle System Report Update** – Guillermo Olmedillo, Town Manager

5. Adjournment

A motion was made by Commissioner Velasquez to adjourn the meeting without objection at 11:06 p.m. The motion received a second from Vice Mayor Paul. All voted in favor with Commissioner Kesl absent.

Accepted this _____ day of _____, 2020.

Charles W. Burkett, Mayor

Attest:

Sandra N. McCready, MMC
Town Clerk



**Town of Surfside
Special Town Commission Meeting
MINUTES
July 1, 2020
7 p.m.**

Town Hall Commission Chambers - 9293 Harding Ave, 2nd Floor
Surfside, FL 33154

1. Opening

A. Call to Order

Mayor Burkett called the meeting to order at 7:01 p.m.

B. Roll Call of Members

Town Clerk McCready called the roll with the following members present:

Present: Mayor Charles Burkett, Vice Mayor Tina Paul, Commissioner Nelly Velasquez, Commissioner Eliana Salzhauer and Commissioner Charles Kesl.

Also present were Town Manager Guillermo Olmedillo and Town Attorney Lillian Arango.

C. Mayor and Commission Remarks

Commissioner Kesl stated the reason he was not present at the last Commission Meeting and was pleased with the results from the last meeting.

Discussion among the Commission took place regarding the appointments and criteria that need to be met.

Commissioner Kesl stated that the idea is to interview and determine their availability and which boards they would like to be part of.

Vice Mayor Paul thanked all the applicants and stated that her process was to appoint each member and go Board by Board. She stated that on the Planning and Zoning Board there are two at large members to be appointed.

2. Board and Committee Appointments – Sandra N. McCready, Town Clerk

A. Planning and Zoning Board

Mayor Burkett appointed Fred Landsman whose qualification meets the resident criteria.

Vice Mayor Paul appointed Judith Frankel whose qualification is her service on the Planning and Zoning Board and she meets the planning background criteria.

Commissioner Velasquez appointed Ruben Bravo whose qualification meets the sustainability and resiliency criteria.

Commissioner Salzhauer appointed Oliver Sanchez whose qualification is being a Surfside resident.

Commissioner Kesl appointed James McKenzie whose qualification meets the architect criteria.

Commissioner Velasquez discussed the issues that presented in the past with lack of quorum to the Design and Review Board.

Vice Mayor Paul addressed Commissioner Velasquez' question regarding quorum for this Board.

A motion was made by Commissioner Salzhauer to appoint herself as the Planning and Zoning Board Liaison, seconded by Vice Mayor Paul. All voted in favor with Commissioner Velasquez and Mayor Burkett voting against.

B. Tourist Board

Mayor Burkett appointed Clara Diaz Leal whose qualification meets the resident and sustainability and resiliency as well as the risk management criteria.

Vice Mayor Paul appointed Ian Marovath whose qualification meets the marketing criteria.

Commissioner Velasquez appointed Eli Tourgeman whose qualification meets the resident criteria.

Commissioner Salzhauer appointed Robert Lisman whose qualification meets the tourist and marketing criteria.

Commissioner Kesl appointed Lisa Herman whose qualification meets the public relations and marketing criteria.

A motion was made by Commissioner Velasquez to ratify all the appointees to the Tourist Board, seconded by Vice Mayor Paul. All voted in favor.

A motion was made by Commissioner Salzhauer to nominate Vice Mayor Paul as the liaison to the Tourist Board, seconded by Commissioner Kesl. All voted in favor with Mayor Burkett voted against.

C. Parks and Recreation Committee

Mayor Burkett appointed Reta Logan.

Vice Mayor Paul appointed Nicole Travis.

Commissioner Velasquez appointed Martha Olchyk.

Commissioner Salzhauer appointed Janice Tatum whose qualification meets the environmental, resiliency and sustainability criteria.

Commissioner Kesl appointed Frank McBride.

A motion was made by Commissioner Velasquez to appoint herself as the liaison to the Parks and Recreation Committee, seconded by Commissioner Kesl. All voted in favor with Commissioner Salzhauer and Vice Mayor Paul voting against.

D. Budget Committee

Mayor Burkett appointed Diana Gonzalez.

Vice Mayor Paul appointed Lauren Bardos.

Commissioner Velasquez appointed Sheryl Goldberg.

Commissioner Salzhauer appointed Andrew Craven.

Commissioner Kesl appointed Bobby Cummings.

A motion was made by Commissioner Kesl to accept all appointments made to the Budget Committee, seconded by Commissioner Velasquez. All voted in favor.

Consensus was reached to appoint Mayor Burkett as the liaison to the Budget Committee. All voted in favor.

E. Pension Board

Discussion among the Commission took place on appointments to the Pension Board.

A motion was made by Vice Mayor Paul to appoint Abraham Issa and Gary Golding as the at large appointments to the Pension Board, seconded by Commissioner Kesl. All voted in favor.

F. Downtown Vision Advisory Committee (DVAC)

Mayor Burkett appointed Zoya Pashenko.

Vice Mayor Paul appointed Meghan Rote.

Commissioner Velasquez appointed Celida Cuenca.

Commissioner Salzhauer did not make an appointment to DVAC at this point.

Commissioner Kesl appointed Marianne Meishcheid.

Consensus was reached to appoint Commissioner Kesl as the liaison for the Downtown Vision Advisory Committee (DVAC). All voted in favor.

G. Police Officers Trust

Discussion among the Commission took place on appointments to the Police Officers Trust.

A motion was made by Vice Mayor Paul to appoint Jose Galimidi and Marení Starre as the at large appointments to the Police Officers Trust, seconded by Commissioner Kesl. All voted in favor.

H. Personnel Appeals Board

Mayor Burkett did not make an appointment to Personnel Appeals Board.

Vice Mayor Paul did not make an appointment to Personnel Appeals Board.

Commissioner Velasquez did not make an appointment to Personnel Appeals Board.

Commissioner Salzhauer did not make an appointment to Personnel Appeals Board.

Commissioner Kesl did not make an appointment to Personnel Appeals Board.

The Commission reached consensus to make appointments to the Personnel Appeals Board at a later meeting.

3. Adjournment

A motion was made by Commissioner Velasquez, to adjourn the meeting without objection at 8:17 p.m. The motion received a second from Commissioner Kesl. All voted in favor.

Accepted this _____ day of _____, 2020.

Charles W. Burkett, Mayor

Attest:

Sandra N. McCreedy, MMC
Town Clerk



**Town of Surfside
Zoning Code Workshop
MINUTES
July 1, 2020
8 p.m.**

Town Hall Commission Chambers - 9293 Harding Ave, 2nd Floor
Surfside, FL 33154

1. Opening

A. Call to Order

Mayor Burkett called the meeting to order at 8:27 p.m.

B. Roll Call of Members

Town Clerk McCready called the roll with the following members present:

Present: Mayor Charles Burkett, Vice Mayor Tina Paul, Commissioner Nelly Velasquez, Commissioner Eliana Salzhauer and Commissioner Charles Kesl.

Also present were Town Manager Guillermo Olmedillo and Town Attorney Lillian Arango.

2. Discussion Items

A. Discussion on Adoption of a New Zoning Code

Commissioner Salzhauer asked Town Attorney Arango if the Commission could direct the administration to enforce mandatory face masks.

Town Attorney Arango advised that they can provide consensus to the Town Manager on the face mask issue.

Town Manager Olmedillo addressed the County's order regarding mandatory face masks.

Commissioner Salzhauer made an opening comment and certain research and loopholes. She spoke regarding ideas of how to close those loopholes.

Mayor Burkett addressed the comments made by Commissioner Salzhauer and spoke regarding term limits of elected officials and pay of those elected officials. He commented on having an emergency meeting to address the

important questions before July 31, 2020 to deal with the ballot questions, flooding, undergrounding, etc.

Commissioner Kesl stated that he would like to get to the basics to determine the issues to be identified in order to move forward like the footprint of the building, budget on making new buildings and making the community more livable and compatible.

Vice Mayor Paul spoke regarding Town Planner James Hickey and the resolution she sent regarding the May 14 2020 agenda dealing with the zoning code and where they need to close the loopholes.

Mayor Burkett spoke regarding the old code and what transpired during that time and read his statement into the record and gave his presentation.

Vice Mayor Paul spoke regarding the unit per acres in the charter amendment and stated that this change took place before and the units per acre were already defined.

Mayor Burkett addressed the comment made by Vice Mayor Paul.

Vice Mayor Paul stated that she had never heard the words gross acre and commented on the 2011 Ordinance and change the definition of acreage.

Mayor Burkett commented on the zoning code and charter amendment.

Commissioner Kesl stated that they should change the language as stated by Mayor Burkett and the definition of the acre and the height and redefining height and changing that language.

Town Planner Hickey spoke about the zoning code and conditional use code and the difference between both of the codes.

Discussion continued among the Commission regarding the development review requirements and changes to the Code.

Commissioner Salzhauer stated that the decision should be how to fix it.

Mayor Burkett suggested to sit down and propose changes that can be circulated and each Commission make their suggestions on the changes.

Vice Mayor Paul spoke regarding changing the deposition and remove the gross acreage and define the acreage and address aggregation of the lots. Density change it to the number of acres and remove gross acreage. Covered patios not counting and she thinks it should count as square footage.

Commissioner Velasquez stated that she does believe that there are areas that need to be addressed and requested to not make changes tonight so she can have time to review the codes.

Commissioner Kesl would like to request the Town staff to look at both codes and obtain a proposal on how to best secure what is best of the code.

Vice Mayor Paul stated that it would be giving direction to staff. She would like to give direction to staff to come back with changes to the 2011 ordinance with the previous area and bring it back to 2006, better define gross acreage, covered porches that need to be addressed and come back with an ordinance.

Mayor Burkett would like to have a list of 10 things to add to the end of the zoning code and fix those 10 things.

Commissioner Salzhauer spoke regarding the proposed ordinance that Town Attorney Arango drafted.

Town Attorney Ed Martos addressed the comments made by Commissioner Salzhauer and explained the definition of lot coverage and the changes that were made.

Further discussion took place among the Commission regarding definition and changes of the code and the language to clean up and make language consistent. They discussed no subdivision of lots only covering 40% of the lot.

Mayor Burkett addressed comments made by the Commission on subdividing the lots.

Further discussion took place regarding the zoning code and using the 2006 code as a baseline to draft a zoning code that will work.

3. Public Comments

Jeff Rose, spoke regarding the fact that the old code is better and the new code is more restrictive and read his comment into the record.

George Kouslouas spoke regarding the zoning code and its changes.

Horace Henderson's statement was read into the record by Deputy Town Clerk Evelyn Herbello.

Laurie Swedroe's email was read into the record by Deputy Town Clerk Evelyn Herbello.

Commissioner Velasquez asked regarding the setback and how it is measured.

Commissioner Salzhauer addressed the comments made by George Kouslouas regarding the thickness of the wall and does it all have to be on your property and not your neighbors.

Mayor Burkett brought up the pictures of two houses side by side and the stairway on the home and those houses being appropriately spaced on those lots.

George Kouslouas made a presentation on what is allowed under the old code and what is the actual of what is being built.

Further discussion took place among the Town Commission regarding the 35% pervious, checking the survey and making sure the home was built correctly.

Mayor Burkett requested to work on a proposal and bring it back as an ordinance once it has been circulated among the Commission for their input.

Vice Mayor Paul stated that she would like to amend the ordinance that she brought and change the definition of density.

Mayor Burkett suggested bringing back both ordinances and fixing them. He asked the Building Official to send to the Commission how these homes get inspected.

Building Official Prieto stated that a Certificate of Occupancy cannot be issued without a final survey.

Mayor Burkett suggested working on the old ordinance and making it better, supply their suggestions on the ordinance that Commissioner Salzhauer started working on and circulate among the Commission in order to address these issues.

Commissioner Salzhauer would like to also address the businesses and hotel areas when addressing and amending the zoning code.

Town Planner Hickey spoke regarding Section 90.23 and its requirements for conditional use.

Mayor Burkett asked regarding the requirements necessary to obtain a permit for conditional use.

Commissioner Salzhauer asked regarding procedure on the interview process for the Town Planner.

Mayor Burkett stated that at the next meeting, make recommendations to determine who is more qualified in order to hire the best Town Planner for the Town.

Mayor Burkett stated to circulate some dates to see what is more convenience with the Commission.

4. Adjournment

A motion was made by Commissioner Velasquez to adjourn the meeting without objection at 10:46 p.m. The motion received a second from Commissioner Kesl. All voted in favor.

Accepted this _____ day of _____, 2020.

Charles W. Burkett, Mayor

Attest:

Sandra N. McCreedy, MMC
Town Clerk



Town of Surfside
Special Joint Town Commission and Pension Board Meeting
AGENDA

July 6, 2020

9293 Harding Ave, 2nd Floor
Surfside, FL 33154

1. Opening

A. Call to Order

Mayor Burkett called the meeting to order at 2:14 p.m.

B. Roll Call of Members

Town Clerk McCready called the roll for the Town Commission with the following members present: Mayor Burkett, Commissioner Kesl, Commissioner Salzhauer and Vice Mayor Paul and Commissioner Velasquez arrived (2:52 p.m.)

Recording Clerk Duval called the roll for the Pension Board with the following members present: Chair Abraham Issa, Board Member Yamileth Slate-McCloud, Board Member Sgt. Julio Torres, Board Member Guillermo Olmedillo (arrived at 2:23 p.m.)

Absent: Board Member Golding

Also present were Pension Board Attorney Adam Levinson, Pension Board Attorney Robert Klausner, Interim Assistant Town Manager/Finance Director Jason Greene, Town Attorney Lillian Arango and Pension Board Actuary Nicolas Lahaye.

2. Pension Board Members and Consultant Introduction

Chair Issa gave an introduction of the Pension Fund and the portion of the Budget Fund, liabilities and assets. Chair Issa read his statement into the record explaining the pension fund, the Town's employees and police officers, while balancing the assets and making it best for the Town.

Chair Issa explained the layout of the Pension Board and its members. He asked the Pension Board members to introduce themselves.

The Pension Board members introduced themselves along with their expertise. The Pension Board members that introduced themselves were Pension Board member Yamileth Slate-McCloud, Pension Board member Police Sgt. Julio Torres, Pension Board Chair Abraham Issa and Pension Board member Guillermo Olmedillo.

Chair Issa explained the process of this meeting and the topic of today's meeting.

Pension Board Attorney Adam Levinson introduced himself and Pension Board Attorney Robert Klausner.

3. Pension Presentation

Pension Board Attorney Klausner introduced himself and provided a PowerPoint presentation to the Pension Board and Town Commission.

Commissioner Salzhauer asked why there was a pension plan in the public sector when it has been determined in the past that it does not work. She also asked regarding the difference between this Town's pension plan and a 401K retirement plan.

Pension Board Attorney Klausner explained that a defined benefit pension plan model is less expensive than the defined contribution plan. He stated that a pension plan will produce longevity in employees. The 401K pension plan is not constitutional for government pension plans. He stated that a defined benefit plan pays for itself.

Commissioner Salzhauer asked who came up with the changes to the new plan.

Chair Issa answered Commissioner Salzhauer's question and stated that it was Board Member Slate McCloud in conjunction with research comparison that she performed. He also stated that with the legislation being introduced, the 401K plans will look more like a defined benefits plan.

Commissioner Velasquez asked why the eligible age of retirement was lowered by 12 years. She stated that she believes that if you lower the retirement plan it should be up to the residents to decide.

Mayor Burkett stated that he agrees with Commissioner Salzhauer and Commissioner Velasquez in regards to lowering the retirement age.

Pension Attorney Klausner stated that the lowering of the age was more due to the public works employees being too old to do the job and referred to the PowerPoint presentation.

Commissioner Salzhauer commented on the management benefits of lowering the age and years of service and increasing the management percentage to 80%.

Pension Attorney Levinson explained the calculation of the pension plan and the percentage an employee would take is dependent on their years of service and explained the difference in pension plans.

Mayor Burkett spoke regarding the 5-year highest salary when it comes to determining the pension income. He discussed the pension plan in 2016 and it was the last time there were significant changes to the pension system. He spoke regarding the cost of a defined benefit pension plan to the Town.

Chair Issa addressed the comments made by the Town Commission and Mayor Burkett as well as their concerns regarding the pension.

Pension Board member Slate McCloud addressed the comments made by the Town Commission regarding the pension plan, benefits and the comparisons.

Commissioner Kesl stated that he agrees with the general consensus and spoke regarding the pension plan as it relates to the residents and employees.

Commissioner Kesl left the meeting at 3:30 p.m.

Commissioner Salzhauer commented on the amount of years of service and age for retirement. She asked for an explanation of the DROP program.

Chair Issa addressed the comments made by Commissioner Salzhauer on the pension income the employee would be taking once they retire.

Mayor Burkett requested the Pension Board advise the Commission exactly what the difference is with the pension plan that was in effect 10 years ago to the pension plan that is being introduced now. He requested to have a simple spreadsheet showing the differences as a side by side comparison to what they had in 2010 and what they have in 2020.

Pension Board Attorney Levinson explained what the DROP program is and how it works.

Further discussion took place among the Town Commission and Pension Board Members regarding the pension plan as well as employee turnover.

Vice Mayor Paul summarized the 2016 changes and spoke regarding the increase in the employees' contributions which did not increase the Town's contribution. She spoke regarding the comparison of other Towns which were the same size as Surfside. She stated she is here to protect what is in place currently.

Mayor Burkett stated this is a global issue and believes that the tax payers should have a say regarding the pension. He also stated that they should allow the residents to have a say about it and it should be placed on the ballot. He suggested the language to state to have the pension benefits to be the way they were in 2010 or if the Town should go to a 401K pension plan. He also suggested discussing this topic at the special meeting they currently have scheduled that will address which items will be placed in the November 2020 ballot.

Mayor Burkett requested the 2010 Pension Rules and Regulations and 2020 Pension Rules and Regulations be given to all the Commissioners for the Commission to review.

Further discussion took place among the Town Commission and the Pension Board regarding the changes of the pension plan and lowering the retirement age.

Pension Board Member Olmedillo gave the Pension Board and Town Commission his input on how the employees will react with these changes.

Chair Issa gave a synopsis of the direction of what the Commission is requesting. He spoke regarding the Ordinance the Commission passed in late January 2020 and they can see the differences from 2009 through the ordinance that changed the pension plan in 2020. Chair Issa will also include the 2009 pension rules and regulations as well as the current pension rules and regulations.

Pension Board Actuary Nicolas Lahaye commented that the 80% for management was already in place. He also commented on Mayor Burkett's comments in regard to the funding ratio and stated that not much has changed from 2012 to 2018 because 2016 was paid for by the Town employees and to date has not cost much to the Town. He further commented on the percentage of funding ratio and progress was made and they are back to 89% funded. He offered suggestions on how to make amendments to the plan by possibly placing the cap instead of 80% to 90% and raising the retirement age.

Chair Issa spoke about the idea that was given in the past of the Town by placing money into a reserve that does not get used unless it is needed in order by the Town to pay the Town's pension contribution. This will assist in partially funding the contribution for the year that the Town needs assistance.

Mayor Burkett addressed the suggestions made by Pension Board Actuary Lahaye.

4. Questions and Answers

5. Public Comments

Jeff Rose stated that if you want to maintain good employees you need to pay them appropriately and give them a good pension plan as well.

6. Adjournment

There being no further business to discuss before the Town Commission, Commissioner Velasquez made a motion to adjourn the meeting, seconded by Vice Mayor Paul, to adjourn the meeting without objection at 5:39 p.m.

A motion was made by Pension Board Member Olmedillo and seconded by Pension Board Member Sgt. Torres to adjourn the Pension Board meeting without objection at 5:39 p.m.

Respectfully submitted,

Accepted this _____ day of _____, 2020.

Charles Burkett, Mayor

Attest:

Sandra McCready, MMC
Town Clerk



TOWN MANAGER'S REPORT

JULY 14, 2020

COMMUNITY PROGRAMS / INITIATIVES / ENHANCEMENTS

- I. SEE CLICK FIX REPORT – *Attachment "A"*
- II. SOCIAL MEDIA (NEXTDOOR) REPORT – *Attachment "B"*
- III. DEVELOPMENT APPLICATION PROCESS (2009 – PRESENT) – *Attachment "C"*
- IV. TOWN DEPARTMENTS

Code Compliance Division

A. Code Violation Cases: As of June 28, 2020, the total number of active, open cases being managed is 230; of these cases, 116 cases are still under investigation and are working towards compliance; 13 cases are on-hold; 21 cases are in the Special Master hearing queue; 3 cases are in the post-hearing status; 1 case has pending liens, 42 code cases have been issued liens and remain unpaid, and 34 service cases have been issued liens and remain unpaid. Properties with unpaid liens are sent reminder letters on a semi-annual basis.

B. Collected Civil Penalty Fines: Unresolved code compliance cases accrue fines until the code violation is resolved. After the violation is abated, then the property owners are notified to remit the fine amount due. In many cases, the fine amount is either paid, resolved via a settlement agreement, or referred to the Town's Special Master for a hearing and ruling on the fine amount due.

The following is a summary by fiscal year of the fine amounts collected by the Town:

- FY 19/20: Through June 28, 2020, 85 cases have paid/settled for a total collection of \$85,034.
- FY 18/19: 143 cases paid/settled for a total collection of \$35,654.
- FY 17/18: 92 cases paid/settled for a total collection of \$29,576.

- FY 16/17: 117 cases paid/settled for a total collection of \$40,842.
- FY 15/16: 152 cases paid/settled for a total of \$137,282

Finance Department

Monthly Budget to Actual Summary as of May 31, 2020 – *Attachment “D”*

Police Department

A. Police Department Statistics (June 1 – June 23, 2020)

- Traffic Citations – 274
- Parking Citations – 392
- Arrests – 4
- Dispatch Events – 1,593
- Incident/Crime Reports - 38
- Suspicious Person Checks – 17

B. Coronavirus (COVID-19) Update

The Surfside Police Department has maintained situational awareness of the COVID-19 Pandemic Incident in coordination with Local, State, and Federal partner Agencies and through continued contact and information sharing with the Miami-Dade County Office of Emergency Operations-Emergency Operations Center. Our Department strives to maintain operational readiness, public preparedness, safeguarding the community, and enforcement of laws-ordinances-governmental orders.

C. Coronavirus (COVID-19) Related Actions:

- Surfside Police Department personnel conducted beach and business checks for compliance with COVID-19 related County and Town Orders
- Daily Communications with Miami-Dade Emergency Operations Center
- Miami-Dade EOC WebEOC COVID-19 Municipal Protective Actions - Situation Reports
- Delivery of food items, and medication to residents as requested through COVID-19 Task Force
- Daily Patrol Shift Monitoring of Street Ends at Waterways

D. Coronavirus (COVID-19) Community Initiatives

- The Surfside Police Department has delivered 24 care packages to seniors/residents-in-need, delivered 62 masks and vital COVID 19 information to 29 residences

(seniors-in-need) who are unable to leave their homes due to mobility issues. Police Department personnel are dedicated to the community they serve and well-being of all residents.

E. Police Events/Community Outreach

- Chief Yero participated in a Zoom Community Meeting hosted by the Miami-Dade County Association of Chiefs of Police on June 5th at 3:00 p.m. The purpose of this meeting was for Chiefs from all Miami-Dade County municipalities to meet with community members to discuss police use of force and community relations following the tragic death of George Floyd.
- The Miami Dolphins hosted a 5000 Role Models of Excellence Project event on June 11th from 5:00 p.m. to 8:30 p.m. at the Hard Rock Stadium. The event encourages dialogue between youth and law enforcement. Chief Yero, Lt. Marciante and Officer Carrasquillo attended the event representing the Surfside Police Department.
- Monthly community events (Bike with the Chief and Coffee with the Cops) are cancelled until further notice and will resume as soon as possible.
- The Shred-A-Thon, DEA Drug Take Back and Mobile DMV will be rescheduled as soon as possible.

F. Traffic Mitigation Program Status Report

Public safety is the number one priority for the Town of Surfside. Along with public safety, quality of life is a focus of the Town. One element that impacts both public safety and quality of life is traffic. Traffic has increased significantly in recent years on Collins Avenue and Harding Avenue regionally as well as locally in Surfside. These roadways are major north/south thoroughfares for vehicles to avoid I-95 and Biscayne Boulevard traffic congestion. Lane closures at developments in Surfside and neighboring jurisdictions add to this traffic overcrowding. Drivers have learned they can avoid the backup on Collins Avenue and Harding Avenue by traveling west into the residential neighborhoods. There are no sidewalks in the single-family home areas of Surfside and with many families and children who play, walk and bike on the streets, traffic mitigation strategies are continuous for the Town Commission and Staff in our goal to keep Surfside safe and enjoyable. In order to accomplish our goals Staff works in partnership with the State of Florida Department of Transportation and Miami-Dade County authorities who have jurisdiction over the roads in Surfside. The following chart illustrates and tracks the progress of this ongoing effort.

#	TIMEFRAME	INITIATIVES	STATUS	UPDATE(S)
Short Term (0 – 6 months)				
1.		Loop Detector Installation	In progress	CGA was authorized to move forward with the preparation of the bid documents for the traffic loops at three signalized intersections

			<p>along Harding Avenue. CGA will need to provide updated scope of services and fee in order to provide traffic counts and traffic analysis at subject intersections (before and after traffic analysis) per commission request at 05-09-17 meeting.</p> <p>The east Stop Bar at 93 Street & Harding Avenue will be moved back.</p> <p>On 8-8-2017, CGA submitted its additional service agreement for completing the before and after traffic analysis at the signalized intersections along Harding Avenue that new traffic loops are being installed. At the Commission meeting where the Post Design Services contract was approved, the Mayor and Commission asked if CGA could do a before and after analysis in order to evaluate the change in traffic operations at these subject intersections. The traffic counts are currently scheduled for the 29th, 30th or 31st of August (second week of regular school).</p> <p>Loop detectors have been approved for Harding Avenue at 88th, 93rd and 94th Streets.</p> <p>On 11-3-2017, CGA submitted for review and approval Work Authorization No. 106 for Surfside Traffic Signal Modification – Traffic Analysis. The scope of the project includes Pre – Post Construction Analysis of four intersections on Harding Avenue at 88th, 93rd, 94th and 95th Streets. Total cost not to exceed \$14,200.62.</p> <p>On 1-29-2018, a Traffic Signal Modification Mandatory Pre-Bid Opening was held at 10:30 a.m. The Assistant Town Manager, CGA, Public Works and Police Department representatives attended. No bidders attended.</p> <p>On March 8, 2018, a Traffic Signal Modification Mandatory Pre-Bid Opening was held at 2:00 p.m. The Town has received two bids. The Public Works Department and CGA are evaluating the bids. Once the bids are evaluated and ranked, Town staff will present their recommendation for final bid selection and award to the Town Commission.</p>
--	--	--	---

			<p>In a letter dated April 16, 2018, reference Town of Surfside Traffic Signal Modifications ITB No. 2018-01 and CGA Project No. 15-8083, CGA Director of Construction Engineering, Robert McSweeney, provided an analysis of the two bids received for the Surfside Traffic Signal Modification Project and recommendation for award of Contract. Under Power Corp. was the apparent low bidder with a Base Bid of \$109,045.23. Upon review, they found the bid is complete and appropriate for the proposed work. In keeping with the Town to award a Contract to the most responsible and responsive bidder whose bid is in conformance with the Bidding Documents and is in the best interest of the Town, they recommend that the Town of Surfside award the contract for the referenced project to Under Power Corp.</p> <p>At the 6-12-2018 Commission Meeting, the Town Commission voted to approve the recommendation from CGA awarding the contract to Under Power Corp. The project is moving forward pending CGA Notice to Proceed and required permitting.</p> <p>CGA has collected traffic counts and completed intersection analysis at the Harding Avenue and 88th Street, Harding Avenue and 93rd Street, Harding Avenue and 94th Street and Harding Avenue and 95th Street intersections. Next step is to complete new traffic counts and intersection analysis once the traffic loops at all four intersections have been installed. This traffic analysis will be summarized in a memorandum.</p> <p>Public Works Department and CGA held a pre-con meeting. Contractor applied for County permit. A Notice to Proceed (NTP) will be given when contractor has permit. 30 to 45 days for completion after start.</p> <p>On 8-8-2018, the awarded contractor, Under Power Corporation, submitted the following permit applications to Miami Dade County: Permit No. 2018006371 – Harding Av & 88 St Permit No. 2018006374- Harding Ave & 93 St Permit No. 2018006373 – Harding Ave & 94 St</p>
--	--	--	---

			<p>On 8-21-2018, Miami-Dade Traffic Engineering Division provided comments on their already approved plans. They had asked for one of the pedestrian signal phases to be modified.</p> <p>On 8-22-2018, Under Power Corporation picked up 18 revised signed and sealed sets from CGA.</p> <p>On 8-23-2018, the revised plans were submitted to the County for permitting by the contractor. It seems that the County has a 12-day turn-around for these permits. Bob McSweeney has been keeping track of the County’s review time and the contractor has kept CGA informed every step of this process.</p> <p>For Harding Avenue and 95th Street, CGA received an email from David Hayes (Miami-Dade County) stating that they could not sign-off on the project because they needed revised plans to reflect the same pedestrian phase modifications requested at 88th Street, 93rd Street, and 94th Street. Revised plans for Harding Avenue and 95th Street will be submitted to Miami-Dade County on 8-27-2018.</p> <p>Under Power Corp., project manager Guillermo Vado, left the company on 09-14-18, and the new project manager is Eddie Macias e.macias@underpowercorp.com.</p> <p>GCA contacted FDOT Operations concerning the Construction Agreement renewal and loop material revision, and were referred to the FDOT Permits Department. GCA have a call/message into them, and will advise as to any potential delay once we have more information.</p> <p>On 11-27-18 a meeting was conducted with Town Administration, Public Works, Police Department, and CGA regarding the Loop Detector Installation. It was determined that the project can commence on 12-10-2018 and the work hours will be 8:00 AM – 6:00 PM, Monday-Friday. The Police Department will provide personnel to assist with lane closures. The contractor, Under Power Corp., was contacted and advised to provide a construction schedule, work plan narrative,</p>
--	--	--	--

			<p>and MOTs regarding the program prior to commencing work.</p> <p>Loop Detector installation work began the week of 12-17-2018 and FDOT advised that the contractor has a 90-day window to complete the work. Traffic advisories were emailed to residents and posted on the Town website regarding the construction work and anticipated lane closures on Harding Avenue.</p> <p>FDOT halted the installation to obtain additional permits. They were not able to perform directional drilling at the intersections. FDOT and the Town have a scheduled meeting on Thursday 01-31-2019 to discuss the new project timeline.</p> <p>As of February 2019, due to unforeseen field conditions encountered by Contractor, loop detection project construction drawings are being revised. The revised drawings will be submitted to FDOT for re-permitting since the changes require trenching of roadway. Engineer of Record is currently working on construction drawings for re-submittal.</p> <p>According to the Town Public Works Department we are awaiting a cost on the Change Order.</p> <p>In April 2019, Public Works advised that an RFP will have to be re-issued as the contractor has withdrawn from the project.</p> <p>The Loop Detectors are a discussion item for the November 2019 Commission Meeting.</p> <p>The Loop Detectors was a discussion item for the November 2019 Commission Meeting. Commissioner Kaukin commented on the traffic impact on the intersection of 94th Street and Harding Avenue. Town Manager Olmedillo suggested engaging with FDOT regarding the loop detector project and obtain a cost share partnership. The Town Manager stated he will contact FDOT and report back to the Commission.</p> <p>FDOT retained Tindale-Oliver & Associates, Inc. to design a pushbutton project to install the requested vehicle detectors (loops)</p>
--	--	--	---

				<p>along SR A1A/Harding Avenue at the following locations:</p> <ul style="list-style-type: none"> • 93rd Street • 94th Street • 95th Street <p>A FDOT representative advised that the installation will tentatively start sometime around summer of 2020.</p>
2.		<p>Install a crosswalk at 90th Street & Harding Avenue (north side) and 89th Street & Harding Avenue (north side)</p>	Open	<p>FDOT agreed to reconsider installing a traffic signal at the location, pending study (count). The Town installed traffic delineators designed to allow a left turn only onto Harding Avenue, preventing vehicles from traveling westbound across the intersection.</p> <p>The 200 block of 90th Street has been converted to one-way traffic eastbound only. This new traffic pattern has eliminated the hazard of vehicles traveling west across Harding Avenue at 90th Street where a curve hindered line of sight for drivers.</p> <p>No Turn on Red signage has been installed at 90th Street & Collins Avenue for vehicles traveling eastbound in the 200 block of 90th Street.</p> <p>Crosswalk markings (Thermoplastic) installation will be performed in February 2019.</p> <p>Crosswalk markings (Thermoplastic) installation was delayed until March 2019 to allow the new pavement to properly cure.</p> <p>Crosswalk markings (Thermoplastic) installation was completed at the 89th Street & Harding Avenue (north side) location in March 2019. The Crosswalk markings (Thermoplastic) installation at 90th Street & Harding Avenue (north side) is still pending with no definitive date set.</p>
3.		<p>Install a crosswalk at 92nd Street & Collins Avenue (FDOT Project)</p>	Open	<p>Based on citizen concerns, the Town Administration contacted FDOT regarding the installation of a crosswalk at 92nd Street and Collins Avenue to enhance pedestrian safety for Town residents and hotel guests of the Residence Inn by Marriott Hotel.</p>

				Town Public Works contacted FDOT for an update on this project on 09-23-2019, and was advised that the project is approved under FDOT Project #FM 250629-5-32-01 and is awaiting project funding.
4.		Evaluate Sidewalk Options	Open	Town Commission approved a motion to continue to evaluate pedestrian safety options in Surfside.
5.		Collins Ave and Harding Ave. Request for additional speed limit signs & pavement markings within Town of Surfside. FDOT CTP 2018-03-0031	<u>CLOSED</u>	<p>Per Arturo Patulot, Traffic Operations D6, Florida Department of Transportation (FDOT) 305-470-5303, arthuro.patulot@dot.state.fl.us: FDOT Traffic Operations office conducted a field review along the subject roadway segment from 88th to 96th streets both NB and SB directions and has decided to install five (5) additional posted speed limit signs 30 MPH and three (3) sets of pavement markings 30 MPH for better exposure and driver’s compliance at the following locations:</p> <p><i>Collins Avenue facing Northbound traffic</i> Two (2) additional 30 MPH speed limit signs (Right & Left of roadway) and 30 MPH pavement markings north of 90th Street One (1) additional 30 MPH speed limit sign (Right of roadway) north of 92nd Street Two (2) additional 30 MPH speed limit signs (Right & Left of roadway) north of 94th Street</p> <p><i>Harding Avenue facing Southbound traffic</i> 30 MPH pavement markings for the three lanes across from existing speed limit sign south of 96th Street 30 MPH pavement markings for the three lanes across from existing speed limit signs south of 92nd Street</p> <p>The proposed improvements will be completed by FDOT maintenance when workload and schedule permit. No anticipated completion dates were provided.</p> <p>FDOT was notified by email for an update on the status and Public Works is awaiting their response.</p> <p>Town Public Works advised that FDOT confirmed that a work order has been completed and pending a start date for the work.</p>

				<p>Town Public Works Administration contacted FDOT on 09-23-2019, and obtained the following update from Arturo Patulot (FDOT Traffic Operations D6):</p> <ul style="list-style-type: none"> • FDOT traffic service request (TSR #87-0033-18) with the FDOT maintenance office is being processed and they will be expediting the implementation of the proposed improvements for Surfside on A1A • The FDOT contractor is scheduled to start installing the pavement markings and signage the first week of October 2019. <p>FDOT began installing the pavement markings and signage the week of October 21, 2019.</p> <p>As of November 2019, the status of the pavement markings is as follows:</p> <ol style="list-style-type: none"> 1. 9500 Block of Harding (Completed) 2. 9300 Block of Harding (Completed) 3. 9100 Block of Harding (Completed) 4. 9000 Block of Collins (Completed) 5. 9200 Block of Collins (Not Completed) 6. 9400 Block of Collins (Not Completed) <p>FDOT Supervisor, Ramon Sierra, advised the Surfside Public Works Department that all signs and markings for the project have been completed.</p>
6.		Installation of Traffic Delineators	Closed	<p>Traffic Delineators were installed at designated traffic concern locations identified by the Police Department at Collins Avenue at 92 Street (NW corner) and in the 9100 block of Collins Avenue (west side). The Delineators were installed in February 2020, and have proven effective in eliminating the illegal parking at these locations.</p>
7.		New Speed Bumps	Closed	<p>New speed bumps have been installed at the following locations:</p> <ul style="list-style-type: none"> • 8900 block of Abbott Avenue • 9100 block of Abbott Avenue • 9300 block of Abbott Avenue • 9500 block of Byron Avenue (second speed bump)

				<p>November/December 2018: new speed bump location in the 9400 block of Abbott Avenue being evaluated. The location of the speed bump was determined and installation scheduled for February 2019.</p> <p>During February 2019, new speed bumps were installed at the following locations:</p> <ul style="list-style-type: none"> • 9300 block of Abbott Avenue • 9400 block of Abbott Avenue • 9500 block of Carlyle Avenue <p>New speed bumps implementation is being evaluated for the 8800 block of Carlyle Avenue.</p> <p>In May 2019, a speed bump was installed in the 8800 block of Carlyle Avenue.</p> <p>On October 23, 2019 one speed bump was removed from 88th Street due to its proximity to an existing stop sign.</p>
8.		Stop Signs in Surfside checked for compliance with Miami-Dade County regulations.	Closed	<p>During September 2019, Town Public Works personnel checked and adjusted all stop signs in Town to ensure that they were upright, and were in compliance with the 7 foot height per Miami-Dade County regulations.</p>
9.		Pedestrian Crosswalk Safety at the 93 rd Street and Collins Avenue Crosswalk	Closed	<p>Based on citizen concerns and traffic crash data, the Town Manager and the Police Department initiated the following actions to enhance pedestrian safety at the crosswalk located at 93rd Street and Collins Avenue that is used to primarily access the Town’s Community Recreational Center.</p> <p>In June 2019, the Town Manager met with Florida State Senator Jason Pizzo, Kevin J. Thibault (Secretary of Transportation), Miami-Dade County Commissioner Sally Heyman, and Jim Wolfe (Secretary of District 6, Florida DOT) and he presented the safety issues regarding the pedestrian crossing at 93rd Street and Collins Avenue and sought input and recommendations to mitigate those concerns.</p>

			<p>The Police Department conducted on-going proactive traffic details in the 9200 block of Collins Avenue targeting speeding vehicles and vehicles running the red light. Additionally, the Police Department partnered with FDOT representatives to conduct a pedestrian safety educational awareness day that included the 93rd Street and Collins Avenue intersection and pedestrian crossing to educate citizens and provide safety tips.</p> <p>The Police Department contacted both FDOT and the Miami-Dade Traffic Department of Transportation and Public Works Traffic Signals and Signs Division Administration to request that the timing of the traffic signal at 93rd Street and Collins Avenue be increased to allow additional time for pedestrians to cross Collins Avenue for eastbound and westbound travel. This effort was successful and the County agreed to increase the pedestrian crossing time by an additional 3 seconds which was implemented on August 27, 2019. The pedestrian walk time now reflects a minimum of 7 seconds prior to the 16 second countdown timer of the flashing “DON’T WALK” notification, providing pedestrians a total of 23 seconds of crossing time.</p> <p>Isis Sotolongo, FDOT Bike and Pedestrian Traffic Specialist II–District Traffic Operations Division, sent an email to Town Manager Olmedillo on 11-15-19 regarding a completed FDOT engineering study for 93rd Street intersections at Collins Avenue and Harding Avenue. The email is copied below:</p> <p>Subject: CTP 2019-08-0006, Sections: 87060000 & 870600001, SR A1A / Collins Avenue and SR A1A / Harding Avenue at 93rd Street. Request for Pedestrian Safety improvements.</p> <p>Good morning Mr. Olmedillo, This is a follow-up to a request you forwarded to our office on August 26, 2019 to further evaluate pedestrian and bicycle mobility at the subject intersections. The Florida Department of Transportation</p>
--	--	--	---

			<p>completed a traffic engineering study which included turning movement counts, pedestrian counts, review of crash data, field observations and assessment for potential pedestrian/bicycle safety and mobility enhancements. Based on the results of the study, the Department has decided to implement the following safety improvements at SR A1A/Harding Avenue and 93rd Street and SR A1A/Collins Avenue and 93rd Street.</p> <ul style="list-style-type: none"> • Coordinate with Miami-Dade County Traffic Signals and Signs Division to add three seconds of “WALK” time indication to the north and south leg crosswalks at the intersection of SR A1A/Harding Avenue and 93rd Street. • Coordinate with Miami-Dade County Traffic Signals and Signs Division to add three seconds of “Flashing Don’t Walk” (FDW) time to the east and west leg crosswalks at the intersection of SR A1A/Harding Avenue and 93rd Street. • Install “Special Emphasis” crosswalk markings on the south and west legs of the intersection of SR A1A/Collins Avenue and 93rd Street similar to the ones provided on SR A1A/Harding Avenue and 93rd Street. • Relocate the post mounted “Pedestrian Crossing” (W11-2) sign and “One Way” (R6-1) sign located on the southwest corner of the intersection of SR A1A / Harding Avenue and 93rd Street to allow full visibility of countdown pedestrian signal heads for the south and west crosswalks. • Replace existing detectable warnings on all corners of the intersection of SR A1A/Harding Avenue and 93rd Street with ADA compliant yellow detectable warnings. <p>The Department appreciates the time and effort you have taken in bringing this matter to our attention, and looks forward to address your concerns.</p>
--	--	--	--

<p>10.</p>		<p>95th Street & Harding Avenue (westbound), left Turn lane added. 300 block of 95th Street (eastbound), right turn lane added.</p>	<p>Closed</p>	<p>On 04-27-2017, the traffic lanes in the 200 block of 95th Street, between Collins Avenue and Harding Avenue were modified to improve the traffic flow. New lane pavement markers delineate the new vehicular traffic flow for westbound traffic on 95th Street approaching Harding Avenue. The pavement markings allow vehicles to travel in two lanes west of the alleyway with one lane designated for travel westbound only on 95 Street across Harding Avenue, and the other lane designated as a left turn only lane for vehicles turning southbound onto Harding Avenue. Three parking spaces on the North East side of 95 Street & Harding Avenue have been eliminated to allow for a westbound travel lane.</p> <p>As of 08-22-2017, the traffic flow in the 300 block of 95th Street, between Abbott Avenue and Harding Avenue, has been altered. The new lane pavement markers delineate the new vehicular traffic flow for eastbound traffic on 95th Street approaching Harding Avenue. The pavement markings allow vehicles to travel in two lanes east of the alleyway with one lane designated for travel eastbound only on 95th Street across Harding Avenue, and the other lane designated as a right turn only lane for vehicles turning southbound onto Harding Avenue. The loading zone at this location has been eliminated to allow for a right turn only lane. Please refer to the traffic diagram below.</p> 
<p>11.</p>		<p>New Stop Signs at all intersections west of Harding Avenue</p>	<p>Closed</p>	<p>Public Works installed stop signs at the following locations:</p> <ul style="list-style-type: none"> • 89th Street & Byron Avenue (east-west) • 90th Street & Abbott Avenue (east-west) • 90th Street & Carlyle Avenue (east-west)

				<ul style="list-style-type: none"> • 92nd Street & Abbott Avenue (east-west) • 92nd Street & Carlyle Avenue (east-west) <p>In September 2018, Public Works relocated the stop sign and stop bar at Carlyle Avenue and 90th Street (for Northbound traffic on Carlyle Avenue) 15 feet north to allow for an enhanced traffic sight cone at the intersection.</p> 
12.		New Stop Bar Reflectors	Closed	<p>New Stop Bar Reflectors Installed</p> <p>In September 2018, Public Works conducted an inspection of the Stop Bar Reflectors and determined which reflectors were non-operational. The vendor replaced the non-operational reflectors under warranty.</p> <p>Public Works ordered 24 new reflectors that were installed at the following locations:</p> <ul style="list-style-type: none"> • 90th Street and Froude (all directions) • 90th Street and Byron (all directions) • 90th Street and Abbott Avenue (East and West directions) • Yellow reflectors were installed prior to the speed bumps in the 9500 block of Byron Avenue to alert drivers. <p>During November 2018 all non-operational Stop Bar Reflectors were replaced and are now functional. Additionally, new Stop Bar reflectors were installed at the following locations:</p> <ul style="list-style-type: none"> • 90th Street and Froude (all directions) • 90th Street and Byron (all directions) • 90th Street and Abbott Avenue (East and West directions)
13.		Revisit Street Closure	Closed	Town Commission approved a motion against revisiting this item.

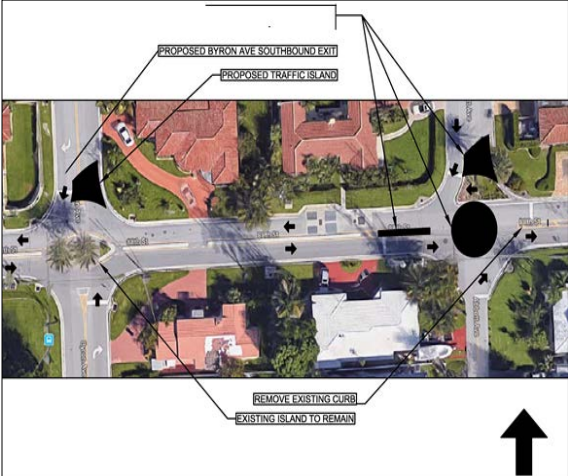

		<ul style="list-style-type: none"> o 94th Street / Abbott Avenue 		
<p>14.</p>		<p>New Street Closure Byron Avenue (northbound) at 88th Street</p>	<p>Closed</p>	<p>Requires study, Miami-Dade County and Miami Beach approval.</p> <p>On 11-29-17, Town Manager, Chief Allen and Public Works Director attended a meeting with Miami-Dade County and City of Miami Beach administration regarding the closure of northbound traffic at 88th Street and Byron Avenue.</p> <p>The above meeting resulted in a plan to add curbing to the 88th Street median extending it to Abbott Avenue. The result will prohibit drivers from executing illegal U turns disrupting the traffic flow and area residents which has been a continuous problem.</p> <p>The following traffic modification Project has been developed to improve the traffic flow at 88th Street and Abbott Avenue.</p>  <p>Public Works completed the installation of the pictured vehicular traffic pattern at 88th Street & Abbott Avenue. On March 12, 2018, a 60-day testing period will begin before final approval.</p> <p>The 60-day trial period before final approval continues. There have been no traffic accidents reported and no matters of concern have been brought to the attention of the Police Department.</p> <p>At the Special Town Commission Meeting held May 22, 2018, the Town Commission approved the below traffic pattern design (Option A) for 88th Street and Abbott Avenue. A traffic circle at Abbott Avenue on 88th Street will allow traffic to flow east, west and south. Traffic islands on Abbott Avenue and Byron</p>

				<p>Avenue at 88th Street will prevent vehicles from traveling north on those avenues from 88th Street.</p>  <p>Public Works has begun work on the new traffic mitigation design on 88th Street & Abbott Avenue. The project is estimated to be completed by mid-July.</p> <p>Project completed.</p>
15.		Install a centerline curb on 95 th Street between Abbott and Byron Avenues	Closed	Public Works installed delineators to deter trucks from traveling west on 95 th Street.
16.		Eliminate Crosswalks on Collins (north) & Harding (south) Avenues	Closed	FDOT stated that eliminating crosswalks would hinder pedestrian travel and further study would be required before they can agree to that recommendation.
17.		Create Vehicular Circulation Plans for New Construction Projects Minimize lane closures	Closed	MOT’s and circulation plans for new construction projects was a primary topic of discussion with FDOT and the surrounding jurisdictions representatives. A plan to improve the coordination of projects and to enhance communication by FDOT providing notice well in advance of all approved MOT’s to the three jurisdictions was agreed upon. The early notice system has shown an improvement.
18.		Install traffic light at 96 th Street & Abbott Avenue	Closed	Town Manager Olmedillo, Chief Allen, Captain Yero and Randy Stokes, from the Town and Eric Czerniejewsky from CGA, spent a few hours with Ramon Sierra, FDOT District 6. Several simulations were run, and

		Eliminate left hand turn at 96 th Street & Byron Avenue		<p>the result is that the back-up traffic in the east bound direction made congestion worse on 96th Street. This will not allow the vehicles turning right from Byron to move, causing a longer back-up on Byron and creating additional congestion on Harding and Collins.</p> <p>FDOT will not eliminate the left turn at 96 Street & Byron Avenue.</p>
19.		<p>Send demand letters to mapping companies</p> <ul style="list-style-type: none"> ○ Waze – Free Community-based GPS, Maps & Traffic Navigation App 	Closed	The Town became a Participating Member of the Connected Citizens Program. This is the Town’s effort to address in real-time reported accidents and improve navigation throughout the Town.
20.		On-Street Parking Reconfiguration - 200 block of 90 th Street	Closed	<p>On Monday 10-08-18, Public Works advised that the 200 block of 90th Street On-Street Parking Reconfiguration would begin in October 2018, with Police/Parking Officers blocking off the street to complete the stripping. Stripping Reconfiguration diagram below.</p>  <p>On Monday 10-29-18, the striping and reconfiguration was completed.</p>
Intermediate Term (7-18 months)				
1.		<p>Design 91st Street Improvements</p> <ul style="list-style-type: none"> ○ Sidewalk, landscaping and buried utilities 	Open	Awaiting the study of walkability by FIU.
2.		Create One-Way Streets 88 th , 89 th , 90 th and 91 st Street between Collins	Closed	A Town meeting was held July 18 th , 2017, to present a new traffic pattern plan making 89 th Street one-way only for westbound vehicular traffic from Collins Avenue to Hawthorne Avenue and 90 th Street one-way

		<p>& Harding Avenues</p>	<p>only for eastbound vehicular traffic from Bay Drive to Collins Avenue.</p> <p>The Town Commission approved to conduct a test of a new streetscape design on 89th and 90th Streets, between Harding and Hawthorne. The test consists of creating a safe pedestrian path and a green area in what is currently the paved area of those streets. Because width of the street will be narrowed during the test, the streets will be changed to a one-way system, with 89th Street traffic moving from east to west and 90th Street traffic moving from west to east. The streets will be marked with paint to designate the pedestrian area as well as the green/parking area. The test is scheduled to begin in early December and run for a period of 60 days. At the end of the test period, staff will present a report to the Town Commission.</p> <p>The new streetscape testing was initiated December 14, 2017. The testing has gone smoothly with no incidents to report thus far. A main focus has been directed toward providing information, answering questions and educating residents and all who travel the area on the details and goals of the project.</p> <p>At the February 13, 2018 Town Commission Meeting the Town Administration was granted time extension of sixty days to the One-Way Street Project in order to survey the streets for ADA compliance in the pedestrian lanes and to acquire more data on traffic counts.</p> <p>A One-Way Streets Town Hall Meeting was held on March 28, 2018. Notifications for the March 28 One-Way Streets Town Hall Meeting have been distributed via the following channels:</p> <ul style="list-style-type: none"> • Publicly Noticed Meetings and Agenda Packets (Town Commission & Planning & Zoning) • Letter mailed to residences on 89th and 90th streets for first meeting held in July (similar to planning & zoning notices) • Door hangers to residences on 89th and 90th streets • Posted notice at Publix and Starbucks
--	--	------------------------------	--

				<ul style="list-style-type: none"> • Multiple e-blasts • Website notices on the calendar and Town news • Included in multiple gazette newsletters • Channel 93 • Nextdoor postings on the Town’s page • Delivery of meeting notices to residencies on 89th and 90th streets for second meeting held in March • Surveys on Nextdoor and SurveyMonkey <p>Town collected resident feedback through a number of these channels including emails and phone calls.</p> <p>At the April 10, 2018 Town Commission Meeting, the Town Commission approved a motion to terminate the One-Way Street Project tested on 89th Street and 90th Street.</p> <p>On April 16, 2018, Public Works returned the traffic pattern on 89th Street and 90th Street to two-way traffic west of Harding Avenue.</p>
3.		Road closure of 95 th Street and Abbott Avenue	Closed	<p>On November 7, 2017, CGA submitted for review and approval Work Authorization No. 108 for Traffic Feasibility Study for Abbott Avenue and 95th Street. The project includes Traffic Analysis and Modeling of the road closure at 95th Street and Abbott Avenue. Total cost will not exceed \$20,149.58.</p> <p>On January 29, 2018, the Town Manager held a meeting with CGA Traffic Engineer Eric Czerniejewski, Asst. Town Manager Duncan Tavares, Public Works Director Randy Stokes and Captain Yero to review and discuss the Feasibility Study results.</p> <p>This item has been deferred due to the impact of closing the 95th Street would generate.</p>
Long Term (19+ months)				
1.		Gate the area west of Harding Avenue and create a special taxing district.	Open	This item is provided here as a place holder.

#	PARKING / TAXIS	STATUS	UPDATE
1.	Create a Resident Only Parking Zone in the north-west section of the 9400 block of Abbott Avenue	Closed	<p>Based on resident requests, a Resident Only Parking Zone was established in the latter part of December 2019 encompassing four parking spaces in the north-west section of the 9400 block of Abbott Avenue. Signage denoting the Parking Zone was procured and installed. Resident only parking decals should be available in January 2020.</p> <p>In January 2020, the Resident Only parking decals were received for the 9400 block of Abbott Avenue and are being distributed.</p>  
2.	The Town of Surfside added 18 new single parking spaces and 2 loading zones in the streets that are east of Collins Avenue. These new parking spaces provide additional parking options for residents and visitors to	Closed	<p>The additional parking spaces are located in the following locations:</p> <ul style="list-style-type: none"> • 100 block of 88th Street (4 spaces) effective 06-01-2017

	<p>our Town. The additional loading zones provide a safe location for trucks and other vehicles to deliver goods and services to residents. The total number of single parking spaces added is now 12.</p> <p>Additional commercial loading zone for the 300 block of 95 Street.</p>	<ul style="list-style-type: none"> • 100 block of 90th Street (4 spaces) effective upon completion of on-going construction project • 100 block of 92nd Street (4 spaces) effective 06-01-2017 • 100 block of 96th Street (6 spaces) six single pay parking spaces were removed and the area was designated a Tow-Away Zone. <p>The additional loading zones are located at the following locations:</p> <ul style="list-style-type: none"> • 100 block of 89th Street - effective 06-01-2017 • 100 block of 94th Street - effective 06-01-2017 <p>An additional loading zone was added at the following location effective Monday 04-22-2019:</p> <ul style="list-style-type: none"> • 300 block of 95 Street on the north-west corner encompassing three parking spaces. The loading zone is effective between 6:00AM – 10:00AM only. <p>In July 2019, an additional loading zone was decided for the 300 block of 95 Street on the south side in the Ride Share zone between the hours of 6AM-10AM. Monday-Friday, to help alleviate commercial truck congestion in the Business District in the early morning hours. The loading zone will be established in August 2019, after ordering and deploying the signs. The new loading zone will be evaluated for a three-month period.</p> <p>In August 2019, the additional loading zone became operational in the Ride Share parking spaces located in the 300 block of 95 Street (south-side) with functional hours of Monday-Friday, 6AM-10AM. The loading zone will be evaluated for a three month period beginning August 1, 2019 and ending on November 1, 2019.</p> <p>The loading zone will be evaluated for a three-month period beginning August 1, 2019 and ending on November 1, 2019.</p>
--	--	--

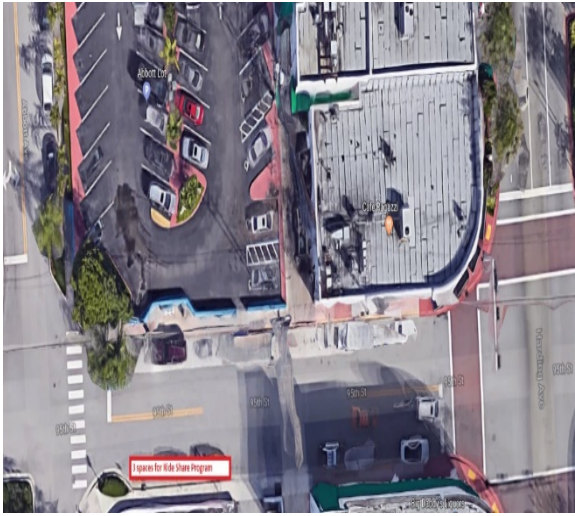
			<p>A memorandum was submitted to the Town Manager regarding the loading zone evaluation for the three-month period beginning August 1, 2019 and ending on November 1, 2019. The memorandum is in support of continuing the loading zone.</p> <p>The additional loading zone in the 300 block of 95 Street (south-side) was approved on a permanent basis with functional hours of Monday-Friday, 6AM-10AM.</p>
<p>3.</p>	<p>Ride Share Pick-up & Drop Off</p>	<p>Closed</p>	<p>Background: There has been a proliferation of citizens utilizing Ride Share services such as Uber and Lyft which has impacted the efficient flow of traffic in the Town of Surfside. The operators for these services have been observed picking up and dropping off their customers in the Surfside Business District occupying Town parking spaces and double parking while picking up or dropping off customers.</p> <p>The Surfside Police Department recommends that a 90 day “Town of Surfside Ride Share Pick-Up & Drop-Off Trial Program” be conducted in the 300 block of 95th Street on the south-side of the road way encompassing three parking spaces closest to Abbott Avenue. See below picture (Red Box Area).</p>  <p>Budget Impact: There will be a reduction in the Town Parking revenue stream due to three (3) less parking spaces being available for paid parking. There will be incurred costs</p>

for procuring signage and possible repainting of the parking spaces.

On 07-20-18 the signs for the Ride Share location were ordered and the expected delivery date is in early August 2018. On 07-26-2018, Captain Bambis and Parking Manager Joseph met with Mr. Javier Correoso (Public Affairs Manager) from Uber ride share regarding the new Pick-up and Drop-off site proposed for the 300 block of 95th Street in Surfside. Mr. Correoso was enthusiastic about the trial program that was discussed with him and he is willing to participate and utilize the location in the Uber application for the Pick-up location. He will be contacted days before going live with the location so that he could initiate the information in the Uber application. Mr. Correoso also provided information for his counterpart at Lyft ride share so we could contact them to have the same information on their Lyft application.

Effective 08-13-2018, the Ride Share Pick-Up and Drop-Off location in the 300 block of 95th Street was completed:

- All signs installed (2 signs)
- Curb line was painted yellow
- Vehicle space lines were painted yellow
- UBER Ride Share Company has agreed to add the location to their application



The Ride Share Pick-up & Drop Off Trial Program concluded on 11-11-18. A Staff Memorandum regarding the program was prepared and submitted by the Police Department which stated that overall impact

			<p>of the Ride Share Pick-Up & Drop-Off Program has been positive and led to efficiencies of the traffic flow in and around the business district of Surfside. The Police Department recommended that the Ride Share Pick-Up & Drop-Off Program continue as a full-time initiative.</p> <p>The Ride Share Pick-up & Drop-off Program became a permanent on-going program effective November 2018.</p> <p>In July 2019, an additional loading zone will be added in the 300 block of 95 Street on the south side in the Ride Share spaces (zone) between the hours of 6AM-10AM, Monday-Friday to help alleviate commercial truck congestion in the Business District in the early morning hours. The loading zone will be established in August 2019, after ordering and deploying the signs and an evaluation period of three months. Based on the loading zone hours added to the current Ride Share spaces an additional Ride Share space will be established in the 200 block of 95 Street on the south side of the street adjacent to or near the loading zone at that location.</p> <p>In August 2019, an additional loading zone became operational in the Ride Share parking spaces located in the 300 block of 95 Street (south-side) with functional hours of Monday-Friday, 6AM-10AM.</p> <p>An additional Ride Share parking zone (single space) is being established in the 200 block of 95 Street (south side) with an anticipated completion date in September 2019, after the Ride Share signage is received.</p> <p>The additional Ride Share parking space in the 200 block of 95 Street (south side) was completed and became operational on Wednesday 09-25-2019. The space was painted and proper signage installed by Town Public Works personnel.</p>
4.	Parking Rate Increase for Off-Street Parking (Municipal Parking Lots)	Closed	Town of Surfside Resolution No. 18-2517 was adopted by the Town Commission on

		<p>07-10-2018 stipulating a parking rate fee increase from \$1.50 per hour to \$1.75 per hour for all Off-Street (Municipal Parking Lot) spaces.</p> <ul style="list-style-type: none"> • New Parking rate decals were ordered for the Parking Pay Stations with an anticipated delivery date of mid-August 2018. • Temporary Parking Fee Decals with the new rate were placed on the affected Parking Pay Stations. • Effective 07-25-18 at 12:00 pm the \$1.75 Parking rate commenced. Both the Pay Station System and Pay-By-Phone System were updated with the new parking rate for off-street parking. • Notifications of the parking rate change were hand-delivered to Surfside businesses on 07-24-2018. • Email notification of the parking rate change was sent out on 07-25-2018. • Notification of the parking rate change was posted on the Town website on 07-25-2018. • On 07-25-2018, the Town website “Parking” section was reviewed and the areas requiring the new rate change were updated by CGA (Adrian). <p>New Parking rate decals were received and they were affixed to the Parking Pay Stations in the Municipal Parking Lots on 08-22-2018.</p> <p>At the June 20, 2019, meeting of the Downtown Vision Advisory Committee (DVAC), the Committee formalized recommendations for the Town Commission to consider regarding changing the Off-Street Parking Rates. At the July 9, 2019, Town Commission Meeting the Town Commission discussed and approved parking rate changes for all Town Off-Street Parking (Municipal Parking Lots) as follows:</p> <ul style="list-style-type: none"> • Weekends/Holidays: <ul style="list-style-type: none"> ○ 9:00 AM - 5:00 PM
--	--	---

			<ul style="list-style-type: none"> ○ \$3.00/hour with a 4-hour limit that is not renewable ○ 5:00 PM – 9:00 AM \$2.00/hour with a 4-hour limit that is renewable ● Weekdays: <ul style="list-style-type: none"> ○ 9:00 AM - 5:00 PM \$2.00/hour with a 4-hour limit that is not renewable ○ 5:00 PM – 9:00 AM \$2.00/hour with a 4-hour limit that is renewable <p>For the August 13, 2019, Town Commission Meeting the Police Department submitted a memorandum for Approval to Modify the Parking Rate and Parking Time Limits for Off-Street Parking (Municipal Parking Lots) through Town Resolution.</p> <p>At the August 13, 2019, Town Commission meeting the Commission approved the Off-Street (Municipal Parking Lots) Modifications to the Parking Rates and Parking Time Limits as previously described. Notifications regarding the new rates and time limits were posted on the Town website and were sent out on social media. Effective August 19, 2019, the new Off-Street Parking Rates and Parking Time Limits commenced.</p>
<p>5.</p>	<p>Variable Parking Rate for On-Street Parking Spaces in the Business District (9400 and 9500 blocks of Harding Avenue)</p>	<p>Closed</p>	<p>At the 03-12-19, Town Commission meeting the Town Commission approved the following changes to a staff recommendation to initiate a Variable Parking Rate for On-Street Parking Spaces in the Business District (9400 and 9500 blocks of Harding Avenue). The Variable Parking Rate will be as follows: Weekdays (Mon-Fri) only between 10:00 AM – 4:00 PM will be \$4.00/hour with a 2-hour limit (after the expiration of 2 hours the parking space is not renewable between the hours of 10:00 AM – 4:00 PM and the vehicle will not be permitted to park in an On-Street parking space in the Business District until after 4:00PM).</p> <p>The Town Commission requested a review be conducted regarding the effects of the On-Street Variable-Rate in the Business District, and the review be submitted two months after the rate change implementation date. The resolution will be</p>

			<p>voted on at the Town Commission Meeting on 04-09-19.</p> <p>The resolution was approved by the Town Commission and on Monday 04-15-2019, the Variable Parking Rate was implemented without issue for the Parking Pay Stations and Pay-By-Phone Systems. A two-month evaluation of the program will be submitted in June 2019.</p> <p>On June 18, 2019, the Police Department submitted the two-month evaluation report for the Business District Variable Parking Rate change. The report was available to the Town Commission for review. At the July 9, 2019 Commission Meeting the Business District Variable Parking Rate change was approved on a permanent basis.</p>
6.	Taxi Cab Stands added and changed	Closed	<ul style="list-style-type: none"> • The Taxi Cab Stand at 94th Street & Collins Avenue was reduced from (4) vehicles to (2) vehicles. • 94th Street & Harding Avenue (across from Publix) will have a (2) vehicle Taxi Cab Stand. *One metered parking space has been added. • In the 200 block of 92nd Street (North side in front of the Marriott) one metered parking space was removed and replaced with a (1) vehicle Taxi Cab Stand. • A (2) vehicle Taxi Cab Stand has been added to the south side of the 200 block of Collins Avenue. <p>On 11-15-17, Chief Allen met with the management of the Azure Condominium regarding the taxi stand at 94th Street and Collins Avenue. They had no complaints regarding the location of the stand and were not aware of complaints or traffic concerns from residents of the condo. The taxis crossing Collins Avenue do not interfere with the exiting of cars from their building. The manager was happy that the stand was reduced from four to two taxis.</p> <p>One person has voiced opposition with the location of the taxi stand being across the street because it is unsightly and wants it moved.</p>

			Chief Allen next met with the valet manager of the Grand Beach Hotel who said the two taxi stand is working out well and when a taxi is needed they signal for one from the stand. Chief Allen also met with the General Manager of the hotel regarding the concern and asked for one space for a taxi on the hotel property. The GM agreed. The space is just inside the garage and is now opened for taxi use.
7.	2018 Parking Permits for the 9400 and 9500 blocks of Byron Avenue	Closed	The 2018 Byron Avenue Parking Permits are only for residents and their guests on the 9400 & 9500 blocks of Byron Avenue. The application and the registration process instructions were included in the December 2017 Surfside Gazette. Residents must provide proof of residency and may obtain up to 3 permits per household. Only residents and their guests may park in these areas with the proper permit all other vehicles are subject to being issued a parking citation.
8.	Replacement of No Parking Signs and additional No Parking Signs 9400 block of Abbott Avenue	Closed	Based on Police Department observations the replacement of No Parking Signs that are in poor condition, and additional No Parking Signs will be installed in the 9400 block of Abbott Avenue. Public Works is working in conjunction with the Parking Department to complete this project. The signs were received and installed the week of February 25, 2019.

Respectfully submitted by:

Guillermo Olmedillo, Town Manager

Between Jun 01, 2020 and Jun 30, 2020

34 requests were opened

29 requests were closed

The average time to close was 2.6 days.

REQUEST CATEGORY	OPENED	CLOSED	DAYS TO CLOSE
Other	11	10	2.4
Beach Issue	10	9	2.6
Street lights (PW)	4	3	3.4
Police (Safety Concern)	2	2	0.9
Code Compliance (Violation)	2	1	1.8
Parking Issue	1	1	0.0
Code Compliance (Safety Concern)	1	1	4.3
Dead Animal	1	1	1.3
Utilities (Water/Sewer) (PW)	1	1	7.3
Construction Issues	1	0	0.0
96 Street Park (P & R)	0	0	0.0
Barking Dog	0	0	0.0
Beach Patrol	0	0	0.0
Community Center (P & R)	0	0	0.0
Dog Stations (P & R)	0	0	0.0
Drainage/Flooding (PW)	0	0	0.0
Graffiti (in park) (P & R)	0	0	0.0
Graffiti (PW)	0	0	0.0
Hawthorne Tot-Lot (P & R)	0	0	0.0
Pothole (PW)	0	0	0.0
Solid Waste (Commercial) (PW)	0	0	0.0
Solid Waste (Residential) (PW)	0	0	0.0
Surfside Dog Park (P & R)	0	0	0.0
Veterans Park (P & R)	0	0	0.0

Town of Surfside, FL

Between Jan 01, 2014 and Jun 30, 2020

1220 requests were opened

1192 requests were closed

The average time to close was 24.3 days.

REQUEST CATEGORY	OPENED	CLOSED	DAYS TO CLOSE
Other	268	266	23.0
Beach Issue	213	202	20.2
Code Compliance (Violation)	156	155	27.6
Parking Issue	103	103	3.2
Police (Safety Concern)	84	84	8.8
Code Compliance (Safety Concern)	97	97	29.9
Street lights (PW)	61	59	119.8
Utilities (Water/Sewer) (PW)	42	35	11.1
Construction Issues	41	40	15.3
Drainage/Flooding (PW)	37	34	24.9
Solid Waste (Residential) (PW)	27	27	21.1
Dog Stations (P & R)	15	15	4.7
Barking Dog	12	12	20.0
96 Street Park (P & R)	11	11	2.9
Community Center (P & R)	11	10	11.6
Surfside Dog Park (P & R)	9	9	1.3
Solid Waste (Commercial) (PW)	7	7	7.3
Hawthorne Tot-Lot (P & R)	7	7	33.6
Pothole (PW)	6	6	27.2
Beach Patrol	5	5	3.1
Dead Animal	5	5	12.9
Graffiti (PW)	3	3	25.2
Graffiti (in park) (P & R)	0	0	0.0
Veterans Park (P & R)	0	0	0.0



MEMORANDUM

To: Guillermo Olmedillo, Town Manager

From: Rachel Pinzur, Public Information Representative

Date: June 24, 2020

Subject: June Social Media (Nextdoor) Report

As part of the Town's communication strategy, the Public Information Representative (PIR) uses Nextdoor to provide residents with helpful information especially amid the coronavirus crisis and to further direct strategy based on matters that are important to residents. Nextdoor is only one of several communication channels used to reach residents including the Town's at-risk seniors and most vulnerable communities.

During the month of June, the PIR continued to publish posts pertaining to the COVID-19 pandemic and also encouraged residents to prepare and plan ahead for hurricane season. With social distancing requirements, it is important for residents to have evacuation plans in place in the event of a mandatory evacuation. Residents can find valuable COVID-19 updates and hurricane preparedness information on the Town website.

The Town of Surfside remains committed to staying on top of the most up-to-date information in order to make informed decisions to help safeguard the Surfside community. As the situation is changing rapidly, the Town provides regular updates as new information emerges.

It is important to reiterate the Nextdoor platform is not a replica of the Town's website and Gazette and should not be viewed as such. To that end, information presented on Nextdoor often refers back to the Town's primary communication tools. The Town encourages residents to find information on the Town's website (www.townofsurfsidefl.gov) and/or by contacting the Town directly.

Last updated on 6/26/2020

DEVELOPMENT APPLICATION PROCESS (2009 - PRESENT)													
Application Date	Location	Project Description	Zoning Process			Density/Intensity		Variances		Building Permit			Construction Status
			DRG	P&Z	TC	Allowed	Approved	Requested	Received	Application No.	Issuance	Status	
12/29/2009	9200 Collins Ave	Surfside Hotel - Proposed surfside hotel consisting of 183 hotel units, 4 stories and adjacent 3 stories garage	1/13/2010, 2/3/2010	2/25/2010	5/10/2011	242 units	175 units	None	None	13-377	1/13/2014	Issued	Completed
1/6/2010	9580 Abbott Ave	Young Israel - Construction of Jewish orthodox temple containing 371 seats and a maximum building height of 40 feet	1/20/2010, 2/2/2012	3/29/2012	4/10/2012	Negotiated settlement to determine buildable area and setbacks		Approved through Settlement agreement not variance. Settlement determined setbacks.		13-118	5/5/2014	Issued	Completed
5/4/2011	9449 & 9418 Collins Ave	Grand Beach-341 room hotel	5/18/2011, 6/15/2011	7/28/2011	9/13/2011	341 units	341 units	None	None	12-144	5/5/2012	Issued	Completed
7/17/2012	9379, 9365 & 9349 Collins Ave	Chateau Ocean Residences - Demolition of existing 92-room hotel; construction of 90-unit residential condominium building and accessory amenities	8/12/2012, 9/11/2012	12/4/2012	1/24/2013	325 units	85 units (however approximately 58 were built)	None	None	14-132	9/24/2014	Issued	Completed
Original submittal: 7/13/2012 Site plan amendment: 4/16/16	9011 Collins Ave	Surf Club - restoration of the famous surf club historic structure and for the construction of new improvements	7/31/2012, 8/23/2012, site plan amendment: 5/16/2016, 8/4/2016, 3/9/2017, 5/11/2017	9/27/2012, site plan amendment: 8/31/2017	Original site plan: 10/15/2012, site plan amendment: 10/10/2017	762 units	257 units	None	None	13-727	6/27/2014	Issued	Under Construction
7/20/2012	9450 Collins Ave	The Shul - New multiuse glass atrium and joining learning center (3 stories)	2/11/2013, 3/27/2013, 7/9/2013	2/27/2014	10/29/2014	3 story expansion of 8,558.9 square feet		None	None	14-509	11/12/2015	Issued	Under Construction
3/15/2015	201, 203, 205, 207, 209 & 215 88th St 8809 Harding Ave	Surfside Condo's - redevelopment of 77 parcels into single unified condo development	4/2/2015, 6/3/2015	8/27/2015	12/8/2015	65 units	28 units	None	None	16-569		Plans approved, waiting on GC	Pending selection of GC
8/12/2015	9133 Collins Ave & 9149 Collins Ave	Surf Club II - Redevelopment of property with a multi-family residential project and renovation of existing historic structure	9/4/2015, 9/9/2017, 9/17/2017	12/7/2017	2/13/2018	199 units	48 condominium units, 31 hotel rooms	None	None			Has not applied for permit yet. Applicant has requested extension of approval at 7/14/2017 TC meeting.	
Original submittal: 2/11/2016 Revised submittal: 5/31/18	9380, 9372, 9364, 9348, 9340, 9322, 9316 & 9300 Collins Ave	9300 Collins Ave - demolition of all existing improvements, construction of 3-story building	Original submittal: 3/10/2016, 4/27/2016 Revised submittal: 6/27/2018, 8/28/2018, 11/1/18	Original approval: 7/18/2016, Revised approval: 11/29/18	Original approval: 11/10/2016, current site plan has not been approved yet. Scheduled for February 26, 2019	250 units	Request is for 205 units	None	None	18-610		Has not applied for permit yet	
5/4/2016	8955 Collins Ave	Residential Condominiums	6/20/2016, 7/27/2016	10/27/2016	11/10/2016	110 units	16 units	None	None	16-602	12/26/2017	Issued	Under Construction
Oct-16	9116 Harding Ave	303 Surfside - 4 Townhouses	11/2/2016, 2/7/2017, 5/18/2017	6/27/2018	4/14/2018	8 units	4 units	None	None			Has not applied for permit yet	
5/19/2017	8995 Collins Ave	Surf House - site plan approval for expansion to existing multi-family building	6/19/2017, 8/24/2017, 9/28/2017	2/22/2018, 4/26/2018, 5/31/2018, approved on 10/27/19	Scheduled for 12/10/19	99 units	Current request has not been scheduled for commission yet. Request is for 34 units	3 requested: 1. Section 90-82. - Off-street loading requirements (Loading Space Size). 2. Section 90-91.2. - Required landscaping adjacent to streets and abutting properties (Landscape Buffer). 3. Section 90-93(1b) - Open Space (Open Space Trees).	Has not been scheduled for TC until recommendation from PZ			Has not applied for permit yet	
Original submittal: 10/26/2017	Abbott Lot	Unsolicited Proposal (P3)											Terminated
Original Submittal: 1/06/2015 Revised submittals: 8/01/2016, 12/23/2016, 03/09/2018, 10/29/2018	8851 Harding Avenue	18 multi-family units	01/22/2015, 08/18/2016, 01/23/2017, 03/23/2018, 11/29/2018	01/31/19 PZ recommended approval	Denied by the Commission	33 units	Request is for 18 units	1 requested: Section 90-82. - Off-street loading requirements (Loading Space Size).	Approved				Denied
7/3/2019	9580 Abbott Ave	Young Israel Variance Request to eliminate landscaping to provide for a handicapped accessible ramp	N/A	8/29/2019	10/29/19			1 requested: eliminate landscaping along the north side of the building	Approved				
1/7/2020	9340 Collins Avenue	Eden request to demolish and rebuild historic structure.	N/A	Deferred 1/30/20	Applicant withdrew the site plan				Withdrawn				Withdrawn by the applicant
1/7/2020	8926 Collins Avenue	Arte request to have FFL vault encroach into landscape buffer.	N/A	1/30/2020	2/11/2020			Landscape buffer	Approved				

TOWN OF SURFSIDE, FLORIDA
MONTHLY BUDGET TO ACTUAL SUMMARY

FISCAL YEAR 2020

As of MAY 31, 2020

67% OF YEAR EXPIRED (BENCHMARK)

Agenda Item #

Page

1 of 3

July 14, 2020

GOVERNMENTAL FUNDS	ACTUAL	ANNUAL BUDGET	% BUDGET
--------------------	--------	---------------	----------

GENERAL FUND - 001

REVENUE	\$ 15,101,190	\$16,549,272	91%
EXPENDITURES	8,230,147	\$16,549,272	50%
Net Change in Fund Balance	6,871,043		
Fund Balance-September 30, 2019 (Unaudited)	14,983,070 ^A		
Fund Balance-May 31, 2020 (Reserves)	\$ 21,854,113		

TOURIST RESORT FUND - 102

REVENUE	\$ 2,234,442	\$3,308,050	68%
EXPENDITURES	1,483,661	\$3,308,050	45%
Net Change in Fund Balance	750,781		
Fund Balance-September 30, 2019 (Unaudited)	1,640,525		
Fund Balance-May 31, 2020 (Reserves)	\$ 2,391,306		

POLICE FORFEITURE FUND - 105

REVENUE	\$ 13,671	\$101,300	13%
EXPENDITURES	72,274	\$101,300	71%
Net Change in Fund Balance	\$ (58,603)		
Fund Balance-September 30, 2019 (Unaudited)	105,725		
Fund Balance-May 31, 2020 (Reserves)	\$ 47,122		

TRANSPORTATION SURTAX FUND - 107

REVENUE	\$ 140,185	\$276,000	51%
EXPENDITURES	224,817	\$276,000	81%
Net Change in Fund Balance	(84,632)		
Fund Balance-September 30, 2019 (Unaudited)	328,377		
Fund Balance-May 31, 2020 (Reserves)	\$ 243,745		

BUILDING FUND - 150

REVENUE	\$ 359,995	\$1,517,713	24%
EXPENDITURES	874,453	\$1,517,713	58%
Net Change in Fund Balance	(514,458)		
Fund Balance-September 30, 2019 (Unaudited)	2,563,518		
Fund Balance-May 31, 2020 (Reserves)	\$ 2,049,060		

CAPITAL PROJECTS FUND - 301

REVENUE	\$ 176,003	\$250,000	70%
EXPENDITURES	108,301	\$250,000	43%
Net Change in Fund Balance	67,702		
Fund Balance-September 30, 2019 (Unaudited)	3,048,583		
Fund Balance-May 31, 2020 (Reserves)	\$ 3,116,285		

NOTES:

* Many revenues for May 2020 are received in subsequent months (timing difference) and are recorded on a cash basis in the month received.

A. Includes \$2,000,000 available for hurricane/emergencies. The balance of \$12,983,070 is unassigned fund balance (reserves).

PROPRIETARY FUNDS	ACTUAL	ANNUAL BUDGET	% BUDGET
-------------------	--------	---------------	----------

WATER & SEWER FUND - 401

REVENUE	\$ 1,627,622	\$4,424,500	37%
EXPENDITURES	1,571,763	\$4,424,500	36%
Change in Net Position	55,859		
Unrestricted Net Position-September 30, 2019	(2,367,098)		
Unrestricted Net Position-May 31, 2020 (Reserves)	\$ (2,311,239)		

MUNICIPAL PARKING FUND - 402

REVENUE	\$ 783,090	\$1,333,618	59%
EXPENDITURES	834,980	\$1,333,618	63%
Change in Net Position	(51,890)		
Unrestricted Net Position-September 30, 2019	1,198,948		
Unrestricted Net Position-May 31, 2020 (Reserves)	\$ 1,147,058		

SOLID WASTE FUND - 403

REVENUE	\$ 1,072,500	\$2,132,673	50%
EXPENDITURES	1,312,284	\$2,132,673	62%
Change in Net Position	(239,784)		
Unrestricted Net Position-September 30, 2019	641,636		
Unrestricted Net Position-May 31, 2020 (Reserves)	\$ 401,852		

STORMWATER FUND - 404

REVENUE	\$ 409,916	\$1,034,704	40%
EXPENDITURES	440,284	\$1,034,704	43%
Change in Net Position	(30,368)		
Unrestricted Net Position-September 30, 2019	3,200,132		
Unrestricted Net Position-May 31, 2020 (Reserves)	\$ 3,169,764		

FLEET MANAGEMENT FUND - 501

REVENUE	\$ 636,568	\$987,346	64%
EXPENDITURES	700,435	\$987,346	71%
Change in Net Position	(63,867)		
Unrestricted Net Position-September 30, 2019	585,363		
Unrestricted Net Position-May 31, 2020 (Reserves)	\$ 521,496		



Jason D. Greene, Finance Director



Guillermo Olmedillo, Town Manager

Town of Surfside
Net Funds Historical Balances
Period 2016 - May 2020

FUND	9/30/2016	9/30/2017	9/30/2018	9/30/2019	5/31/2020	CAGR ^(a)
General	\$ 7,368,408	\$ 8,460,802	\$ 10,902,050	\$ 14,983,070	\$ 21,854,113	26.7%
Tourist Resort	363,407	469,880	356,313	1,640,525	2,391,306	65.3%
Police Forfeiture	141,755	164,933	159,527	105,725	47,122	-9.3%
Transportation Surtax	354,264	388,363	263,292	328,377	243,745	-2.5%
Building	-	1,742,910	2,760,673	2,563,518	2,049,060	-3.6%
Capital Projects	1,154,352	576,122	2,158,902	3,048,583	3,116,285	38.2%
Water & Sewer	(2,827,890)	(3,048,579)	(2,546,398)	(2,367,098)	(2,311,239)	-5.8%
Municipal Parking	1,111,941	811,013	943,315	1,198,948	1,147,058	2.5%
Solid Waste	245,941	429,743	601,201	641,636	401,852	37.7%
Stormwater	3,392,370	3,264,379	3,203,878	3,200,132	3,169,764	-1.9%
Fleet Management	-	-	-	585,363	521,496	N/A
Total	\$ 11,304,548	\$ 13,259,566	\$ 18,802,753	\$ 25,928,779	\$ 32,630,562	30.3%

(a) - CAGR stands for Compound Average Growth Rate, and is a useful measure of growth over multiple time periods. It represents the growth rate of a Fund Balance from the initial time value to the ending balance if you assume that the fund has been compounding over a time period.



Item 3C

TOWN OF SURFSIDE
Office of the Town Attorney
MUNICIPAL BUILDING
9293 HARDING AVENUE
SURFSIDE, FLORIDA 33154-3009
Telephone (305) 993-1065

TO: Mayor and Town Commission

FROM: Lillian M. Arango, Town Attorney
Weiss Serota Helfman Cole & Bierman, P.L.

CC: Guillermo Olmedillo, Town Manager
Jason Greene, Interim Assistant Town Manager

DATE: July 7, 2020

SUBJECT: Office of the Town Attorney Report for July 14, 2020

This Office attended/prepared and/or rendered advice for the following Public Meetings and Commission meetings:

June 3, 2020 - Virtual Zoning Workshop

June 9, 2020 – Virtual Regular Town Commission Meeting

June 18, 2020 - Virtual Budget Workshop Meeting

June 23, 2020 - Virtual Special Town Commission Meeting

July 1, 2020 - Virtual Special Town Commission Meeting, Appointment of Boards and Committees

July 6, 2020 - Joint Special Town Commission and Pension Board Meeting

Members of the firm assisted with the agendas and drafted the resolutions and ordinances for these meetings in addition to drafting or assisting with the preparation of a number of the communications and reviewing, revising and, as appropriate, negotiating the legal requirements

of the relative agreements and supporting documents. Members of the firm were instrumental in contacting Governor DeSantis early in the COVID-19 pandemic to seek approval by Emergency Order 20-69 for virtual commission meetings to ensure that the Town Commission could continue meeting and conducting essential Town business and implementing policy. The Firm assisted with the preparation and adoption of rules governing virtual meeting or communications media technology for public meetings during the COVID-19 health emergency, as required by Governor DeSantis' Executive Order 20-69, "Emergency Management - COVID-19 Local Government Public Meetings." The Firm has also assisted the Town with the preparation of various emergency measures or orders due to the COVID-19 health pandemic.

Commission Support:

Attorneys of the firm have worked with members of the newly elected Town Commission to transition and address concerns and research specific issues and are always available, either in the office or by phone or email. The COVID-19 health pandemic has created additional challenges, and inhibited our ability to personally meet with members of the Town Commission. We appreciate your support as we transition and continue our third year of service and work in implementing new policy directives.

Staff Support:

Members of the firm have provided extensive support to Town administration and staff during the recent COVID-19 health pandemic, and addressed a variety of issues and assisted with the Town's response to the crisis.

As typical, members of the Firm continue to assist the Town administration and staff, as well boards and committees, with application review, contract and agreement review, procurement and purchasing, budgetary requirements and approval process, various solicitations and agreements, IT related agreements, ADA compliance agreements, Code enforcement and interpretation, attendance at Special Master Hearings, beach furniture operator permits and administration, police related issues and matters, review and preparation of RFP for design/build of photovoltaic system for Community Center and RFQ for design of 96th Street Park, vehicle purchases for Town Departments, building permit and enforcement issues, subpoenas and public records requests, research, litigation support, oversight and case management, Town Code

interpretation and application, labor, employee and pension matters, and various procurements and service provider contracts for Town Departments.

Key Issues:

The workload has been diverse and has included specific issue support to every department. Key issues over the past year have included:

- Code of Ethics and Lobbying Code
- Roof Height Ordinance
- Freeboard Ordinance
- Sign Code Amendment Ordinance
- Amendments to the Town's Purchasing Code and Cone of Silence
- Anti-Semitic Ordinance
- Pension Board Ordinance
- Tree Planting and Mulch In the Public Right Away Ordinance
- Ethics Ordinance
- Driveway Modifications
- Ordinance Banning Plastic Straws and Resolution Establishing Fees/Fines for Violations
- Solar Panel Permitting Ordinance and Resolution Providing for Waiver of Fees and Expediting of Permit Process
- Ordinance Lifting Prohibition on Surfboards
- Ordinance on Building Lengths and Building Separations
- Ordinance Revising Development Application Procedures
- Ordinance on Marine Turtle Lighting
- Ordinance on Development Approvals Procedures
- Ordinance on Cone of Silence Procurement Process
- Sensible Gun Reform Resolution
- Plastic Bag Ban Legislation and Analysis
- Tourist Board Agreements and Procurement

- Public Records and Subpoena Requests for Documents
- Sustainability Initiatives and Legislation
- Firearm Preemption Lawsuit
- Beach Furniture Ordinance and Regulations
- Comprehensive Plan Amendments
- Solid Waste Service Assessment Ordinance, and accompany Preliminary and Final Rate Resolutions
- PACE District Agreements
- Aggregation of Single Family Lots Ordinance
- DIC/DRG/DRB Procedures Ordinance
- Building Length Ordinance & Grandfathering Amendments
- Beach Re-nourishment
- Recycling Agreement
- Agreement for Landscape Maintenance Services
- Agreement for Concession Services at the Community Center
- Agreement for Tourist Board Marketing Services
- Ordinance for Reasonable Accommodations Procedures
- Ordinance Amending Secondary Frontage Fence and Ornamental Wall Regulations
- Ordinance Amending Plastic Straw Ban Ordinance
- Ordinance Corner Lot Fencing
- Ordinance Amending Ethics Code to Require Disclosure of Business Relationships
- Ordinance on Hotels in H40 District
- Ordinance Banning the Sale and Distribution of Sunscreens Containing Oxybenzone and/or Octinoxate
- Request for Proposals (RFP) for Downtown LED Lighting
- Florida Friendly Landscape and Fertilizer Ordinance
- State of Florida Model Flood Ordinance
- Parking Waiver Ordinance (and Extension) for Business District
- Ordinance Regulating Single-Use Plastics and Repeal of Ordinance
- Ordinance Regulating Hurricane Shutters
- Ordinance Regarding Waiver of Lobbyist Registration Fees for Town Businesses.

- Ordinance Amending Qualifying Dates for March 17, 2020 Election
- Ordinance Restricting Hotel Accessory Uses in H40 District South of 93 Street
- Resolution and Preparation of Adoption of Travel, Transportation and Meal Policy for Town Officials and Employees
- Resolutions Adopting Proposed 2019/2020 Millage Rate and Budget
- Regulation of Herbicides/Glyphosate
- Ordinance Establishing Limitations for Hotels in the H40 District South of 93 Street
- Renewal/Amendment of Post Office Lease with USPS
- Ordinance on Residential Setbacks
- Text Messaging Policy for Town Employees
- Resolution Declaring Climate Crisis
- Resolution Adopting Climate Crisis Report
- Ordinance Amending Purchasing Code
- Ordinance on Artificial Turf
- Ordinance Repealing Aggregated Setbacks
- Emergency Declaration and Emergency Measures and Orders related to the COVID-19 health pandemic.
- Contract Review Related to COVID-19 health pandemic.
- Resolution Establishing Budget Committee
- Resolution On Parks and Recreation Committee
- Resolution Revising Down Vision Advisory Committee (DVAC) Charter
- Resolution Revising Resiliency Reserve Fund Policy
- Repeal of Ch 90 Zoning Code and Map and Adoption of New Zoning Code
- Ordinance Revising Planning & Zoning Board Membership to Add Resiliency Member
- Ordinance Revising Resort Tax Board Membership to Add Resiliency Member
- Resolution Combatting Hate Due to COVID-19 Health Pandemic
- Resolutions Approving Interlocal Agreements with Miami-Dade County for Access to Exempt Information and Enforcement of Miami-Dade County Code
- Resolution for the Purchase of Police Body-Worn Cameras and Preparation of Agreement
- Resolution Re Nurse Initiative Ruth K. Broad

- Beach Furniture Ordinance
- Preliminary Rate Resolution Solid Waste Assessment
- RFQs for Abbott Avenue Drainage, Planning Services and Engineering Services
- Resolution Calling Special Election and Referendum for Undergrounding of Utilities

Litigation: New or supplemental information is provided for the following case:

No report at this time. Information on pending litigation has or will be provided individually to members of the Town Commission, as needed.

Special Matters: Continued monitoring of new case law and legislation from Federal, State and County, including implementation of adopted House and Senate Bills for the 2020 Florida Legislative Session. Matters which we will continue to work on and anticipate in the upcoming months include, implementation of various policy directives from newly elected Mayor and Town Commissioners, orientation and training of newly elected Commissioners related to Sunshine Law, Public Records Law and Ethics, issues related to the COVID-19 health pandemic, including issuance and implementation of various emergency orders and measures, review of existing contracts for services related to the COVID-19 pandemic, review of utility/franchise agreements and address existing telecommunication facilities in the Town's rights-of-way, revised or replacement beach furniture ordinance, short term rentals ordinance, review of revenue utility bonds and reduction of water/sewer rates, review and analysis of Resort Tax and Tourist Board legislation, procurement of professional services and contracts, FAA revised NextGen flights paths, review and policy implementation of revisions to Zoning Code and Map, review and monitoring of all Development Orders and approvals, police matters and agreements, stormwater utility fees' methodology and collection, re-imposition of solid waste assessment by initial and final rate resolutions, RFQs for Planning Services, Engineering Services and Abbott Avenue Drainage project, address referendum and charter amendments, various procurements and service or provider agreements for Town improvements, facilities and programs, and FY 2020/2021 budget preparation and approval.



MEMORANDUM

ITEM NO. 3E

To: Honorable Mayor, Vice-Mayor and Members of the Town Commission

From: Guillermo Olmedillo, Town Manager

Date: July 14th, 2020

Subject: Resolution authorizing Mutual Aid Agreement between Bal Harbour Village and Town of Surfside.

It is the responsibility of the governments of the Town of Surfside, Florida, and the Bal Harbour Village, Florida, to ensure the public safety of their citizens by providing adequate police service to address any foreseeable routine or emergency situation; and because of the existing and continuing possibility of the occurrence of law enforcement problems and other natural or manmade conditions which are likely to be, beyond the control of the services, personnel, equipment or facilities of the participating police departments; these municipalities have the authority to enter into a Mutual Aid Agreement in order to adequately address any and all of these conditions, to protect the public peace and safety, and to preserve the lives and property of the people of the municipalities. The Mutual Aid Agreement specifies the circumstances and conditions under which mutual aid may be requested and rendered regarding police operations.

The Town of Surfside Police Department has mutual aid agreements with many Miami-Dade County law enforcement agencies and the Bal Harbour Village Police Department has been one of them for years. The Town of Surfside and the Bal Harbour Village are located in a way that it is advantageous and in their best interest to receive and extend mutual aid in the form of law enforcement services and resources.

The new Mutual Aid Agreement between the Bal Harbour Village Police Department and the Town of Surfside Police Department shall take effect retroactively from January 1, 2020 upon execution and approval by both parties and shall continue in full force and effect until December 31, 2024. Under no circumstances may this agreement be renewed, amended, or extended except in writing. The Surfside Police Department requires approval and authorization to enter into the new Mutual Aid Agreement at the request of the Bal Harbour Village Police Department.

Staff recommends a motion to approve a resolution authorizing the Mutual Aid Agreement between the Bal Harbour Village, Florida, and the Town of Surfside, Florida.

Prepared by: Chief Julio Yero

RESOLUTION NO. 2020-_____

A RESOLUTION OF THE TOWN COMMISSION OF THE TOWN OF SURFSIDE, FLORIDA, APPROVING A VOLUNTARY COOPERATION AND OPERATIONAL ASSISTANCE MUTUAL AID AGREEMENT WITH THE BAL HARBOUR VILLAGE, FLORIDA; PROVIDING FOR AUTHORIZATION; PROVIDING FOR IMPLEMENTATION; AND PROVIDING FOR AN EFFECTIVE DATE.

WHEREAS, the Town of Surfside (the “Town”) has historically entered into mutual aid agreements with other municipalities for the purpose of providing voluntary cooperation and assistance of a routine law enforcement nature across jurisdictional lines; and

WHEREAS, the Town and the Bal Harbour Village, Florida wish to enter into a Voluntary Cooperation and Operational Assistance Mutual Aid Agreement, in the form attached hereto as Exhibit “A” (the “Agreement”); and

WHEREAS, the Town Commission wishes to approve the Agreement and authorize the Town Manager and Chief of Police to execute the Agreement approved by this Resolution; and

WHEREAS, the Town Commission finds that the Agreement and this Resolution is in the best interest and welfare of the Town.

NOW, THEREFORE, BE IT RESOLVED BY THE TOWN COMMISSION OF THE TOWN OF SURFSIDE, FLORIDA, AS FOLLOWS:

Section 1. **Recitals.** The above-stated recitals are true and correct and are incorporated herein by this reference.

Section 2. **Approval.** That the Town Commission approves the Agreement in substantially the form attached hereto as Exhibit “A.”

Section 3. **Authorization.** That the Town Manager and Chief of Police are hereby authorized to execute the Agreement in substantially the form attached hereto as Exhibit “A.”

Section 4. **Implementation.** The Town Manager, Chief of Police and/or designee are authorized to take any and all action necessary to implement the purposes of this Resolution and the Agreement.

Section 5. **Effective Date.** This Resolution shall become effective immediately upon adoption.

PASSED AND ADOPTED on this -- **the day of June, 2020.**

Moved By: _____
Second By: _____

FINAL VOTE ON ADOPTION

Commissioner Nelly Velasquez _____
Commissioner Eliana R. Salzhauer _____
Commissioner Charles Kesl _____
Vice Mayor Tina Paul _____
Mayor Charles W. Burkett _____

Charles W. Burkett
Mayor

ATTEST:

Sandra Novoa, MMC
Town Clerk

**APPROVED AS TO FORM AND LEGALITY FOR THE USE
AND BENEFIT OF THE TOWN OF SURFSIDE ONLY:**

Weiss Serota Helfman Cole & Bierman, P.L.
Town Attorney

**COMBINED VOLUNTARY COOPERATION AND
OPERATIONAL ASSISTANCE
MUTUAL AID AGREEMENT
BETWEEN
BAL HARBOUR VILLAGE, FLORIDA AND
THE TOWN OF SURFSIDE, FLORIDA**

This Voluntary Cooperation and Operational Assistance Mutual Aid Agreement (the "Agreement") is made as of this ____ day of _____, 2020, by and between the BAL HARBOUR VILLAGE, FLORIDA, a Florida municipal corporation, having its principal office at 655 96 Street, Bal Harbour Village, FL 33154, and the TOWN OF SURFSIDE, FLORIDA, a Florida municipal corporation having its principal office at 9293 Harding Ave., Surfside, FL 33154, and states as follows:

WHEREAS, it is the responsibility of the governments of Bal Harbour Village, Florida, and the Town of Surfside, Florida, to ensure the public safety of their citizens by providing adequate levels of police services to address any foreseeable routine or emergency situation; and

WHEREAS, there is an existing and continuing possibility of the occurrence of law enforcement problems and other natural and man-made conditions which are, or are likely to be, beyond the control of the services, personnel, equipment, or facilities of Bal Harbour Village Police Department or the Town of Surfside Police Department; and

WHEREAS, Bal Harbour Village and the Town of Surfside are so located in relation to each other that it is in the best interest and advantage of each to receive and extend mutual aid in the form of law enforcement services and resources to adequately respond to:

- (1) Continuing, multi-jurisdictional criminal activity, so as to protect the public peace and safety, and preserve the lives and property of the people; and
- (2) Intensive situations including, but not limited to, natural or manmade disasters or emergencies as defined under Section 252.34, Florida Statutes; and
- (3) Joint provision of certain law enforcement services specified herein and allowed pursuant to Florida Statute 166.0495; and

WHEREAS, Bal Harbour Village and the Town of Surfside have the authority under The Mutual Aid Act, Chapter 23, Part I, Florida Statutes, to enter into a combined mutual aid agreement for law enforcement services which:

- (1) Permits voluntary cooperation and assistance of a routine law enforcement nature across jurisdictional lines; and
- (2) Provides for rendering of assistance in a law enforcement emergency.

NOW, THEREFORE, BE IT KNOWN, that Bal Harbour Village, a political subdivision of the State of Florida, and the Town of Surfside, a political subdivision of the State of Florida, in consideration for mutual promises to render valuable aid in times of necessity, do hereby agree to fully and faithfully abide by and be bound by the following terms and conditions.

SECTION 1: PROVISIONS FOR VOLUNTARY COOPERATION

Each of the aforesaid law enforcement agencies hereby approve and enter into this Agreement whereby each of the agencies may provide voluntary cooperation and assistance of a routine law enforcement nature across jurisdictional lines. The nature of the law enforcement assistance to be rendered shall include but not be limited to:

- a. Concurrent law enforcement jurisdiction in and throughout the territorial limits of Bal Harbour Village and the Town of Surfside for arrests, made pursuant to the laws of arrest, for felonies and misdemeanors, including arrestable traffic offenses, which spontaneously take place in the presence of the arresting officer, at such times as the arresting officer is traveling from place to place on official business outside of his or her jurisdiction, for example, to or from court, or at any time when the officer is within the territorial limits of his or her jurisdiction.
- b. Concurrent law enforcement jurisdiction in and throughout the territorial limits of Bal Harbour Village and the Town of Surfside for arrests, made pursuant to the laws of arrest, of persons identified as a result of investigations of any offense constituting a felony or any act of Domestic Violence as defined in Section 741.28, Florida Statutes, when such offense occurred in the municipality employing the arresting officer.
- c. Concurrent law enforcement jurisdiction in and upon the jurisdictional waters of Bal Harbour Village and the Town of Surfside for arrests, made pursuant to the laws of arrest, for felonies and misdemeanors and boating infractions.

- d. Participating in exigent situations, without the need for a formal request, including, but not limited to, area searches for wanted subjects, perimeters, crimes in progress, escaped prisoners, traffic stops near municipal boundaries, requests for assistance when no available local units are nearby, calls indicating a crime or incident has occurred in which a citizen may likely be injured and the assisting municipality is closer to the area than the officer receiving the call.
- e. Concurrent law enforcement jurisdiction in and throughout the territorial limits of Bal Harbour Village and the Town of Surfside for investigations of homicides, sex offenses, robberies, assaults, batteries, burglaries, larcenies, gambling, motor vehicle thefts, drug violations pursuant to Chapter 893, Florida Statutes, and inter-agency task forces and/or joint investigations.

Prior to any officer taking enforcement action pursuant to paragraphs (a) through (e) above, the officer shall notify the jurisdiction in which the action will be taken, unless exigent circumstances prevent such prior notification, in which case notification shall be made as soon after the action as practicable. If the agency having normal jurisdiction responds to the scene the assisting agency's officer may turn the situation over to them and offer any assistance requested including, but not limited to, a follow-up written report documenting the event and the actions taken.

These provisions are not intended to grant general authority to conduct investigations, serve warrants and/or subpoenas or to respond without request to emergencies already being addressed by the agency of normal jurisdiction, but is intended to address critical, life-threatening or public safety situations, prevent bodily injury to citizens, or secure apprehension of criminals whom the law enforcement officer may encounter.

SECTION II: PROVISIONS FOR OPERATIONAL ASSISTANCE

The aforesaid law enforcement agencies hereby approve and enter into this Agreement whereby each of the agencies may request and render law enforcement assistance to the other to include, but not necessarily be limited to dealing with, the following:

- a. Joint multi-jurisdictional criminal investigations.
- b. Civil affray or disobedience, disturbances, riots, large protest demonstrations and assemblies, controversial trials, political conventions, labor disputes, and strikes.
- c. Any natural, technological or manmade disaster.
- d. Incidents which require rescue operations and crowd and traffic control measures including, but not limited to, large-scale evacuations, aircraft and shipping disasters, fires, explosions, gas line leaks, radiological incidents, train wrecks and derailments, chemical or hazardous waste spills, and

- electrical power failures.
- e. Terrorist activities including, but not limited to, acts of sabotage.
- f. Escapes from, or disturbances within, prisoner processing facilities.
- g. Hostage and barricaded subject situations, and aircraft piracy.
- h. Control of major crime scenes, area searches, perimeter control, back-ups to emergency and in-progress calls, pursuits, and missing person calls.
- i. Enemy attack.
- j. Transportation of evidence requiring security.
- k. Major events, e.g., sporting events, concerts, parades, fairs, festivals, and conventions.
- l. Security and escort duties for dignitaries.
- m. Incidents requiring utilization of specialized units; e.g., underwater recovery, marine patrol, aircraft, canine, motorcycle, bicycle, mounted, SWAT, bomb, crime scene and police information.
- n. Emergency situations in which one agency cannot perform its functional objective.
- o. Joint training in areas of mutual need.
- p. Joint multi-jurisdictional marine interdiction operations.
- q. Off-duty special events.
- r. DUI Checkpoints.

SECTION III: PROCEDURE FOR REQUESTING OPERATIONAL ASSISTANCE

- a. Mutual aid requested or rendered will be approved by the Chief of Police, or designee. The Chief of Police, or designee, of the agency whose assistance is sought shall evaluate the situation and the agency's available resources, consult with his/her supervisors, if necessary, and will respond in a manner he/she deems appropriate.
- b. The Chief of Police in whose jurisdiction assistance is being rendered may determine who is authorized to lend assistance in his/her jurisdiction, for how long such assistance is authorized, and for what purpose such authority is granted. This authority may be granted either verbally or in writing as the particular situation dictates.
- c. Specific reporting instructions for personnel rendering mutual aid will be included in the request for mutual aid. In the absence of such reporting instructions, personnel will report to the ranking on-duty supervisor on the scene.
- d. Communications instructions should be included in each request for mutual aid and each agency's communications centers will maintain radio contact with each other until the mutual aid situation

has ended.

- e. Incidents requiring mass processing of arrestees, transporting prisoners, and operating temporary detention facilities will be handled per established procedures of the requesting agency or Chief of Police involved.

SECTION IV: COMMAND AND SUPERVISORY RESPONSIBILITY

a. COMMAND:

The personnel and equipment that are assigned by the assisting Chief of Police shall be under the immediate command of a supervising officer designated by the assisting Chief of Police. Such supervising officer shall be under the direct supervision and command of the Chief of Police or his/her designee of the agency requesting assistance.

b. CONFLICTS:

Whenever an officer is rendering assistance pursuant to this Agreement, the officer shall abide by and be subject to the rules and regulations, personnel policies, general orders, and standard operating procedures of his/her own employer. If any such rule, regulation, personnel policy, general order or standing operating procedure is contradicted, contravened or otherwise in conflict with a direct order of a superior officer of the requesting agency, then such rule, regulation, policy, general order or procedure shall control and shall supersede the direct order.

c. HANDLING COMPLAINTS:

Whenever there is cause to believe that a complaint has arisen as a result of a cooperative effort as it may pertain to this Agreement, the Chief of Police or his/her designee of the agency employing the officer who is the subject of the complaint shall be responsible for the investigation of the complaint. The Chief of Police or designee of the requesting agency should ascertain at a minimum:

1. The identity of the complainant;
2. An address where the complaining party can be contacted;
3. The specific allegation; and
4. The identity of the employees accused without regard as to agency affiliation.

If it is determined during the investigation of a complaint that the accused is an employee of the assisting agency, the above information, with all pertinent documentation gathered during the receipt and processing of the complaint, shall be forwarded without delay to the agency for administrative review. The requesting agency may conduct a review of the complaint to determine if any factual basis for the complaint exists and/or whether any of the employees of the requesting agency violated any

of their agency's policies or procedures.

SECTION V: LIABILITY

Each party engaging in any mutual cooperation and assistance, pursuant to this Agreement, agrees to assume responsibility for the acts, omissions or conduct of such party's own employees while engaged in rendering such aid pursuant to this Agreement, subject to the provisions of Section 768.28, Florida Statutes, where applicable.

SECTION VI: POWERS, PRIVILEGES, IMMUNITIES AND COSTS

- a. Employees of Bal Harbour Village and the Town of Surfside when actually engaging in mutual cooperation and assistance outside of their normal jurisdictional limits but inside this State, under the terms of this Agreement, shall, pursuant to the provisions of Section 23.127 (1), Fla. Stat. (as amended), have the same powers, duties, rights, privileges and immunities as if the employee was performing duties inside the employee's political subdivision in which normally employed.
- b. Each party agrees to furnish necessary personnel equipment, resources and facilities and to render services to each other party to this Agreement as set forth above; provided, however, that no party shall be required to deplete unreasonably its own personnel, equipment, resources, facilities, and services in furnishing such mutual aid.
- c. The political subdivision that furnishes equipment pursuant to this Agreement must bear the cost of loss or damage to that equipment and must pay any expense incurred in the operation and maintenance of that equipment.
- d. The political subdivision furnishing aid pursuant to this Agreement shall compensate its employees during the time of the rendering of aid and shall defray (provide for the payment of) the actual travel and maintenance expenses of its employees while they are rendering aid, including any amounts paid or due for compensation for personal injury or death while its employees are rendering aid.
- e. The privileges and immunities from liability, exemption from laws, ordinances and rules, and pension, insurance, relief, disability, workers' compensation, salary, death, and other benefits that apply to the activity of an employee of an agency when performing the employee's duties within the territorial limits of the employee's agency apply to the employee to the same degree, manner, and

extent while engaged in the performance of the employee's duties extraterritorially under the provisions of this mutual aid Agreement. This section applies to paid, volunteer, reserve and auxiliary employees.

- f. Nothing herein shall prevent the requesting agency from requesting supplemental appropriations from the governing authority having budgeting jurisdiction to reimburse the assisting agency for any actual costs or expenses incurred by the assisting agency performing hereunder.

SECTION VII: FORFEITURES

It is recognized that during the course of the operation of this Agreement, property subject to forfeiture under Sections 932.701- 932.707, Florida Statutes, known as the "Florida Contraband Forfeiture Act," may be seized. The property shall be seized, forfeited, and equitably distributed among the participating agencies in proportion to the amount of investigation and participation performed by each agency pursuant of the provisions of the "Florida Contraband Forfeiture Act."

SECTION VIII: INSURANCE

Each political subdivision shall provide, upon request, satisfactory proof of liability insurance by one or more of the means specified in Section 768.28, Florida Statutes, in an amount which is, in the judgment of the governing body of that political subdivision, at least adequate to cover the risk to which that party may be exposed. Should the insurance coverage, however provided, of any party be canceled or undergo material change, that party shall notify all parties to this Agreement of such change within ten (10) days of receipt of the notice or actual knowledge of such change.

SECTION IX: EFFECTIVE DATE

This Agreement shall take effect retroactively from January 1, 2020 upon execution and approval by the hereinafter named officials and shall continue in full force and effect until December 31, 2024. Under no circumstances may this Agreement be renewed, amended or extended except in writing.

SECTION X: CANCELLATION

Either party may cancel its participation in this Agreement upon delivery of written notice to the other political subdivision.

IN WITNESS WHEREOF, the parties hereto cause these presents to be signed on the date first written above.

Mutual Aid Agreement between Town of Surfside
and Bal Harbour Village

AGREED AND ACKNOWLEDGED this ____ day of _____, 2020.

JORGE M. GONZALEZ
Village Manager
Bal Harbour Village, Florida
Date: _____

ATTEST:

DWIGHT S. DANIE
Village Clerk
Bal Harbour Village, Florida

APPROVED AS TO FORM AND
LEGAL SUFFICIENCY:

WEISS SEROTA HELFMAN COLE & BIERMAN, P.L.
Village Attorney
Bal Harbour Village, Florida

RALEIGH FLOWERS Jr.
Chief of Police
Bal Harbour Village, Florida

GUILLERMO OLMEDILLO
Town Manager
Town of Surfside, Florida
Date: _____

ATTEST:

SANDRA N. MCCREADY, MMC
City Clerk
Town of Surfside, Florida

APPROVED AS TO FORM AND
LEGAL SUFFICIENCY:

WEISS SEROTA HELFMAN COLE
& BIERMAN, P.L.
City Attorney
Town of Surfside, Florida

JULIO YERO
Chief of Police
Town of Surfside, Florida



MEMORANDUM

ITEM NO. 3F

To: Honorable Mayor, Vice-Mayor and Members of the Town Commission

From: Guillermo Olmedillo, Town Manager

Date: July 14th, 2020

Subject: Resolution authorizing the Mutual Aid Agreement between the Town of Surfside and the School Board of Miami Dade County through the School Board Police.

It is the responsibility of the governments of the Town of Surfside, Florida, and the School Board of Miami Dade County, Florida, School Board Police Department, to ensure the public safety of their citizens by providing adequate police service to address any foreseeable routine or emergency situation; and because of the existing and continuing possibility of the occurrence of law enforcement problems and other natural or manmade conditions which are likely to be, beyond the control of the services, personnel, equipment or facilities of the participating police departments; these municipalities have the authority to enter into a Mutual Aid Agreement in order to adequately address any and all of these conditions, to protect the public peace and safety, and to preserve the lives and property of the people of the municipalities. The Mutual Aid Agreement specifies the circumstances and conditions under which mutual aid may be requested and rendered regarding police operations.

The Town of Surfside Police Department has mutual aid agreements with many Miami-Dade County law enforcement agencies and the School Board Police Department has been one of them for years. The Town of Surfside and the School Board Police Department benefit and have determined it is advantageous for public safety to receive and extend mutual aid in the form of law enforcement services and resources.

The new Mutual Aid Agreement between the Town of Surfside Police Department and the School Board of Miami Dade County through the School Board Police Department will be in effect upon execution and approval by both parties and shall continue in full force and effect until January 1, 2025. Under no circumstances may this agreement be renewed, amended, or extended except in writing. The Surfside Police Department requires approval and authorization to enter into the new Mutual Aid Agreement at the request of the School Board of Miami Dade County through the School Board Police Department.

Prepared by: Chief Julio Yero

Staff recommends a motion to approve a resolution authorizing the Mutual Aid Agreement between the Town of Surfside and the School Board of Miami Dade County through the School Board Police.

RESOLUTION NO. 2020-_____

A RESOLUTION OF THE TOWN COMMISSION OF THE TOWN OF SURFSIDE, FLORIDA, APPROVING A VOLUNTARY COOPERATION AND OPERATIONAL ASSISTANCE MUTUAL AID AGREEMENT WITH THE SCHOOL BOARD OF MIAMI DADE COUNTY, FLORIDA; PROVIDING FOR AUTHORIZATION; PROVIDING FOR IMPLEMENTATION; AND PROVIDING FOR AN EFFECTIVE DATE.

WHEREAS, the Town of Surfside (the “Town”) has historically entered into mutual aid agreements with other municipalities for the purpose of providing voluntary cooperation and assistance of a routine law enforcement nature across jurisdictional lines; and

WHEREAS, the School Board of Miami Dade County, Florida wish to enter into a Voluntary Cooperation and Operational Assistance Mutual Aid Agreement, in the form attached hereto as Exhibit “A” (the “Agreement”); and

WHEREAS, the Town Commission wishes to approve the Agreement and authorize the Town Manager and Chief of Police to execute the Agreement approved by this Resolution; and

WHEREAS, the Town Commission finds that the Agreement and this Resolution is in the best interest and welfare of the Town.

NOW, THEREFORE, BE IT RESOLVED BY THE TOWN COMMISSION OF THE TOWN OF SURFSIDE, FLORIDA, AS FOLLOWS:

Section 1. **Recitals.** The above-stated recitals are true and correct and are incorporated herein by this reference.

Section 2. **Approval.** That the Town Commission approves the Agreement in substantially the form attached hereto as Exhibit “A.”

Section 3. **Authorization.** That the Town Manager and Chief of Police are hereby authorized to execute the Agreement in substantially the form attached hereto as Exhibit “A.”

Section 4. **Implementation.** The Town Manager, Chief of Police and/or designee are authorized to take any and all action necessary to implement the purposes of this Resolution and the Agreement.

Section 5. **Effective Date.** This Resolution shall become effective immediately upon adoption.

PASSED AND ADOPTED on this -- th day of June, 2020.

Moved By: _____
Second By: _____

FINAL VOTE ON ADOPTION

Commissioner Eliana R. Salzhauer _____
Commissioner Nelly Velasquez _____
Commissioner Charles Kesl _____
Vice Mayor Tina Paul _____
Mayor Charles W. Burkett _____

Charles W. Burkett
Mayor

ATTEST:

Sandra McCready, MMC
Town Clerk

**APPROVED AS TO FORM AND LEGALITY FOR THE USE
AND BENEFIT OF THE TOWN OF SURFSIDE ONLY:**

Weiss Serota Helfman Cole & Bierman, P.L.
Town Attorney

**VOLUNTARY COOPERATION AND OPERATIONAL ASSISTANCE
MUTUAL AID AGREEMENT
BETWEEN THE TOWN OF SURFSIDE, FLORIDA AND
THE SCHOOL BOARD OF MIAMI-DADE COUNTY, FLORIDA THROUGH MIAMI-DADE
SCHOOLS POLICE DEPARTMENT**

This Voluntary Cooperation and Operational Assistance Mutual Aid Agreement (“Cooperation Agreement”) is made as of this ____ day of _____, 2020 (“Effective Date”), by and between the School Board of Miami-Dade County, a political subdivision of the State of Florida, by and through the Miami-Dade Schools Police Department, whose principal office is located at 3300 NW 27 Avenue, Miami, Florida 33142, and the Town of Surfside, Florida, whose principal office is located at 9293 Harding Avenue, Surfside, FL 33154, state as follows:

RECITALS

WHEREAS, it is the responsibility of the government of the Town of Surfside, Florida, and the Miami-Dade Schools Police Department, Florida to ensure the public safety of their respective citizens by providing adequate levels of police services to address any foreseeable routine or emergency situation; and

WHEREAS, because of the existing and continuing possibility of the occurrence of law enforcement problems and other natural and man-made conditions which are, or are likely to be, beyond the control of the services, personnel, equipment, or facilities of the Surfside Police Department or the Miami-Dade Schools Police Department; and

WHEREAS, in order to ensure that preparation of these law enforcement agencies will be adequate to address any and all of these conditions, to protect the public peace and safety, and to preserve the lives and property of the people of the Town of Surfside, Florida, and the Miami-Dade Schools Police Department, Florida; and

WHEREAS, it is to the advantage of each law enforcement agency to receive and extend mutual aid in the form of law enforcement services and resources to adequately respond to:

- (1) Continuing, multi jurisdiction law enforcement problems, so as to protect the public peace and safety, and preserve the lives and property of the people; and
- (2) Intensive situations including but not limited to emergencies as defined under Section 252.34 of the Florida Statutes, or requests for certain law enforcement services specified herein and as defined under Section 23.1225 of the Florida Statutes; and

WHEREAS, the Town of Surfside and the Miami-Dade Schools Police Department have the voluntary cooperation and assistance authority under the Florida Mutual Aid Act, Sections 23.12 - 23.127 of the Florida Statutes, to enter into this Voluntary Cooperation and Operational Assistance Mutual Aid Agreement for law enforcement service which:

- (1) Permits voluntary cooperation and operational assistance of a routine law enforcement nature across jurisdictional lines as allowed under Section 23.1225, of the Florida Statutes; and
- (2) Provides for rendering of assistance in a law enforcement emergency as defined in Section 252.34 of the Florida Statutes.

NOW THEREFORE, BE IT KNOWN that the Town of Surfside, Florida, and the Miami-Dade Schools Police Department, Florida, in consideration for mutual promises to render valuable aid in times of necessity, do hereby agree to fully and faithfully abide by and be bound by the following terms and conditions:

SECTION I. PROVISIONS FOR VOLUNTARY COOPERATION

Each of the aforesaid law enforcement agencies hereby approve and enter into this Cooperation Agreement whereby each of the agencies may request and render law enforcement assistance to the other in dealing with any violations of Florida Statutes to include, but not necessarily be limited to, investigating sex offenses, robberies, assaults, batteries, burglaries, larcenies, gambling, motor vehicle thefts, drug violations pursuant to Chapter 893 of the Florida Statutes, backup services during patrol activities, and interagency task forces and/or joint investigations as set forth pursuant to, and under the authority of Chapter 23 of the Florida Statutes.

SECTION II. PROVISIONS FOR OPERATIONAL ASSISTANCE

The aforesaid law enforcement agencies hereby approve and enter into this Cooperation Agreement whereby each of the agencies may request and render law enforcement assistance to the other to include, but not necessarily be limited to dealing with, the following:

1. Joint multi-jurisdictional criminal investigations.
2. Civil affray or disobedience, disturbances, riots, large protest demonstrations and assemblies, controversial trials, political conventions, labor disputes, and strikes.
3. Any natural disaster.
4. Incidents which require rescue operations and crowd and traffic control measures including, but not limited to, large-scale evacuations, aircraft and shipping disasters, fires, explosions, gas line leaks, radiological incidents, train wrecks and derailments, chemical or hazardous waste spills, and electrical power failures.
5. Terrorist activities including, but not limited to, acts of sabotage.
6. Escapes from, or disturbances within, prisoner processing facilities.
7. Hostage and barricaded subject situations, and aircraft piracy.
8. Control of major crime scenes, area searches, perimeter control, back-ups to emergency and in-progress calls, pursuits, and missing person calls.
9. Enemy attack.
10. Transportation of evidence requiring security.
11. Major events, e.g., sporting events, concerts, parades, fairs, festivals, and conventions.
12. Security and escort duties for dignitaries.
13. Incidents requiring utilization of specialized units; e.g., underwater recovery, aircraft, canine, motorcycle, bomb, crime scene and police information.
14. Emergency situations in which one agency cannot perform its functional objective.
15. Joint training in areas of mutual need.
16. Joint multi-jurisdictional marine interdiction operations.
17. DUI Checkpoints.

The following procedures will apply in mutual aid operations:

1. Mutual aid requested or rendered will be approved by the Chief of Police, or designee.

2. Specific reporting instructions for personnel rendering mutual aid will be included in the request for mutual aid. In the absence of such instructions, personnel will report to the ranking on-duty supervisor on the scene.
3. Communications instructions will be included in each request for mutual aid and each agency's communications centers will maintain in radio contact with each other until the mutual aid situation has ended.
4. Incidents requiring mass processing of arrestees, transporting prisoners, and operating temporary detention facilities will be handled per established procedures of the requesting agency, or directors involved.

SECTION III. PROCEDURE FOR REQUESTING ASSISTANCE AND LIMITATIONS OF ASSISTANCE

In the event that a party to this Cooperation Agreement is in need of assistance as set forth above, the Chief of Police or his/her designee, shall notify the Chief of Police or his/her designee from whom such assistance is requested. The Chief of Police or authorized agency representative whose assistance is sought shall evaluate the situation and the agency's available resources, consult with his/her supervisors, if necessary, and will respond in a manner he/she deems appropriate.

The Chief of Police in whose jurisdiction assistance is being rendered may determine who is authorized to lend assistance in his/her jurisdiction, for how long such assistance is authorized, and for what purpose such authority is granted. This authority may be granted either verbally or in writing as the particular situation dictates.

Should a law enforcement officer be in another subscribed agency's jurisdiction for matters of a routine nature, such as traveling through the area on routine business, attending a meeting or going to or from work, and a violation of Florida Statutes occurs in the presence of said party, representing his/her respective agency, **HE/SHE SHALL ONLY BE EMPOWERED TO RENDER ENFORCEMENT ASSISTANCE AND ACT IN ACCORDANCE WITH FLORIDA LAW.** Should enforcement assistance be taken, said party shall notify the agency having normal jurisdiction, and upon the latter's arrival, turn the situation over to them and offer any assistance requested, including but not limited to, a follow-up written report documenting the event and the actions taken. This provision, so prescribed in this paragraph, shall not grant general authority to conduct investigations, serve warrants, and/or subpoenas or to respond without request to emergencies already being addressed by the agency of normal jurisdiction, but is intended to address critical, life-threatening or public safety situations, prevent bodily injury to citizens, or secure apprehension of criminals whom the law enforcement officer may encounter and such encounter results in a breach of the peace.

The parties acknowledge that the policy of the Florida Mutual Aid Act is to ensure that preparations of this State will be adequate to deal with the occurrence of natural or manmade disasters or emergencies, protect the public peace and safety, and preserve the lives and property of the people of this State. This Cooperation Agreement shall not extend police powers beyond the specific additional authority granted by the Legislature in Chapter 23 of the Florida Statutes, and the respective parties, police officers and authority are limited to those instances where the subject matter of the investigation originates inside the municipal city limits.

SECTION IV. COMMAND AND SUPERVISORY RESPONSIBILITY

The personnel and equipment that are assigned by the assisting Agency shall be under the immediate command of a supervising officer designated by the assisting Agency. Such supervising officer shall be under the direct supervision and command of the Chief of Police or his/her designee of the agency requesting assistance.

SECTION V. CONFLICTS

Whenever an officer is rendering assistance pursuant to this Cooperation Agreement, the officer shall abide by and be subject to the rules and regulations, personnel policies, general orders, and standard operating procedures of his/her own employer. If any such rule, regulation, personnel policy, general order or standard operating procedure is contradicted, contravened or otherwise in conflict with a direct order of a superior officer of the requesting agency, then such rule, regulation, policy, general order or procedure shall control and shall supersede the direct order.

SECTION VI. HANDLING COMPLAINTS

Whenever there is cause to believe that a complaint has arisen as a result of a cooperative effort as it may pertain to this Cooperation Agreement, the Chief of Police or his/her designee of the requesting agency shall be responsible for the documentation of said complaint to ascertain at a minimum:

1. The identity of the complainant.
2. An address where the complaining party can be contacted.
3. The specific allegation
4. The identity of the employees accused without regard as to agency affiliation.

If it is determined that the accused is an employee of the assisting agency, the above information, with all pertinent documentation gathered during the receipt and processing of the complaint, shall be forwarded without delay to the agency for administrative review. The requesting agency may conduct a review of the complaint to determine if any factual basis for the complaint exists and/or whether any of the employees of the requesting agency violated any of their agency's policies or procedures.

SECTION VII. LIABILITY

Each party engaging in any mutual cooperation and assistance, pursuant to this Cooperation Agreement, agrees to assume full and final responsibility for the acts, omissions or conduct of such party's own employees while engaged in rendering such aid pursuant to this Cooperation Agreement, subject to the provisions of Section 768.28 of the Florida Statutes, where applicable.

SECTION VIII. POWERS, PRIVILEGES, IMMUNITIES AND EXPENDITURES

(a) Employees of the Town of Surfside and the Miami-Dade Schools Police Department, when actually engaging in mutual cooperation and assistance outside of their normal jurisdictional limits but inside this State, under the terms of this Agreement, shall, pursuant to the provisions of

Section 23.127(1) of the Florida Statutes (as amended) and this Cooperation Agreement, have the same powers, duties, rights, privileges and immunities as if the employee was performing duties inside the employee's political subdivision in which normally employed.

(b) Each party agrees to furnish necessary personnel equipment, resources and facilities and to render services to each other party to this Cooperation Agreement as set forth above; provided however, that no party shall be required to deplete unreasonably its own personnel, equipment, resources, facilities, and services in furnishing such mutual aid.

(c) A party that furnishes equipment pursuant to this Cooperation Agreement must bear the cost of loss or damage to that equipment and must pay any expense incurred in the operation and maintenance of that equipment.

(d) The agency furnishing aid pursuant to this Cooperation Agreement shall compensate its appointees/employees during the time such aid is rendered and shall defray the actual travel and maintenance expenses of its employees while they are rendering such aid, including any amounts paid or due for compensation due to personal injury or death while such employees are engaged in rendering such aid.

(e) To the extent provided by applicable law, ordinance, or rule, the privileges and immunities from liability, exemption from laws, ordinances and rules, and all pension, insurance, relief, disability, worker's compensation, salary, death and other benefits that apply to the activity of an employee of an agency when performing the employee's duties within the territorial limits of the employee's agency apply to the employee to the same degree, manner, and extent while engaged in the performance of the employee's duties extraterritorially under the provisions of this Cooperation Agreement. The provisions of this section shall apply to paid, volunteer, reserve and auxiliary employees.

(f) Nothing herein shall prevent the requesting agency from requesting supplemental appropriations from the governing authority having budgeting jurisdiction to reimburse the assisting agency for any actual costs or expenses incurred by the assisting agency performing hereunder.

(g) Should the Town of Surfside receive reimbursement for expenditures from a third party for a mutual aid event covered by this Cooperation Agreement, the Miami-Dade Schools Police Department shall be eligible to receive an equitable reimbursement share for any actual costs or expenses incurred that are directly attributable to the event, provided such costs and expenses are authorized by the third party for reimbursement purposes.

(h) Should the Miami-Dade Schools Police Department receive reimbursement for expenditures from a third party for a mutual aid event covered by this Cooperation Agreement, the Town of Surfside shall be eligible to receive an equitable reimbursement share for any actual costs or expenses incurred that are directly attributable to the event, provided such costs and expenses are authorized by the third party for reimbursement purposes.

(i) The parties acknowledge that the Miami-Dade Schools Police Department and the Town of Surfside are authorized to pursue any property seized pursuant to the Florida Contraband Forfeiture Act. Each party shall have the exclusive authority to initiate forfeiture proceedings originating in its respective jurisdiction under the Florida Contraband Act for any matters which arise from a mutual aid event that is covered by this Cooperation Agreement. The agency pursuing the forfeiture action shall have the exclusive right to control, and the responsibility to maintain the property including, but not limited to, the complete discretion to bring the action, dismiss the action, or settle

the action. Each respective party, upon successfully prosecuting a forfeiture action, shall equitably share in those proceeds forfeited, as acceptable to the Chief of Police of the Miami-Dade Schools Police Department and Chief of Police for the Town of Surfside.

SECTION IX. INSURANCE

Each party shall provide, upon request, satisfactory proof of liability insurance by one or more of the means specified in Section 768.28(16)(a) of the Florida Statutes, in an amount which is, in the judgment of the governing body of that party, at least adequate to cover the risk to which that party may be exposed. Should the insurance coverage, however provided, of any party be canceled or undergo material change, that party shall notify all parties to this agreement of such change within ten (10) days of receipt of notice or actual knowledge of such change.

SECTION X. EFFECTIVE DATE

This Agreement shall take effect upon execution and approval by both parties and shall continue in full force and effect until January 1, 2025. Under no circumstances may this agreement be renewed, amended, or extended except in writing.

SECTION XI. CANCELLATION

Either party may cancel its participation in this Agreement at any time upon delivery of written notice within thirty (30) days to the other party.

In witness whereof, the parties hereto cause to these presents to be signed on the date specified.

(SIGNATURE PAGE TO FOLLOW)

AGREED TO AND ACKNOWLEDGED this _____ day of _____, 2020.

MIAMI-DADE SCHOOLS
POLICE DEPARTMENT, FLORIDA

TOWN OF SURFSIDE, FLORIDA

EDWIN LOPEZ
CHIEF OF POLICE

JULIO YERO
CHIEF OF POLICE

Date: _____

Date: _____

MR. ALBERTO M. CARVALHO
SUPERINTENDENT
MIAMI-DADE COUNTY PUBLIC SCHOOLS

GUILLERMO OLMEDILLO
TOWN MANAGER

Date: _____

Date: _____

CRISTINA R. CORREA, ATTORNEY
MIAMI-DADE COUNTY PUBLIC SCHOOLS

LILLIAN ARANGO
TOWN ATTORNEY

Date: _____

Date: _____

ATTEST:

MICHAEL G. FOX, RISK MANAGEMENT
MIAMI-DADE COUNTY PUBLIC SCHOOLS

SANDRA MCCREADY
TOWN CLERK

PAGE NUMBERS 204 TO 221

INTENTIONALLY LEFT BLANK



MEMORANDUM

ITEM NO. 5A

To: Honorable Mayor, Vice-Mayor and Members of the Town Commission
From: Jason Greene, Interim Town Manager
Date: July 14, 2020
Subject: Independent External Audit Reengagement Resolution

The Town has previously engaged Marcum LLP (“Marcum”) to provide annual financial auditing services. The current engagement commitment from the Town has expired. Marcum has prepared a proposal for additional services for Fiscal Year 2020 as attached. Marcum has provided the Town with consistently superior services during prior engagements.

The Town is required to undertake an annual independent financial audit. The fee will be \$62,000 and there will be sufficient funding in the FY 2021 budget for this expense. Should the Town be required to have a single audit performed because it spent more than \$750,000 in either federal or state grant funds, additional pre-negotiated fees would be required. The only potential grants would be Federal Emergency Management Agency (FEMA) funds reimbursing the Town for declared disasters.

The Administration recommends approval of the resolution that would reengage the Town’s current external auditors.

Reviewed by: LA

Prepared by: JDG

RESOLUTION NO. 2020-_____

A RESOLUTION OF THE TOWN COMMISSION OF THE TOWN OF SURFSIDE, FLORIDA, APPROVING AN ENGAGEMENT LETTER WITH MARCUM LLP FOR FINANCIAL AUDITING SERVICES FOR FISCAL YEAR ENDING SEPTEMBER 30, 2020; PROVIDING FOR AUTHORIZATION; PROVIDING FOR IMPLEMENTATION; AND PROVIDING FOR AN EFFECTIVE DATE.

WHEREAS, the Town of Surfside (“Town”) Commission wishes to continue engaging the firm of Marcum LLP (the “Auditor”) for professional auditing services for the fiscal year ending on September 30, 2020; and

WHEREAS, the Auditor has provided the Town with a proposed Auditing Services Engagement Letter (the “Agreement”); and

WHEREAS, the Town Commission finds that approving the Agreement with the Auditor in substantially the form attached hereto as Exhibit “A,” together with such changes as may be required by the Town Manager and/or Town Attorney, is in the best interest and welfare of the Town.

NOW, THEREFORE, BE IT RESOLVED BY THE TOWN COMMISSION OF THE TOWN OF SURFSIDE, FLORIDA, AS FOLLOWS:

Section 1. Recitals. That the above-stated recitals are true and correct and are incorporated herein by this reference.

Section 2. Approval. That the Town Commission approves the Agreement in substantially the form attached hereto as Exhibit “A,” together with such changes as may be acceptable to the Town Manager.

Section 3. Authorization. That the Town Manager is hereby authorized to execute the Agreement, subject to approval by the Town Attorney as to form, content, and legal sufficiency.

Section 4. Implementation. That the Town Manager and/or designee are authorized to expend budgeted funds and take any and all action necessary to implement the purposes of this Resolution and the Agreement.

Section 5. Effective Date. This Resolution shall become effective immediately upon adoption.

PASSED AND ADOPTED on this 14th day of July, 2020.

Moved By: _____

Second By: _____

FINAL VOTE ON ADOPTION

Commissioner Charles Kesl _____

Commissioner Eliana R. Salzhauer _____

Commissioner Nelly Velasquez _____

Vice Mayor Tina Paul _____

Mayor Charles W. Burkett _____

Charles W. Burkett, Mayor

ATTEST:

Sandra Novoa, MMC
Town Clerk

**APPROVED AS TO FORM AND LEGALITY FOR THE USE
AND BENEFIT OF THE TOWN OF SURFSIDE ONLY:**

Weiss Serota Helfman Cole & Bierman, P.L.
Town Attorney

July 1, 2020

Honorable Mayor, Town Commission and Town Manager
Town of Surfside
9293 Harding Avenue
Surfside, FL 33154

Re: Engagement of Marcum LLP

We are pleased to confirm our understanding of the services Marcum LLP (“Marcum,” the “Firm,” “we,” “us” or “our”) are to provide Town of Surfside, Florida (the “Town,” “you” or “your”) for the fiscal year ending September 30, 2020. We will audit the financial statements of the governmental activities, the business-type activities, each major fund, and the aggregate remaining fund information, including the related notes to the financial statements, which collectively comprise the basic financial statements of the Town as of and for the fiscal year ending September 30, 2020. Accounting standards generally accepted in the United States of America provide for certain required supplementary information (RSI), such as management’s discussion and analysis (MD&A), to supplement Town’s basic financial statements. Such information, although not part of the basic financial statements, is required by the Governmental Accounting Standards Board who considers it to be an essential part of financial reporting for placing the basic financial statements in an appropriate operational, economic, or historical context. As part of our engagement, we will apply certain limited procedures to Town’s RSI in accordance with auditing standards generally accepted in the United States of America. These limited procedures will consist of inquiries of management regarding the methods of preparing the information and comparing the information for consistency with management’s responses to our inquiries, the basic financial statements, and other knowledge we obtained during our audit of the basic financial statements. We will not express an opinion or provide any assurance on the information because the limited procedures do not provide us with sufficient evidence to express an opinion or provide any assurance. The following RSI is required by generally accepted accounting principles and will be subjected to certain limited procedures, but will not be audited:

- 1) Management’s Discussion and Analysis
- 2) Schedule of Changes in Town’s Net Pension Liability and Related Ratios
- 3) Schedule of Town Contributions – Pensions
- 4) Schedule of Changes in Town’s Total OPEB Liability and Related Ratios
- 5) Budgetary Comparison Schedules

We have also been engaged to report on supplementary information other than RSI that accompanies Town’s financial statements. We will subject the following supplementary information to the auditing procedures applied in our audit of the basic financial statements and certain additional procedures, including comparing and reconciling such information directly to

the underlying accounting and other records used to prepare the financial statements or to the financial statements themselves, and other additional procedures in accordance with auditing standards generally accepted in the United States of America, and will provide an opinion on it in relation to the basic financial statements as a whole:

- 1) Schedule of Expenditures of Federal Awards and State Financial Assistance, as applicable
- 2) Combining and Individual Fund Statements and Schedules

The following other information accompanying the basic financial statements will not be subjected to the auditing procedures applied in our audit of the financial statements, and our auditors' report will not provide an opinion or any assurance on that other information.

- 1) Introductory Section
- 2) Statistical Section

Audit Objectives

The objective of our audit is the expression of opinions as to whether your basic financial statements are fairly presented, in all material respects, in conformity with U.S. generally accepted accounting principles and to report on the fairness of the supplementary information referred to in the second paragraph when considered in relation to the financial statements as a whole. The objective also includes reporting on:

- Internal control over financial reporting and compliance with provisions of laws, regulations, contracts, and award agreements, noncompliance with which could have a material effect on the financial statements in accordance with *Government Auditing Standards*.
- Internal control over compliance related to major programs and an opinion (or disclaimer of opinion) on compliance with federal statutes, regulations, and the terms and conditions of federal awards that could have a direct and material effect on each major program in accordance with the Single Audit Act Amendments of 1996 and Title 2 U.S. *Code of Federal Regulations* (CFR) Part 200, *Uniform Administrative Requirements, Cost Principles, and Audit Requirements for Federal Awards (Uniform Guidance)*, and the Florida Single Audit Act and Chapter 10.550, Rules of the Auditor General of the State of Florida. The *Government Auditing Standards* report on internal control over financial reporting and on compliance and other matters will include a paragraph that states that (1) the purpose of the report is solely to describe the scope of testing of internal control and compliance and the results of that testing, and not to provide an opinion on the effectiveness of the entity's internal control or on compliance, and (2) the report is an integral part of an audit performed in accordance with *Government Auditing Standards* in considering the entity's internal control and compliance. The *Uniform Guidance* and Florida Single Audit Act report on internal control over compliance will include a paragraph that states that the purpose of the report on internal control over compliance is solely to describe the scope of testing of internal control over compliance and the results of that testing based on the requirements of the *Uniform Guidance* and the Florida Single Audit Act. Both reports will state that the report is not suitable for any other purpose.

Our audit will be conducted in accordance with auditing standards generally accepted in the United States of America; the standards for financial audits contained in *Government Auditing Standards*, issued by the Comptroller General of the United States; the Single Audit Act Amendments of 1996; and the provisions of the Uniform Guidance, and the Florida Single Audit Act and Chapter 10.550, Rules of the Auditor General of the State of Florida and will include tests of accounting records, a determination of major program(s) in accordance with the Uniform Guidance and the Florida Single Audit Act and other procedures we consider necessary to enable us to express such opinions. We will issue written reports upon completion of our Single Audit. Our reports will be addressed to the Honorable Mayor, Town Commission and Town Manager.

We cannot provide assurance that unmodified opinions will be expressed. Circumstances may arise in which it is necessary for us to modify our opinions or add emphasis-of-matter or other-matter paragraphs. If our opinions on the financial statements or the Single Audit compliance opinions are other than unmodified, we will discuss the reasons with you in advance. If, for any reason, we are unable to complete the audit or are unable to form or have not formed opinions, we may decline to express opinions or issue reports, or may withdraw from this engagement.

Audit Procedures – General

An audit includes examining, on a test basis, evidence supporting the amounts and disclosures in the financial statements; therefore, our audit will involve judgment about the number of transactions to be examined and the areas to be tested. An audit also includes evaluating the appropriateness of accounting policies used and the reasonableness of significant accounting estimates made by management, as well as evaluating the overall presentation of the financial statements. We will plan and perform the audit to obtain reasonable rather than absolute assurance about whether the financial statements are free of material misstatement, whether from (1) errors, (2) fraudulent financial reporting, (3) misappropriation of assets, or (4) violations of laws or governmental regulations that are attributable to the Town or to acts by management or employees acting on behalf of the Town. Because the determination of abuse is subjective, *Government Auditing Standards* do not expect auditors to provide reasonable assurance of detecting abuse.

Because of the inherent limitations of an audit, combined with the inherent limitation of internal control, and because we will not perform a detailed examination of all transactions, there is a risk that material misstatements or noncompliance may exist and not be detected by us, even though the audit is properly planned and performed in accordance with U.S. generally accepted auditing standards and *Government Auditing Standards*. In addition, an audit is not designed to detect immaterial misstatements or violations of laws or governmental regulations that do not have a direct and material effect on the financial statements or major programs. However, we will inform the appropriate level of management of any material errors, any fraudulent financial reporting, or misappropriation of assets that come to our attention. We will also inform the appropriate level of management of any violations of laws or governmental regulations that come to our attention, unless clearly inconsequential and of any material abuse that comes to our attention. We will include such matters in the reports required for a Single Audit. Our responsibility as auditors is limited to the period covered by our audit and does not extend to any later periods for which we are not engaged as auditors.

Our procedures will include tests of documentary evidence supporting the transactions recorded in the accounts, and may include tests of the physical existence of inventories, and direct confirmation of receivables and certain other assets and liabilities by correspondence with selected individuals, funding sources, creditors, and financial institutions. We will request written representations from the Town's attorneys as part of the engagement, and they may bill the Town for responding to this inquiry. At the conclusion of our audit, we will require certain written representations from you about your responsibilities for the financial statements; schedule of expenditures of federal awards and state financial assistance, if applicable; federal award programs and state projects, if applicable; compliance with laws, regulations, contracts, and grant agreements; and other responsibilities required by generally accepted auditing standards.

Audit Procedures - Internal Controls

Our audit will include obtaining an understanding of the entity and its environment, including internal control, sufficient to assess the risks of material misstatement of the basic financial statements and to design the nature, timing, and extent of further audit procedures. Tests of controls may be performed to test the effectiveness of certain controls that we consider relevant to preventing and detecting errors and fraud that are material to the financial statements and to preventing and detecting misstatements resulting from illegal acts and other noncompliance matters that have a direct and material effect on the financial statements. Our tests, if performed, will be less in scope than would be necessary to render an opinion on internal control and, accordingly, no opinion will be expressed in our report on internal control issued pursuant to *Government Auditing Standards*.

As required by the Uniform Guidance, the Florida State Single Audit Act and Chapter 10.550 Rules of the Auditor General we will perform tests of controls over compliance to evaluate the effectiveness of the design and operation of controls that we consider relevant to preventing or detecting material noncompliance with compliance requirements applicable to each major federal and state award program. However, our tests will be less in scope than would be necessary to render an opinion on those controls and, accordingly, no opinion will be expressed in our report on internal control issued pursuant to the Uniform Guidance, the Florida State Single Audit Act and Chapter 10.550 Rules of the Auditor General.

An audit is not designed to provide assurance on internal control or to identify significant deficiencies or material weaknesses. However, during the audit, we will communicate to management and those charged with governance internal control related matters that are required to be communicated under AICPA professional standards, *Government Auditing Standards*, and the Uniform Guidance, the Florida State Single Audit Act and Chapter 10.550 Rules of the Auditor General.

Audit Procedures - Compliance

As part of obtaining reasonable assurance about whether the basic financial statements are free of material misstatement, we will perform tests of the Town's compliance with provision of applicable laws, regulations, contracts, and agreements, including grant agreements. However, the objective of those procedures will not be to provide an opinion on overall compliance and we will

not express such an opinion in our report on compliance issued pursuant to *Government Auditing Standards*.

Uniform Guidance, the Florida State Single Audit Act and Chapter 10.550 Rules of the Auditor General requires that we also plan and perform the audit to obtain reasonable assurance about whether the auditee has complied with applicable laws and regulations and the provisions of contracts and grant agreements applicable to major programs. Our procedures will consist of tests of transactions and other applicable procedures described in the *OMB Compliance Supplement*, the Florida State Single Audit Act and Chapter 10.550 Rules of the Auditor General for the types of compliance requirements that could have a direct and material effect on each of the Town's major programs. The purpose of these procedures will be to express an opinion on the Town's compliance with requirements applicable to each of its major programs in our report on compliance issued pursuant to the Uniform Guidance, the Florida State Single Audit Act and Chapter 10.550 Rules of the Auditor General.

Management Responsibilities

Management is responsible for (1) establishing and maintaining effective internal controls, including internal controls over compliance, and for evaluating and monitoring ongoing activities; to help ensure that appropriate goals and objectives are met; (2) following laws and regulations; (3) ensuring that there is reasonable assurance that government programs are administered in compliance with compliance requirements; and (4) ensuring that management and financial information is reliable and properly reported. Management is also responsible for implementing systems designed to achieve compliance with applicable laws, regulations, contracts, and grant agreements. You are also responsible for the selection and application of accounting principles; for the preparation and fair presentation of the financial statements, schedule of expenditures of federal awards and state financial assistance, and all accompanying information in conformity with U.S. generally accepted accounting principles; and for compliance with applicable laws and regulations and the provisions of contracts and grant agreements.

Management is also responsible for making all financial records and related information available to us and for the accuracy and completeness of that information. You are also responsible for providing us with (1) access to all information of which you are aware that is relevant to the preparation and fair presentation of the financial statements, (2) additional information that we may request for the purpose of the audit, and (3) unrestricted access to persons within the government from whom we determine it necessary to obtain audit evidence.

Your responsibilities also include identifying significant vendor relationships in which the vendor has responsibility for program compliance and for the accuracy and completeness of that information. Your responsibilities include adjusting the basic financial statements to correct material misstatements and confirming to us in the management representation letter that the effects of any uncorrected misstatements aggregated by us during the current engagement and pertaining to the latest period presented are immaterial, both individually and in the aggregate, to the financial statements taken as a whole.

You are responsible for the design and implementation of programs and controls to prevent and detect fraud, and for informing us about all known or suspected fraud affecting the government involving (1) management, (2) employees who have significant roles in internal control, and (3) others where the fraud or illegal acts could have a material effect on the financial statements. Your responsibilities include informing us of your knowledge of any allegations of fraud or suspected fraud affecting the Town received in communications from employees, former employees, grantors, regulators, or others. In addition, you are responsible for identifying and ensuring that the Town complies with applicable laws, regulations, contracts, agreements, and grants. Management is also responsible for taking timely and appropriate steps to remedy fraud and noncompliance with provisions of laws, regulations, contracts, and grant agreements, or abuse that we report. Additionally, as required by the Uniform Guidance, the Florida State Single Audit Act and Chapter 10.550 Rules of the Auditor General, it is management's responsibility to follow up and take corrective action on reported audit findings and to prepare a summary schedule of prior audit findings and a corrective action plan.

As applicable, you are responsible for identifying all federal awards and state financial assistance received and understanding and complying with the compliance requirements and for the preparation of the schedule of expenditures of federal awards and state financial assistance (including notes and noncash assistance) in conformity with the Uniform Guidance, the Florida State Single Audit Act and Chapter 10.550 Rules of the Auditor General. You agree to include our report on the schedule of expenditures of federal awards and state financial assistance in any document that contains and indicates that we have reported on the schedule of expenditures of federal awards and state financial assistance. You also agree to include the audited financial statements with any presentation of the schedule of expenditures of federal awards and state financial assistance that includes our report thereon or make the audited financial statements readily available to intended users of the schedule of expenditures of federal awards and state financial assistance no later than the date the schedule of expenditures of federal awards and state financial assistance is issued with our report thereon. Your responsibilities include acknowledging to us in the written representation letter that (1) you are responsible for presentation of the schedule of expenditures of federal awards and state financial assistance in accordance with the Uniform Guidance, the Florida State Single Audit Act and Chapter 10.550 Rules of the Auditor General; (2) you believe the schedule of expenditures of federal awards the Florida State Single Audit Act and Chapter 10.550 Rules of the Auditor General including its form and content, is fairly presented in accordance with Uniform Guidance the Florida State Single Audit Act and Chapter 10.550 Rules of the Auditor General; (3) the methods of measurement or presentation have not changed from those used in the prior period (or, if they have changed, the reasons for such changes); and (4) you have disclosed to us any significant assumptions or interpretations underlying the measurement or presentation of the schedule of expenditures of federal awards and state financial assistance.

You are also responsible for the preparation of the other supplementary information which we have been engaged to report on, in conformity with U.S. generally accepted accounting principles. You agree to include our report on the supplementary information in any document that contains and indicates that we have reported on the supplementary information. You also agree to include the audited financial statements with any presentation of the supplementary information that includes our report thereon OR make the audited financial statements readily available to users of the supplementary information no later than the date the supplementary information is issued with our report thereon. Your responsibilities include acknowledging to us in the written representation

letter that (1) you are responsible for presentation of the supplementary information in accordance with GAAP; (2) you believe the supplementary information, including its form and content, is fairly presented in accordance with GAAP; (3) the methods of measurement or presentation have not changed from those used in the prior period (or, if they have changed, the reasons for such changes); and (4) you have disclosed to us any significant assumptions or interpretations underlying the measurement or presentation of the supplementary information.

At the conclusion of the engagement, we will complete the appropriate sections of the Data Collection Form that summarizes our audit findings. It is management's responsibility to submit the reporting package (including financial statements, schedule of expenditures of federal awards, summary schedule of prior audit findings, auditors' reports, and corrective action plan) along with the Data Collection Form to the federal audit clearinghouse. We will coordinate with you the electronic submission and certification. If applicable, we will provide copies of our report for you to include with the reporting package you will submit to pass-through entities. The Data Collection Form and the reporting package must be submitted within the earlier of 30 days after receipt of the auditors' reports or nine months after the end of the audit period, unless a longer period is agreed to in advance by the cognizant or oversight agency for audits.

Management is responsible for establishing and maintaining a process for tracking the status of audit findings and recommendations. Management is also responsible for identifying and providing report copies of previous financial audits, attestation engagements, performance audits, or other studies related to the objectives discussed in the Audit Objectives section of this letter. This responsibility includes relaying to us corrective actions taken to address significant findings and recommendations resulting from those audits, attestation engagements, performance audits, or studies. You are also responsible for providing management's views on our current findings, conclusions, and recommendations, as well as your planned corrective actions, for the report, and for the timing and format for providing that information.

You agree to assume all management responsibilities relating to the financial statements, schedule of expenditures of federal awards and state financial assistance, related notes, and any other nonaudit/nonattest services we provide. You will be required to acknowledge in the management representation letter our assistance with preparation of the financial statements, schedule of expenditures of federal awards and state financial assistance, and related notes and that you have reviewed and approved the financial statements, schedule of expenditures of federal awards and state financial assistance, and related notes prior to their issuance and have accepted responsibility for them. Further, you agree to oversee the nonaudit/nonattest services by designating an individual, preferably from senior management (the finance director), with suitable skill, knowledge, or experience; evaluate the adequacy and results of those services; and accept responsibility for them.

We will make the distribution of our reports and the financial statements to the Honorable Mayor, Town Commission, Town Manager and the finance director. Unless restricted by law or regulation, or containing privileged and confidential information, copies of our reports are to be made available for public inspection.

With regard to the electronic dissemination of audited financial statements, including financial statements published electronically on your website, you understand that electronic sites are a means to distribute information and, therefore, we are not required to read the information

contained in these sites or to consider the consistency of other information in the electronic site with the original document.

If the Contractor has questions regarding the application of Chapter 119, Florida Statutes, the Contractor's duty to provide public records relating to this contract, contact the Custodian of Public Records at:

Sandra Novoa, MMC, Town Clerk
Town of Surfside
9293 Harding Avenue
Surfside, Florida 33129
(305) 861-4863
snovoa@townofsurfsidefl.gov

Communication with Those Charged with Governance

As part of our engagement, we are responsible for communicating significant matters related to the audit that are, in our professional judgment, relevant to your responsibilities in overseeing the financial reporting process as well as other matters we believe should be communicated to those charged with governance. Generally accepted auditing standards do not require the auditor to design procedures for the purpose of identifying other matters to communicate with those charged with governance. Such matters include, but are not limited to, (1) the initial selection of and changes in significant accounting policies and their application; (2) the process used by management in formulating particularly sensitive accounting estimates and the basis for our conclusions regarding the reasonableness of those estimates; (3) all passed audit adjustments; (4) any disagreements with management, whether or not satisfactorily resolved, about matters that individually or in the aggregate could be significant to the financial statements or our report; (5) our views about matters that were the subject of management's consultation with other accountants about auditing and accounting matters; (6) major issues that were discussed with management in connection with the retention of our services, including, among other matters, any discussions regarding the application of accounting principles and auditing standards; (7) serious difficulties that we encountered in dealing with management related to the performance of the audit; and (8) matters relating to our independence as your auditors.

Reproduction of Auditors' Report

If you intend to publish or otherwise reproduce the financial statements and make reference to our Firm, you agree to provide us with printers' proofs or masters for our review and approval before printing. You also agree to provide us with a copy of the final reproduced material for our approval before it is distributed. In addition, to avoid unnecessary delay or misunderstanding, it is important that you give us timely notice of your intention to issue any such document.

If the Town elects to issue public debt and not have us associated with the proposed offering. We agree that our association with the proposed offering is not necessary providing that the Town agrees to clearly indicate that we are not associated with the contents of any such official statement or memorandum. The Town agrees that the following disclosure will be prominently displayed in any such official statement or memorandum.

Marcum LLP has not been engaged to perform, and has not performed, since the date of its report included herein, any procedures on the financial statements addressed in that report. Marcum LLP, also has not performed any procedures relating to this official statement.

Assistance By Your Personnel

We will ask that your personnel, to the extent possible, prepare required schedules and analyses, and make selected invoices and other required documents available to our staff. This assistance by your personnel will serve to facilitate the progress of our work and minimize our time requirements.

You acknowledge that your confidential information may be transmitted to us through an information portal or delivery system established by us or on our behalf. You shall notify us in writing of your employees, representatives, or other agents to be provided access to such portal or system; upon the termination of such status, you shall immediately notify us in writing. You acknowledge that you are responsible for the actions of your current and former employees, representatives, or other agents in connection with the transmission of your information.

Background Checks

As a matter of Firm policy, we perform background checks, which may require out-of-pocket expenses, on potential clients and/or on existing clients, on an as-determined basis. The terms and conditions of this engagement are expressly contingent upon the satisfactory completion of our investigatory procedures and we reserve the right to withdraw from any relationship should information which we deem to be adverse come to our attention. The results of all background checks and other investigatory procedures are submitted to, and reviewed by, our Firm's Client Acceptance Committee.

Independence

Professional standards require that a firm and its members maintain independence throughout the duration of the professional relationship with a client. In order to preserve the integrity of our relationship, no offer of employment shall be discussed with any Marcum professionals assigned to the audit, including within the one year period prior to the commencement of the year-end audit. Should such an offer of employment be made, or employment commences during the indicated time period, we will consider this an indication that our independence has been compromised. As such, we may be required to recall our auditors' report due to our lack of independence. In the event additional work is required to satisfy independence requirements, such work will be billed at our standard hourly rates. Furthermore, we strive to staff your engagement with quality, superbly trained professionals. In recognition of the extensive investment we have made to recruit and develop our personnel, we ask that you agree to the following. In the event that any of our employees accepts a position of employment with your organization, or any of its related parties at any time while we are performing services for you or within one year thereafter, you agree to pay us a placement fee equal to the employee's annual compensation in effect on the date such employment was contracted. Such fee is payable when the employee accepts such a position.

Confidentiality/Access to Working Papers

To the extent that, in connection with this engagement, Marcum comes into possession of your proprietary or confidential information, Marcum will not, except as described herein, disclose such information to any third party without consent, except (a) as may be required by law, regulation, judicial or administrative process, or in accordance with applicable professional standards, or in connection with litigation pertaining to the subject matter of this engagement letter, or (b) to the extent such information (i) shall have otherwise become publicly available (including, without limitation, any information filed with any governmental agency and available to the public) other than as the result of a disclosure by Marcum in breach hereof, (ii) is disclosed by you to a third party without substantially the same restrictions as set forth herein, (iii) becomes available to Marcum on a non-confidential basis from a source other than you, your employees or agents which Marcum believes is not prohibited from disclosing such information to Marcum by obligation to you, (iv) is known by Marcum prior to its receipt from you, your employees or agents without any obligation of confidentiality with respect thereto, or (v) is developed by Marcum independently of any disclosures made by you or your employees or agents to Marcum of such information. In addition, you acknowledge and agree that any such information that comes to the attention of Marcum in the course of performing this engagement may be considered and used by Marcum in the context of responding to its professional obligations as your independent auditors.

The working papers prepared in conjunction with our engagement are the property of Marcum LLP and constitute confidential information, subject to Florida's Public Records Law, to the extent applicable. These working papers will be retained by us in accordance with applicable laws and our Firm's policies and procedures. However, we may be required, by law or regulation, to make certain working papers available to regulatory authorities for their review, and upon request, we may be required to provide such authorities with photocopies of selected working papers.

The Firm is required to undergo a "Peer Review" every three years. During the course of a Peer Review engagement, selected working papers and financial reports, on a sample basis, will be inspected by an outside party on a confidential basis. Consequently, the accounting and/or auditing work we performed for you may be selected. Your signing this letter represents your acknowledgement and permission to allow such access should your engagement be selected for review.

As a result of our prior or future services to you, we may be required or requested to provide information or documents to you or a third-party in connection with a legal or administrative proceeding (including a grand jury investigation) in which we are not a party. If this occurs, we shall be entitled to compensation for our time and reimbursement for our reasonable out-of-pocket expenditures (including legal fees) in complying with such request or demand. This is not intended, however, to relieve us of our duty to observe the confidentiality requirements of our profession.

Third-Party Service Providers

The Firm may, from time to time, and depending on the circumstances, use third-party service providers to assist us with the audit of your financial statements. We may share confidential information about you with the third-party service providers, but remain committed to maintaining the confidentiality of your information. Accordingly, we maintain internal policies, procedures and safeguards to protect the confidentiality of your information. Furthermore, the Firm will remain responsible for the work performed by such third-party service providers.

Dispute Resolution Procedure, Waiver of Jury Trial and Jurisdiction and Venue for Any and All Disputes Under This Engagement Letter and Governing Law

AS A MATERIAL INDUCEMENT FOR US TO ACCEPT THIS ENGAGEMENT AND/OR RENDER THE SERVICES TO THE TOWN IN ACCORDANCE WITH THE PROVISIONS OF THIS ENGAGEMENT LETTER:

This Firm and the Town each hereby knowingly, voluntarily and intentionally waive any right either may have to a trial by jury with respect to any litigation based hereon, or arising out of, under or in connection with this engagement letter and/or the services provided hereunder, or any course of conduct, course of dealing, statements (whether verbal or written) or actions of either party.

This Firm and the Town each expressly agree and acknowledge that the Circuit Court of the 11th Judicial Circuit, in and for the Miami-Dade County, Florida, and the United States District Court for the Southern District of Florida, shall each have exclusive and sole jurisdiction and venue for any respective state or federal actions arising from, relating to or in connection with this engagement letter, or any course of conduct, course of dealing, statement or actions of either party arising after the date of this engagement letter.

The terms and provisions of this engagement letter, any course of conduct, course of dealing and/or action of this Firm and/or the Town and our relationship with you shall be governed by the laws of the State of Florida to the extent said laws are not inconsistent with the Federal Securities Laws and Rules, Regulations and Standards there under.

We acknowledge your right to terminate our services at any time, and you acknowledge our right to resign at any time (including instances where in our judgment, our independence has been impaired or we can no longer rely on the integrity of management), subject in either case to our right to payment for all direct and indirect charges including out-of-pocket expenses incurred through the date of termination or resignation.

You and we agree that our respective liability to the other arising out of this engagement or services provided shall not exceed the total amount paid for the services, including all direct and indirect charges and out-of-pocket expenses, described herein. This shall be the maximum monetary liability of each party to the other.

No action, regardless of form, arising out of the services under this engagement may be brought by either party more than one calendar year after the date of the last services provided under this engagement.

Subject to the provisions and monetary limitations of Section 768.28(5), Florida Statutes, which limitations shall be applicable regardless of whether such provisions would otherwise apply, and to the extent permitted by law, The Town hereby indemnifies Marcum LLP and its partners, principals, and employees, and holds them harmless from all claims, liabilities, losses, and costs arising as a direct result of a known, intentional or willful misrepresentation of fact that is provided by the Town to the Firm for a matter applicable to the services which are the subject of and being provided by the Firm under this engagement letter, regardless of whether such person was acting in the Town's interest. Firm shall indemnify and hold harmless the Town, its officers, agents and employees, from and against any and all demands, claims, losses, suits, liabilities, causes of action, judgment or damages, arising from Firm's performance or non-performance of the services which are the subject of this engagement letter and any provision of this engagement letter. Firm shall reimburse the Town for all its expenses including reasonable attorneys' fees and costs incurred in and about the defense of any such claim or investigation and for any judgment or damages arising from Firm's performance or non-performance of this engagement letter. This foregoing indemnification will survive termination of this engagement.

Other Services

We will perform, in accordance with Chapter 10.550, Rules of the Auditor General of the State of Florida, an examination pursuant to AICPA *Professional Standards*, promulgated by the American Institute of Certified Public Accountants regarding the compliance of the Town's with 218.415, Florida Statutes, Local Government Investment Policies. There is no additional cost for this service.

We are always available to meet with you and/or other management personnel at various times throughout the year to discuss current business, operational, accounting and auditing matters affecting your Organization. Whenever you feel such meetings are desirable please let us know; we are prepared to provide services to assist you in any of these areas. We will be pleased, at your request to attend your Commission meeting(s).

Timeline

Our engagement ends on delivery of our audit report. Any follow-up services that might be required will be a separate, new engagement. The terms and conditions of that new engagement will be governed by a new, specific engagement letter for that service.

Fees

Our fee for these services will be based on the actual time spent at our discounted hourly rates. Invoices shall be submitted in sufficient detail to demonstrate compliance with this engagement letter. Our discounted hourly rates vary according to the level of the personnel assigned to your engagement. Our invoices for these fees will be rendered as the work progresses, and are due and

payable upon presentation. In the event that you dispute any of the fees or expenses on a specific invoice, you agree to notify us within twenty (20) days of receipt of the invoice of such dispute. If you fail to notify us within the twenty (20) day period, your right to dispute such invoice will be waived. Prior to the commencement of the services described above, any past due balances are required to be paid in full. In accordance with our Firm policies, should any invoice remain unpaid for more than thirty days, we reserve the right to defer providing any additional services until all outstanding invoices are paid in full. Amounts past due 60 days from the invoice date will incur a finance charge of 1% per month. Nothing herein shall be construed as extending the due date of payments required under this agreement, and you agree that we are not responsible for the impact on your organization of any delay that results from such non-payment by you.

As a result of our planning process, we believe that the above described professional services can be completed for an amount not to exceed of \$62,000 (same fee as the FY 2019 audit) (excluding any federal, State or compliance audits noted below) for the fiscal year ending September 30, 2020. The estimate of our fee is based on certain assumptions, including the required assistance described above. To the extent that certain circumstances including, but not limited to those listed in Appendix A, arise during the engagement, our fee estimate may be significantly affected and additional fees may be necessary. Additional services provided beyond the described scope of services will be billed separately.

If the Town is required to undergo a single audit in accordance with the Uniform Guidance for the fiscal year ending September 30, 2020, we will discuss with you prior to commencing our procedures to arrive at a new fee estimate.

If the Town is required to undergo a single audit in accordance with the Florida Single Audit Act and Chapter 10.550 Rules of the Auditor general of the State of Florida for the fiscal year ending September 30, 2020, we will discuss with you prior to commencing our procedures to arrive at a new fee estimate.

Agreement

This letter comprises the complete and exclusive statement of the agreement between the parties, superseding all proposals oral or written and all other communications between the parties. If any provision of this letter is determined to be unenforceable, all other provisions shall remain in force.

It is hereby understood and agreed that this engagement is being undertaken solely for the benefit of the Town and that no other person or entity shall be authorized to enforce the terms of this engagement.

If you agree with the terms of our engagement, as described in this letter please sign this PDF version of the engagement letter and return it to us.

Moises D. Ariza, CPA, will serve as the audit engagement partner and is responsible for supervising the engagement and signing the report or authorizing another individual to sign it. Michael D. Futterman, CPA, will serve as the quality control director.

Town of Surfside, Florida

July 1, 2020

Page 14

This agreement is renewable at the option of the Town. We appreciate the opportunity to be of service to Town of Surfside and believe this letter accurately summarizes the significant terms of our engagement. If you have any questions, please let us know.

Very truly yours,

Marcum LLP



Moises D. Ariza, CPA, CGMA
Partner

MDA/cmk

ACCEPTED

This letter correctly sets forth the agreement of Town of Surfside, Florida

Authorized Signature: _____

Title: _____

Date Signed: _____

APPENDIX A

Town of Surfside, Florida Circumstances Affecting Timing and Fee Estimate

The estimated fee is based on certain assumptions. Circumstances may arise during the engagement that may significantly affect the targeted completion dates and our fee estimate. As a result, additional fees may be necessary. Such circumstances include but are not limited to the following:

1. Changes to the timing of the engagement at your request. Changes to the timing of the engagement usually require reassignment of personnel used by Marcum in the performance of services hereunder. However, because it is often difficult to reassign individuals to other engagements, Marcum may incur significant unanticipated costs.
2. All requested schedules are not (a) provided by the accounting personnel on the date requested, (b) completed in a format acceptable to Marcum (c) mathematically correct, or (d) in agreement with the appropriate underlying records (e.g., general ledger accounts). Marcum will provide the accounting personnel with a separate listing of required schedules and deadlines.
3. Weaknesses in the internal control.
4. Significant new issues or unforeseen circumstances as follows:
 - a. New accounting issues that require an unusual amount of time to resolve.
 - b. Changes or transactions that occur prior to the issuance of our report.
 - c. Changes in the Organization's accounting personnel, their responsibilities, or their availability.
 - d. Changes in auditing requirements set by regulators.
5. Significant delays in the accounting personnel's assistance in the engagement or delays by them in reconciling variances as requested by Marcum. All invoices, contracts and other documents which we will identify for the Organization, are not located by the accounting personnel or made ready for our easy access.
6. A significant level of proposed audit adjustments are identified during our audit.
7. Changes in audit scope caused by events that are beyond our control.
8. Untimely payment of our invoices as they are rendered.



MEMORANDUM

ITEM NO. **5B**

To: Honorable Mayor, Vice-Mayor and Members of the Town Commission
From: Jason Greene, Interim Town Manager
Date: July 14, 2020
Subject: Nurse Enhancement Initiative for School Year 2020/2021

Surfside would again be joining the neighboring communities of Miami Beach, North Bay Village, Bay Harbor Islands, and Bal Harbour, as well as the Miami Beach Chamber Education Foundation, in support of this program that benefits the students. This service is being continued at twice a week for the 2020/2021 school year.

The City of Miami Beach through the Office of Organizational Development Performance Initiatives has noted an increase in students seeking mental health support on the Nurse Enhancement Initiative at Ruth K Broad K-8 Center from 85 in school year 2018-19 to 263 in school year 2019-20 a 209% increase.

The attached resolution authorizes the execution of the Memorandum of Understanding, with an Amendment 3, for the continuation of expanded participation in the Nurse Enhancement Initiative for school year 2020/2021 in the amount of \$8,112.

Reviewed by: LA

Prepared by: JG

MIAMI BEACH

OFFICE OF THE CITY MANAGER

NO. LTC # **230-2020**

LETTER TO COMMISSION

TO: Mayor Dan Gelber and Members of the City Commission

FROM: Jimmy L. Morales, City Manager

DATE: July 1, 2020

SUBJECT: Nurse Enhancement Initiative Behavioral/Mental Health Services Summary Report

Key Metrics:

- **Number of student mental health services in 2019-20: 1,885**
- **Percent increase services from prior year Miami Beach Senior High: 144%**

The purpose of this Letter to Commission is to update the Mayor and City Commission on the status of our Nurse Enhancement Initiative for Behavioral Health/Mental Health youth support services from August 2019 through June 2020 for North Beach Elementary, Miami Beach South Pointe Elementary, Miami Beach Fienberg Fisher K-8 Center, Biscayne Beach Elementary, Treasure Island Elementary, Ruth K. Broad Bay Harbor K-8 Center, Miami Beach Nautilus Middle School, and Miami Beach Senior High School. For the 2016-17 school year, the initiative was enhanced to include behavioral health services (mental health services) to three (3) schools in the feeder pattern and was further expanded in the 2017-18 school year to an additional five (5) Miami Beach public schools.

Overall, 1,885 youth received mental health support services in the 2019-20 school year from the Licensed Clinical Social Worker (Social Worker) in all Miami Beach feeder public schools. Services were shifted to virtual in early April 2020 due to school facility closures. The below provides the number of services provided to youth per the updated reporting procedure at each Miami Beach feeder school during the 2019-20 school year:

School Name	# of youth mental health services
• Miami Beach Senior High School	785
• Miami Beach Nautilus Middle School	283*
• Miami Beach Fienberg Fisher K-8	137*
• Miami Beach South Pointe Elementary	23
• North Beach Elementary	144
• Biscayne Beach Elementary	71
• Treasure Island Elementary	179
• Ruth K. Broad K-8 Center	263

*Includes all mental health services with no more than 72 days of services through MB program 19-20

The enhanced behavioral services include on-site and virtual access to a licensed clinical social worker to provide services including, but not limited to, the following:

- Academic Issues
- Attention Issues
- Anger Management
- Anxiety
- Attention Issues
- Disruptive Behavior
- Depression
- Stress Management
- Family Issues

Each school received support through this initiative for the indicated number of days per week during the 2019-20 school year: Treasure Island Elementary one (1) day per week, North Beach Elementary two (2) days per week, Biscayne Beach Elementary two (2) days per week, Ruth K. Broad K-8 Center two (2) days per week, Miami Beach South Pointe Elementary one (1) day per week, Miami Beach Fienberg Fisher K-8 two (2) days per week, Miami Beach Nautilus Middle School three (3) days per week, and Miami Beach Senior High School five (5) days per week.

Please contact Dr. Leslie Rosenfeld, Chief Learning and Development Officer, with any questions.

MT/LDR

C: Executive Staff

Dr. Leslie Rosenfeld, Chief Learning Development Officer

**AMENDMENT NO. 3
TO THE MEMORANDUM OF UNDERSTANDING
BETWEEN
THE CITY OF MIAMI BEACH, NORTH BAY VILLAGE, THE TOWN OF BAY HARBOR
ISLANDS, THE TOWN OF SURFSIDE, BAL HARBOUR VILLAGE, AND
THE MIAMI BEACH CHAMBER EDUCATION FOUNDATION TO IMPLEMENT A
NURSE ENHANCEMENT INITIATIVE FOR SCHOOL YEAR 2020/2021**

Amendment No. 3 (“**Amendment**”) is made and entered into this ____ day of _____, 2020, by and between the **City of Miami Beach, Florida**, a municipal corporation organized and existing under the laws of the State of Florida, having its principal place of business at 1700 Convention Center Drive, Miami Beach, Florida 33139 (“**CMB**”), **North Bay Village** (“**NBV**”), the **Town of Bay Harbor Islands** (“**TBHI**”), the **Town of Surfside** (“**TS**”), **Bal Harbour Village** (“**BHV**”), and the **Miami Beach Chamber Education Foundation, Inc.** (“**MBCEF**”) (collectively, the “**Parties**”) to amend the Memorandum of Understanding entered into on May 17, 2018 (“**MOU**”), as amended by Amendment No. 1 to the **MOU**, dated December 24, 2018 and as amended by Amendment No. 2 to the **MOU**, dated September 19, 2019 (collectively, the “**MOU**”), as follows:

RECITALS

WHEREAS, the Parties have determined that a program to provide healthcare services to students attending underserved public schools is in the best interests of the health and public welfare of the City of Miami Beach, North Bay Village, the Town of Bay Harbor Islands, the Town of Surfside, and Bal Harbour Village (the “**Participating Municipalities**”); and

WHEREAS, following the Parties’ determination that students at Miami Beach North Beach Elementary, Treasure Island Elementary, and Ruth K. Broad Bay Harbor K-8 Center (the “**Participating Schools**”) did not have full-time on-site healthcare services and were, thus, underserved as compared to other public schools in the feeder pattern that falls within the City of Miami Beach, the Parties entered into a Memorandum of Understanding on August 19, 2013 for a Nurse Initiative, and another Memorandum of Understanding on April 23, 2014, to provide healthcare services to the **Participating Schools** during the 2013/2014 and the 2014/2015 School Years; and

WHEREAS, due to the success of Nurse Initiatives during the 2013/2014 and 2014/2015 School Years, the Parties implemented an enhanced nurse initiative (“**Nurse Enhancement Initiative**”) for the 2015/2016, 2016/2017, and the 2017/2018 School Years for the **Participating Schools** because the basic healthcare services previously funded in the Nurse Initiative by the **Participating Municipalities**, the **MBCEF**, and the Children’s Trust (“**TCT**”), were provided by **TCT** via the new School Health Programs; and

WHEREAS, on May 17, 2018, **CMB, NBV, TBHI, TS, BHV**, and **MBCEF** executed the **MOU** for the continuation of the **Nurse Enhancement Initiative** for the **Participating Schools** for the 2018-2019 School Year; and

WHEREAS, the Parties executed Amendment No. 1 to the **MOU**, dated December 24, 2018, adding an additional day of service at Ruth K. Broad Bay Harbor K-8 Center; and

WHEREAS, on September 11, 2019, the Mayor and City Commission adopted Resolution No. 2019-30956, approving Amendment No. 2 to the **MOU** and approving funding of **CMB's** contribution for each subsequent school year, on a recurring basis, subject to funding approval during **CMB's** budgetary process and provided that **CMB's** contribution amount does not exceed \$15,400.00; and

WHEREAS, the Parties executed Amendment No. 2 to the **MOU**, dated September 19, 2019, extending the **Nurse Enhancement Initiative** for the **Participating Schools** for the 2019-20 School Year; and

WHEREAS, the Parties wish to provide for another **Nurse Enhancement Initiative** for the 2020/2021 School Year; and

WHEREAS, a **Nurse Enhancement Initiative** should be established at the **Participating Schools** for School Year 2020/2021 as herein provided and pursuant to a separate agreement between **MBCEF** and **TCT**.

WHEREAS, **MBCEF** shall provide funding to **TCT** for the 2020-2021 **Nurse Enhancement Initiative** in the amount of \$7,000.00.

NOW, THEREFORE, in consideration of the mutual conditions and promises contained herein, the Parties agree to amend the **MOU** as follows:

1. ABOVE RECITALS.

The above recitals are true and correct and are incorporated as part of this Amendment.

2. MODIFICATIONS.

Paragraph 3 of the **MOU** is hereby deleted in its entirety and replaced with the following:

- 3. On or before October 31, 2020 the Participating Municipalities shall provide their proportionate share of the funds for the 2020/21 Nurse Enhancement Initiative to MBCEF, subject to budget approval by the Participating Municipalities, which funds MBCEF shall hold in escrow pending the execution of its agreement with TCT referenced in paragraph 1. The**

Participating Municipalities proportionate share of funding for the 2020/21 School Year shall be paid by October 31, 2020 in the following amounts for 44 weeks from October 1, 2020 to June 5th 2021, and August 1, 2021 to September 30, 2021:

- i) CMB shall provide funding in the amount of \$15,400;
- ii) NBV shall provide funding in the amount of \$6,600
- iii) TBHI shall provide funding in the amount of \$8,112 for 2 days of service at Ruth K. Broad Bay Harbor K-8 Center;
- iv) TS shall provide funding in the amount of \$8,112 for 2 days of service at Ruth K. Broad Bay Harbor K-8 Center;
- v) BHV shall provide funding in the amount of \$8,112 for 2 days of service at Ruth K. Broad Bay Harbor K-8 Center;

4. RATIFICATION.

Except as amended herein, all other terms and conditions of the **MOU** shall remain in full force and effect. In the event there is a conflict between the provisions of this **Amendment** and the **MOU**, the provisions of this **Amendment** shall govern.

(THE REMAINDER OF THIS PAGE HAS BEEN INTENTIONALLY LEFT BLANK)

IN WITNESS THEREOF, the Parties hereto have executed by their respective and duly authorized officers the day and year first above written.

ATTEST:

CITY OF MIAMI BEACH, a Municipal Corporation of the State of Florida

By: _____
Rafael E. Granado, City Clerk

By: _____
Jimmy L. Morales, City Manager

Date: _____

APPROVED AS TO
FORM & LANGUAGE
& FOR EXECUTION



City Attorney

6/9/2022
Date

ATTEST:

NORTH BAY VILLAGE, a Municipal
Corporation of the State of Florida

By: _____
Village Clerk

By: _____
Village Manager

Date: _____

Approved as to form and
Legal sufficiency

ATTEST:

TOWN OF BAY HARBOR ISLANDS, a Municipal Corporation of the State of Florida

By: _____
Town Clerk

By: _____
Mayor/Town Manager

Date: _____

Approved as to form and
Legal sufficiency

ATTEST:

TOWN OF SURFSIDE, a Municipal Corporation of the State of Florida

By: _____
Town Clerk

By: _____
Mayor/Town Manager

Date: _____

Approved as to form and
Legal sufficiency

ATTEST:

BAL HARBOUR VILLAGE, a Municipal Corporation of the State of Florida

By: _____
Village Clerk

By: _____
Mayor/Village Manager

Date: _____

Approved as to form and
Legal sufficiency

ATTEST:

**MIAMI BEACH CHAMBER EDUCATION
FOUNDATION**

By: _____

By: _____

Date: _____

RESOLUTION NO. 2019-30956

A RESOLUTION OF THE MAYOR AND CITY COMMISSION OF THE CITY OF MIAMI BEACH, FLORIDA, APPROVING, IN THE FORM ATTACHED TO THIS RESOLUTION, AMENDMENT NO. 2 TO THE MEMORANDUM OF UNDERSTANDING ("MOU"), DATED AUGUST 10, 2016, AMONG THE CITY, THE MIAMI BEACH CHAMBER OF COMMERCE, NORTH BAY VILLAGE, THE TOWN OF BAY HARBOR ISLANDS, THE TOWN OF SURFSIDE, AND BAL HARBOUR VILLAGE FOR THE FUNDING OF MENTAL HEALTH SERVICES, PROVIDING FOR A CITY CONTRIBUTION, IN AN AMOUNT NOT TO EXCEED \$13,887 ("CITY'S CONTRIBUTION") FOR THE 2019-2020 SCHOOL YEAR; AND APPROVING FUNDING OF THE CITY'S CONTRIBUTION FOR EACH SUBSEQUENT SCHOOL YEAR, ON A RECURRING BASIS, SUBJECT TO FUNDING APPROVAL DURING THE CITY'S BUDGETARY PROCESS AND PROVIDED THAT THE CITY'S CONTRIBUTION AMOUNT DOES NOT EXCEED \$15,400; AND FURTHER AUTHORIZING THE CITY MANAGER AND CITY CLERK TO EXECUTE ANY AND ALL REQUIRED AGREEMENTS AND DOCUMENTS TO IMPLEMENT THE PROGRAM.

WHEREAS, in January 2008, the City of Miami Beach (the "City") entered into an Education Compact with the Miami-Dade County Public Schools ("MDCPS") to enhance learning opportunities for youth; and

WHEREAS, the Education Compact reflects the desire of the Miami Beach community to support excellence in the City's public schools and enhance the health and well-being of our City's youth; and

WHEREAS, as a result of the City's Education Compact with MDCPS, all public schools in Miami Beach offer the International Baccalaureate program which is internationally recognized as a benchmark for education excellence and also fosters student participation in community service; and

WHEREAS, in the 2012-2013 School Year, five of the eight schools in our educational feeder pattern had Health Connect in Our Schools ("HCIOS") suites which were supported by The Children's Trust ("The Trust") and which provided a full-time Medical Assistant and a shared Registered Nurse on campus; and

WHEREAS, for students who do not require routine medications, the HCIOS suites were used for nursing assessments, administration of first aid, and other purposes such as consulting with parents and caregivers; and

WHEREAS, the City, North Bay Village, the Town of Bay Harbor Islands, the Town of Surfside, and Bal Harbour Village ("Participating Municipalities") determined that a program to provide healthcare services to students attending underserved public schools is in the best interests of the health and public welfare of youth; and

WHEREAS, in the 2013-2014 School Year, a municipal Nurse Initiative was implemented pursuant to a Memorandum of Understanding between the Participating Municipalities to provide a HCIOS team of professionals, including a shared Registered Nurse, a full-time Medical Assistant, and a social worker which was funded by Miami-Dade County Public Schools; and

WHEREAS, the benefits of HCIOS health teams include: a coordinated level of school-based healthcare, expanded health screenings, and assessments with access to follow-up care, mental and behavioral health services to identify and solve student health and educational issues, nutrition and health counseling, health services for uninsured students with no other option for access to health care, emergency first aid/CPR, and chronic disease management; and

WHEREAS, utilization of the HCIOS remained high throughout the 2014-2015 School Year, with 52 percent of the 3,044 unduplicated students utilizing the services from August 2014 through February 2015, an average of eleven visits per day per school resulting in 3,836 visits; and

WHEREAS, by approval of Resolution 2015-42 on February 9, 2015, The Trust's Board of Directors approved the release of RFP 2015-17: School Health Programs to fund improved access to quality health care through providers delivering comprehensive services in the public schools to 145 pre-selected schools for School Years 2015-2016, 2016-2017, and 2017-2018; the programs which are the subject of the RFP include all three (3) Miami Beach schools in the City's original Nurse Initiative; and

WHEREAS, due to the success of the Nurse Initiative during the 2013-2014 and 2014-2015 School Years, the Parties implemented an enhanced Nurse Initiative ("Nurse Enhancement Initiative") for 2015-2016 and the 2016-2017 School Years for the Participating Schools because the basic healthcare services previously funded in the Nurse Initiative by the Participating Municipalities, the Miami Beach Chamber Education Foundation, Inc., and The Trust, were provided by The Trust via the new School Health Programs; and

WHEREAS, the Nurse Enhancement Initiative established at the Participating Schools for School Years 2015-2016 and 2016-2017 was a success and the Parties provided for an enhanced nurse initiative for the 2017-2018 School Year; and

WHEREAS, the City's proportionate share for the Nurse Enhancement Initiative was approximately \$15,400 for the 2017-2018 School Year; and

WHEREAS, The Trust thereafter committed to fund the School Health Programs at all Miami Beach feeder schools through the end of the 2017-2018 School Year; and

WHEREAS, the funding provided by the Participating Municipalities enhanced The Trust's School Health Programs for North Beach Elementary, Treasure Island Elementary, and Ruth K. Broad Bay Harbor K-8 Center (the "Schools"), to include services such as behavioral health each week during the 2017-2018 School Year at each of the Schools; and

WHEREAS, funding from The Trust provided for a full-time registered nurse and/or licensed practical nurse at each of the Schools for the 2017-2018 School Year; and

WHEREAS, each of the Participating Municipalities contributed approximate funding for the Nurse Enhancement Initiative for the 2017-2018 School Year, as follows: City of Miami Beach \$15,400, Town of Surfside \$3,667, Town of Bay Harbor Islands \$3,667, Bal Harbour Village \$3,667, and North Bay Village \$6,600, which amounts will be offset by unused funds from the 2016-2017 Nurse Enhancement Initiative for the Town of Surfside, the Town of Bay Harbor Islands, Bal Harbour Village, and North Bay Village; and

WHEREAS, on May 17, 2018, a Memorandum of Understanding ("MOU") was entered into between the City of Miami Beach, the Miami Beach Chamber of Commerce, North Bay Village, the Town of Surfside, the Town of Bay Harbor Islands, and Bal Harbour Village, with the Participating Municipalities contributing their proportionate share of the costs to support the Nurse Enhancement Initiative program for the 2018-2019 School Year; and

WHEREAS, on December 24, 2018, the Participating Municipalities executed Amendment No.1 to the 2018-2019 MOU, each of the Participating Municipalities contributing funding for the Nurse Enhancement Initiative for the 2018-2019 School Year; and

WHEREAS, the Administration recommends approving Amendment No. 2 to the MOU, in the form attached to this Resolution, approving a City contribution in an amount not to exceed \$13,887 ("City Contribution") for the 2019-2020 School Year, and approving, on a recurring basis, the City's Contribution to the program for subsequent years, subject to funding approval during the City's fiscal year budgetary process, provided that the City Contribution does not exceed \$15,400 per year.

NOW, THEREFORE, BE IT DULY RESOLVED BY THE MAYOR AND THE CITY COMMISSION OF THE CITY OF MIAMI BEACH, FLORIDA that the Mayor and City Commission hereby approve, in the form attached to this Resolution, Amendment No. 2 to the Memorandum of Understanding ("MOU"), dated August 10, 2016, among the City of Miami Beach, the Miami Beach Chamber of Commerce, North Bay Village, the Town of Bay Harbor Islands, the Town of Surfside, and Bal Harbour Village for the funding of mental health services, providing for a City contribution, in an amount not to exceed \$13,887 ("City's Contribution") for the 2019-2020 school year; and approving funding of the City's Contribution for each subsequent school year, on a recurring basis, subject to funding approval during the City's budgetary process and provided that the City's Contribution amount does not exceed \$15,400; and further authorizing the City Manager

and City Clerk to execute any and all required agreements and documents to implement the program.

PASSED AND ADOPTED this 11th day of September 2019

ATTEST:

9/16/19
Rafael E. Granado, City Clerk

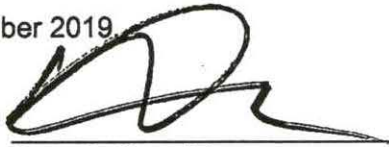
Dan Gelber, Mayor



APPROVED AS TO
FORM & LANGUAGE
& FOR EXECUTION

City Attorney
8/29/19
Date
FB

MIAMI BEACH

COMMISSION MEMORANDUM

TO: Honorable Mayor and Members of the City Commission
FROM: Jimmy L. Morales, City Manager
DATE: September 11, 2019

SUBJECT: A RESOLUTION OF THE MAYOR AND CITY COMMISSION OF THE CITY OF MIAMI BEACH, FLORIDA, APPROVING, IN THE FORM ATTACHED TO THIS RESOLUTION, AMENDMENT NO. 2 TO THE MEMORANDUM OF UNDERSTANDING ("MOU"), DATED AUGUST 10, 2016, AMONG THE CITY, THE MIAMI BEACH CHAMBER OF COMMERCE, NORTH BAY VILLAGE, THE TOWN OF BAY HARBOR ISLANDS, THE TOWN OF SURFSIDE, AND BAL HARBOUR VILLAGE FOR THE FUNDING OF MENTAL HEALTH SERVICES, PROVIDING FOR A CITY CONTRIBUTION, IN AN AMOUNT NOT TO EXCEED \$13,887 ("CITY'S CONTRIBUTION") FOR THE 2019-2020 SCHOOL YEAR; AND APPROVING FUNDING OF THE CITY'S CONTRIBUTION FOR EACH SUBSEQUENT SCHOOL YEAR, ON A RECURRING BASIS, SUBJECT TO FUNDING APPROVAL DURING THE CITY'S BUDGETARY PROCESS AND PROVIDED THAT THE CITY'S CONTRIBUTION AMOUNT DOES NOT EXCEED \$15,400; AND FURTHER AUTHORIZING THE CITY MANAGER AND CITY CLERK TO EXECUTE ANY AND ALL REQUIRED AGREEMENTS AND DOCUMENTS TO IMPLEMENT THE PROGRAM.

RECOMMENDATION

Sustain the Nurse Enhancement Initiative for Behavioral Health Services / Mental Health Services and support the partnership for the 2019-20 school year and subsequent school years subject to approval in each subsequent fiscal year budgetary process.

ANALYSIS

The Nurse Enhancement Initiative for Behavioral Health is a partnership between the City of Miami Beach, Miami Beach Chamber of Commerce, North Bay Village, The Town of Surfside, The Town of Bay Harbor Islands, and Bal Harbour Village, that provides much needed mental health services for youth at three (3) public schools. For the 2016-17 school years, the initiative was enhanced to include behavioral health services (mental health services) to three (3) schools in the feeder pattern and was further expanded in the 2017-18 school year to an additional five (5) Miami Beach public schools. For the 2018-19 school year behavioral health/mental health youth support services were provided from August 2018 through June 2019 for North Beach Elementary, South Pointe Elementary, Fienberg Fisher K-8 Center, Biscayne Elementary, Treasure Island Elementary, Ruth K. Broad Bay Harbor K-8 Center, Nautilus Middle School, and Miami Beach Senior High School.

Overall, 2,105 youth received support services in the 2018-19 school year from the Licensed Clinical Social Workers (Social Worker) in all Miami Beach feeder public schools for 5,426 psychosocial issues an

increase of 49% and 65%, respectively. The chart below shows the utilization of students by school and number of psychosocial services provided to date:

Behavioral Health Services Summary Report						
8/21/2018 - 4/30/2019						
School	# of Students 2017-18	# of Students 2018-19	% Change	# of Psychosocial Services Provided 2017-18	# of Psychosocial Services Provided 2018-19	% Change
Treasure Island Elementary School	52	174	235%	293	362	24%
South Pointe Elementary School	115	303	163%	197	465	136%
North Beach Elementary School	126	254	102%	439	398	-9%
Biscayne Elementary School	111	176	59%	428	868	103%
Ruth K. Broad K-8 Center	84	85	1%	124	196	58%
Fienberg Fisher K-8 Center	277	216	-22%	381	482	27%
Nautilus Middle School	474	582	23%	1150	1934	68%
Miami Beach Senior High School	177	315	78%	284	721	154%
Total	1,416	2,105	49%	3,296	5,426	65%

The enhanced behavioral services include on-site access to a licensed clinical social worker to provide services including, but not limited to, the following:

- o Academic Issues
- o Attention Issues
- o Anger Management
- o Anxiety
- o Attention Issues
- o Disruptive Behavior
- o Depression
- o Stress Management
- o Family Issues
- o Growth Development

Each school receives support through this initiative for the indicated number of days per week during the 2018-19 school year: Treasure Island Elementary one (1) day per week, North Beach Elementary two (2) days per week, Biscayne Elementary two (2) days per week, Ruth K. Broad K-8 Center two (2) days per week, South Pointe Elementary two (2) days per week, Fienberg Fisher K-8 Center three (3) days per week, Nautilus Middle School two (2) days per week, Miami Beach Senior High School two (2) days per week.

week, South Pointe Elementary two (2) days per week, Flenberg Fisher K-6 Center three (3) days per week, Nautilus Middle School three (3) days per week, and Miami Beach Senior High School four (4) days per week.

Legislative Tracking

Organizational Development and Performance Initiatives

ATTACHMENTS:

Description

- Form Approved Amendment 2
- Form Approved Resolution

**AMENDMENT NO. 2
TO THE MEMORANDUM OF UNDERSTANDING
BETWEEN
THE CITY OF MIAMI BEACH, NORTH BAY VILLAGE, THE TOWN OF BAY HARBOR
ISLANDS, THE TOWN OF SURFSIDE, BAL HARBOUR VILLAGE, AND
THE MIAMI BEACH CHAMBER EDUCATION FOUNDATION, INC TO IMPLEMENT A
NURSE ENHANCEMENT INITIATIVE FOR SCHOOL YEAR 2019/2020**

Amendment No. 2 ("**Amendment**") is made and entered into this 19 day of ~~SEPT~~ SEPT, 2019, by and between the **City of Miami Beach, Florida**, a municipal corporation organized and existing under the laws of the State of Florida, having its principal place of business at 1700 Convention Center Drive, Miami Beach, Florida 33139 ("**CITY**"), **North Bay Village ("NBV")**, the **Town of Bay Harbor Islands ("TBHI")**, the **Town of Surfside ("TS")**, **Bal Harbour Village ("BHV")**, and the **Miami Beach Chamber Education Foundation, Inc. ("MBCEF")** (collectively, the "**Parties**") to amend the Memorandum of Understanding entered into on May 17, 2018 ("**MOU**"), as amended by Amendment No. 1 to the MOU, dated December 24, 2018 (collectively, the "**MOU**"), as follows:

RECITALS

WHEREAS, the Parties have determined that a program to provide healthcare services to students attending underserved public schools is in the best interests of the health and public welfare of the City of Miami Beach, North Bay Village, the Town of Bay Harbor Islands, the Town of Surfside, and Bal Harbour Village (the "**Participating Municipalities**"); and

WHEREAS, following the Parties' determination that students at North Beach Elementary, Treasure Island Elementary, and Ruth K. Broad Bay Harbor K-8 Center (the "**Participating Schools**") did not have full-time on-site healthcare services and were, thus, underserved as compared to other public schools in the feeder pattern that falls within the City of Miami Beach, the Parties entered into a Memorandum of Understanding on August 19, 2013 for a Nurse Initiative, and another Memorandum of Understanding on April 23, 2014, to provide healthcare services to the **Participating Schools** during the 2013/2014 and the 2014/2015 School Years; and

WHEREAS, due to the success of Nurse Initiative during the 2013/2014 and 2014/2015 School Years, the Parties implemented an enhanced nurse initiative ("Nurse Enhancement Initiative") for the 2015/2016, 2016/2017, and the 2017/2018 School Years for the **Participating Schools** because the basic healthcare services previously funded in the Nurse Initiative by the **Participating Municipalities**, the **MBCEF**, and the Children's Trust, were provided by the Children's Trust via the new School Health Programs; and

WHEREAS, the Parties executed Amendment No. 1 to the MOU, dated December 24, 2018, extending the Nurse Enhancement Initiative for the Participating

Schools for the 2018-2019 School Year and adding an additional day of service at Ruth K Broad Bay Harbor K-8 Center; and

WHEREAS, the Nurse Enhancement Initiative established at the **Participating Schools** for the previous School Years was a success and the Parties wish to continue the Nurse Enhancement Initiative for the 2019/2020 School Year; and

WHEREAS, at the end of the 2018-2019 School Year, the Participating Municipalities unused program funds had the following:

- i) TBHI \$5,473.05
- ii) TS \$5,473.02
- iii) BHV \$5,473.02
- iv) NBV \$2,002.72
- v) CMB \$4,673.00; and

WHEREAS, the Participating Municipalities hereby agree to apply said unused funds for use from August 5th, 2019 to September 30th, 2019 for 9 weeks of service at each Participating School in the following amounts:

- i) TBHI \$1,659.27
- ii) TS \$1,659.27
- iii) BHV \$1,659.27
- iv) NBV \$1,350.00
- v) CMB \$3,150.00
 - a. \$900.00 for Treasure Island
 - b. \$2,250.00 for North Beach Elementary; and

WHEREAS, pursuant to paragraph 7 of the **MOU**, unused funds shall be used to offset the contribution of the Parties for the 2019-2020 School Year in the following amounts:

- i) TBHI \$3,813.78
- ii) TS \$3,813.78
- iii) BHV \$3,813.78
- iv) NBV \$652.72
- v) CMB \$1,523.00; and

WHEREAS, **MBCEF** shall provide funding to **TCT** for the 2019-2020 Nurse Enhancement Initiative in the amount of \$7,000.00; and

WHEREAS, the Parties wish to amend the Agreement by extending the term to include the months of August and September, 2020; and

WHEREAS, a Nurse Enhancement Initiative should be established at the Participating Schools for School Year 2019/2020 as herein provided and pursuant to a separate agreement to be entered into between **MBCEF** and **TCT**.

NOW, THEREFORE, in consideration of the mutual conditions and promises contained herein, the Parties agree to amend the **MOU** as follows:

1. ABOVE RECITALS.

The above recitals are true and correct and are incorporated as part of this Amendment.

2. MODIFICATIONS.

Paragraph 3 of the **MOU** is hereby deleted in its entirety and replaced with the following:

3. On or before October 31, 2019 the Participating Municipalities shall provide their proportionate share of funds for the 2019/2020 Nurse Enhancement Initiative to MBCEF, subject to budget approval by the Participating Municipalities, which funds MBCEF shall hold in escrow pending the execution of its agreement with TCT referenced in paragraph 1. The Participating Municipalities proportionate remaining share of funding for the 2019/2020 School Year shall be paid by October 31, 2019 in the following amounts for 44 weeks from October 1st, 2019 to June 5th, 2020, and August 1st, 2020 to September 30th, 2020:

- i) CMB shall provide funding in the amount of \$13,887.00;
- ii) NBV shall provide funding in the amount of \$5,947.28;
- iii) TBHI shall provide funding in the amount of \$4,298.22 for 2 days of service at Ruth K. Broad Bay Harbor K-8 Center;
- iv) TS shall provide funding in the amount of \$4,298.22 for 2 days of service at Ruth K. Broad Bay Harbor K-8 Center; and
- v) BHV shall provide funding in the amount of \$4,298.22 for 2 days of service at Ruth K. Broad Bay Harbor K-8 Center.

4. RATIFICATION.

Except as amended herein, all other terms and conditions of the **MOU** shall remain in full force and effect. In the event there is a conflict between the provisions of this **Amendment** and the **MOU**, the provisions of this **Amendment** shall govern.

IN WITNESS THEREOF, the Parties hereto have executed by their respective and duly authorized officers the day and year first above written.

ATTEST:

CITY OF MIAMI BEACH, a Municipal Corporation of the State of Florida

By:  9/19/19
Rafael E. Granado, City Clerk

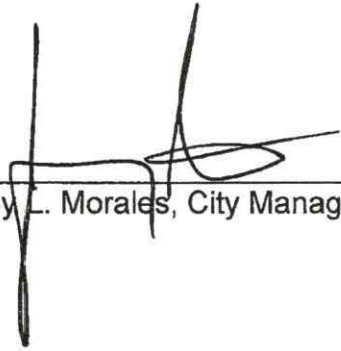
By: 
Jimmy L. Morales, City Manager

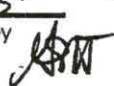

APPROVED AS TO
FORM & LANGUAGE
& FOR EXECUTION

 6-10-19
City Attorney Date

ATTEST:

NORTH BAY VILLAGE, a Municipal
Corporation of the State of Florida

By: 
Village Clerk

By: 
Village Manager

Approved as to form and
Legal sufficiency



ATTEST:

TOWN OF BAY HARBOR ISLANDS, a Municipal Corporation of the State of Florida

By: [Signature]
Town Clerk

By: [Signature]
Mayor/Town Manager

Approved as to form and
Legal sufficiency

[Signature]
Asst Town Atty

ATTEST:

By: _____
Town Clerk

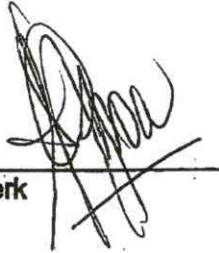

**TOWN OF SURFSIDE, a Municipal
Corporation of the State of Florida**

By: _____
Mayor/Town Manager



Approved as to form and
Legal sufficiency



ATTEST:

By: _____
Village Clerk

BAL HARBOUR VILLAGE, a Municipal Corporation of the State of Florida

By:  _____
Mayor/Village Manager

Approved as to form and
Legal sufficiency



Susan M. Martin

ATTEST:

**MIAMI BEACH CHAMBER EDUCATION
FOUNDATION**

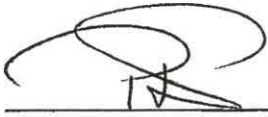
By:  _____

By:  _____

Approved as to form and
Legal sufficiency

**AMENDMENT NO. 1
TO THE MEMORANDUM OF UNDERSTANDING
BETWEEN
THE CITY OF MIAMI BEACH, NORTH BAY VILLAGE, THE TOWN OF BAY HARBOR
ISLANDS, THE TOWN OF SURFSIDE, BAL HARBOUR VILLAGE, AND
THE MIAMI BEACH CHAMBER EDUCATION FOUNDATION TO IMPLEMENT A
NURSE ENHANCEMENT INITIATIVE FOR SCHOOL YEAR 2018/2019**

Amendment No. 1 ("**Amendment**") is made and entered into this 24 day of ~~December~~, 2018, by and between the **City of Miami Beach, Florida**, a municipal corporation organized and existing under the laws of the State of Florida, having its principal place of business at 1700 Convention Center Drive, Miami Beach, Florida 33139 ("**CITY**"), **North Bay Village ("NBV")**, the **Town of Bay Harbor Islands ("TBHI")**, the **Town of Surfside ("TS")**, **Bal Harbour Village ("BHV")**, and the **Miami Beach Chamber Education Foundation, Inc. ("MBCEF")** (collectively, the "**Parties**") to amend the Memorandum of Understanding entered into on May 17, 2018 ("**MOU**") as follows:

RECITALS

WHEREAS, the Parties have determined that a program to provide healthcare services to students attending underserved public schools is in the best interests of the health and public welfare of the City of Miami Beach, North Bay Village, the Town of Bay Harbor Islands, the Town of Surfside, and Bal Harbour Village (the "**Participating Municipalities**"); and

WHEREAS, following the Parties' determination that students at North Beach Elementary, Treasure Island Elementary, and Ruth K. Broad Bay Harbor K-8 Center (the "**Participating Schools**") did not have full-time on-site healthcare services and were, thus, underserved as compared to other public schools in the feeder pattern that falls within the City of Miami Beach, the Parties entered into a Memorandum of Understanding on August 19, 2013 for a Nurse Initiative, and another Memorandum of Understanding on April 23, 2014, to provide healthcare services to the **Participating Schools** during the 2013/2014 and the 2014/2015 School Years; and

WHEREAS, due to the success of Nurse Initiatives during the 2013/2014 and 2014/2015 School Years, the Parties implemented an enhanced nurse initiative ("**Nurse Enhancement Initiative**") for the 2015/2016, 2016/2017, and the 2017/2018 School Years for the **Participating Schools** because the basic healthcare services previously funded in the Nurse Initiative by the **Participating Municipalities**, the **MBCEF**, and the Children's Trust, were provided by the Children's Trust via the new School Health Programs, and

WHEREAS, the Nurse Enhancement Initiative established at the **Participating Schools** for School Years 2015/2016, 2016/2017, and 2017/2018 was a success and the Parties wish to provide for another nurse enhancement initiative for the 2018/2019 School Year; and

WHEREAS, a Nurse Enhancement Initiative should be established at the Participating Schools for School Year 2018/2019 as herein provided and pursuant to a separate agreement to be entered into between **MBCEF** and **TCT**.

NOW, THEREFORE, in consideration of the mutual conditions and promises contained herein, the Parties agree to amend the **MOU** as follows:

1. ABOVE RECITALS.

The above recitals are true and correct and are incorporated as part of this Amendment.

2. MODIFICATIONS.

The **MOU** is hereby amended (deleted items ~~struck through~~ and inserted items underlined) as follows:

(a) Paragraph 3 of the **MOU** is hereby amended and replaced with the following:

1. On or before October 31, 2018, the **Participating Municipalities** shall provide their proportionate share of funds for the 2018/2019 Nurse Enhancement Initiative to **MBCEF**, subject to budget approval by the **Participating Municipalities**, which funds **MBCEF** shall hold in escrow pending the execution of its agreement with **TCT** referenced in paragraph 1. The **Participating Municipalities'** proportionate remaining share of funding for the 2018/2019 School Year shall be paid by October 31, 2018 in the following amounts:

- i) **CMB** shall provide funding in the amount of \$15,400.00;
- ii) **NBV** shall provide funding in the amount of \$6,600.00;
- iii) **TBHI** shall provide funding in the amount of ~~\$3,667.00~~ \$8,112 for 2 days of service at Ruth K. Broad Bay Harbor K-8 Center;
- iv) **TS** shall provide funding in the amount of ~~\$3,667.00~~ \$8,112 for 2 days of service at Ruth K. Broad Bay Harbor K-8 Center;
- v) **BHV** shall provide funding in the amount of ~~\$3,667.00~~ \$8,112 for 2 days of service at Ruth K. Broad Bay Harbor K-8 Center;

3. **RATIFICATION.**

Except as amended herein, all other terms and conditions of the **MOU** shall remain in full force and effect. In the event there is a conflict between the provisions of this **Amendment** and the **MOU**, the provisions of this **Amendment** shall govern.

(THE REMAINDER OF THIS PAGE HAS BEEN INTENTIONALLY LEFT BLANK)

IN WITNESS THEREOF, the Parties hereto have executed by their respective and duly authorized officers the day and year first above written.

ATTEST:

CITY OF MIAMI BEACH, a Municipal Corporation of the State of Florida

By: 
Rafael E. Granado, City Clerk

By: 
Dan Gelber, Mayor



APPROVED AS TO
FORM & LANGUAGE
& FOR EXECUTION

City Attorney

18-3-18
Date

ATTEST:

NORTH BAY VILLAGE, a Municipal Corporation of the State of Florida

By: 
Village Clerk

By: 
Village Manager

Approved as to form and
Legal sufficiency





ATTEST:

TOWN OF BAY HARBOR ISLANDS, a Municipal Corporation of the State of Florida

By: 
Town Clerk

By: 
Mayor/Town Manager

Approved as to form and
Legal sufficiency

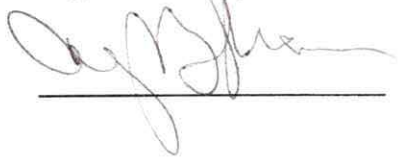

ATTEST:

By: 
Town Clerk

TOWN OF SURFSIDE, a Municipal Corporation of the State of Florida

By: 
Mayor/Town Manager

Approved as to form and
Legal sufficiency



ATTEST:

BAL HARBOUR VILLAGE, a Municipal Corporation of the State of Florida

By: 
Village Clerk

By: 
Mayor/Village Manager

Approved as to form and
Legal sufficiency



More - Nurse Enhancement

ATTEST:

MIAMI BEACH CHAMBER EDUCATION
FOUNDATION

By: _____

By: *Jerry Blinn, President + CEO*

Approved as to form and
Legal sufficiency

**MEMORANDUM OF UNDERSTANDING BETWEEN
THE CITY OF MIAMI BEACH, NORTH BAY VILLAGE, THE TOWN OF BAY HARBOR
ISLANDS, THE TOWN OF SURFSIDE, BAL HARBOUR VILLAGE, AND
THE MIAMI BEACH CHAMBER EDUCATION FOUNDATION TO IMPLEMENT A
NURSE ENHANCEMENT INITIATIVE FOR SCHOOL YEAR 2018/2019**

This is a Memorandum of Understanding ("MOU") made and entered into this 17 day of MAY, 2018, by and between the **City of Miami Beach ("CMB")**, **North Bay Village ("NBV")**, the **Town of Bay Harbor Islands ("TBHI")**, the **Town of Surfside ("TS")**, **Bal Harbour Village ("BHV")**, and the **Miami Beach Chamber Education Foundation, Inc. ("MBCEF")** (collectively, the "Parties") to provide for funding and for the implementation of a Nurse Enhancement Initiative as provided herein, and as to be provided in an agreement between **MBCEF** and **The Children's Trust ("TCT")**.

WITNESSETH

WHEREAS, the Parties have determined that a program to provide healthcare services to students attending underserved public schools is in the best interests of the health and public welfare of the City of Miami Beach, North Bay Village, the Town of Bay Harbor Islands, the Town of Surfside, and Bal Harbour Village (the "**Participating Municipalities**"); and

WHEREAS, following the Parties' determination that students at North Beach Elementary, Treasure Island Elementary, and Ruth K. Broad Bay Harbor K-8 Center (the "**Participating Schools**") did not have full-time on-site healthcare services and were, thus, underserved as compared to other public schools in the feeder pattern that falls within the City of Miami Beach, the Parties entered into a Memorandum of Understanding on August 19, 2013 for a Nurse Initiative, and another Memorandum of Understanding on April 23, 2014, to provide healthcare services to the **Participating Schools** during the 2013/2014 and the 2014/2015 School Years; and

WHEREAS, due to the success of Nurse Initiatives during the 2013/2014 and 2014/2015 School Years, the Parties implemented an enhanced nurse initiative ("Nurse Enhancement Initiative") for the 2015/2016, 2016/2017, and the 2017/2018 School Years for the Participating Schools because the basic healthcare services previously funded in the Nurse Initiative by the Participating Municipalities, the Miami Beach Chamber Education Foundation, Inc., and the Children's Trust, were provided by the Children's Trust via the new School Health Programs, and

WHEREAS, the Nurse Enhancement Initiative established at the **Participating Schools** for School Years 2015/2016, 2016/2017, and 2017/2018 was a success and the Parties wish to provide for another nurse enhancement initiative for the 2018/2019 School Year; and

WHEREAS, a Nurse Enhancement Initiative should be established at the Participating Schools for School Year 2018/2019 as herein provided and pursuant to a separate agreement to be entered into between **MBCEF** and **TCT**.

NOW, THEREFORE, in consideration of the mutual terms, conditions, promises, covenants, and payments hereinafter set forth, the Parties agree to provide for a Nurse Enhancement Initiative for the Participating Schools during the 2018/2019 School Year as follows:

1. **MBCEF** shall enter into an agreement with **TCT** whereby **TCT** shall provide services for behavioral health and **TCT** shall provide certain schedules and reports as follows:
 - a) A monthly report of services provided at each of the **Participating Schools** shall be provided to the **Participating Schools** and to **MBCEF**; and
 - b) A monthly and an annual report shall be provided to the **Participating Municipalities** and to **MBCEF** documenting the percent of students returning to class after all visits relative to the above services at the **Participating Schools**.
2. On or before November 10, 2018, **MBCEF** shall provide funding to **TCT** for the 2018/2019 Nurse Enhancement Initiative in the amount of \$7,000.
3. On or before October 31, 2018, the **Participating Municipalities** shall provide their proportionate share of funds for the 2018/2019 Nurse Enhancement Initiative to **MBCEF**, subject to budget approval by the **Participating Municipalities**, which funds **MBCEF** shall hold in escrow pending the execution of its agreement with **TCT** referenced in paragraph 1. The **Participating Municipalities'** proportionate remaining share of funding for the 2018/2019 School Year shall be paid by October 31, 2018 in the following amounts:
 - i) **CMB** shall provide funding in the amount of \$15,400.00;
 - ii) **NBV** shall provide funding in the amount of \$6,600.00;
 - iii) **TBHI** shall provide funding in the amount of \$3,667.00;
 - iv) **TS** shall provide funding in the amount of \$3,667.00;
 - v) **BHV** shall provide funding in the amount of \$3,667.00;
4. **MBCEF** shall serve as the fiscal agent to collect the funds to be paid as provided in paragraph 3 above and shall disperse such funds to **TCT** after

entering into the agreement with **TCT** referenced in paragraph 1 and upon receipt of invoices from **TCT**.

5. **MBCEF** shall indemnify and hold harmless the **Participating Municipalities** and their respective officers employees, agents and instrumentalities from any and all liability, losses, or damages, including attorneys' fees and costs of defense, which the **Participating Municipalities** or their officers, employees agents or instrumentalities may incur as a result of claims, demands, suits, causes of actions or proceedings of any kind or nature arising out of, relating to, or resulting from the performance of this **MOU** by **MBCEF** or its employees, agents, servants, partners, principals, or subcontractors. **MBCEF** shall pay claims and losses in connection therewith and shall investigate and defend all claims suits or actions of any kind or nature in the name of the **Participating Municipalities**, where applicable, including appellate proceedings, and shall pay all costs, judgements, and attorney's fees which may issue thereon.
6. In the event that one or more of the **Participating Municipalities** is not able to secure funds for their respective proportionate share of funding as provided in paragraph 3, then the remaining contributing **Participating Municipalities** may, in coordination with the **MBCEF** agree in writing to adjust the services to be provided through the Nurse Enhancement Initiative.
7. In the event that any of the provisions in this **MOU** are not performed, or if the 2018/2019 Nurse Enhancement Initiative is terminated after funds have been dispersed to **MBCEF** as provided in paragraphs 3 and 4, then **MBCEF** shall promptly reimburse each of the **Participating Municipalities** their proportionate share of unused funds. If any combination or all of the **Participating Municipalities** agree to implement a Nurse Enhancement Initiative for the 2019/2020 School Year, then **MBCEF** may, as directed by the Participating Municipalities in writing, hold any unused funds in escrow to be applied toward the 2019/2020 Nurse Enhancement Initiative. Any unused funds shall be credited toward each of the **Participating Municipalities'** proportionate share for the 2019/2020 Nurse Enhancement Initiative.

IN WITNESS THEREOF, the Parties hereto have executed by their respective and duly authorized officers the day and year first above written.

ATTEST:

CITY OF MIAMI BEACH, a Municipal Corporation of the State of Florida

By: 
Rafael E. Granado, City Clerk

By: 
Dan Gelber, Mayor

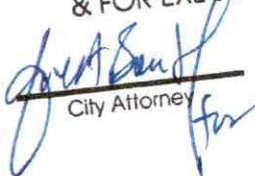

APPROVED AS TO
FORM & LANGUAGE
& FOR EXECUTION

City Attorney

4/2/18
Date

ATTEST:

NORTH BAY VILLAGE, a Municipal Corporation of the State of Florida

By: 
Village Clerk

By:  - school nurse
Village Manager

Approved as to form and
Legal sufficiency

NORMAN C. Powell

ATTEST:

TOWN OF BAY HARBOR ISLANDS, a Municipal Corporation of the State of Florida

By: 
Town Clerk

By: 
Mayor/Town Manager

Approved as to form and
Legal sufficiency

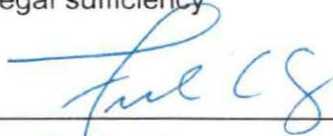
Frank Simons, Esq.
Asst. Town Atty.

ATTEST:

By: 
Town Clerk

TOWN OF SURFSIDE, a Municipal Corporation of the State of Florida

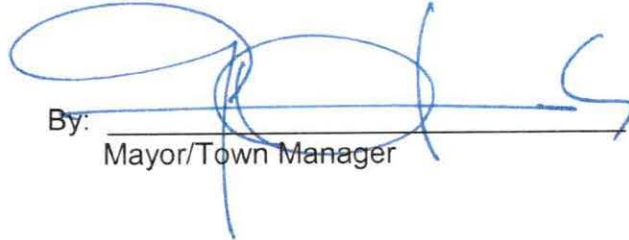
By: 
Mayor/Town Manager

Approved as to form and
Legal sufficiency

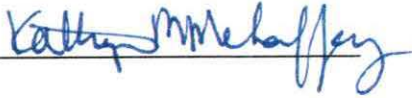

ATTEST:

BAL HARBOUR VILLAGE, a Municipal Corporation of the State of Florida

By: 
Village Clerk

By: 
Mayor/Village Manager

Approved as to form and
Legal sufficiency



ATTEST:

**MIAMI BEACH CHAMBER EDUCATION
FOUNDATION**

By: Jenny Hernandez

By: Jerry Hillman, President of C&E

Approved as to form and
Legal sufficiency



MEMORANDUM

ITEM NO. 5C

To: Honorable Mayor, Vice-Mayor and Members of the Town Commission
From: Commissioner Nelly Velasquez
Date: July 14, 2020
Subject: Undergrounding Power Lines

The Town of Surfside is considering whether to pay to move overhead power lines underground.

Undergrounding power lines can have a number of resiliency and sustainability benefits, including aesthetics, reliability and safety.

Aesthetics-wise, undergrounding removes overhead power lines and poles that may be considered unsightly. (However, pad-mounted power equipment (e.g. transformer boxes) will still be visible aboveground.) Undergrounding also reduces the need for property owners and FPL to trim trees.

In terms of safety, undergrounding reduces the number of power lines and poles that may potentially be brought down by high winds or lightning, especially during tropical storms or hurricanes. Contact between live wires and water can have dangerous and even deadly consequences. In 2004 in Queens, a young couple was tragically electrocuted after exiting their car into flood waters near where a power line had fallen. Additionally, following Superstorm Sandy, more than 100 homes in the Breezy Point neighborhood were destroyed by a massive fire that resulted from contact between power lines and sea water. Undergrounding may impact this type of risk. Additionally, it reduces the number of poles above ground that drivers may collide with in a vehicle accident.

With regard to reliability, a presentation from the Village of Key Biscayne (which is currently working on undergrounding its lines) estimates that undergrounding can provide up to an 80 percent reduction in the average number of interruptions per year, and an 80 percent reduction in outage duration per year. The presentation does note a downside: because lines are out of sight, it may take longer to identify and resolve the cause of outage. Additionally, pad-mounted equipment (e.g. transformers) may take longer to restore during a flood event.

The estimated cost in Surfside is approximately \$16,000,000; however, that number may have changed in the time since the cost analysis took place.

There are two main options for how the Town could cover the costs associated with this project:

The preferred option is to obtain a grant from FEMA, Florida Power & Light (FPL) or another source or sources. Ideally, one or more grants would cover some of the costs of this project.

Any costs not covered by grants could be covered if the Town obtained a GO bond (general obligation bond). A GO bond could be payable either in 20 or 30 years with annual excess money that would otherwise go into the Town's reserves. In this case, there would be no need to raise the millage rate. Only if the Town wanted to pay the bond in less than 20 years would the millage rate be raised (to no more than 4.8). This change would provide an additional amount of \$1,180,000 per year to pay off the bond sooner.



May 31, 2018

Mr. Guillermo Olmedillo
Town Manager
Town of Surfside
9293 Harding Ave.
Surfside, FL 33154

**Re: Town of Surfside
Electric Facilities Conversion – Ballpark Estimate
Entire Town
WR # 8245255**

Dear Mr. Olmedillo:

FPL welcomes the opportunity to assist you in examining the feasibility of converting from overhead electric distribution facilities to an underground system at the following location:

Entire Town limits in Surfside, Florida.

As per your request, the non-binding "ballpark" estimate to complete this conversion is \$6,700,000. This estimate is provided strictly to assist you in preliminary decision making and it does not include the conversion of any existing streetlight system. It is not an offer from FPL to perform the requested conversion and should not be construed or used as such for detailed planning purposes. This represents an "order of magnitude" figure based on previous FPL experience and reflects the CIAC payment that the Town would ultimately need to make to FPL if the conversion were performed at this point in time utilizing standard underground equipment. It is our experience that conversions in developed areas are the most complex and challenging types of construction. As such, this estimate likely will not precisely represent the Town's ultimate actual cost to convert, but can assist the Town in preliminary decision-making.

FPL estimates include only estimated charges to be paid by the Town to FPL. The costs of the following items are not included with the estimate and are the responsibility of the Town / residents. These potential costs should be included in future planning of the project:

- Site restoration (sod, landscaping, pavement, sidewalks, etc)
- Rearrangement of customer electric service entrances (requires electrician) from overhead to underground. Also, additional customer expense if local inspecting authorities require customer wiring to be brought to current codes.
- Trenching/backfilling for service laterals.
- Removal and undergrounding of other utilities (e.g. telecom, CATV, etc.)
- Acquiring, describing, securing and recording of easements for underground facilities. In underground systems, major components formerly attached to poles must now occupy "at grade" appurtenances, e.g., ground level pad mounted transformers and switch cabinets. Facilities of an underground distribution system will not be placed in road right-of-way, with the exception of cables required for crossings. (See special note below)

Note: Obtaining easements is typically the most difficult aspect of the conversion process; the time required to secure the easements may even exceed the 180 day binding estimate timeframe. FPL strongly suggests that all easements required for the conversion be described and secured prior to requesting the detailed cost estimate.

In 2007, the Public Service Commission approved FPL's 25% Governmental Adjustment Factor (G.A.F.) waiver for local government sponsored projects. In order to be eligible for the G.A.F. waiver a project must meet a series of criteria (see Attachment). Based on the preliminary information you provided for the proposed conversion area, this request would qualify for the G.A.F. waiver. The G.A.F. waiver amount is not reflected in the ballpark estimate presented above.

After reviewing the "ballpark" estimate, if you decide to move forward with the conversion project, you may request a detailed and "binding" estimate. Due to the complexity and time required to estimate such a conversion, a non-refundable engineering deposit is required prior to beginning the estimating process, as set forth in the Florida Administrative Code 25-6.115. For this conversion project the amount of the required engineering deposit is \$60,432.00. If you decide to proceed with the work contained in the estimate, the amount of this deposit would be applied toward the estimated amount owed to FPL for the conversion. The work must commence within 180 days of the date the binding estimate is provided.

The request for the binding estimate must be in writing, and must describe in detail the facilities to be converted. Binding estimates are valid for 180 days, and would be subject to change in the event of a work scope change. Should actual FPL costs exceed the binding estimate amount, the customer may be responsible for those additional costs up to a maximum of 10% of the binding estimate amount. Payment of customer costs, easements (with opinion of title and recorded), agreements from other utilities/pole licensees, and execution of a Conversion Agreement would be required before commencement of construction.

If you have any questions or wish to consider a binding cost estimate, please call me at 305-442-5711.

Sincerely,

Jose Triana
Customer Advisor
Customer Service
Florida Power & Light Company

Attachments

cc: Mr. Tom Allain – FPL
Mr. John Lehr – FPL
Mr. Roger Mendoza – FPL

FPL Undergrounding

Guillermo Olmedillo <golmedillo@townofsurfsidefl.gov>

Mon 4/8/2019 5:01 PM

To: **Elected Officials** <ElectedOfficials@townofsurfsidefl.gov>

Mayor, Vice Mayor and Commissioners:

In order to keep you informed, the message below explains the latest position by FPL in reference to undergrounding utilities.

Should you have questions, please advise.

Thank you



Guillermo Olmedillo

Town Manager

Town of Surfside

9293 Harding Ave

Surfside, FL 33154

(305) 861-4863 (305) 993-5097 F

Email: golmedillo@townofsurfsidefl.gov

www.townofsurfsidefl.gov

P Please consider the environment before printing this e-mail



TREE CITY USA

Guillermo,

I spoke to John Lehr and Aletha Player of FPL on Friday afternoon, and I think I have some information of substance to share with you.

Easements/ROW agreement

With respect to the need for easements beyond the existing R-O-W: easements beyond the R-O-W limits are NOT REQUIRED as a matter of policy. In lieu of that, FPL is willing to accept a R-O-W agreement with the TOWN to memorialize an agreement between the two parties that should the Town or any other agency require FPL to relocate, adjust, or rearrange any of their underground facilities, the Town (or other agency) will provide FPL with an alternative location for the facilities and will pay any costs associated with the relocation, adjustment, or rearrangement, AND the Town (or other Agency) shall also reimburse FPL for any

costs to locate, expose, or protect, or support their facilities, in the event of future construction or excavation in close proximity to the FPL facilities.

The need for easements beyond the R-O-W limits may be dictated by the availability of space for FPL's (and cable TV and telephone) within the ROW vis-à-vis other underground utilities, and the physical space available for FPL's transformers and switch cabinets.

Easement sizes

FPL's standard easement sizes are: 10' x 10' for their residential transformers (4'-0" x 4'-6" pad) and 24' x 24' for their switch cabinets (largest pad = 84" x 84", Vista u/g vault = 79" x 72"). The transformer easements are probably the minimum size they can be. However, John and Aletha have indicated that they will work with us to minimize easement sizes as merited. So, the smallest easement we may be able to provide for the Vista cabinets is 13' x 18'.

Moving Forward

If the Town is interested in moving forward with FPL, and if you are interested in pursuing the avenue that avoids the need for easements beyond the R-O-W's from each homeowner, then we need to provide to FPL:

1. The Engineering Deposit of \$60,432, as previously outlined in our white paper, and
2. As-built records of the existing underground utilities.

It's worth noting that FPL previously completed their design of this system in 2012 or 2013. I believe CGA provided them with as-builts of the underground utilities existing at that time. So, we should be able to locate their drawings and the utility as-builts from that project. We will have to re-obtain current utility as-builts, in case anything has changed, including the infrastructure work we completed with the Town at that time.

John Lehr recalls that FPL's previous design located as many of the transformers and switch cabinets as possible on Town property, thereby simplifying any easement acquisition efforts. We expect they will replicate this consideration in their updated design.

Please call me if you wish to discuss further.

Thank you,

Curt Keyser, P.E.

Director of Engineering | Engineering (Broward)



Calvin, Giordano & Associates, Inc. | [1800 Eller Drive](#) | [Suite 600](#) | [Fort Lauderdale, FL 33316](#)

Office: 954.921.7781 | Direct: 954.766.2752 | Fax: 954.921.8807

Fort Lauderdale | Miami-Dade | West Palm Beach | Clearwater/Tampa | Estero | Port St. Lucie

Official Internet Site of the Florida Legislature

September 17, 2019

Search Statutes: 2019

[Text: 'NEW Advanced Legislative Search'](#)

Select Year: 2019

[Home](#)

[Senate](#)

[House](#)

[Citorator](#)

[Statutes, Constitution, & Laws of Florida](#)

- [Florida Statutes](#)
- [Search Statutes](#)
- [Search Tips](#)
- [Florida Constitution](#)
- [Laws of Florida](#)

[Legislative & Executive Branch Lobbyists](#)

[Information Center](#)

[Joint Legislative Committees & Other Entities](#)

[Historical Committees](#)

[Florida Government Efficiency Task Force](#)

[Legislative Employment](#)

[Legistore](#)

[Links](#)

[Interpreter Services for the Deaf and Hard of Hearing](#)

The 2019 Florida Statutes

[Title XXVII](#)

RAILROADS AND OTHER REGULATED UTILITIES

[Chapter 366](#)

PUBLIC UTILITIES

[View Entire Chapter](#)

366.96 Storm protection plan cost recovery.—

(1) The Legislature finds that:

(a) During extreme weather conditions, high winds can cause vegetation and debris to blow into and damage electrical transmission and distribution facilities, resulting in power outages.

(b) A majority of the power outages that occur during extreme weather conditions in the state are caused by vegetation blown by the wind.

(c) It is in the state's interest to strengthen electric utility infrastructure to withstand extreme weather conditions by promoting the overhead hardening of electrical transmission and distribution facilities, the undergrounding of certain electrical distribution lines, and vegetation management.

(d) Protecting and strengthening transmission and distribution electric utility infrastructure from extreme weather conditions can effectively reduce restoration costs and outage times to customers and improve overall service reliability for customers.

(e) It is in the state's interest for each utility to mitigate restoration costs and outage times to utility customers when developing transmission and distribution storm protection plans.

(f) All customers benefit from the reduced costs of storm restoration.

(2) As used in this section, the term:

(a) "Public utility" or "utility" has the same meaning as set forth in s. [366.02](#)(1), except that it does not include a gas utility.

(b) "Transmission and distribution storm protection plan" or "plan" means a plan for the overhead hardening and increased resilience of electric transmission and distribution facilities, undergrounding of electric distribution facilities, and vegetation management.

(c) "Transmission and distribution storm protection plan costs" means the reasonable and prudent costs to implement an approved transmission and distribution storm protection plan.

(d) "Vegetation management" means the actions a public utility takes to prevent or curtail vegetation from interfering with public utility infrastructure. The term includes, but is not limited to, the mowing of vegetation, application of herbicides, tree trimming, and removal of trees or brush near and around electric transmission and distribution facilities.

(3) Each public utility shall file, pursuant to commission rule, a transmission and distribution storm protection plan that covers the immediate 10-year planning period. Each plan must explain the systematic approach the utility will follow to achieve the objectives of reducing restoration costs and outage times associated with extreme weather events and enhancing reliability. The commission shall adopt rules to specify the elements that must be included in a utility's filing for review of transmission and distribution storm protection plans.

(4) In its review of each transmission and distribution storm protection plan filed pursuant to this section, the commission shall consider:

(a) The extent to which the plan is expected to reduce restoration costs and outage times associated with extreme weather events and enhance reliability, including whether the plan prioritizes areas of lower reliability performance.

(b) The extent to which storm protection of transmission and distribution infrastructure is feasible, reasonable, or practical in certain areas of the utility's service territory, including, but not limited to, flood zones and rural areas.

- (c) The estimated costs and benefits to the utility and its customers of making the improvements proposed in the plan.
- (d) The estimated annual rate impact resulting from implementation of the plan during the first 3 years addressed in the plan.
- (5) No later than 180 days after a utility files a transmission and distribution storm protection plan that contains all of the elements required by commission rule, the commission shall determine whether it is in the public interest to approve, approve with modification, or deny the plan.
- (6) At least every 3 years after approval of a utility's transmission and distribution storm protection plan, the utility must file for commission review an updated transmission and distribution storm protection plan that addresses each element specified by commission rule. The commission shall approve, modify, or deny each updated plan pursuant to the criteria used to review the initial plan.
- (7) After a utility's transmission and distribution storm protection plan has been approved, proceeding with actions to implement the plan shall not constitute or be evidence of imprudence. The commission shall conduct an annual proceeding to determine the utility's prudently incurred transmission and distribution storm protection plan costs and allow the utility to recover such costs through a charge separate and apart from its base rates, to be referred to as the storm protection plan cost recovery clause. If the commission determines that costs were prudently incurred, those costs will not be subject to disallowance or further prudence review except for fraud, perjury, or intentional withholding of key information by the public utility.
- (8) The annual transmission and distribution storm protection plan costs may not include costs recovered through the public utility's base rates and must be allocated to customer classes pursuant to the rate design most recently approved by the commission.
- (9) If a capital expenditure is recoverable as a transmission and distribution storm protection plan cost, the public utility may recover the annual depreciation on the cost, calculated at the public utility's current approved depreciation rates, and a return on the undepreciated balance of the costs calculated at the public utility's weighted average cost of capital using the last approved return on equity.
- (10) Beginning December 1 of the year after the first full year of implementation of a transmission and distribution storm protection plan and annually thereafter, the commission shall submit to the Governor, the President of the Senate, and the Speaker of the House of Representatives a report on the status of utilities' storm protection activities. The report shall include, but is not limited to, identification of all storm protection activities completed or planned for completion, the actual costs and rate impacts associated with completed activities as compared to the estimated costs and rate impacts for those activities, and the estimated costs and rate impacts associated with activities planned for completion.
- (11) The commission shall adopt rules to implement and administer this section and shall propose a rule for adoption as soon as practicable after the effective date of this act, but not later than October 31, 2019.

History.—s. 1, ch. 2019-158.

Copyright © 1995-2019 The Florida Legislature • [Privacy Statement](#) • [Contact Us](#)

RESOLUTION NO. 2020

A RESOLUTION OF THE TOWN COMMISSION OF THE TOWN OF SURFSIDE, FLORIDA, CALLING FOR A TOWN OF SURFSIDE SPECIAL ELECTION TO BE HELD ON NOVEMBER 3, 2020 FOR THE PURPOSE OF SUBMITTING TO THE ELECTORATE A BALLOT QUESTION AS A NON-BINDING REFERENDUM CONCERNING UNDERGROUNDING OF UTILITIES; PROVIDING FOR NOTICE OF ELECTION; PROVIDING REQUISITE BALLOT LANGUAGE FOR SUBMISSION TO THE ELECTORATE; PROVIDING FOR THE TOWN CLERK TO UTILIZE THE SERVICES OF MIAMI-DADE COUNTY SUPERVISOR OF ELECTIONS FOR THE SPECIAL ELECTION; AND PROVIDING FOR AN EFFECTIVE DATE.

WHEREAS, as a coastal community susceptible to wind and storm events, the Town of Surfside (“Town”) Commission recognizes the importance of undergrounding utilities and the positive aesthetic impacts of such undergrounding; and

WHEREAS, the Town Commission wishes to seek the non-binding approval of the electors by a ballot question referendum concerning the undergrounding of electric and other public utilities and the expenditure of funds for such purposes; and

WHEREAS, in accordance with provisions of the Charter of the Town of Surfside (“Town”) and the general laws of the State of Florida, a Special Election is hereby called and directed to be held in the Town of Surfside, Florida, from 7:00 a.m. to 7:00 p.m. on Tuesday, November 3, 2020, for the purpose of submitting to the electorate the proposed referendum ballot language concerning undergrounding of utilities which is set forth herein; and

WHEREAS, not less than thirty (30) days’ notice of the adoption of this Resolution and of its provisions calling this Special Election shall be given by publication in the Miami Herald, a newspaper of general circulation in Surfside, Miami-Dade County, Florida. Such publication shall be made once in the fifth week before the election and once in the third week before the election in accordance with the provisions of Section 100.342, Florida Statutes, and the Town Code.

NOW THEREFORE, BE IT RESOLVED BY THE TOWN COMMISSION OF THE TOWN OF SURFSIDE, FLORIDA, AS FOLLOWS:

Section 1. Recitals Adopted. The above recitals are true and correct and incorporated into this Resolution by this reference.

Section 2. Special Election Called; Notice of Election. That a special election is hereby called, to be held on Tuesday, November 3, 2020, in conjunction with a County-wide election, to present to the qualified electors of the Town of Surfside, the ballot question provided in this Resolution. Notice of said election shall be published in accordance with Section 100.342, Florida Statutes, in the Miami Herald, a newspaper of general circulation in Surfside, Miami-Dade County, Florida. at least thirty (30) days prior to said election, the first publication to be in the fifth week prior to the election (to-wit: during the week commencing Sunday, September 27, 2020), and the second publication to be in the third week prior to the election (to-wit: during the week commencing Sunday, October 11, 2020), and shall be in substantially the following form:

“THE TOWN OF SURFSIDE, FLORIDA

NOTICE OF REFERENDUM SPECIAL ELECTION

PUBLIC NOTICE IS HEREBY GIVEN THAT PURSUANT TO RESOLUTION NO. _____ ADOPTED BY THE TOWN COMMISSION OF THE TOWN OF SURFSIDE, FLORIDA (“TOWN”), A SPECIAL ELECTION HAS BEEN CALLED AND ORDERED TO BE HELD WITHIN THE TOWN ON TUESDAY, NOVEMBER 3, 2020, BETWEEN THE HOURS OF 7:00 A.M. AND 7:00 P.M., AT WHICH TIME THE FOLLOWING BALLOT QUESTION REFERENDUM SHALL BE SUBMITTED TO THE QUALIFIED ELECTORS OF THE TOWN:

NON-BINDING REFERENDUM CONCERNING UNDERGROUNDING OF UTILITIES

Do you favor the undergrounding of Surfside’s powerlines and other utilities, including cable and telephone lines, in order to improve safety, promote sustainability and resilience in the case of hurricanes and enhance the aesthetic character of the Town?

YES []

NO []

The polling place for the Special Election shall be the Surfside Town Hall located at 9293 Harding Avenue, Surfside, Florida 33154 and any other polling places provided for the Town election. All Town electors who are timely registered shall be eligible to vote. The enabling Resolution, including the ballot question are available at the Office of the Town Clerk, located at the Surfside Town Hall.

Sandra McCready, MMC, Town Clerk”

Section 3. **Form of Ballot.** The form of ballot for the referendum special election provided for in Section 2 of this Resolution shall be substantially as follows:

“NON-BINDING REFERENDUM CONCERNING UNDERGROUNDING OF UTILITIES

Do you favor the undergrounding of Surfside’s powerlines and other utilities, including cable and telephone lines, in order to improve safety, promote sustainability and resilience in the case of hurricanes and enhance the aesthetic character of the Town?

YES []

NO [] “

The form of the ballot to be used in this Special Election and its preparation shall be in compliance with all statutory requirements relating to the use of mechanical or other approved voting machines or devices.

Section 4. **Balloting.** That balloting shall be conducted between the hours of 7:00 a.m. until 7:00 p.m. on election day at the regular polling places for Town elections. Vote-by-mail ballots and early voting shall be provided as authorized by law. All qualified Town electors who are timely registered in accordance with law shall be entitled to vote.

Section 5. **Available for Public Inspection; Town Clerk to Utilize the Services of Miami-Dade County Supervisor of Elections.** Copies of this Resolution providing for the special election referendum are on file in the Office of the Town Clerk located at 9293 Harding Avenue, Surfside, Florida and are available for public inspection during regular business hours.

Furthermore, the Town Clerk is authorized to utilize the services of Miami-Dade County Supervisor of Elections for any assistance required in the administration of the election. The Town shall pay all expenses for conducting this Special Election and will pay such expenses to Miami-Dade County upon receipt of invoice or statement approved by the Supervisor of Elections of Miami-Dade County, Florida.

Section 6. Authorization of Town Officials. The Town Manager, Town Attorney and Town Clerk are hereby authorized to take all steps necessary to complete the execution and implementation of the terms and purposes of this Resolution, and the non-binding Special Election Referendum if adopted and effective.

Section 7. Effective Date. This Resolution shall be effective immediately upon its adoption.

PASSED AND ADOPTED this ____ day of July, 2020.

Moved By: _____
Second By: _____

FINAL VOTE ON ADOPTION

Commissioner Charles Kesl _____
Commissioner Eliana R. Salzhauer _____
Commissioner Nelly Velasquez _____
Vice Mayor Tina Paul _____
Mayor Charles W. Burkett _____

Charles W. Burkett, Mayor

ATTEST:

Sandra McCready, MMC, Town Clerk

**APPROVED AS TO FORM AND LEGAL SUFFICIENCY
FOR THE TOWN OF SURFSIDE ONLY:**

Town Attorney



MEMORANDUM

ITEM NO. **5D**

To: Honorable Mayor, Vice-Mayor and Members of the Town Commission

From: Jason Greene, Interim Town Manager

Date: July 14, 2020

Subject: Solid Waste Services Special Assessment Preliminary Rate Resolution

The Town annually special assesses residential properties of 4 units or less per parcel for the cost of solid waste services those properties will receive during the fiscal year. This assessment process uses the property tax bill as the billing and collection method for the revenue needed to help pay for the services the residents receive.

The Town could elect to bill and collect for these services instead of using the property tax method, but the cost would be more to do so and the collection of money would likely not be as great. Residents are accustomed to this process.

The billing will collect about \$350,000 or \$318.67 per dwelling unit from this process which will be used to pay for the cost of solid waste services. The Town bills other properties, including residential parcels that have more than 4 units, for commercial solid waste services. This billing is done by the Town's Finance Department.

This resolution will set the place, date, and time of the public hearing on the final assessment resolution. This notice will be placed on the property tax bill and a newspaper display ad will also be published. The final hearing is scheduled for September 10th. Once approved, the assessment roll will be given to the property appraiser and tax collector for billing and collection on the property tax bills that typically are mailed out in November. Property owners that fail to pay any part of their property tax bill, including this assessment, could lose title to their property.

We recommend that the Commission adopt the resolution as a matter precedent to the final assessment resolution. This resolution does not levy the assessment, but merely notices the public of the Town's intent to again assess for this service and sets the place, date, and time for the final hearing.

Reviewed by LA

Prepared by JG

TOWN OF SURFSIDE, FLORIDA

**PRELIMINARY RATE RESOLUTION
FOR SOLID WASTE MANAGEMENT SERVICES**

ADOPTED July 14, 2020

RESOLUTION NO. 2020-_____

A RESOLUTION OF THE TOWN OF SURFSIDE, FLORIDA, RELATING TO SOLID WASTE MANAGEMENT SERVICES, INCLUDING COLLECTION, DISPOSAL AND RECYCLING OF RESIDENTIAL SOLID WASTE IN THE TOWN OF SURFSIDE, FLORIDA; ESTABLISHING THE ESTIMATED ASSESSMENT RATE FOR SOLID WASTE SERVICE ASSESSMENTS AGAINST ASSESSED PROPERTY LOCATED WITHIN THE TOWN OF SURFSIDE, FLORIDA, FOR THE FISCAL YEAR BEGINNING OCTOBER 1, 2020; DIRECTING THE PREPARATION OF AN UPDATED ASSESSMENT ROLL; AUTHORIZING A PUBLIC HEARING AND DIRECTING THE PROVISION OF NOTICE THEREOF; AND PROVIDING AN EFFECTIVE DATE.

WHEREAS, the Town Commission (the "Commission") of the Town of Surfside, Florida (the "Town"), has enacted Ordinance No. 2018-1687 (the "Ordinance"), which authorizes the annual reimposition of annual Solid Waste Service Assessments for Solid Waste collection, disposal and recycling services for Residential Property and certain Assessed Property within the Town; and

WHEREAS, the imposition of a Solid Waste Service Assessment for Solid Waste collection, disposal and recycling services for each Fiscal Year is an equitable and efficient method of allocating and apportioning Solid Waste Costs among parcels of Assessed Property; and

WHEREAS, the Commission desires to reimpose an annual Solid Waste Service Assessment for collection, disposal and recycling services, through an assessment program within the Town, using the tax bill collection method for the Fiscal Year beginning on October 1, 2020.

NOW, THEREFORE, BE IT RESOLVED BY THE TOWN COMMISSION OF THE TOWN OF SURFSIDE, FLORIDA, AS FOLLOWS:

SECTION 1. AUTHORITY. This Resolution is adopted pursuant to the provisions of the Solid Waste Management Services Assessment Ordinance (Ordinance No. 2018-1687), the Initial Assessment Resolution (Resolution No. 2018-2524), the Final Assessment Resolution (Resolution No. 2018-2534), Sections 166.021 and 166.041, Florida Statutes, and other applicable provisions of law.

SECTION 2. PURPOSE AND DEFINITIONS. This resolution constitutes the Preliminary Rate Resolution as defined in the Ordinance which initiates the annual process for updating the Assessment Roll and directs the reimposition of Solid Waste Service Assessments for the Fiscal Year beginning October 1, 2020. All capitalized words and terms not otherwise defined herein shall have the meanings set forth in the Ordinance, the Initial Assessment Resolution and the Final Assessment Resolution. Unless the context indicates otherwise, words imparting the singular number, include the plural number, and vice versa.

SECTION 3. PROVISION AND FUNDING OF SOLID WASTE SERVICES.

(A) Upon the imposition of Solid Waste Service Assessments for Solid Waste collection, disposal and recycling services against Assessed Property located within the Town, the Town shall provide Solid Waste collection, disposal and recycling services to such Assessed Property.

(B) It is hereby ascertained, determined, and declared that each parcel of Assessed Property will be benefited by the Town's provision of Solid Waste

Management Services in an amount not less than the Solid Waste Service Assessment imposed against such parcel, computed in the manner set forth in this Preliminary Rate Resolution.

SECTION 4. LEGISLATIVE DETERMINATIONS OF SPECIAL BENEFIT AND FAIR APPORTIONMENT. The legislative determinations of special benefit and fair apportionment embodied in the Ordinance, the Initial Assessment Resolution and the Final Assessment Resolution are affirmed and incorporated herein by reference.

SECTION 5. ESTABLISHMENT OF ANNUAL SOLID WASTE SERVICE ASSESSMENT RATE.

(A) For the Fiscal Year beginning October 1, 2020, for which Solid Waste Service Assessments for Solid Waste collection, disposal and recycling services are to be reimposed, the Solid Waste Cost shall be allocated among all parcels of Assessed Property, based upon the methodology and procedures set forth in the Ordinance. The total Solid Waste Cost for the Fiscal Year beginning October 1, 2020 is estimated to be \$350,282. Accordingly, a rate of assessment equal to \$318.67 for each Dwelling Unit for solid waste management services, including collection, disposal and recycling services is hereby approved for the Fiscal Year beginning October 1, 2020.

(B) In accordance with Section 2.08 of the Ordinance, a maximum assessment rate of \$400.00 per Dwelling Unit for solid waste collection, disposal and recycling services was approved for the Fiscal Year beginning October 1, 2019, and future fiscal years.

(C) The Town Manager is hereby directed to prepare, or cause to be prepared, an updated Assessment Roll for the Fiscal Year beginning October 1, 2020 in the manner provided in the Ordinance. Such updated Assessment Roll shall contain the following: (1) a summary description of all Assessed Property within the Town conforming to the description contained on the Tax Roll, (2) the name and address of the Owner of record of each parcel as shown on the Tax Roll, and (3) the amount of the Solid Waste Service Assessment attributable to each Dwelling Unit for Solid Waste collection, disposal and recycling services.

(D) A copy of this Preliminary Rate Resolution, the Ordinance, the Initial Assessment Resolution, the Final Assessment Resolution and the updated Assessment Roll is maintained on file in the office of the Town Clerk and open to public inspection. The foregoing shall not be construed to require that the updated Assessment Roll be in printed form if the amount of the Solid Waste Service Assessment for each parcel of property can be determined by use of a computer database available to the public.

(E) The Solid Waste Service Assessment for each parcel of Assessed Property shall be computed by multiplying the assessment rate by the number of Dwelling Units on such parcel.

(F) It is hereby ascertained, determined, and declared that the foregoing method of determining the Solid Waste Service Assessments for Solid Waste collection, disposal and recycling services is a fair and reasonable method of apportioning the Solid Waste Cost therefore among parcels of Assessed Property.

SECTION 6. AUTHORIZATION OF PUBLIC HEARING. There is hereby established a public hearing to be held at 7:00 p.m. on September 15, 2020, at Town of Surfside Town Hall, Commission Chambers, 9293 Harding Avenue, Surfside, Florida 33154, for the purpose of (A) receiving and considering any comments on the Solid Waste Service Assessments from affected property owners and (B) authorizing the reimposition of such Solid Waste Service Assessments for Solid Waste collection, disposal and recycling services for the Fiscal Year beginning October 1, 2020 and collecting such assessments on the same bill as ad valorem taxes.

SECTION 7. NOTICE BY PUBLICATION. The Town Manager shall publish a notice, as required by Section 2.04 of the Ordinance, in substantially the form attached hereto as Appendix A. Such notice shall be published no later than August 26, 2020 in a newspaper generally circulated in Miami-Dade County.

SECTION 8. NOTICE BY MAIL. The Town Manager shall provide notice by first class mail to the Owner of each parcel of Assessed Property which has been reclassified or issued a new Certificate of Occupancy (C.O.) pursuant to a building permit for a Dwelling Unit that was not included on the Assessment Roll approved for the prior fiscal year, and in the event circumstances described in Section 2.08(F) of the Ordinance so require. Such notice shall be in substantially the form attached hereto as Appendix B. Such notices shall be mailed not later than August 26, 2020.

SECTION 9. EFFECTIVE DATE. This Preliminary Rate Resolution shall take effect immediately upon its passage and adoption.

PASSED, ADOPTED AND APPROVED THIS 14th day of July, 2020.

Motion By: _____
Second By: _____

FINAL VOTE ON ADOPTION

Commissioner Charles Kesl _____
Commissioner Eliana R. Salzhauer _____
Commissioner Nelly Velasquez _____
Vice Mayor Tina Paul _____
Mayor Charles W. Burkett _____

Attest:

Charles W. Burkett, Mayor

Sandra N. McCready, MMC
Town Clerk

Approved as to Form and Legal Sufficiency:

Weiss Serota Helfman Cole & Bierman, P.L.
Town Attorney

APPENDIX A

FORM OF NOTICE TO BE PUBLISHED

To Be Published by August 26, 2020

NOTICE OF HEARING TO REIMPOSE AND PROVIDE FOR COLLECTION OF SOLID WASTE SERVICE SPECIAL ASSESSMENTS

Notice is hereby given that the Town Commission of the Town of Surfside, Florida will conduct a public hearing to consider reimposing solid waste service assessments for the Fiscal Year beginning October 1, 2020, against certain improved residential properties located within the incorporated area of the Town, to fund the cost of solid waste collection, disposal and recycling services provided to such properties and to authorize collection of such assessments on the tax bill.

The public hearing will be held at 7:00 p.m. on September 15, 2020, at Town of Surfside Town Hall, Commission Chambers, 9293 Harding Avenue, Surfside, Florida 33154, for the purpose of receiving public comment on the proposed assessments. All affected property owners have a right to appear at the hearing and to file written objections with the Town Commission within 20 calendar days of the date of this notice. If a person decides to appeal any decision made by the Town Commission with respect to any matter considered at the hearing, such person will need a record of the proceedings and may need to ensure that a verbatim record is made, including the testimony and evidence upon which the appeal is to be made. In accordance with the Americans with Disabilities Act, persons needing a special accommodation or an interpreter to participate in this proceeding should contact the Town Clerk at (305) 861-4863, Ext. 226, at least 7 days prior to the date of the hearing.

The total annual solid waste assessment revenue to be collected within the Town of Surfside for the upcoming fiscal year is estimated to be \$350,282. The rate of assessment for the upcoming fiscal year shall be \$318.67 per Dwelling Unit. The maximum rate of assessment that can be imposed in the fiscal year commencing

October 1, 2019 and future fiscal years shall be \$400.00 per Dwelling Unit. Copies of the Solid Waste Management Services Assessment Ordinance (Ordinance No. 2018-1687), the Initial Assessment Resolution (Resolution No. 2018-2524), the Final Assessment Resolution (Resolution No. 2018-2534), the Preliminary Rate Resolution initiating the annual process of updating the Assessment Roll and reimposing the Solid Waste Service Assessments, and the updated Assessment Roll for the upcoming fiscal year are available for inspection at the Town Clerk's office, located at 9293 Harding Avenue, Surfside, Florida 33154.

If you have any questions, please contact the Town at (305) 861-4863, Ext. 226, Monday through Friday between 8:00 a.m. and 5:00 p.m.

The assessments will be collected on the ad valorem tax bill to be mailed in November 2020, as authorized by section 197.3632, Florida Statutes. Failure to pay the assessments will cause a tax certificate to be issued against the property which may result in a loss of title.

**TOWN COMMISSION OF
TOWN OF SURFSIDE, FLORIDA**

APPENDIX B

FORM OF NOTICE TO BE MAILED

*** * * * * NOTICE TO PROPERTY OWNER * * * * ***

**Town of Surfside
9293 Harding Avenue
Surfside, Florida 33154**

TOWN OF SURFSIDE, FLORIDA
NOTICE OF HEARING TO IMPOSE AND
PROVIDE FOR COLLECTION OF NON-AD
VALOREM ASSESSMENTS

NOTICE DATE: August 26, 2020

**Owner
Address
City, State Zip**

*Sequence #
Tax Parcel #
Legal Description:*

As required by section 197.3632, Florida Statutes, and the direction of the Town Commission, notice is given by Town of Surfside, Florida, that annual assessments for solid waste services using the tax bill collection method, may be reimposed and levied on your property. The use of an annual special assessment to fund solid waste services benefiting improved property located within the Town of Surfside, Florida, in the past has proven to be fair, efficient and effective. The total annual solid waste assessment revenue to be collected within the Town of Surfside, Florida is estimated to be \$350,282. The annual solid waste service assessment is based on the number of residential dwelling units contained on each parcel of property.

The following is a summary of the non-ad valorem special assessments being reimposed on the above parcel for the fiscal year beginning October 1, 2020.

The above parcel is subject to the solid waste service assessment:

The total number of residential dwelling units on the above parcel is _____.

The annual solid waste service assessment for the above parcel is \$318.67 for fiscal year commencing October 1, 2020.

The maximum annual solid waste service assessment for the above parcel is \$400.00 for the Town's fiscal year commencing October 1, 2019, and each fiscal year thereafter.

A public hearing will be held at 7:00 p.m. on September 15, 2020, Town of Surfside, Town Hall, Commission Chambers, 9293 Harding Avenue, Surfside, Florida 33154, for the purpose of receiving public comment on the proposed assessments. All owners of improved property within the Town were mailed individual notices similar to this one when the assessments were first imposed. Subsequently, only owners of reclassified property which resulted in an increased assessment, or owners of property not included on the prior year's assessment roll will receive updated mailed notice in addition to the annual published notice. You and all other affected property owners have a right to appear at the hearing and to file written objections with the Town Commission within 20 calendar days of the date of this notice. If you decide to appeal any decision made by the Town Commission with respect to any matter considered at the hearing, you will need a record of the proceedings and may need to ensure that a verbatim record is made, including the testimony and evidence upon which the appeal is to be made. In accordance with the Americans with Disabilities Act, persons needing a special accommodation or an interpreter to participate in this proceeding should contact the Town Clerk at (305) 861-4863, Ext. 226, at least seven (7) days prior to the date of the hearing.

Unless proper steps are initiated in a court of competent jurisdiction to secure relief within 20 days from the date of Town Commission action at the above hearing (including the method of apportionment, the rate of assessment and the imposition of assessments), such action shall be the final adjudication of the issues presented.

Copies of the legal documentation for the assessment program are available for inspection at the Town Clerk's office, located at 9293 Harding Avenue, Surfside, Florida 33154.

The special assessment amount shown on this notice and the ad valorem taxes for the above parcel will be collected on the ad valorem tax bill mailed in November of each year that the assessment is imposed. Failure to pay the assessment will cause a tax certificate to be issued against the property which may result in a loss of title.

If there is a mistake on this notice, it will be corrected. If you have any questions, please contact the Town Finance Department at (305) 861-4863, Monday through Friday between 8:00 a.m. and 5:00 p.m.



MEMORANDUM

ITEM NO. 9B

To: Honorable Mayor, Vice-Mayor and Members of the Town Commission
From: Jason Greene, Interim Town Manager
Date: July 14, 2020
Subject: Replacement Bins for Trash and Recycling Receptacles Throughout Town

Currently, the Town of Surfside has Big Belly compactor trash and recycling receptacles throughout Town for litter control. On June 23, 2020, the Town Commission de-appropriated the funding for the service and the vendor was summarily notified that the bins should be removed on October 1, 2020.

The Town will now save \$186,632 on the remaining 4 (four) year contract term costs. This savings will be partially offset by a one-time cost of between \$38,336 and \$59,666 replacement manual trash and recycling receptacles. This would mean between \$148,296 and \$126,966 costs savings to the Town over the next 4 (four) fiscal years based on the type of replacement trash and recycling receptacle chosen.

With the removal of the Big Belly trash compactor trash and recycling receptacles, new containers will be required in order to maintain continuity with litter control in Downtown Surfside and other areas within the Town where trash and recycling bins are currently deployed. The current Big Belly fleet is 29 dual stations which each station having a trash and recycling receptacle. A total of 30 dual stations to replace existing trash and recycling containers (for a total of 60 containers) will need to be procured.

Town Administration requested quotes from various vendors along with specification sheets. A breakdown of quotes and specifications can be found in **Table A – “Trash and Recycling Bin Options” below**:

Item number	Description	Total Quantity	Total Cost	Lead Time	Attachment Sheet
1	Stadium Series	60	\$41,055.90	6-8 Weeks	"A"
2	Personalized Trash / Recycling Bins	30	\$38,336.36	10 Weeks	"B"
3	Oakley Collection	60	\$50,126.07	4 Weeks	"C"
4	Claremont Double Stations	30	\$59,262.03	4-6 Weeks	"D"
5	Manchester Sideload Double Station	30	\$59,665.75	4-6 Weeks	"E"
6	Vancouver Combo Station	30	\$49,532.00	4-6 Weeks	"F"

Table A – “Trash and Recycling Bin Options” below”

Table A – “Trash and Recycling Bin Options” references an attachment sheet for each option. The attachment includes a specification sheet, provided quote and additional information. The information is being provided to the Town Commission in order to review and approve an option for procurement purposes. The new receptacles would need to be purchased in the Fiscal Year 2020 prior to the de-funding of the Big Belly program in order to maintain continuity of litter control. A budget amendment for the Solid Waste Fund will be presented at the next Commission meeting.

Reviewed by: JG/LA

Prepared by: HG/JG

Attachment "A"

Stadium Series Specifications

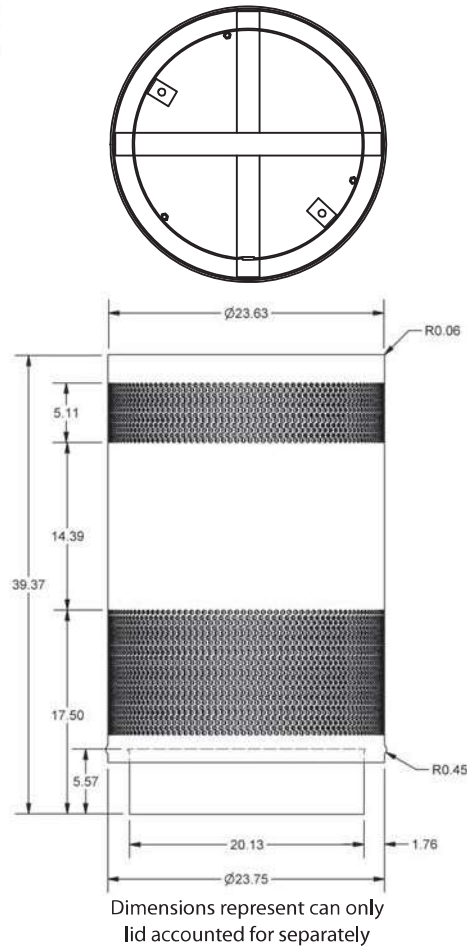

Product Features

- Custom logo capability to convey branding (see other models)
- 14 GA. Galvaneal metal
- Kick Plate Material: 12 GA. Galvaneal metal
- Bottom Cross Bar Supports: Cross Bars: (2) 7 GA. X 2" Steel bars in criss cross pattern to allow maximum drainage
- Flat Top Lid: .125 ABS Material with Textured Finish w/16" hole opening and 2" flanges
- Perforation Pattern: 3/8" Hole on 9/16" Stagger with 60 Degree Spacing
- Unit comes standard with 3 Stainless Steel Leveling Feet, Anchoring Feet, Anchor Kit and Lid Attachment Kit
- TGIC Polyester Powder Coat outdoor finish
- Custom colors available to match organizational branding

Options include:

- 3 Tops to choose from: Flat Top, Hood Top or Dome Top

Bottom Kick Plate Options:

- Plastic dipped base for durability and to protect your surfaces

BOTTOM VIEW

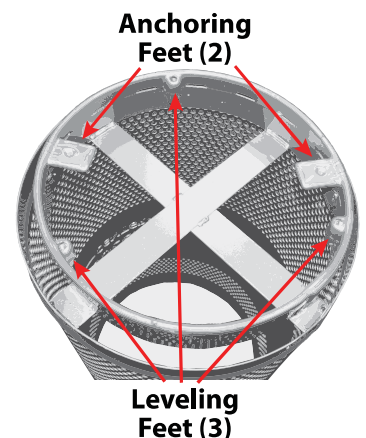

	Capacity	Dimensions	Weight
PAGE 314	55 gallons	23 1/2" dia x 40" high	86 lbs



Blue Streak



Post Office
Blue



Blue



Black



Charcoal



Bumper
Black



Taupe



Almond



Cream



White



Brown



Ultra
Orange



Yellow



Red



Red Baron



Deep Red



Scarlet
Red



Burgundy



Brass Gold



Green



Equipment
Green



Evergreen

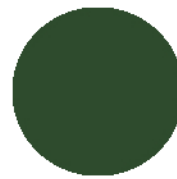

Moss Green

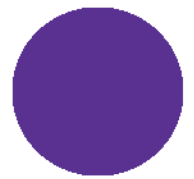

Purple



Silver Vein

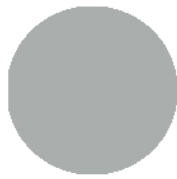

Stainless
Steel



Silver



Stone Gray



Slate

This color chart is for reference only and is not to be used for final color matching. Shades may vary due to the color and resolution of your computer screen and/or your color printer output.



Park Warehouse LLC
 7495 W. Atlantic Ave., Suite #200-294
 Delray Beach, FL 33446
 888-321-5334

**Quality Commercial Site Furnishings for
 Municipalities, Schools & Property Managers**

Billing

Hector Gomez
 Town of Surfside - Public Works
 9293 Harding Avenue
 Surfside, FL 33154
 Phone: 7867781728

Shipping

Hector Gomez
 Town of Surfside - Public Works
 9293 Harding Avenue
 Surfside, FL 33154

Quote: Q221756

Quote Date **Quote Expiration**
 June 5, 2020 30 Days (07/05/2020)

Sales Rep: Rosealee x521
Ref#:

\$41,055.90
 If you receive a lower quote, please remember our best price guarantee!

Description	SKU	Cost	Qty	Total
Stadium Series - Round - Trash Receptacle - w/ Plastic Liner & Flat Top Lid Capacity: 35 Gallons	450tr325-3	\$669.00 \$609.00	30	\$20,070.00 \$18,270.00
450 Series - Trash Receptacle Product 1 - Special Description : -Stadium Series -35 Gallon Recycle Logo Receptacle -Recycle Flat top Lid -Liner Color : Blue Streak With White Logo Recycle Flat top Lid: -Hole Option -TBD ** Free shipping ***: Free shipping on qty of 60 quoted	450-SPCL-TRASHRECEPTACLE-1	\$713.41 \$670.00	30	\$21,402.30 \$20,100.00

Discount	\$3,102.30
Subtotal	\$38,370.00
Shipping	\$0.00
Tax 7%	\$2,685.90
Total	\$41,055.90

Quote Note: All Trash can are made to -special order and therefore are non-cancellable and non-returnable. *** FREE SHIPPING ON QTY QUOTED OF 60*** Lead time to ship out is-6-8 weeks ** NO LIFT GATE SERVICE



Park Warehouse LLC

7495 W. Atlantic Ave., Suite #200-294

Delray Beach, FL 33446

888-321-5334

**Quality Commercial Site Furnishings for
Municipalities, Schools & Property Managers**



Park Warehouse LLC
 7495 W. Atlantic Ave., Suite #200-294
 Delray Beach, FL 33446
 888-321-5334

**Quality Commercial Site Furnishings for
 Municipalities, Schools & Property Managers**

SHIPPING:

All merchandise is sold F.O.B. Deliveries are made during normal business hours, 8am - 4pm Monday - Friday.
 • Standard shipping charges are for Tailgate delivery to any commercial location on a commercial truck route.
 • The truck driver is under no obligation to help you unload.
 • If you are unable to accept a shipment via this method you must purchase additional services.
 (Additional Services Available: Residential Delivery, Limited Access Delivery, Liftgate Service, Inside Delivery, Construction Site Delivery, Notify Before Delivery)

Customer Initials

SERVICE DISCREPANCIES:

If there is a discrepancy in the services requested and the minimum services required to deliver the product (either before or after delivery of product), Park Warehouse reserves the right to charge the customer for any necessary additional services provided at the time of delivery.

Customer Initials

INSPECTION OF SHIPMENTS (OR DAMAGED PRODUCT):

It is the customers responsibility to verify the delivery is for the correct product, count the number of pieces being delivered, and inspect for damages
 • All claims of damage MUST be recorded on the delivery receipt provided by the delivery driver at the time of delivery and reported to us within 48 hours of delivery.
 • Park Warehouse does NOT GUARANTEE replacement parts or product FREE of charge due to concealed or unreported damages

Customer Initials

CANCELLATIONS:

All cancellations must be done in writing prior to shipping. Made-to-Order items already in production may not be cancelled. Any order placed by credit card in excess of \$1000 and cancelled after the close of business on the day the order was placed shall incur a fee of 5%.

Customer Initials

RETURNS:

• We will accept returns of unused products up to 30 days from shipping date subject to ALL of the following terms and conditions:
 • Written approval: You must receive written approval and utilize the instructions issued by our Customer Service Department before any merchandise can be returned.
 • Shipping Returns: All merchandise must be returned in its original packaging, freight Prepaid. No Collect shipments are accepted.
 • Re-Stocking & Shipping Fees: The customer is responsible for a minimum 25% re-stocking fee and all related shipping charges on product returned for reasons other than damage or defect. Original shipping charges will not be refunded.

Customer Initials

* Web-Orders: For online orders, Park Warehouse is not responsible if customer orders incorrect product or colors. All return and restock fees apply.
 * Assembly Usually Required. Many of our products are shipped unassembled in order to minimize damage and lower freight charges.
 * **Made-to-Order or Personalized items are not returnable unless a defect in manufacturing is presented to us with pictures prior to return.**
 * **Unless Otherwise noted, shipping charges include standard delivery only. Liftgate service, notify before delivery available at additional cost.**

Force Majeure: No Party to this Agreement shall be responsible for any delays or failure to perform any obligation under this Agreement due to acts of God, outbreaks, epidemic/pandemic or the spreading of disease or contagion strikes or other disturbances, including, without limitation, war, insurrection, embargoes, governmental restrictions, acts of governments or governmental authorities, and any other cause beyond the control of such party. During an event of force majeure, the Parties' duty to perform obligations shall be suspended.

To accept this proposal, please sign below and initial each section above.

 Signature of Authorized Person

 Date

 Print Name

* **By signing you are placing a binding order and agree to the terms of the sale as stated herein.**

Quote#:

Q221756

Total:

\$41,055.90

Terms:

Credit Card

Attachment "B"

32 GAL. PERSONALIZED TRASH/RECYCLING BINS +/-liners, ashcan
SKU: 287tr180

Wt. 200 lbs

photo

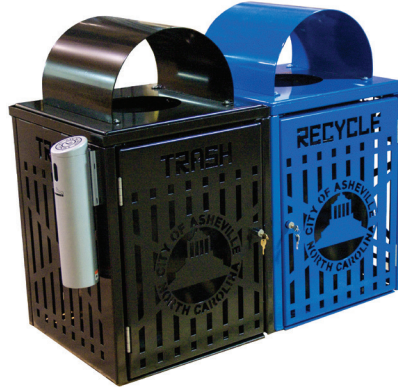

top view

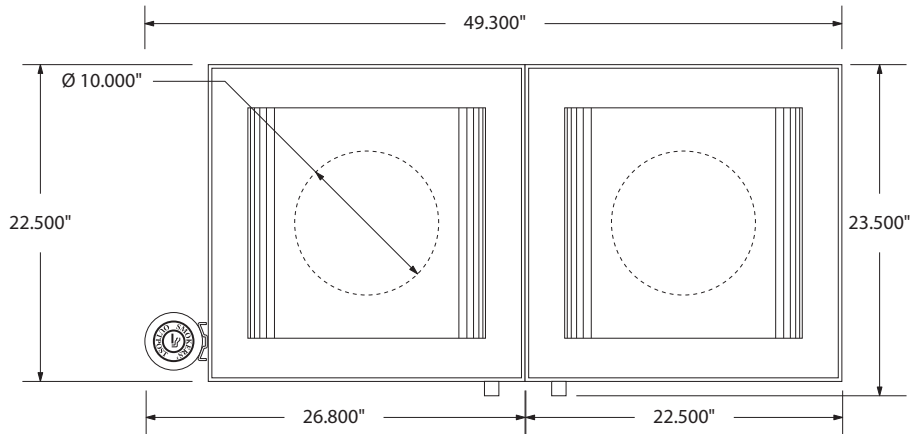

front view

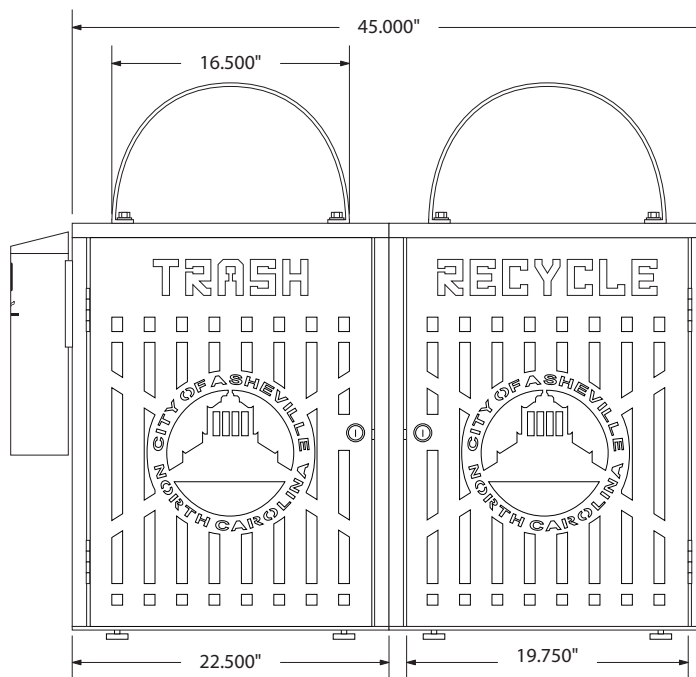

side view

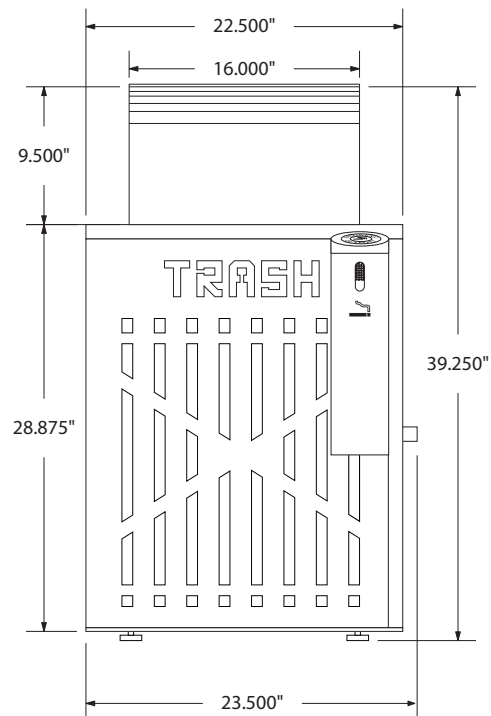

product details



Receptacles

- Dual dome lids are securely fastened
- 11 Gauge steel construction with diamond pattern in panel surfaces
- City of Asheville Seal is manufactured in each door
- Complete with secured cigarette ash/snuffer mounted on the side of the receptacles
- Eight [8] interior mounting holes for securing placement
- Eight [8] heavy-duty mounting levelers
- Dual front doors [labeled Trash on left and Recycle on right] secured with stainless steel hinges and hardware
- Both doors are keyed alike and lockable
- All units are coated with zinc primer and polyester powdercoat finish (black on Trash, blue on Recycle)
- All hardware is zinc coated
- All units shipped assembled
- 5 Year warranty



Liner:

- Black, square polyethylene plastic liners with hand holes [2] included



287 SERIES THERMOPLASTIC - AVAILABLE COLORS



BLACK



RED



ORANGE



YELLOW



GREEN



BLACK GREEN



TEAL



BLUE



NAVY



PURPLE



BURGUNDY



BROWN



BEIGE



SANDSTONE



GRAY

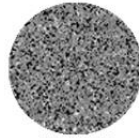

GRANITE



Park Warehouse LLC
 7495 W. Atlantic Ave., Suite #200-294
 Delray Beach, FL 33446
 888-321-5334

**Quality Commercial Site Furnishings for
 Municipalities, Schools & Property Managers**

Billing

Hector Gomez
 Town of Surfside - Public Works
 9293 Harding Avenue
 Surfside, FL 33154
 Phone: 7867781728

Shipping

Hector Gomez
 Town of Surfside - Public Works
 9293 Harding Avenue
 Surfside, FL 33154

Quote: Q221735

Quote Date **Quote Expiration**
 June 4, 2020 30 Days (07/04/2020)

Sales Rep: Rosealee x521
Ref#:

\$38,336.36

**If you receive a lower quote, please remember our
 best price guarantee!**

Description	SKU	Cost	Qty	Total
32 Gallon - Trash & Recycle Receptacle Combo - With Plastic Liner & Lids - With Security Doors - No Option	287tr180-1	\$1,224.00	30	\$36,720.00
Configuration: No Option		\$1,101.60		\$33,048.00

Discount	\$3,672.00
Subtotal	\$33,048.00
Shipping	\$2,975.00
Tax 7%	\$2,313.36
Total	\$38,336.36

Quote Note: LEAD TIME TO SHIP OUT IS 5 WEEKS

Attachment "C"

Oakley Standard Trash Receptacle

Sku: 450tr120

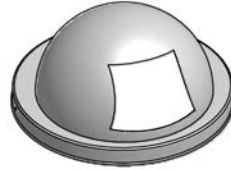

Dome Top (DT) Lid Option



Rain Cap (RC) Lid Option



Ash & Trash (AT) Lid Option



Flat Top (FT) Lid Option

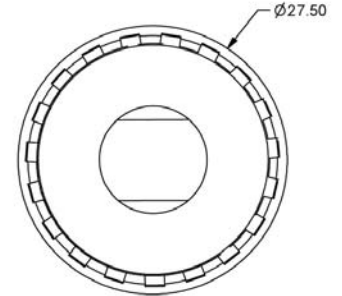

Top View

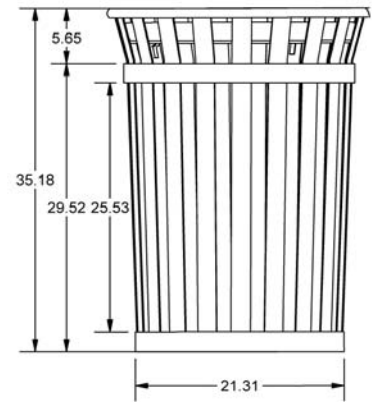

Front View

Dimensions represent can only
lid accounted for separately

Product Features

- Made from 1/8" X 2" galvanized steel slats
- Has 1" top tube
- Includes 1/8" x 2" steel horizontal bands
- TGIC Polyester Powder Coat outdoor finish
- Material is chemically prepared and zinc rich primed prior to paint
- Available in three standard colors: Black (PMS # 6C), Brown (PMS # 426C) or Green (PMS # 346C)
- Custom colors available upon request
- Unit comes Standard with 3 Stainless Steel Leveling Feet, Anchor Kit, and Lid Attachment Kit
- Black high density polyethylene rigid plastic liner
- 4 Lids options available

Dome Top (DT), Rain Cap (RC), Ash / Trash Top(AT) and Flat Top (FT)

	Capacity	Dimensions	Weight	Finishes
PAGE 326	36 gallons	27 1/2" dia x 35 1/4" high	95 lbs	Black (BK), Green (GN), Brown (BN)



287 SERIES THERMOPLASTIC - AVAILABLE COLORS

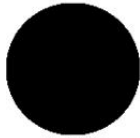

BLACK



RED



ORANGE



YELLOW



GREEN



BLACK GREEN



TEAL



BLUE



NAVY



PURPLE



BURGUNDY



BROWN



BEIGE



SANDSTONE



GRAY

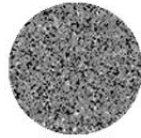

GRANITE



Park Warehouse LLC
 7495 W. Atlantic Ave., Suite #200-294
 Delray Beach, FL 33446
 888-321-5334

**Quality Commercial Site Furnishings for
 Municipalities, Schools & Property Managers**

Billing

Hector Gomez
 Town of Surfside - Public Works
 9293 Harding Avenue
 Surfside, FL 33154
 Phone: 7867781728

Shipping

Hector Gomez
 Town of Surfside - Public Works
 9293 Harding Avenue
 Surfside, FL 33154

Quote: Q221754

Quote Date **Quote Expiration**
 June 4, 2020 30 Days (07/04/2020)

Sales Rep: Rosealee x521
Ref#:

\$50,126.07
 If you receive a lower quote, please remember our
 best price guarantee!

Description	SKU	Cost	Qty	Total
Oakley Collection - Recycling Receptacle w/ Flat Top & Plastic Liner - Slatted Metal - 36 Gallon Capacity: 36 Gallon	450tr180-1	\$872.00 \$793.52	30	\$26,160.00 \$23,805.60
Oakley Standard - Round - Trash Receptacle - w/ Plastic Liner - Slatted Metal Capacity: 36 Gallon Lid Type: tbd Color : TBD ** Free shipping ***: Free shipping on qty of 60 quoted	450tr120-5	\$844.00 \$768.04	30	\$25,320.00 \$23,041.20

Discount	\$4,633.20
Subtotal	\$46,846.80
Shipping	\$0.00
Tax 7%	\$3,279.27
Total	\$50,126.07



Park Warehouse LLC

7495 W. Atlantic Ave., Suite #200-294

Delray Beach, FL 33446

888-321-5334

**Quality Commercial Site Furnishings for
Municipalities, Schools & Property Managers**

Quote Note: *** FREE SHIPPING ON QTY QUOTED OF 60*** Lead time to ship out is-4 weeks ** NO LIFT GATE SERVICE

Attachment "D"

TYPE 2

The CLAREMONT

Key features:

- Constructed with 97% pure Type 2 recycled plastic
- Offered in a variety of colors and panel options
- Attractive solution for recycling programs
- Opening identification and restrictive
- Rigid liner included

Available Colors:

plain panel colors



Material Aesthetics:

- Manufactured from high-grade of recycled HDPE
- Top-of-the-line pigments and UV inhibitors

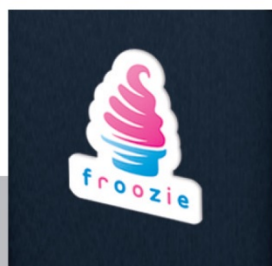

Overlay Logos

4 color printed logo or company name set in the panel of the furnishing.



Overlay Symbols

Help users identify waste streams visually with overlaid symbols. Available in small, medium and large sizes.

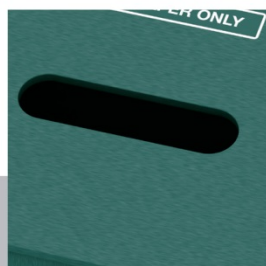

Restrictive Openings

Keep recycling streams from getting contaminated - all at no extra cost.



Opening IDs

Clearly labeled waste and recycling streams help identify openings and reduce cross contamination.



“Slow-Stay” Hinged Lid

Easily open and service bins without worrying about the lid slamming shut.



Seamlessly Built

Flush post-to-panel construction gives these units a clean, stylish appearance without sacrificing strength.

Tested Construction Methods:

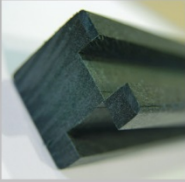

Dado Grooved Posts

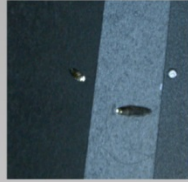

Pocket Screw Joinery



Marine-Grade Hardware



Levelers



Metal Reinforcements



Removable Liner

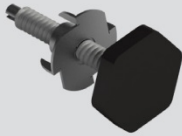

Adjustable Levelers

Ensures longevity of your unit by giving product stability on uneven surfaces.



Casters

Add casters for easy mobility. Regular and lockable casters available.

Configurations

Single

Double

Triple

Topload



*Available in 12-32 Gallon Capacities

Single

Double

Triple

Size

Dimensions

12 Gallon 20"W x 15"D x 30"H
 26 Gallon 29"W x 20"D x 31"H
 32 Gallon 26"W x 20"D x 39"H

Size

Dimensions

12 Gallon 29"W x 15"D x 30"H
 26 Gallon 48"W x 20"D x 31"H
 32 Gallon 42"W x 20"D x 39"H

Size

Dimensions

12 Gallon 43"W x 15"D x 30"H
 26 Gallon 71"W x 20"D x 31"H
 32 Gallon 63"W x 20"D x 39"H

TYPE-2 Material

Type-2 Material is impervious to insects, moisture and mold, meaning it won't rot, splinter or become dinner for pests as wood often does. Added UV inhibitors keep its colors stable while bonding agents create complete molecular linkage for optimum structural integrity.

- Manufactured from high-grade of recycled HDPE, and unlike other plastic recycling centers, contains no foam fillers
- Top-of-the-line pigments and UV inhibitors are used to maintain color for decades



Warranty

Nex-Terra offers a three year limited warranty on all of our products to be free from defects in workmanship and/or material(s). Nex-Terra makes no warranty with respect to either the merchantability of our products, or their suitability for any specific purpose or use.



35 Frost Street, Brattleboro, VT 05301

800.664.5340
sales@recycleaway.com

Customer Information

Buyer: Town of Surfside 9293 Harding Ave Surfside, FL 33154	Bill To: Town of Surfside 9293 Harding Ave Surfside, FL 33154	Ship To: Town of Surfside 9293 Harding Ave Surfside, FL 33154
--	--	--

(786) 778-1728
hgomez@townofsurfsidefl.gov

Shipping and Delivery Notes:
Standard shipping is dock-to-dock and does not include lift-gate, inside delivery, or other special services and assumes the use of a 53' delivery truck. Please let us know if you have special delivery requirements.

Lead time for these containers is : **4 - 6 Weeks**

Quote #0048638

ACCOUNT REP Amanda Gilbert

QUOTE DATE	QUOTE AMOUNT	QUOTE EXPIRES
June 2, 2020	\$56,280.00	July 3, 2020

ITEM CODE	QTY	DESCRIPTION	UNIT PRICE	TOTAL
N6-19202045DP1	30.00	Claremont Double Recycling Station Size: 45 Gallon Left Color: Left Opening: Left Label and Symbol: Right Color: Right Opening: Right Label and Symbol: Website price \$2,048	\$1,876.00	\$56,280.00
<i>Subtotal</i>				\$56,280.00
<i>Tax</i>				\$
<i>Shipping</i>				\$2982.03
Total				\$59,262.03

- To approve your quote via **FAX**: Print, Sign and Fax this page to **888.506.0210**
- To approve your quote via **USMail**: Print, Sign and Mail this page to **Recycle Away, 35 Frost Street, Brattleboro, VT 05301**
- To approve your quote via **Email**, fill out download to us at **sales@recycleaway.com**

Signature: _____

Email: _____

Company: _____

PO# (Optional): _____

Credit Card# (Optional): _____

Exp. / / 3-digit-code: _____

Damages & Returns

Damages - All shipments are insured against damage in transit. If your shipment shows any sign of visual damage, it should be noted on the freight bill or receiving ticket and signed by the driver. If damage to the shipment is not visible until the carton is opened, please keep all of the packing materials and the original carton. In either case, please notify Recycle Away within five days.

Returns - If your order is damaged in shipment, we will either issue credit for the product and the shipping costs, or ship a replacement product at no cost for the product and shipping. If you need to return the purchase for any other reason please notify us within five days. Please note that special orders are non-refundable. The customer must pay for the return shipping and a re-stocking fee of 25, for returned items. The items must be returned in their original cartons in new condition.

35 Frost Street | Brattleboro, VT 05301 | Tel : 800.664.5340 | Fax: 888.506.0210 | Email: sales@recycleaway.com

Attachment "E"



The Manchester Collection

- Manufactured from pure high-grade of recycled HDPE, and unlike other plastic recycling centers, contains no foam fillers. Top-of-the-line pigments and UV inhibitors are used to maintain consistent in the most demanding outdoor environments. The product is virtually maintenance free and never needs painting, never splinters and never becomes food for termites. The units are constructed to last decades, and include pocket screw construction and marine grade hardware throughout.
- Serviced via a stainless steel piano hinged side door for ease of access, and all hinges are marine grade and thus rust resistant.
- Each unit comes with heavy duty liners with handles for easy servicing and lifting.
- Designed for both indoor and outdoor use, and meets all LEED requirements for recycled content, are ADA-compliant and fire safe.
- Our lumber lasts for decades and thanks to our full line of engineered products built with commercial-grade building techniques, the furnishings themselves last just as long.
- The lumber won't absorb moisture, which can lead to rotting and won't harbor insects. It offers many of the characteristics of wood but requires virtually no maintenance!

The Manchester Collection

Construction Features:



Dado Grooved Posts



Pocket Screw Joinery



Marine-Grade Hardware



Piano Hinged Door



Metal Reinforcements



Removable Liner



Container Options:



Casters

Add casters for easy mobility. Regular and lockable casters available.



Cam Locks

To protect valuable streams add cam locks to prevent theft.



Flap Door

Add a basic flap door to fully encase waste contents from view and reduce pest entry



Panel Options

Available with plain or beadboard panels



The Manchester Collection



Design your own bin
in four easy steps:

Choose Your Colors:



Choose Your Openings:

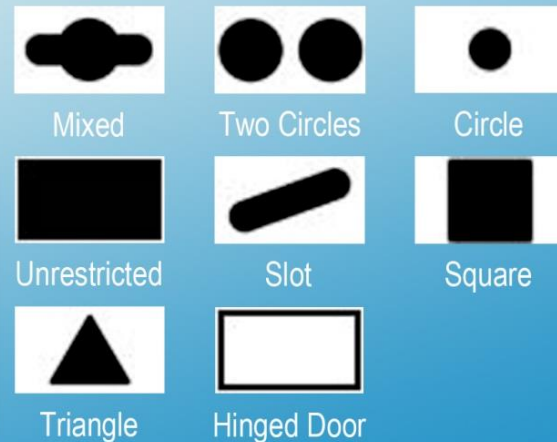

Choose Your Symbols:



Choose Your Labels:



The Manchester Collection



Single Sideload

Size	Dimensions	SKU
26 gallon	39"w × 21"d × 31"h	N3-19201926P2
32 gallon	39"w × 21"d × 36"h	N3-19201932P2
38 gallon	46"w × 24"d × 31"h	N3-19201938P2
45 gallon	46"w × 24"d × 36"h	N3-19201945P2
55 gallon	46"w × 24"d × 40"h	N3-19201955P2

Single-Slim Sideload

Size	Dimensions	SKU
38 gallon	46"w × 24"d × 31"h	N3-19201938SP2P2
45 gallon	46"w × 24"d × 36"h	N3-19201945SP2P2
55 gallon	46"w × 24"d × 40"h	N3-19201955SP2P2



Double Sideload

Size	Dimensions	SKU
26 gallon	38"w × 20"d × 34"h	N3-19201926DP2
32 gallon	38"w × 20"d × 36"h	N3-19201932DP2
38 gallon	50"w × 24"d × 34"h	N3-19201938DP2
45 gallon	50"w × 24"d × 37"h	N3-19201945DP2
55 gallon	50"w × 24"d × 41"h	N3-19201955DP2



The Manchester Collection



Double-Slim Sideload

Size	Dimensions	SKU
38 gallon	50"w × 24"d × 34"h	N3-19201938DSP2P2
45 gallon	50"w × 24"d × 37"h	N3-19201945DSP2P2
55 gallon	50"w × 24"d × 41"h	N3-19201955DSP2P2

Triple Sideload

Size	Dimensions	SKU
26 gallon	38"w × 20"d × 34"h	N3-19201926TP2
32 gallon	38"w × 20"d × 36"h	N3-19201932TP2
38 gallon	50"w × 24"d × 34"h	N3-19201938TP2
45 gallon	50"w × 24"d × 37"h	N3-19201945TP2
55 gallon	50"w × 24"d × 41"h	N3-19201955TP2



Triple-Slim Sideload

Size	Dimensions	SKU
38 gallon	50"w × 24"d × 41"h	N3-19201938TSP2P2
45 gallon	50"w × 24"d × 44"h	N3-19201945TSP2P2
55 gallon	50"w × 24"d × 48"h	N3-19201955TSP2P2





35 Frost Street, Brattleboro, VT 05301

800.664.5340
sales@recycleaway.com

Customer Information

Quote #0048641
ACCOUNT REP Amanda Gilbert

Buyer: Town of Surfside 9293 Harding Ave Surfside, FL 33154	Bill To: Town of Surfside 9293 Harding Ave Surfside, FL 33154	Ship To: Town of Surfside 9293 Harding Ave Surfside, FL 33154
--	--	--

(786) 778-1728
hgomez@townofsurfsidefl.gov

Shipping and Delivery Notes:
Standard shipping is dock-to-dock and does not include lift-gate, inside delivery, or other special services and assumes the use of a 53' delivery truck. Please let us know if you have special delivery requirements.

Lead time for these containers is : **4 - 6 Weeks**

QUOTE DATE	QUOTE AMOUNT	QUOTE EXPIRES
June 2, 2020	\$55,980.00	July 3, 2020

ITEM CODE	QTY	DESCRIPTION	UNIT PRICE	TOTAL
N3-19201945DP2	30.00	Manchester Sideload Double Recycling Station Size: 45 Gallon Left Color: Left Opening: Left Label and Symbol: Right Color: Right Opening: Right Label and Symbol: Website price \$2,038	\$1,866.00	\$55,980.00
			<i>Subtotal</i>	\$55,980.00
			<i>Tax</i>	\$
			<i>Shipping</i>	\$3685.75
			Total	\$59,665.75

- To approve your quote via **FAX**: Print, Sign and Fax this page to **888.506.0210**
- To approve your quote via **USMail**: Print, Sign and Mail this page to **Recycle Away, 35 Frost Street, Brattleboro, VT 05301**
- To approve your quote via **Email**, fill out download to us at **sales@recycleaway.com**

Signature: _____

Email: _____

Company: _____

PO# (Optional): _____

Credit Card# (Optional): _____

Exp. / / 3-digit-code: _____

Damages & Returns

Damages - All shipments are insured against damage in transit. If your shipment shows any sign of visual damage, it should be noted on the freight bill or receiving ticket and signed by the driver. If damage to the shipment is not visible until the carton is opened, please keep all of the packing materials and the original carton. In either case, please notify Recycle Away within five days.

Returns - If your order is damaged in shipment, we will either issue credit for the product and the shipping costs, or ship a replacement product at no cost for the product and shipping. If you need to return the purchase for any other reason please notify us within five days. Please note that special orders are non-refundable. The customer must pay for the return shipping and a re-stocking fee of 25, for returned items. The items must be returned in their original cartons in new condition.

35 Frost Street | Brattleboro, VT 05301 | Tel : 800.664.5340 | Fax: 888.506.0210 | Email: sales@recycleaway.com

Attachment "F"



The Vancouver

Add a burst of color to your community's recycling & waste program with the Vancouver. This round metal container accommodates up to three streams and comes with a sturdy plastic lid and durable body to withstand the elements. The Vancouver will be a pivotal part of keeping your community's outdoor space clean and free of litter.

Best selection, lowest prices.

Call us for Quantity Discounts and Custom Designs!

800.664.5340 www.recycleaway.com

FEATURES

- Array of configurations allow collection for up to three streams
- The pattern aids in stream identification by revealing the brightly colored liners within
- Rigid plastic liners enforce stability
- Ergonomic handles on liners allow for seamless servicing

LID OPTIONS

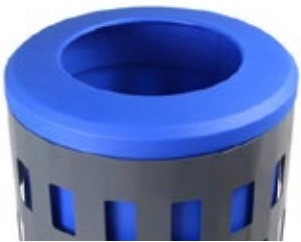

Single - Blue

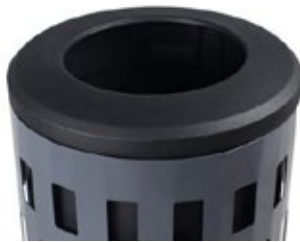

Single - Black



Double



Triple

Flat Top Dimensions: 23" Diameter x 37.5" H



Canopy - Single



Canopy - Double



Canopy - Triple

Canopy Lid Bin Dimensions: 23" Diameter x 46" H



Dome - Black



Dome - Blue

Dome Lid Bin Dimensions: 23" Diameter x 49" H

SPECIFICATIONS

CAPACITY
45 Gallon

STOCK BODY COLOR

● Gray

STOCK LINER COLORS

● Blue ● Green

● Black

*Green Only Available
for Triple

Best selection, lowest prices.

Call us for Quantity Discounts and Custom Designs!

800.664.5340 www.recycleaway.com



35 Frost Street, Brattleboro, VT 05301

800.664.5340
sales@recycleaway.com

Customer Information

Buyer: Town of Surfside 9293 Harding Ave Surfside, FL 33154	Bill To: Town of Surfside 9293 Harding Ave Surfside, FL 33154	Ship To: Town of Surfside 9293 Harding Ave Surfside, FL 33154
--	--	--

(786) 778-1728
hgomez@townofsurfsidefl.gov

Shipping and Delivery Notes:
Standard shipping is dock-to-dock and does not include lift-gate, inside delivery, or other special services and assumes the use of a 53' delivery truck. Please let us know if you have special delivery requirements.

Lead time for these containers is : **4 - 6 Weeks**

Quote #0048642

ACCOUNT REP Amanda Gilbert

QUOTE DATE	QUOTE AMOUNT	QUOTE EXPIRES
June 2, 2020	\$47,820.00	July 3, 2020

ITEM CODE	QTY	DESCRIPTION	UNIT PRICE	TOTAL
VANCOUVER - SINGLE - CANOPY - BLACK, VANCOUVER - SINGLE - CANOPY - BLUE	30.00	The Vancouver Trash & Recycling Bin Combo with Canopy Website price \$1,790	\$1,594.00	\$47,820.00
			<i>Subtotal</i>	\$47,820.00
			<i>Tax</i>	\$
			<i>Shipping</i>	\$1712.00
			Total	\$49,532.00

- To approve your quote via **FAX**: Print, Sign and Fax this page to **888.506.0210**
- To approve your quote via **USMail**: Print, Sign and Mail this page to **Recycle Away, 35 Frost Street, Brattleboro, VT 05301**
- To approve your quote via **Email**, fill out download to us at **sales@recycleaway.com**

Signature: _____

Email: _____

Company: _____

PO# (Optional): _____

Credit Card# (Optional): _____

Exp. / / 3-digit-code: _____

Damages & Returns

Damages - All shipments are insured against damage in transit. If your shipment shows any sign of visual damage, it should be noted on the freight bill or receiving ticket and signed by the driver. If damage to the shipment is not visible until the carton is opened, please keep all of the packing materials and the original carton. In either case, please notify Recycle Away within five days.

Returns - If your order is damaged in shipment, we will either issue credit for the product and the shipping costs, or ship a replacement product at no cost for the product and shipping. If you need to return the purchase for any other reason please notify us within five days. Please note that special orders are non-refundable. The customer must pay for the return shipping and a re-stocking fee of 25, for returned items. The items must be returned in their original cartons in new condition.

35 Frost Street | Brattleboro, VT 05301 | Tel : 800.664.5340 | Fax: 888.506.0210 | Email: sales@recycleaway.com



LAST
REVISION
05/19/2020

DESCRIPTION:

FINALIZED BEACH END AT 95TH STREET DEVELOPED IN 2014. AERIAL
FROM EAST FACING WEST



TOWN OF SURFSIDE

95TH STREET BEACH-END

SCALE:
N.T.S.

SHEET
1 of 1

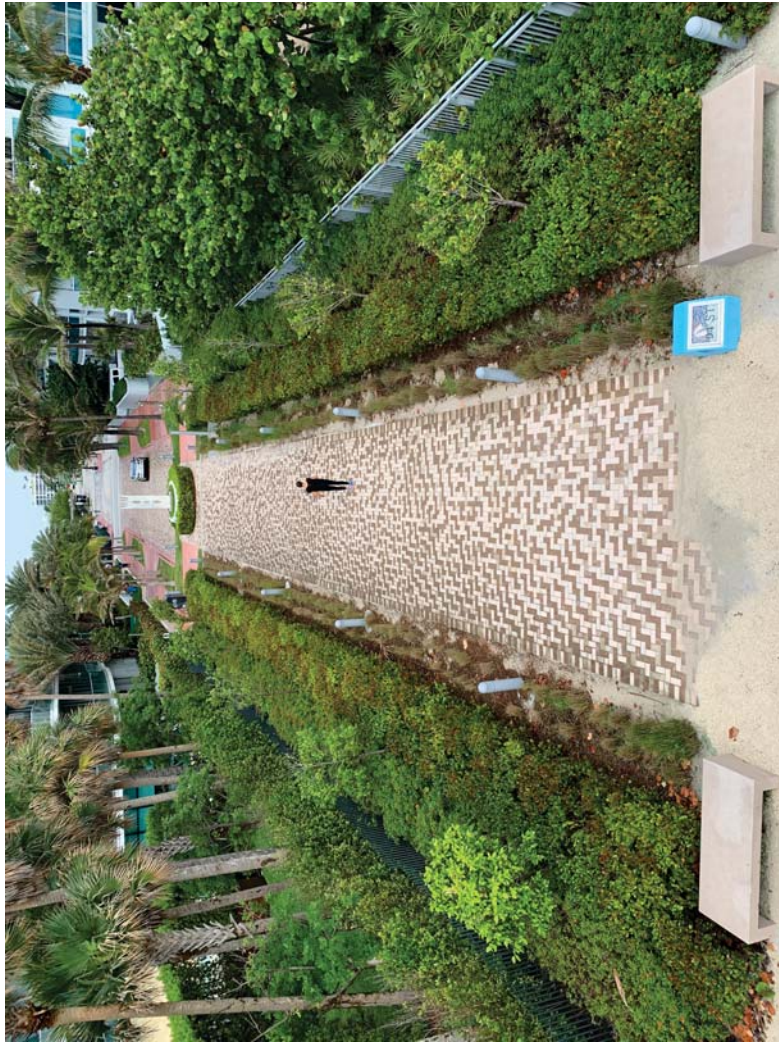

LAST
REVISION
05/19/2020

DESCRIPTION:
FINALIZED BEACH END AT 94TH STREET DEVELOPED IN 2016. AERIAL
FROM EAST FACING WEST



TOWN OF SURFSIDE

94TH STREET BEACH-END

SCALE:
N.T.S.

SHEET
1 of 1

TOWN OF SURFSIDE

Public Works Department

“92nd Street Beach End Improvements Phase I”

March 19, 2020

9293 HARDING AVENUE,
SURFSIDE, FL 33154
PHONE: (305) 861-4863

Prepared By:



Public Works Department



OVERVIEW

During fiscal year 2019-2020, the Town Commission approved expenditures for the improvements of 92nd Street Beach End. Current fiscal year account number for the project is 301-4400-541-63-95. The project is to be performed in two phases. Phase I is the development of areas east of bulkhead which is the current concrete band where current stairs exist. Phase I will convert areas east of bulkhead ADA compliant while beautifying the extents. ADA compliance will be obtained by creating a sloped walkway from the bulk head to the hardpack similar to 94th Street beach end developed in 2017. The walking surface will be paver set on limerock base with a perimeter concrete band. The walkway will be 15 feet wide by approximately 90 feet long. Paver specifications are provided in **Attachment A** – “*Material Specifications*”. Phase I will include the development of two landscape isles each 17 feet wide by approximately 90 feet long along each side of the paver walkway. Currently, there are 10 existing coconut palms that will be re-configured to 5 on each side of equal spacing. The ground cover will consist of *Ficus microcarpa* (green island ficus) and *Clusiaceae* (clusia) which are native Florida species approved by Florida Department of Environmental Protection (FDEP) and are of high resiliency for beach conditions. Refer to **Attachment B** – “*Project Drawings for Configuration*”.

Additionally, a drainage system will be installed to provide drainage of shower run-off. The drainage system will consist of a yard drain structure along with 40 linear feet of exfiltration trench. The drainage will be placed into operation with the current shower but will be connected to any Phase II development at a later time. Refer to **Attachment B** – “*Project Drawings for Configuration*” for a Civil Schematic drawing. Due to the nature of the project on State jurisdiction land, fill from on-site needs to be used for the development of lands. The Town has stock-piled sand fill on a private property located at 8800 Collins Ave and along with fill excavated from the exfiltration trench, will attempt to balance the site as required for the ADA compliance grade. Additionally, the grading of the north side of the Phase I will allow for additional fill for use. An additional 50 cubic yard of beach quality sand and 30 cubic yards of limerock will need to be purchased to achieve a balanced site and provide stabilization for pavers.

Lastly, extents of the site will be defined using an aluminum picket style fence along both running perimeters on the north and south side of the property. Bollard lighting with amber fixtures will be installed on each side of the walkway for sundown illumination. The lighting fixtures are the same specification as 94th Street beach end and are amber to allow for turtle lighting approval. Amber lighting does not impact turtles since they are of a light frequency not detected by turtles. A complete project schedule can be found in **Appendix C** - *Project Schedule and Project Budget Estimate*”. This project will be performed internally by the Public Works Department along with specialty contractors managed by the Department. Project management will be performed by the Public Works Department. Project Budget Estimate has a schedule column outlining the procurement process for each activity. The schedule start date is tentative permit approval and commission approval of plan. At this time, Phase II is not budgeted for but left over funds can be carried over for development.



Attachment A
“Material Specifications”.



Town of Surfside Public Works Department

Product Specification Sheet

Paver Walkway



QUARTZSTONE 12X12

PRODUCT CODE: PV21440

THICKNESS: 2-3/8" (60MM)

DIMENSIONS: 12" X 12"

SF PER CUBE: 120

CUBE WEIGHT: 3120

Note: 10 week lead time on product



Town of Surfside Public Works Department

Product Specification Sheet

Landscape Specification



CLUSIA 7 GALLON



GREEN ISLAND FICUS



TRIM ALL PALM TREES REMOVE PALM TREES TO ADJACENT LOCATION FOR STORAGE.

INSTALL 10 COCONUT PALMS BACK TO 92ND STREET AS PER PLANS.



Town of Surfside Public Works Department

Product Specification Sheet

North and South Fence Detail

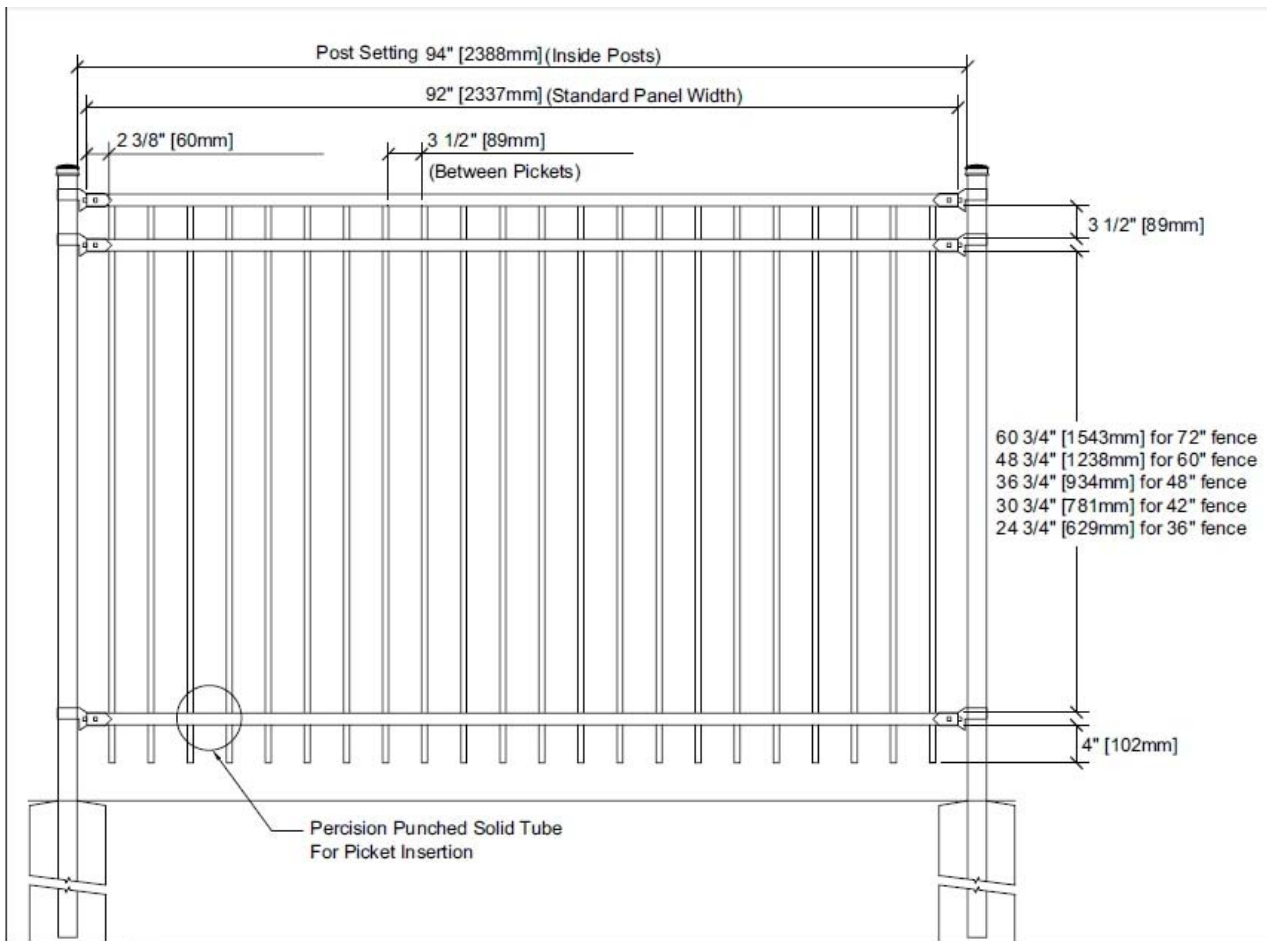



Town of Surfside Public Works Department

Product Specification Sheet

Bollards



Amber Lighting for Sea Turtle Conditions

Product Overview

Highlights:

- Engineered and manufactured in Wisconsin, USA from domestic and imported components
- ETL Certified: Conforms to UL STD 1598 & CSA STD C22.2 # 250.0 for wet locations
- L70 calculated LED life over 136,500+ hours
- Drivers are 0-10v dimming standard
- Four light engine options from 1,443 – 5,421 lumens, custom options available upon request
- Premium high-output Chip-On-Board (COB) LEDs in 5700K, 5000K, 4000K, 3000K and 2700K options, custom color temps available upon request
- Minimum CRI of 90, custom CRI available

Common Applications:

- Building entrances
- Path and walkways
- Architectural and landscape lighting
- Accent and general lighting

Light Engine Warranty:

- 5-year standard limited warranty on all light engine components
- Accessories and adders covered by separate OEM supplier warranties

Note: 8 week lead time on all amber products



Attachment B
“Project Drawings for Configuration”

CERTIFICATE OF AUTHORIZATION #: 26074
 P.E. #: 14170
 12355 SW 129 CT, SUIT 4
 MIAMI, FLORIDA 33186
 PHONE: (305) 251-9177
 FAX: (305) 251-8372
ALFREDO M. CARBONELL, P.E., Inc.

NO.	DATE	REVISIONS

TOWN OF SURSIDE
 Client:
 Project:
92ND STREET BEACH ACCESSIBLE PATHWAY
 9293 HARDING AVENUE SURSIDE, FL 33154

PROPOSED SITE PLAN
 Plan Description:
 Sheet:

FLA. REG. P.E. # 14170
 Drawn by:
ALFREDO M. CARBONELL
 Checked by:
ENICK FLORIDO
 Date:
SEPTEMBER 10, 2018
 Scale:
AS SHOWN
 Job No.:
2018-0910

Sheet:
A.100
 X of X Sheets



SCOPE OF WORK

1. BEACH ACCESS AT 92ND STREET EAST OF COLLINS AVENUE.
2. PROPOSED 10' WIDE CONCRETE WALKWAY WITH 8" RISERS OF 48" HEIGHT EACH TO COVER CHANGE IN LEVEL OF 38" BETWEEN STREET AND DIRT WAY.
3. PROPOSED NEW 1:22 RAMP FOR WHEELCHAIR ACCESSIBILITY SURROUNDING EXISTING PALM TREES.
4. NEW GUARDRAIL WHERE CHANGE IN LEVEL GREATER THAN 30" HIGH.

PROPOSED SITE PLAN
 SCALE: 1/4" = 1'-0"

CERTIFICATE OF AUTHORIZATION #: 26074
 P.E. #: 14170
 12355 SW 129 CT, SUIT 4
 MIAMI, FLORIDA 33186
 PHONE: (305) 251-9177
 FAX: (305) 251-8372

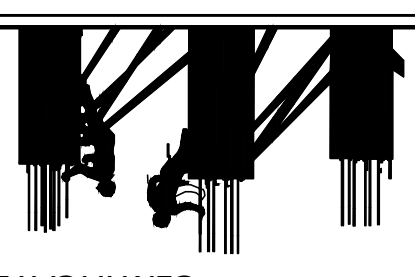

ALFREDO M. CARBONELL, P.E., Inc.

NO.	DATE	REVISIONS

Client: TOWN OF SURFSIDE
 Project: 92ND STREET BEACH ACCESSIBLE PATHWAY
 9293 HARDING AVENUE SURFSIDE, FL 33154

Plan Description: PROPOSED SITE PLAN

Sheet:
 FLA. REG. P.E. # 14170

Designed by: ALFREDO M. CARBONELL
 Drawn by: ENICK FLORIDO
 Review & Seal: ALFREDO M. CARBONELL
 Date: SEPTEMBER 10, 2018
 Scale: AS SHOWN
 Job No.: 2018-0910

Sheet: A.100
 X of X Sheets



SCOPE OF WORK

1. BEACH ACCESS AT 92ND STREET EAST OF COLLINS AVENUE.
2. PROPOSED 10' WIDE CONCRETE WALKWAY WITH 8" RISERS OF 48" HEIGHT EACH TO COVER CHANGE IN LEVEL OF 38" BETWEEN STREET AND DIRT WAY.
3. PROPOSED NEW 1:28 RAMP FOR WHEELCHAIR ACCESSIBILITY SURROUNDING EXISTING PALM TREES.
4. NEW GUARDRAIL WHERE CHANGE IN LEVEL GREATER THAN 30" HIGH.

PROPOSED SITE PLAN
 SCALE: 1/4" = 1'-0"

PAVERS (REFER TO SPECIFICATION)

6"X4" CONCRETE BAND

SAND BASE FOR PAVERS

12" LIMEROCK BASE

SOIL SUBGRADE - ZERO SLOPE

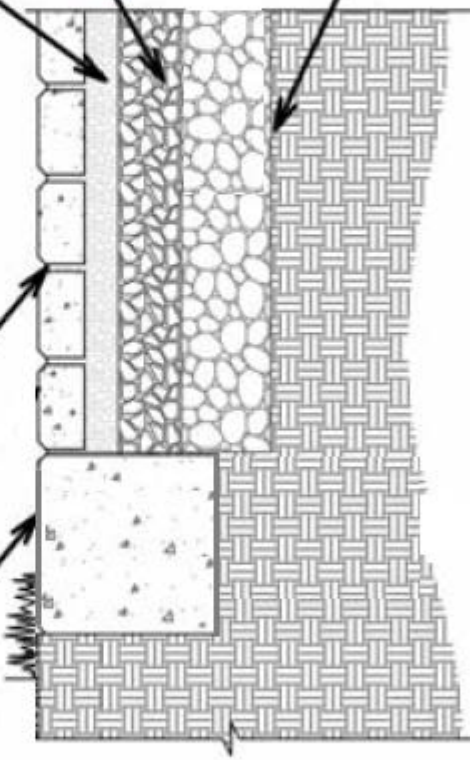

CIVIL SCHEMATIC DRAWING
N.T.S
03/19/2020

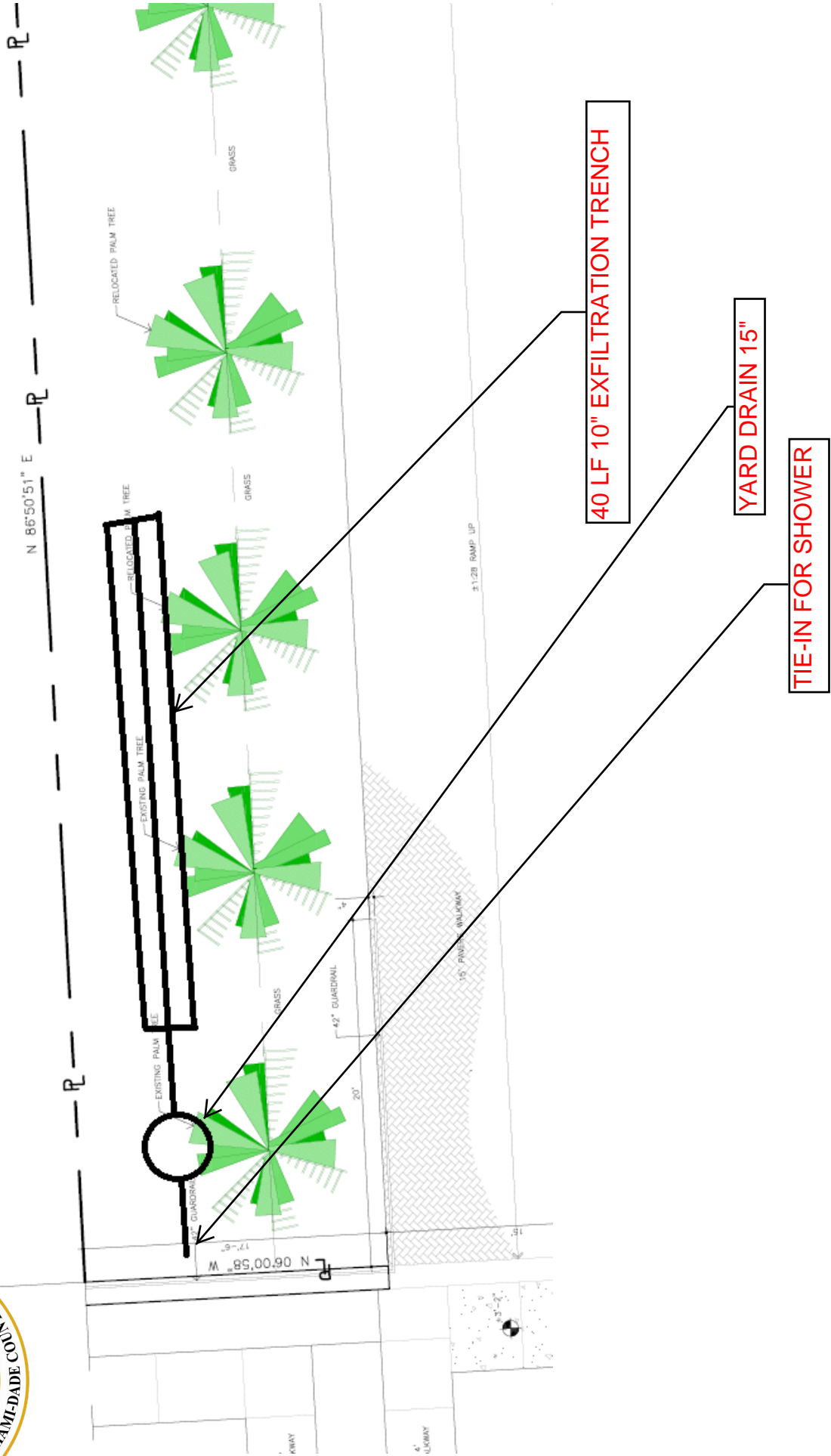
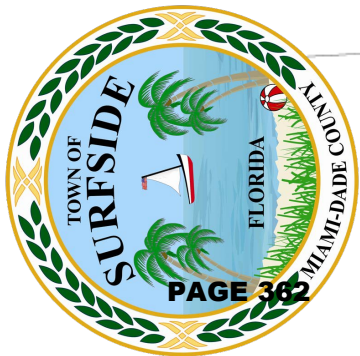



Attachment C
“Project Schedule and Project Budget Estimate”.



9th and Street Beach End Project

PAGE 364

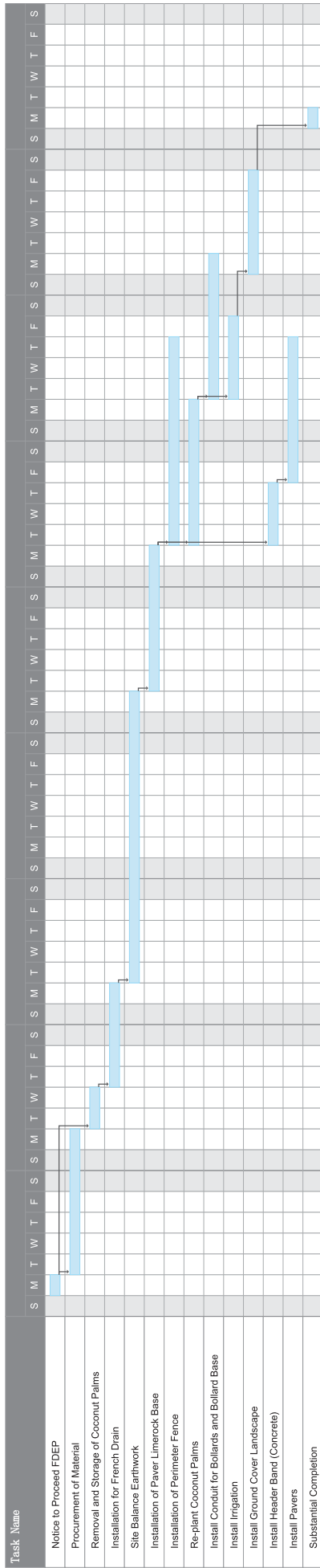



Town of Surfside
Public Works Department
92nd Street Beach End Project Estimate

Item Number	Activity	Cost	Procurement Method	PO
1	Landscaping (Full Scope)	\$14,000.00	Brightview Contract Schedule of Value	YES
2	Civil (Drainage Material)	\$6,000.00	Material Purchase within Spending Authority	YES
3	Perimeter Fencing	\$5,200.00	Material Purchase within Spending Authority	YES
4	Electrical (Bollards)	\$13,500.00	Procurement of Contractor Lowest Bidder	YES
5	Paver Material	\$7,000.00	Material Purchase within Spending Authority	YES
6	Paver Installation	\$8,000.00	Procurement of Contractor Lowest Bidder	YES
7	Earthwork (Fill)	\$6,000.00	Material Purchase within Spending Authority	NO
8	Equipment Rental	\$6,500.00	Equipment Purchase within Spending Authority	NO
9	Concrete Header Band	\$3,500.00	Procurement of Contractor Lowest Bidder	YES
10	Labor for Civil (Drainage)	\$7,500.00	Staff Resources	NO
11	Labor for Fence Installation	\$3,000.00	Staff Resources	NO
12	Labor for Earthwork	\$8,400.00	Staff Resources	NO
13	Survey	\$6,000.00	Engineer of Record	YES
Total Project Estimated Cost		\$94,600.00		



TOWN OF SURFSIDE

COMMUNICATIONS CONTRACTS

Public Information Representative Contract – Pinzur Communications

Monthly Fee: \$7,500.00

Potential Additional Fees: Annual SurveyMonkey subscription (\$408), printing of signs and materials as needed for community outreach campaigns (cost varies depending on number of signs, size, color, etc.)

Staff assigned to contract: Rachel Pinzur, 1 additional PIR staff member, videographer and graphic artist (all included in monthly fee)

Monthly Fee hours dedicated per month:

Under current contract, there is not a limit on hours. Prior to the coronavirus crisis, we routinely worked an average of 55 hours per week on Town of Surfside. This is all Pinzur Communications staff combined – often more on weeks with video production for Ch. 663. During crises, we have averaged 12 to 15 hours per day.

Responsible for: Provides support to all Town departments including police, and is responsible for communication to residents and press

Monthly Fee scope of work:

- Draft annual communications plan and strategy, as well as execute plan
- Draft key messages and FAQ documents as necessary
- Provide strategic PR counsel, as necessary, on matters of importance to Town residents
- Transform Channel 663 into a more lifestyle-focused channel that will appeal more to Surfside residents (note, most videos taken down for now as majority of focus of channel is coronavirus) Tasks include:
 - Create schedule that includes topic and segment ideas (i.e. Surfside 7, business district highlights, hurricane preparedness, events, important topics for residents, etc.)
 - Reach out to subjects, businesses, department directors, etc. to notify them in advance of filming

- Develop a TV training guide to help educate the interviewee about what to expect for filming, talking points, etc.
 - Schedule and film videos
 - Edit each video, which takes several days. Videos have unlimited use and can also be used for media opportunities
 - Upload videos to Channel 663 and make necessary edits/additions to content on Ch. 663 throughout the month
 - Develop slides for Ch. 663
- Implement public awareness campaigns (i.e. recycling workshop, government academy, Town resiliency measures, upcoming projects, etc.) as well as help boost citizen engagement
 - Monitor conversations being held about Surfside including Nextdoor for example to further direct communications strategy; draft content for each month and regularly post updates to keep residents informed of important information, events, etc.; respond to residents' public and private questions on platform, as well as via emails and SeeClickFix
 - Develop and design flyers and graphics for be used in various communication (i.e. community bulletin boards, Nextdoor, hands outs for residents, etc.)
 - Receive feedback from residents on preferred mode of communication in order to continually enhance communication – survey conducted a year ago; new survey going out next week
 - Assist with outreach to key stakeholders and the procurement of experts for partnerships
 - Continue to reach out to neighboring municipalities to form beneficial partnerships and share best practices
 - Produce Town e-blasts to ensure messages are consistent; continually keep residents engaged and informed of important information and updates; assist Police with emergency alerts to residents
 - Responsible for overseeing, drafting and/or editing any communication that goes to residents, such as door hangers, brochures, etc.
 - Draft press releases and media pitches; regularly works with press to provide information, photos and video needed
 - Regularly contributes to town gazette including town manager and mayor letters, articles, COVID crisis
 - Regularly add and manage information on the town website
 - Respond to resident concerns on SeeClickFix; work with various departments to research answers

IT Services Contract – CGA

Communications tasks only

- Monthly Fee:** \$2,280.00 (part of \$11,031.31 monthly IT retainer)
- Staff assigned to contract:** Adrian Santaella, Media Specialist Part Time dedicated to the Town of Surfside as needed for website updates.
- Potential Additional Fees:** \$238.29 per broadcasting event (Jose Feliz) – including setup, AV during meeting, posting after the meeting is over. Average Commission Meetings are 4 hours (30 min setup, 3-hour meeting, 30 min broadcasting of video)
- Monthly Fee hours dedicated per month:**
20 hours (Adrian Santaella)
- Monthly Fee Brief scope of work:**

Services provide by Adrian (part of overall IT retainer)

- Hosting the Town Website, ensuring Website ADA Compliance and up to 20 hours of Website posts and updates

Services provide by Jose (paid per meeting)

- Recording and Broadcasting all Public Meetings

Services provide by Jose (part of overall IT retainer)

- Closed Caption for Channel 663 and Video Streaming
- Keeping SCALA up to date (Town Broadcasting)

Production of Town Gazette Services Contract – Mediatech Miami, LLC

Monthly Fee: Up to \$5,800 (professional services, \$1,600; printing, \$3,800; mail processing fee, \$395). Gazette is approximately 16 pages.

Potential Additional Fees: Non-Gazette projects and programs are charged at \$85.00 per hour with a \$100 minimum. Potential additional services include: business cards; shuttle bus maps; standard envelopes; election publications, cards, folders; applications forms and flyers

Staff assigned to contract: Cory Gittner/Mediatech Miami, LLC.

Monthly Fee hours dedicated per month:

Estimated 20 hours for Gazette production at \$85.00 per hour (\$1,600)

Monthly Fee Brief scope of work: (All work overseen by staff)

- Graphic design for Gazette
- Gazette layout, including incorporation of external advertising
- Gazette proofs and revisions
- Gazette prepress and production, digital version
- Gazette Town mail list
- Printing and mailing management
- Photography at Town events and Commission meetings
- Select writing and AP Style editing on blurbs for the Gazette, most content is provided by staff across departments
- Additional services as described in 'Potential Additional Fees'



Services contracted for the Tourist Bureau have been funded by the Resort Tax and are overseen by the Tourist Board.

Marketing Services for the Tourist Bureau Contract – Jacober & Associates

Monthly Fee: Monthly retainer fee for 2nd year of three-year agreement is \$13,485.

Potential Additional Fees: Requests outside retainer scope of services. Overages for exceeding 93+ hours billed at \$145.00.

Staff assigned to contract: Dedicated Account Executive, Luisa Jimenez. Work performed by several members of Jacober Creative team.

Monthly Fee hours dedicated per month:

93 hours included in retainer.

Monthly Fee Brief scope of work: (All work overseen by staff)

- Visitor website www.visitsurfsidefl.com
- Website maintenance and content updates
- Editorial work including copywriting, dedicated blogs, advertorials
- Monthly newsletters and e-marketing
- Social media posts and strategy on Instagram, Facebook, Twitter
- All graphic design needs for tourism related content and special events like Third Thursdays, Paddletopia, First Fridays
- Calls and meetings with Surfside team
- Reports and Tourist Board updates
- Advertising strategy for social media and Google including media buys
- Ad creation

General Communications Information

www.TownofSurfsideFL.gov

- Platform
 - Sitefinity (<https://www.progress.com/sitefinity-cms>)
- Hosting Provider
 - CGA
- Design
 - Adrian Santaella (CGA)
- Content
 - Adrian Santaella (CGA) / Rachel Pinzur (Pinzur Communications) / Town Clerk, Parks and Req, Tourism, Police (Surfside)
- Web Support
 - Helpdesk <helpdesk@townofsurfsidefl.gov>

www.VisitSurfsideFL.com

- Platform
 - Django
- Hosting Provider
 - Jacober
- Design
 - Jacober Creative
- Content
 - Jacober Creative
- Web Support
 - Jacober Creative & Tourism Director

Internal Staff Communications Breakdown (excludes contractors).

- **Assistant Town Manager:** Designated staff member who oversees town website and public information. On the website front is supported by Project and Contract Manager and Tourism Director on weekly check in calls, project updates.
**COVID-19 Functioning Role: Position vacant. During COVID-19, overview duties related to Town website organization and content production have been assumed by a designated member of the Town Commission.*
- **Tourism Director:** External communications related to tourism, marketing services, international messaging. Also performs content updates to Town website. Manages business district list. Holds degree in Public Relations and Marketing.
**COVID-19 Functioning Role: Works as Emergency Communications Lead and serves on COVID-19 Task Force. Helps perform website updates. Hotels and Business District liaison. Part of Incident Command.*

- **Resiliency Officer:** Reviews and provides comment on communications related to sustainability and resiliency. Provides other communications support as directed.
**COVID-19 Functioning Role: Primary role is COVID-19 Task Force coordinator. Also assists with the following communications functions: helps identify information to share through Town communication channels; reviews COVID-19 content produced for eblasts, website and special Gazettes; occasionally drafts content if needed. Part of Incident Command.*

- **Project and Contract Manager:** Coordinates and oversees production of Town Gazette.
**COVID-19 Functioning Role: Serves on COVID-19 Task Force.*

ORDINANCE NO. 17 - _____

AN ORDINANCE OF THE TOWN COMMISSION OF THE TOWN OF SURFSIDE, FLORIDA AMENDING ARTICLE VI. - “RULES OF PROCEDURE FOR TOWN MEETINGS”; PROVIDING FOR SEVERABILITY; PROVIDING FOR INCLUSION IN THE CODE; PROVIDING FOR CONFLICTS AND PROVIDING FOR AN EFFECTIVE DATE.

1 **WHEREAS**, Section 20 of the Town of Surfside Charter provides that the Town Commission
2 of the Town of Surfside shall fix its rules of procedure; and

3 **WHEREAS**, the Town Commission adopted rules of procedure which have been
4 incorporated into Article, VI, Chapter 2 of the Town Code of Ordinances; and

5 **WHEREAS**, the Town Commission desires to amend Article VI. – “Rules of Procedure for
6 Town Meetings;” and

7 **WHEREAS**, the amendments to the ordinance do not conflict with the provisions in Section
8 2-151 Personnel Appeals Board Section, 2-185 Pension Board, Section 70-124 Resort Tax Board
9 or Sections 90-15, 90-16, 90-17, 90-18 of the Zoning Code for Planning and Zoning and Design
10 Review Board members; and

11 **WHEREAS**, the Town Commission held its first public reading on September 18, 2017 and
12 recommended approval of the proposed amendments to the Code of Ordinances having complied
13 with the notice requirements by the Florida Statutes; and

14
15 **WHEREAS**, the Town Commission has conducted a second duly noticed public hearing on
16 these regulations as required by law on October 10, 2017 and further finds the proposed change to
17 the Code necessary and in the best interest of the community.

18
19 **NOW, THEREFORE, BE IT ORDAINED BY THE TOWN COMMISSION OF THE**
20 **TOWN OF SURFSIDE, FLORIDA:**

21
22 **Section 1. Recitals.** The above Recitals are true and correct and are incorporated herein by
23 this reference:

24
25 **Section 2. Town Code Amended.** Article VI. – “Rules of Procedure for Town Meetings”
26 of the Surfside Town Code of Ordinances are hereby amended and shall read as follows¹:

27 **ARTICLE VI. - RULES OF PROCEDURE FOR TOWN MEETINGS**
28

¹Additions to the text are shown in underline. Deletions are shown in ~~strikethrough~~. Additions made after first reading are shown in double underline. Deletions made after first reading are shown in ~~double-strikethrough~~.

29 Sec. 2-201. - Rules of procedure for the town commission and town boards and committees.

30 *Rule 2.01 Governing rules; amendment.* Except as may be provided in the Charter, the
31 Town of Surfside Code, Florida laws or by these rules as set forth in this Article^{ordinance},
32 questions of order, the methods of organization and the conduct of business of the town
33 commission and town boards and committees and to the extent there is no conflict, the town
34 commission, and town boards and committees shall be governed by Robert's Rules of Order
35 ~~Mason's Manual of Legislative Procedure (2010 Edition)~~. Once enacted, and except as already
36 amended by the provisions contained herein, these rules may be amended by ~~two-thirds~~ majority
37 vote of the entire town commission.

38 Sec. 2-202. - Officers.

39 *Rule 3.01 Presiding officer.* The ~~mayor~~Mayor shall preside at all meetings of the town
40 commission at which he or she is present. In the absence of the ~~mayor~~Mayor, the vice
41 ~~mayor~~Mayor shall act as ~~mayor~~Mayor. In the absence of both the ~~mayor~~Mayor and vice
42 ~~mayor~~Mayor, the town commission shall select one of its members as a temporary presiding
43 officer. The presiding officer shall preserve strict order and decorum at all meetings of the
44 commission. A majority vote of the members present shall govern and conclusively determine all
45 questions of order not otherwise covered. The presiding officer has the power, among other
46 things, to recognize a speaker, secure and retain the floor for the speaker and keep order during
47 the time the floor is taken subject to Robert's ~~Mason's~~ Rules and to the rules contained in this
48 article.

49 *Rule 3.02 Clerk.* The town clerk shall act as clerk of the commission. The clerk of the
50 commission shall call the roll, prepare the minutes and shall be custodian of the records and shall
51 certify all ordinances and resolutions adopted by the commission, and perform such other duties
52 as required by the Town Charter.

53 *Rule 3.03 Town attorney.* The town attorney, or such member of the office of the town
54 attorney as may be designated, shall be available to the commission at all meetings: the town
55 attorney shall act as parliamentarian, and shall advise and assist the presiding officer in matters
56 of parliamentary law.

57 *Rule 3.04 Sergeant-at-arms.* The town police chief, or such other town official or employee
58 as the chief may designate, shall be the sergeant-at-arms of the town commission meeting, at the
59 request of the presiding officer or the town manager. The sergeant-at-arms shall carry out all
60 orders and instructions given by the presiding officer or the town manager for the purpose of
61 maintaining order and decorum at the meetings.

62 Sec. 2-203. - Meetings.

63 *Rule 4.01 Regular Meetings.*

64 (a) The commission shall hold regular meetings in accordance with its Charter or, if the Charter
65 provision is amended, in accordance with an ordinance duly adopted by the commission, as
66 may be amended from time to time.

- 67 (1) All regular and zoning meetings shall be held irrespective of whether or not any particular
68 commission member (including the ~~Mayor~~Mayor) may be able to attend unless otherwise
69 agreed by a majority of the commission. Such meetings shall be held in the commission
70 chambers at 9293 Harding Avenue, Surfside, Florida 33154, or such location as may be
71 approved by a majority of the commission members present and shall be open to the public
72 and all news media.
- 73 (2) Regular meetings may be otherwise postponed or canceled by resolution or motion
74 adopted at a regular meeting by a majority of the commission members present.
- 75 (3) No meeting shall continue beyond 11:00 p.m. unless there is an emergency, which is
76 presented to the Commission, which is then followed with by a vote of the majority of the
77 members of the commission present, the commission agrees to extend the meeting beyond
78 this time.
- 79 (4) Workshops may be scheduled at the request of the Mayor, town manager, the town
80 attorney or a majority of the commission at any time, provided appropriate notice is given.
- 81 (b) Zoning matters shall be scheduled as part of regular town commission meetings unless
82 otherwise decided by the commission.
- 83 (c) The second reading (public hearing) of the annual budget ordinance or resolution shall be
84 considered at a meeting at which the said budget ordinance or resolution and the levy of the
85 millage are the only items on the agenda.

86 *Rule 4.02 Special meetings; emergency meetings.*

- 87 (1a) Special meetings. A special meeting of the commission may be called by the Mayor, a
88 majority of the members of the ~~Mayor~~, town commission or the town manager. The clerk
89 shall forthwith serve either verbal or written notice upon each member of the commission
90 stating the date, hour and place of the meeting and the purpose for which such meeting is
91 called; and no other business shall be transacted at that meeting, other than that described
92 in the aforementioned notice. At least twenty-four (24) ~~hours notice~~ hour's' notice must
93 elapse between the time the clerk receives notice in writing and the time the meeting is to
94 be held.
- 95 (2b) Emergency meetings. An emergency meeting of the town commission may be called by
96 the Mayor, ~~mayor~~Mayor in accordance with prescriptions of the town charter whenever
97 in his or her; opinion an emergency exists that requires immediate action by the
98 commission. Whenever such emergency meeting is called, the ~~M~~mayorMayor shall
99 notify the clerk who shall forthwith serve either verbal or written notice upon each
100 member of the commission, stating the date, hour and place of the meeting and the
101 purpose for which it is called, and no other business shall be transacted at that meeting,
102 other than that described in the aforementioned notice. At least 24 hours shall elapse
103 between the time the clerk receives notice of the meeting and the time the meeting is to
104 be held.
- 105 (3e) If after reasonable diligence, it is impossible to give notice to each commissioner, such
106 failure shall not affect the legality of the meeting if a quorum is present. The minutes of
107 each special or emergency meeting shall show the manner and method by which notice of

108 such special or emergency meeting was given to each member of the commission, or shall
109 show a waiver of notice. All special or emergency meetings shall be open to the public
110 and shall be held and conducted in the Commission Chambers, Town Hall, 9293 Harding
111 Avenue, Surfside, Florida 33154, or other suitable location within the Town of Surfside,
112 Florida. Minutes thereof shall be kept by the town clerk.

113 (4d) No special or emergency meeting shall be held unless notice thereof is given in compliance
114 with the provisions of this rule, or notice thereof is waived by a majority of the entire
115 membership of the commission and in accordance with the town charter.

116 *Rule 4.03 Electronic files presented at public meetings.* Electronic files to be presented at
117 public meetings in the Town of Surfside must be provided to the town clerk by noon on the
118 business day prior to the scheduled meeting.

119 Sec. 2-204. – Boards, cCommittees, sub-committees and ad hoc committees.

120 *Rule 5.01 Boards, ccontinuing committees, sub-committees and ad hoc committees.* There
121 may be continuing committees, sub-committees and ad hoc committees of the town commission
122 created by resolution as the town commission deems necessary to conduct the business of the
123 town appropriately and in accordance with the town charter. Such committees and all Town
124 Boards to the extent these provisions do not conflict with other governing procedures or
125 requirements specific to a particular Board, shall be governed by these rules of procedure and
126 shall be subject to the Florida sunshine and public records laws. Each member of the town
127 commission shall appoint one (1) member to each committee. All appointments are at the will of
128 the appointing member of the town commission and may be removed at any time by the
129 appointing member of the town commission. Members of committees shall be appointed to serve
130 until the expiration of the committee or to the end of the appointing member of the town
131 commission's term.

132 (a+) *Continuing committees and sub-committee committees.* Continuing committees and sub-
133 committees shall exist until abolished by the town commission or shall have a sunset provision.

134 (b2) *Ad hoc committees.* The expiration date for each ad hoc committee shall be designated at the
135 time of formation, or the ad hoc committee shall expire when the ad hoc committee reports to
136 the commission that its designated goal or goals have been accomplished.

137 (c3) All continuing committees, sub-committees and ad hoc committees shall abide by the
138 following procedures:

139 (1)a- *Mission statement.* A mission statement shall be developed by the town commission.

140 (2)b- *Public meetings.* All meetings and business of any committee, sub-committee or ad
141 hoc committee shall comply with the Florida Statutes including that all committee
142 meetings shall be open to the public at all times, noticed, and minutes of the meetings shall
143 be taken and retained in the office of the town clerk. All committee members shall be
144 subject to the State of Florida, Miami-Dade County and Town of Surfside Conflict of
145 Interest and Code of Ethics Ordinance.

146 (3)e- *Agenda.* The committee chairperson shall prepare the agenda for the committee
147 meeting with the assistance of the committee staff liaison. ~~In the chairperson's absence,~~

148 ~~the vice chairperson shall prepare the agenda.~~ Any committee member may propose
149 additional agenda items at any time. Items proposed after the agenda is distributed may
150 only be heard under "New Business" and upon an affirmative vote of the majority of the
151 committee. Each agenda shall also include a section for public comment.

152 ~~(4)d.~~ *Public appearances and requests.* Any person may appear before any committee
153 during the public comment portion of the meeting.

154 ~~(5)e.~~ *Quorum.* A majority of the appointed members of the committee shall constitute a
155 quorum. ~~shall be 50 percent plus one of the committee members.~~ Provided there is a
156 quorum, a majority of those present and voting shall be required to adopt any motion or
157 take any action.

158 ~~(6)~~ *Failure to obtain a quorum.*

159 a. If, 48 hours prior to a regular meeting, the clerk has not received confirmation of
160 attendance from a sufficient number of committee members to constitute a quorum,
161 the meeting shall be canceled for lack of a quorum.

162 b. Should no quorum attend any meeting within 15 minutes after the hour appointed for
163 the meeting, the presiding member or the town clerk may adjourn the meeting. The
164 names of the members present at such meeting shall be recorded in the minutes.

165 ~~(7)f.~~ *Voting.* Each committee member shall be entitled to one vote. The committee shall act as
166 a body in making its decisions. No committee member present at a meeting may abstain
167 from voting unless the committee member possesses a conflict of interest, as provided in
168 either the Florida Statutes or the Miami-Dade County Code of Ethics and submits the
169 appropriate form to the town clerk.

170 ~~(8)g.~~ *Attendance.* In the event that a committee member fails to attend three regularly
171 scheduled meetings in any one calendar year, the committee member may be removed
172 from the committee and the town commission will be notified of the vacancy.

173 ~~(9)h.~~ *Appointments, vacancies and resignations.* Each person appointed to a committee,
174 sub-committee or ad hoc committee shall be appointed by the town commission in the
175 following manner:

176 ~~a1.~~ The ~~mayer~~ Mayor and each member of the town commission shall appoint one
177 member to each committee.

178 ~~b2.~~ Should any appointee resign or be removed during the term of the committee, sub-
179 committee or ad hoc committee, the appointing commissioner may select another
180 appointee in accordance with the procedure outlined as follows:

181 Upon notification of the vacancy of an at-large member, the town clerk shall notify
182 the town commission, or in the case of an individual appointment, the town
183 commissioner responsible for the appointment with a copy to the remainder of the
184 town commission, in writing. ~~The town commission shall establish a deadline for the~~
185 ~~submission of letters of interest to serve on the committee at a commission meeting.~~

186 ~~1.(i)~~ Any person who wishes to serve on a committee and who meets the qualifications
187 of office as set forth in this code and in the resolution creating or re-authorizing

188 the committee, shall submit his or her name and committee application available
189 from the town clerk or on the town website ~~together with a letter of interest~~ to the
190 town clerk ~~by the deadline established by the town commission~~. Thereafter, the
191 town clerk shall provide the appointing town commissioner or the entire town
192 commission, as applicable, with the names and submitted material(s) ~~letters of~~
193 interest.

194 ~~2.~~(ii) Nominations and appointments to fill the vacancy shall be made at a town
195 commission meeting. Appointments to fill a mid-term vacancy shall only be
196 made for the remainder of the term of the committee member being replaced.

197 (10)i- *Reappointment.* Committee, sub-committee or ad hoc committee members shall be
198 eligible for reappointment and shall hold office until their successors have been duly
199 appointed and qualified.

200 (11)j- *Residency requirement.* Committee, sub-committee or ad hoc committee members
201 shall be registered qualified electors of Miami-Dade County, Florida, whose legal
202 residence is in the Town of Surfside.

203 (12)k- *Compensation.* All committee, sub-committee or ad hoc committee members shall
204 serve without compensation and shall not otherwise obtain direct or indirect financial gain
205 from their service on a committee.

206 (13)l- *Oath requirement.* All committee, sub-committee or ad hoc committee members
207 shall be required to subscribe to an oath or affirmation to be administered by and filed with
208 the town clerk, swearing to support, protect and defend the Constitution and laws of the
209 United States and of the State of Florida, the Charter and all ordinances of the Town of
210 Surfside and Miami-Dade County, and in all respects to faithfully discharge their duties.

211 (14)m- *Financial disclosure requirement/standards of conduct.* If required by law,
212 committee members shall file appropriate annual financial disclosure forms. All
213 committee members shall be subject to the standards of conduct for public officers and
214 employees set by federal, state, county or other applicable ethics or conflicts of interest
215 laws.

216 (15)n- *Officers and elections.* Except as provided otherwise in the resolution creating or re-
217 authorizing a committee, each committee shall elect a chairperson, and vice-chairperson
218 ~~and secretary~~ at the first committee meeting.

219 (16)o- *Records.* Minutes of all committee meetings shall be prepared by the town
220 administration and shall be available for public inspection. The minutes shall be forwarded
221 to each committee member for review and shall be approved by the committee at a public
222 meeting. Once approved, the meeting minutes shall be forwarded to the town clerk for
223 filing. ~~Attendance and absences must be recorded and submitted to the town clerk along~~
224 ~~with the minutes.~~ The ~~chair~~secretary of a committee, sub-committee or ad hoc committee,
225 working with the staff liaison, shall prepare a final report summarizing the committee's
226 activities, accomplishments, challenges and recommendations during the term. Such
227 report shall be presented for review and approval by the committee no later than the last
228 meeting of the term, and to be submitted to the town clerk for transmittal to the town

229 commission which shall be presented at the first a regular town commission meeting after
230 the election.

231

232 *Rule 5.02 Town commission liaison; appointment and definition.*

233 (a1) *Appointment:* The ~~mayer~~Mayor shall designate and appoint one member of the town
234 commission as the liaison to each board, committee and subcommittee of the town commission.

235 (b2) *Definition:* The town commission liaison is defined as a nonvoting member of a board,
236 committee or sub-committee who communicates the activities of the board, committee or
237 subcommittee to the town commission. The liaison's role is limited to responding to questions
238 posed by members of the board, committee or subcommittee to which the liaison serves. All
239 remarks from the liaison shall be addressed to the chair who serves as the presiding officer.

240 Sec. 2-205. - Conduct of meetings; agenda.

241 *Rule 6.01 Call to order.* Promptly at the hour set for each meeting, the ~~mayer~~Mayor and the
242 members of the town commission, the town attorney, the town manager and the town clerk shall
243 take their regular stations in the commission chambers. The presiding officer shall take the chair
244 and shall call the town commission to order immediately. In the absence of the presiding officer,
245 the town clerk shall then determine whether a quorum is present and in that event shall call for
246 the election of a temporary presiding officer. Upon the arrival of the presiding officer, the
247 temporary presiding officer shall relinquish the chair upon the conclusion of the business
248 immediately before the commission.

249 *Rule 6.02 Roll call.* The town clerk shall call the roll of the members, and the names of those
250 present shall be entered in the minutes. In the event the roll call reflects the absence of any
251 member on official town business that fact shall be noted in the minutes. Any town commissioner
252 who intends to be absent from town commission meeting shall notify the town clerk of the
253 intended absence as soon as convenient.

254 *Rule 6.03 Participation by physically absent member of the town commission; town board*
255 *or committee. ~~shall be permitted, but a town board or committee. -shall no bet permitted.~~ A*
256 *member of the town commission shall be permitted to participate and/or vote telephonically, by*
257 *virtual video or other electric means, provided that a physical quorum of the town commission is*
258 *present. A ~~but, a~~ town board or committee shall not be ~~is not~~ permitted to participate and/or vote*
259 *telephonically, by virtual video -and/or by interactive video.*

260 *Rule 6.04 Quorum.* A majority of the members of the town commission then in office shall
261 constitute a quorum. No ordinance, resolution or motion shall be adopted by the town commission
262 without the affirmative vote of the majority of all the members present.

263 *Rule 6.05 Failure to attain a quorum.* Should no quorum attend within 15 minutes after the
264 hour appointed for the meeting of the commission, the presiding officer or the town clerk may
265 adjourn the meeting. The names of the members present ~~and their action~~ at such meeting shall be
266 recorded in the minutes by the town clerk.

267 Rule 6.06 Agenda.

268 (a) *Order of business.* There shall be an official agenda for every meeting of the commission which
269 shall determine the order of business conducted at the meeting.

270 (1) The order of business shall be as follows:

271 ~~(a1)~~ order of business

272 a. call to order,

273 b. roll call of members,

274 c. pledge of allegiance,

275 d. agenda/order of business (additions/deletions),

276 e. special presentations,

277 (b) public comment on agenda items

278 ~~(b2)~~ quasi-judicial hearings

279 ~~(c3)~~ consent agenda at the pleasure of the commission, approval of minutes, town
280 manager, town attorney reports

281 ~~(d4)~~ ordinances,

282 ~~(e5)~~ resolutions

283 ~~(f6)~~ good and welfare shall be heard at a time certain at 8:15 p.m.

284 ~~(g7)~~ unfinished business and new business

285 ~~(h8)~~ ~~mayor~~ Mayor, town commission and staff communications.

286 ~~(24)~~ Items shall be considered in the order in which they are placed on the agenda unless a
287 majority of the commissioners determines to deviate from the printed agenda.

288 ~~(3)~~ ~~The public may comment- comment on all -agenda items portion of the meeting. -shall be not be~~
289 ~~restricted to discussion on agenda items which are not scheduled for public hearing. Each speaker~~
290 ~~shall be given no more than three minutes to address the agenda speak and shall try to end on~~
291 ~~time as a courtesy to the residents and other participants wishing to also speak on the item. ,~~
292 ~~unless by vote of a majority of the members of the commission present, it is agreed to extend the~~
293 ~~time frames.~~

294 ~~(32)~~ The good and welfare portion of the agenda set for 8:15 p.m. ~~-shall provide for public~~
295 ~~comment on any items related to Town business or any matter within the scope of the~~
296 ~~jurisdiction of the town commission, whether or not included on the agenda for the~~
297 ~~meeting. shall be restricted to discussion on subjects not already specifically scheduled~~
298 ~~on the agenda. In no event shall this portion of the agenda be allotted more than 45 minutes~~
299 ~~with each speaker to be given no more than three minutes, unless by vote of a majority of~~
300 ~~the members of the commission present, it is agreed to extend the time frames. Likewise,~~
301 ~~members of the town commission shall be restricted to speaking three minutes each unless~~
302 ~~an extension is granted in the same manner as set forth in the prior sentence. The rules of~~

303 section 2-207(e) as set forth hereinbelow shall be observed during this portion of the
304 agenda.

305 (4~~3~~) The town commission shall not take action upon any matter, proposal, or item of business
306 which is not listed upon the official agenda, unless it is approved at the meeting by a
307 majority of the entire commission, which shall have first consented to the matter for
308 consideration. No ordinance, resolution or other matter listed on the agenda for public
309 hearing, or the vote thereon, may be deferred until a later time unless a majority of the
310 entire town commission shall vote in favor of such deferral.

311 (b) ~~Authority to p~~Placing items on agenda.

312 ~~(12) Ordinances, Resolutions and O~~Ordinances may be prepared and scheduled on the agenda
313 at the direction of the town commission, a town commissioner with the support of the
314 majority of the commissioners present at a town commission meeting, or by Mayor, the
315 town manager, town attorney or town clerk.

316 ~~(21) All other matters.~~ Matters, other than ~~resolutions or~~ ordinances, may be placed on the
317 agenda by any member of the town commission, the town manager, the town attorney and
318 the town clerk. ~~Members of the town commission may, at a town commission meeting,~~
319 ~~direct the town manager or the town attorney to prepare an resolution or ordinance for~~
320 ~~placement on the agenda for the following agenda.~~

321 ~~(32)Deadline.~~ In no event may any town commissioner place an item on an agenda unless all
322 materials for the item are provided to the town clerk by 12:00 noon seven working days
323 prior to the meeting date unless approved by the Town Manager. Any complete item
324 provided after 12:00 noon seven working days prior to the meeting date shall be
325 distributed to the commission with a "7-day cover memo" and shall be added to the agenda
326 only if a majority of the commissioners present consent to the addition of the item to the
327 agenda.

328 (c) *Approval of minutes.* All minutes shall be summary in nature. A copy of such completed
329 minutes shall be placed on a regular agenda and may only be approved by a majority of the
330 members of the town commission, and upon such approval shall become the official minutes.

331 *Rule 6.07 Ordinances, resolutions, motions, contracts.*

332 (a) *Preparation and enactment of ordinances.* The town attorney shall prepare ordinances and
333 resolutions. Ordinances may be introduced, listed by title and shall be read by title only before
334 consideration by the town commission on first reading. At public hearing, each ordinance shall
335 be voted on individually by a call of the roll. Only resolutions and motions may be enacted by
336 voice vote calling for "ayes" or "no" on the question.

337 (b) *Approval by town attorney.* All ordinances, resolutions and contract documents, before
338 presentation to the town commission, shall have been reduced to writing and reviewed for form
339 and legality by the town attorney. Ordinances, resolutions and contract documents, in their
340 final form as approved by the Town Commission shall be ~~have been~~ approved as to form and
341 legality by the town attorney prior to execution.

342 (c) *Introduction and sponsorship.* Ordinances, resolutions and other matters and subjects requiring
343 action by the town commission may be introduced and sponsored by the ~~mayor~~Mayor or any
344 member of the town commission, ~~except that either the~~ The town manager, the town attorney or
345 town clerk may present ordinances, resolutions and other matters or subjects to the town
346 commission for consideration, and any commissioner may assume sponsorship thereof by
347 moving that such ordinance, resolution, matter or subject be adopted in accordance with law;
348 otherwise they shall not be considered.

349 (d) *Sunset.* There is no requirement for any ordinance to contain a sunset provision.

350 (e) *Zoning exception.* The provisions of this Rule 6.06 shall not be applicable to zoning resolutions
351 which shall be governed exclusively by the Zoning Code.

352 ~~(f) *No commission jurisdiction.* Prior to the commission's considering any resolution over which
353 the commission does not have substantive jurisdiction, including resolutions expressing the
354 commission's intent or opinion, a preliminary vote shall be taken to determine whether it is
355 appropriate for the commission to consider such resolution. Unless the commission, by a two-
356 thirds vote of the members present, agrees to consider the resolution, the resolution shall be
357 deemed to have failed. If the commission agrees to consider the resolution, the resolution shall
358 be heard after all other resolutions sponsored by commissioners have been addressed by the
359 commission. If the commission decides to discuss such resolution, the resolution shall require
360 a two-thirds affirmative vote of the commissioners present in order to be passed. The provisions
361 of this ordinance shall not apply to resolutions relating to state or federal legislative priorities.~~

362 *Rule 6.08 Statement of fiscal impact required for ordinances; exceptions.* Prior to the second
363 reading of any ordinance, the town manager shall prepare a written statement setting forth the
364 fiscal impact, if any, of the proposed ordinance. No ordinance shall be considered on second
365 reading if the statement of fiscal impact is not submitted with the ordinance as part of the agenda.
366 The provisions of this rule shall not apply to any emergency ordinance or any budget ordinance
367 or resolution.

368 *Rule 6.09 Limitation on agenda items.* No commissioner shall sponsor or cosponsor a total
369 of more than three ordinances for first reading and three resolutions at any commission meeting.
370 This provision shall not be applied to ordinances or resolutions which are intended to correct
371 scrivener's errors.

372 Sec. 2-206. - Public participation.

373 *Rule 7.01 Persons authorized on the dais.* No person, except town officers or their
374 representatives, shall be permitted on the dais unless authorized by the presiding officer or a
375 majority of the town commission.

376 *Rule 7.02. Citizens presentations; public hearings.*

377 (a) *Citizens' presentations.* Any citizen ~~may request may request shall be entitled shall be entitled~~
378 to be placed on the official agenda of a regular meeting of the town commission and be heard
379 concerning any matter within the scope of the jurisdiction of the town commission ~~outside of~~
380 Good and Welfare. Only members of the town commission and the town manager may place
381 a citizen on the official agenda.

382 (b) *Public hearings.* Any citizen shall be entitled to speak on any matter appearing on the official
383 agenda under the section "public hearings."

384 (c) *Public discussion on agenda items.* ~~No citizen shall be entitled~~Citizens shall be permitted to
385 address the town commission on any matter listed on or added to the official agenda which is
386 not scheduled for public hearing, discussion or debate. ~~except during Public Comment on~~
387 ~~Agenda Items unless the item is opened for public comment and the speaker recognized by the~~
388 ~~Chair~~Good and Welfare. When the town commission considers an agenda item that is open for
389 public hearing, discussion or debate that is not a public hearing and on which the public
390 comment is either unanimously in favor or unanimously against the item's passage, input from
391 members of the public shall be limited to no more than three minutes on any given item, unless
392 an extension is granted by a majority of the members of the town commission.

393 *Rule 7.03 Registration of speakers.*

394 (a) Registration of speakers ~~shall be required~~ shall be encouraged. The town clerk shall prepare
395 appropriate registration cards. The cards shall include a place for the speaker to provide his/her
396 name, address, lobbyist registration status which may be verified by the town clerk prior to
397 speaking, and the agenda item on which he or she is speaking ~~if registration is required on a~~
398 ~~particular agenda item.~~

399 (b) For any single agenda item, and except for zoning, no more than one-half hour per side shall
400 be allocated to speakers from the public. The presiding officer shall limit the time of each
401 individual speaker in order to insure compliance with this rule.

402 *Rule 7.04 Addressing commission, manner, time.* Each person, other than ~~salaried~~ members
403 of the town staff, who addresses the town commission shall step up to a podium and shall give
404 the following information in an audible tone of voice for the minutes:

405 (a) Name;

406 (b) Address;

407 (c) Whether the person speaks on his or her own behalf, a group of persons, or a third party; if the
408 person represents an organization, the person shall also indicate the number of members in the
409 organization, the annual dues paid by the members, the date of the most recent meeting of the
410 organization's board or governing council, and whether the view expressed by the speaker
411 represents an established policy of the organization approved by the board or governing
412 council, if requested; if the person is speaking on behalf of a group, s/he shall be required to
413 register as a lobbyist if required by that ordinance and shall state for the record: (i)
414 Compensation, if any, (ii) whether the person or any immediate family member has a personal
415 financial interest in the pending matter, other than as set forth in (i) if requested.

416 Unless further time is granted by the town commission and with the sole exception of zoning items
417 which shall not have a prescribed time limit unless imposed by the chair in accordance with the
418 advice of the town attorney, the statement shall be limited to the times prescribed herein. All
419 remarks shall be addressed to the town commission as a body and not to any member thereof. No
420 person, other than the ~~mayor~~Mayor, members of the town commission and the person having the
421 floor shall be permitted to enter into any discussion, either directly or through a member of the

422 commission, without the permission of the presiding officer. No question shall be asked of any
423 member of the town commission except through the presiding officer.

424 *Rule 7.05 Decorum.* Any person making ~~impertinent or~~ slanderous remarks ~~or who becomes~~
425 ~~boisterous~~ while addressing the town commission shall be warned. If after the warning, the
426 behavior continues, said person shall be barred from further appearance before the town
427 commission by the presiding officer for the duration of the meeting, unless permission to continue
428 or again address the town commission is granted by the majority vote of the town commission
429 members present. ~~No clapping, applauding, h~~Heckling or verbal outbursts in support or
430 opposition to a speaker or his or her remarks shall not be permitted. ~~Signs or placards may be~~
431 ~~disallowed in the town commission chambers by the presiding officer. Persons exiting the town~~
432 ~~commission chambers shall do so quietly.~~

433 Sec. 2-207. - Rules of debate.

434 *Rule 8.01 Rules of debate.*

435 (a) *Questions under consideration.* When a motion is presented and seconded, it is under
436 consideration and no other motion shall be received thereafter, except to adjourn, to lay on the
437 table, to postpone, or to amend until the question is decided. These motions shall have
438 preference in the order in which they are mentioned. A motion to adjourn and a motion to lay
439 on the table shall be decided without debate. Final action upon a pending motion may be
440 deferred until a date certain by a majority of the members present.

441 (b) *As to the presiding officer.* The ~~mayor~~Mayor, as presiding officer, may vote on but shall not
442 move or second an item of debate. The presiding officer, however, upon relinquishing the chair,
443 may move or second an item, ~~vote~~, subject only to such limitations as are by these rules
444 imposed upon all members.

445 (c) *Getting the floor, improper references to be avoided.* Every member desiring to speak for any
446 purpose shall address the presiding officer, ~~and~~ upon recognition, ~~shall be confined to the~~
447 ~~question under debate avoiding all personalities and indecorous language.~~

448 (d) *Interruption; call to order; appeal a ruling of the chair.* A member once recognized shall not
449 be interrupted when speaking unless it is a call to order or as herein otherwise provided. If a
450 member be called to order, the member shall cease speaking until the question of order is
451 determined by the presiding officer, and if in order, the member shall be permitted to proceed.
452 Any member may appeal to the town commission from the decision of the presiding officer
453 upon a question of order when, without debate, the presiding officer shall submit to the town
454 commission the question, "Shall the decision of the chair be sustained?" and the town
455 commission shall decide by a majority vote.

456 (e) *Time limit for Consent agenda debate.* The presiding officer shall open for public comment on
457 any items on the consent agenda, prior to commission consideration of the consent agenda.
458 There shall be no dDebate on any motion pertaining to an item on the consent agenda, however,
459 any member of the town commission may pull an item from the consent agenda for
460 consideration shall be limited to three minutes. After three minutes of debate the item shall be
461 removed from the consent agenda, if any, and placed on the regular town commission agenda.

462 ~~The discussion by the town commission on any one item shall not exceed one half hour or~~
463 ~~unless an extension is granted by a majority of votes of the town commission.~~

464 (f) *Privilege of closing debate.* Any town commission member (including the presiding officer)
465 shall have the privilege of closing the debate by making a motion to that effect and provided it
466 is affirmed by vote of a majority of the town commission present.

467 (g) *Method of voting.* After the debate is closed, and/or the motion is restated if necessary, the
468 presiding officer shall call for a vote on the motion. Voting shall be by roll call or voice vote,
469 or paper ballot (at the decision of the majority of the commission in certain circumstances)
470 depending on whether the ballot is on an ordinance or resolution or motion. Ordinances require
471 a roll call vote by calling the names of the members of the town commission in rotating order,
472 provided that the ~~V~~ice-mayorMayor shall vote next to last and alphabetically by surname,
473 except that the names shall be rotated after each roll call vote, if requested, so that the
474 commissioner who voted first on a preceding roll call shall vote last upon the next subsequent
475 matter; provided, however, that the presiding officer, if a member of the town commission,
476 shall always cast the last vote.

477 The town clerk shall call the roll, tabulate the votes, and announce the results. The vote upon
478 any resolution, motion or other matter may be by voice vote as previously noted, provided that
479 the presiding officer or any commissioner may require a roll call to be taken upon any
480 resolution or motion.

481 (h) *Explanation of vote; conflicts of interest.* There shall be no discussion by any town
482 commissioner voting, and the town commissioner shall vote yes or no. Any town
483 commissioner, upon voting, may give a brief statement to explain his or her vote. A town
484 commissioner shall have the privilege of filing with the clerk a written explanation of his or
485 her vote. Any town commissioner with a conflict of interest on a particular matter shall refrain
486 from voting or otherwise participating in the proceedings related to that matter and must leave
487 the commission chambers until the consideration of that matter is concluded and file the proper
488 form with the town clerk.

489 (i) *Tie votes.* Whenever action cannot be taken because the vote of the town commissioners has
490 resulted in a tie, the status quo shall continue in effect and the proposed ordinance, resolution
491 or motion that produced the tie vote shall be removed from the agenda without prejudice to its
492 reintroduction on a de novo basis at a later time, ~~provided that in zoning and other quasi-~~
493 ~~judicial matters when action on a resolution results in a tie vote, such resolution matter shall~~
494 ~~be carried over to the next regularly scheduled meeting for the consideration of such quasi-~~
495 ~~judicial matters unless the town commission designates a different time for such~~
496 ~~reconsideration.~~

497 (j) *Vote change.* Any town commissioner may change his or her vote before the next item is called
498 for consideration, or before a recess or adjournment is called, whichever occurs first, but not
499 thereafter. In this case, the town clerk shall call back the vote and verify the outcome for the
500 presiding officer.

501 (k) *No motion or second.* If an agenda item fails to receive a motion or second, it shall be removed
502 from the agenda and shall be reintroduced only in accordance with the renewal provisions of
503 Rule 8.01(m).

504 (l) *Reconsideration.* An action of the town commission may be reconsidered only at the same
505 meeting at which the action was taken, or, if not, at the next meeting thereafter a motion to
506 reconsider may be made only by a town commissioner who voted on the prevailing side of the
507 question and must be concurred in by a majority of those present at the meeting. ~~A motion to~~
508 ~~reconsider shall not be considered unless at least the same number of town commissioners is~~
509 ~~present as participated in the original vote, or upon affirmative vote of two thirds of those~~
510 ~~commissioners present.~~ Adoption of a motion to reconsider shall rescind the action
511 reconsidered.

512 (m) *Renewal.* Once action is taken on a proposed ordinance or resolution neither the same matter
513 nor its repeal or rescission may be brought before the town commission again for a three-month
514 period following the said action unless application for renewal by three commissioners is first
515 submitted to the presiding officer. Should an ordinance or resolution be proposed that raises
516 the same previously resolved matter, or its repeal or rescission, in different or modified form
517 during the three-month period, the presiding officer may declare the proposal out of order.

518 (n) *Adjournment.* A motion to adjourn shall always be in order and decided without debate.

519 (o) *Suspension of the rules.* No rule of procedure adopted by the town commission shall be
520 suspended except by an affirmative vote of a majority two-thirds of the members of the town
521 commission present.

522 Sec. 2-208. - Additional ordinances prescribing town commission procedure.

523 ~~Rule 9.01 Representation of Town of Surfside. Whenever~~ The presiding officer town
524 ~~commission may, with the consent of the designee, designate a member(s) of the town~~
525 ~~commission to represent the town commission at such meetings, conferences or other occasions~~
526 ~~as deemed deems it necessary or desirable that by the town commission, shall be represented at~~
527 ~~meetings, conferences or other occasions involving other governmental entities, agencies,~~
528 ~~officials or groups, or non-governmental organizations, or departments, agencies or officials of~~
529 ~~the town government, the presiding officer may designate members of the town commission to~~
530 ~~represent the town commission at such meetings, conferences or other occasions, with the consent~~
531 ~~of the designee. A designation must be ratified by a majority of the members of the town~~
532 ~~commission then present may disapprove any such appointment.~~ Such representative(s) shall have
533 no power to act for or on behalf of the town commission, or to make any commitment or binding
534 obligation on behalf of the town commission or the town. Such representatives shall report to the
535 town commission with regard to such meeting, conference or other occasion.

536 *Rule 9.02 Noncompliance with procedural rules.* If a procedural rule pursuant to this Article
537 VI. — "Rules of Procedure for Town Meetings" is not complied with as a result of either mistake,
538 inadvertence or excusable neglect, as those terms are defined by law, by either the presiding
539 officer or the parliamentarian, then the validity of the underlying substantive ordinance,
540 resolution, motion or other action shall in no way be affected thereby, and the failure of
541 compliance with said procedural rule shall not be the basis for any person or party to challenge
542 any ordinance, resolution or other action.

543 Sec. 2-209. - Amendment to rules of procedure for town meetings.

544 Once adopted, changes to these rules may be made as changes to any other ordinance are
545 made by a majority vote and after two readings of the amendatory ordinance.

546 Secs. 2-210—2-225. - Reserved.

547 **Section 3. Severability.** If any section, sentence, clause or phrase of this ordinance is held
548 to be invalid or unconstitutional by any court of competent jurisdiction, then said holding shall in
549 no way affect the validity of the remaining portions of this ordinance.

550 **Section 4. Inclusion in the Code.** It is the intention of the Town Commission, and it is hereby
551 ordained that the provisions of this Ordinance shall become and made a part of the Town of Surfside
552 Code of Ordinances, that the sections of this Ordinance may be renumbered or re-lettered to
553 accomplish such intentions; and the word “Ordinance” may be changed to “Section” or other
554 appropriate word.

555
556 **Section 5. Conflicts.** Any and all Ordinances and Resolutions or parts of Ordinances or
557 Resolutions in conflict herewith are hereby repealed.

558
559 **Section 6. Effective Date.** This ordinance shall become effective upon adoption.

560
561 **PASSED and ADOPTED** on first reading this 18th day of September, 2017.

562
563 **PASSED and ADOPTED** on second reading this 10th day of October, 2017.

564
565
566 On Final Reading Moved by: _____

567
568 On Final Reading Second by: _____

569
570
571 **FINAL VOTE ON ADOPTION:**

572 Commissioner Daniel Gielchinsky _____

573 Commissioner Michael Karukin _____

574 Commissioner Tina Paul _____

575 Vice ~~Mayor~~ Mayor Barry Cohen _____

576 ~~Mayor~~ Mayor Daniel Dietch _____

577
578
579
580 _____
Daniel Dietch, ~~Mayor~~ Mayor

581
582 **ATTEST:**

583

584 _____
585 Sandra Novoa, MMC, Town Clerk

586 **APPROVED AS TO FORM AND LEGALITY FOR THE USE**
587 **AND BENEFIT OF THE TOWN OF SURFSIDE ONLY:**

589 _____
590 Weiss Serota Helfman Cole and Bierman, P.A.
591 Town Attorney
592



**Town of Surfside
Town Commission Meeting**

Town Hall Commission Chambers - 9293 Harding Ave, 2nd Floor
Surfside, FL 33154

DISCUSSION ITEM MEMORANDUM

Agenda #:

Date: May 12, 2020

From: Mayor Charles W. Burkett

Subject: Proposed Charter Amendment

On Tuesday, May 12, 2020, Surfside can take another bold step towards halting the over-development that was inflicted upon our Town by the former Mayor and most of his Commission allies over the last 10 years.

Your new Commission took the brave step at the last meeting to initiate the process to throw out the entire developer approved code now in use. It also voted to return Surfside to the 2004 code that was in place at the time 92% of residents voted to enshrine strict development restrictions into our Charter – Surfside’s version of the U.S.’s Constitution.

Over the last 10 years, starting in 2010, after I lost that election, Mr. Dietch and his allies went to work systematically changing the zoning laws, which allow builders free reign in the Collins / Harding district and elsewhere in our Town.

They even went so far as to gut our 2004 Charter amendment – the one designed to protect against the types of changes in the zoning code that Mr. Deitch and his allies would make in the zoning code over the last 10 years.

The next part of the story will get a little into the weeds, however it will show HOW, Mr. Dietch and his over-development allies, seized the power back from the residents to control development in Surfside by CHANGING the Charter.

In my opinion, what you’re going to read now is really the most shocking part of the entire scheme.

In a breath-takingly deceptive and dishonest move, Mr. Dietch and his over-development allies, put forward a ballot question titled “RESTRICTION ON DEVELOPMENT”.

Not only were the contents of the proposed ballot question NOT restrictive, they catastrophically eviscerated the protections that had been written into the document.

Residents were understandably completely hoodwinked by the flowery language in the question that appeared on the ballot.

For instance, ask yourself these questions after reading the ballot question (attached) over a few times:

- a) What part of the question/statement contains restrictions? Answer: none.
- b) What is being reinforced? Answer: nothing.
- c) What is being clarified? Answer: nothing, however there's a whole lot being changed.

If you're wondering - like I was, what any of the ballot language really means, you'd have to look to the next (2nd attachment) which was the actual 'before and after' language in our Charter.

The words with lines under them are additions by Dietch and Company, and the words with lines through them, conversely were removed by Dietch and Company.

You can now see that NONE of the changes were "reinforcements" or "clarifications."

The changes were simply – changes - put in place to give developers the zoning code they needed to begin to turn Surfside into Sunny Isles or Miami Beach.

For instance:

The term "units per acre" replaced the term "floor areas."
"Maximum allowable floor area ratios" were stricken.
"Building heights" were redefined and,
Language pointing to the amendment being approved by Surfside voters was stripped out.

Does any of the foregoing sound like MORE "restrictions on development", the title of the ballot question? It is not!

Or does it sound to you, like it sounds to me? – A fraud perpetrated on the voters of Surfside, grossly misleading them with a deceptive ballot question, so elected officials could accommodate their developer friends by undoing and rewriting our protective zoning code.

Thursday, we have a chance to begin to unwind all of the unsavory and manipulative actions that were taken by the former Mayor and his over-development allies and I hope you'll join us to make it happen.

I want to address those who will say, let's just fix the current code and not go back to the old code by saying, it's not possible.

The reason the “new” zoning code was voted in was because it was newly written from start to finish, top to bottom – and for a very specific reason which we all are now seeing around us.

In a nutshell, the old code allowed small buildings on small lots and big ones on big lots. It regulated uses in our small Town to areas that supported those uses. It limited heights, size & many other important metrics.

The Dietch and his over-development allies zoning code now in place, initially put forward in 2010, has allowed developers to build bigger, higher and denser and is now so riddled with goodies, added by Mr. Dietch and his over-development allies over the last 10 years, that it needs to be thrown out, just as our old code was.

Yes, our old code may need some updates and tweaks before it’s perfect for 2020, and I’m very sure our new Commission is committed to supporting each one of those, but the point is, it’s better to fix a code that was written and put into place by those who cared for and wanted to protect residents from over development, rather than to try to fix an entire code that was sanctioned and put into place by those whose objective it was to turn our Town into Sunny Isles or Miami Beach!

See you Tuesday, May 12th at 7pm.



MEMORANDUM

To: Guillermo Olmedillo, Town Manager

From: Alan P. Graham, Code Compliance Director

Date: April 24, 2020

Subject: April 28, 2020 Special Town Commission Meeting
Discussion Item W, Regulation of Short-Term Rentals

Town Code Sections 90-41.1 provides the regulations for short-term rentals. The current code requires property owners to register with the Town all seasonal, short-term guests and to pay an appropriate registration fee and resort tax (4%).

The Code also limits a property owner to having three (3) short-term rentals over a twelve-month time period.

When a Code Compliance Officer becomes aware of a property that is rented on a short-term basis but did not register or pay the required fees, then the Officer sends out an invoice to the property owner for the monetary amount due. If the property owner does not remit to the Town the amount due, then Officer issues to the property owner a Civil Violation Ticket that carries a civil fine.

If the Town Commission wants to change any portion of this particular Town Code, then we would need to bring an Amended Ordinance before the Town Commission.

If you have any questions, then please contact me at (305) 861-4863 ext. 230.

cc: Lillian Arango, Town Attorney
Jason D. Greene, Finance Director
Sandra Novoa, Town Clerk



February 17, 2017

Town of Surfside
3293 Harding Ave
Surfside, FL 33154

Tel: (305) 777-2190

Attn: Randy Stokes
Public Works Director

Star Cleaning USA, Inc sweeping rate for the Town of Surfside will increase to \$33.40 per mile, effective from March 1st, 2017. The scope of service includes mechanical sweeping of the 25 miles of the Town of Surfside with a frequency of two times a month.

Note: All payment must be received within thirty (30) days after the invoice date.

* No taxes will be applied to this service.

Cancellation notice must be received 30 days in advance.

Respectfully,

Approved by:

Michael Gonzalez
Operations Manager
Star Cleaning U.S.A, Inc.

Randy Stokes

**BID BLANK
STATE JOB**

Let by: District 1 - Bartow

Star Cleaning USA, Inc.

(Void if used by any bidder other than one this Form issued to)

FINANCIAL PROJECT NO(S): 429423-1-72-01

ROAD(S) NO(S): On the primary

This project is let under the authority of Chapter 337, F.S.

CONTRACT NO.: E1K83-R0

CONTRACT CALENDAR DAYS: 365

DATE BIDS DUE: January 19, 2012

TOTAL AMOUNT:

DATE OF AWARD: February 13, 2012

\$ 20,607.50

DATE OF CONTRACT
EXECUTION: March 7, 2012

8.60 % DBE Availability



PROPOSAL

To Accompany
THE STANDARD SPECIFICATIONS AS AMENDED BY THE SPECIFICATIONS PACKAGE AND
ANY SUPPLEMENTAL SPECIFICATIONS PACKAGES, AND THE PLANS.

FOR ABOVE PROJECT(S)

The Improvements under this Contract consist of Mechanical Sweeping of Bridges, Curbs and Gutters

in Hardee, Desoto, Manatee, & Sarasota County(ies)

NOTE: Attach your Proposal Guaranty to this bid blank. All Extensions must be carried out. Any changes made in unit bid prices must be initialed by bidder.

P O S T I N G N O T I C E

UNLESS OTHERWISE NOTIFIED BY CERTIFIED MAIL, EXPRESS DELIVERY, HAND DELIVERY, FAX OR EMAIL RETURN RECEIPT, THE SUMMARY OF BIDS WILL BE POSTED AT THE DISTRICT CONTRACTS ADMINISTRATION WEB SITE <http://www.dot.state.fl.us/contractsadministrationdistrict1/>, AND SELECT LETTING DATE FROM THE DISTRICT 1 LETTINGS MENU, ON **FEBRUARY 7, 2012** OR IN THE ALTERNATIVE **FEBRUARY 14, 2012**. ADDITIONALLY A HARD COPY WILL BE POSTED ON THE FIRST FLOOR LOBBY OF THE DISTRICT ONE HEADQUARTERS BUILDING, FLORIDA DEPARTMENT OF TRANSPORTATION DISTRICT OFFICE COMPLEX, 801 NORTH BROADWAY AVENUE, BARTOW, FLORIDA 33830, AND WILL REMAIN POSTED FOR A PERIOD OF SEVENTY-TWO (72) HOURS. BY CALLING (863) 519-2559, DURING EACH POSTING PERIOD, INFORMATION CONCERNING THE POSTED PROJECTS CAN BE OBTAINED. THE POSTING PROVIDES NOTICE OF THE DEPARTMENT'S INTENT TO AWARD A CONTRACT OR REJECT ALL BIDS. THE DEPARTMENT'S NOTICE OF INTENT REGARDING A PROJECT WILL BE POSTED ON ONLY ONE OF THE ALTERNATE POSTING DATES. BIDDERS ARE SOLELY RESPONSIBLE FOR TIMELY MONITORING OR OTHERWISE VERIFYING ON WHICH OF THE SPECIFIED ALTERNATE POSTING DATES THE POSTING OF AWARD OR REJECTION OF ALL BIDS ACTUALLY OCCURS.

ANY PERSON ADVERSELY AFFECTED BY THE DEPARTMENT'S INTENDED DECISION TO AWARD A CONTRACT OR TO REJECT ALL BIDS SHALL FILE WITH THE CLERK OF AGENCY PROCEEDINGS, FLORIDA DEPARTMENT OF TRANSPORTATION, 605 SUWANNEE STREET, ROOM 562, TALLAHASSEE, FLORIDA 32399-0458, A NOTICE OF PROTEST, AND BOND WITHIN 72 HOURS OF POSTING OF THE SUMMARY OF BIDS. IF NOTICE OF INTENDED DECISION IS GIVEN BY CERTIFIED MAIL OR EXPRESS DELIVERY, THE ADVERSELY AFFECTED PERSON MUST FILE THE NOTICE OF PROTEST AND BOND WITHIN 72 HOURS AFTER RECEIPT OF THE NOTICE OF INTENT. A FORMAL WRITTEN PROTEST MUST BE FILED WITHIN TEN DAYS AFTER FILING THE NOTICE OF PROTEST. THE FORMAL WRITTEN PROTEST SHALL STATE WITH PARTICULARITY THE FACTS AND LAW UPON WHICH THE PROTEST IS BASED. IN ACCORDANCE WITH SECTION 120.57(3), FLORIDA STATUTES, FAILURE TO FILE A PROTEST WITHIN THE TIME PRESCRIBED IN SECTION 120.57(3), FLORIDA STATUTES, SHALL CONSTITUTE A WAIVER OF PROCEEDINGS UNDER CHAPTER 120, FLORIDA STATUTES.

IF THE POSTING DATES ARE REVISED, ALL BIDDERS FOR THE SUBJECT PROJECT WILL BE NOTIFIED OF THE DEPARTMENT'S INTENDED DECISION. BIDDERS MUST ACKNOWLEDGE RECEIPT OF THE NOTICE OF THE REVISED DATE.

**BID SOLICITATION NOTICE - District 1
FLORIDA DEPARTMENT OF TRANSPORTATION
CONSTRUCTION AND MAINTENANCE PROGRAMS**

Bartow, Florida
December 20, 2011
Advertisement No. 1

Bids for construction projects listed in this Bid Solicitation Notice with a budget of \$5 million or more must be submitted using Bid Express only. No other means of submission of bids will be accepted. Please visit the Contracts Administration Website at: <http://www.dot.state.fl.us/cc-admin> for more information on Bid Express.

Unless otherwise instructed, bids for construction projects with a budget of less than \$5 million and all maintenance projects listed in this Bid Solicitation Notice can be submitted using Bid Express or can be submitted at any of the following Florida Department of Transportation location(s) until 2:00 PM Local Time on **Thursday, January 19, 2012**. To obtain a Digital ID please contact Bid Express at <http://www.bidx.com>. Allow up to 6 days to complete the Digital ID registration.

Location	Address	Room Number
District 1	801 N. Broadway Bartow, Florida 33830	Procurement Services Conference Room

The sealed bids received in the above referenced location(s) will be publicly opened and the Bid totals for each bid submitted will be read aloud at 2:30 PM **January 19, 2012** in the Procurement Services Conference Room, Bartow, Florida. Anyone needing special accommodations under the Americans with Disabilities Act of 1990 should send an e-mail to: contracts.admin@dot.state.fl.us or call telephone number (863) 519-2559. Special accommodation requests under the Americans with Disabilities Act should be made at least seven days prior to the public meeting. If the budget amount is greater than \$250,000.00 on construction projects, the contractor must be prequalified as required by Florida Statute 337.14(1) and Rule Chapter 14-22. Bidders may obtain preliminary bid results at: <http://www3.dot.state.fl.us/TnspportLASBidLetting/>, select district then click on appropriate date.

DEADLINE for PROPOSALS and PROPOSAL HOLDERS LIST

The deadline for obtaining bid packages shall be 24 hours prior to scheduled letting date. A list of plan holders may be obtained by visiting the District Contracts Administration website at: <http://www.dot.state.fl.us/contractsadministrationdistrict1/>, and select letting date from the District 1 Lettings Menu. Please note that the list of proposal holders is confidential two working days from the deadline for obtaining bid packages (or three working days prior to scheduled letting date) and the list of Proposal, Plan and Specification Holders will be deleted and no longer available, per Florida Statutes 337.168(2).

-----NOTE-----

Proposals will not be issued after 2:00 PM Local Time on Wednesday, January 18, 2012.

Document Ordering Information

Orders for documents are placed using the Contract Proposal Processing Online Ordering System at <http://www.dot.state.fl.us/cc-admin/>. There is no charge for ordering/downloading documents. Online Ordering is available Monday through Friday from 6 AM. to 9 PM. and Saturday from 6 AM. to 7 PM.

To Place An Order

- A current State of Florida Vendor Number is required prior to first-time registration; please visit http://dms.myflorida.com/egovernment_tools/myflorida_marketplace for more information. Please allow 24 to 48 hours for receipt of a new vendor number.
- Prior to placing orders, an individual shall register and establish an Internet Subscriber Account with the Department of Transportation at <http://www.dot.state.fl.us/cc-admin/>. Please allow 48 to 72 hours (excluding weekends and holidays) for the registration and approval.

PREQUALIFICATION

A contractor desiring to bid for the performance of any construction contract in excess of \$250,000.00 must first be certified by the Department as qualified in accordance with Section 337.14(1), Florida Statutes, and Rule 14-22, Florida Administrative Code. Maintenance contracts do not require a contractor to have a certificate of qualification, unless stipulated in the project description and specifications. If deemed necessary by the Department, certain maintenance contracts will contain specific requirements for maintenance contractor eligibility.

SCRUTINIZED COMPANIES

A company that is on the Scrutinized Companies with Activities in Sudan List or the Scrutinized Companies with Activities in the Iran Petroleum Energy Sector List may not bid on, submit a proposal for, or enter into a contract with an agency or local government entity for goods or services of \$1 million or more.

BID REJECTION

Bidders are hereby notified that all bids on any of the following projects are likely to be rejected if the lowest responsive bid received exceeds the engineer's estimate by more than ten percent (10%). In the event any of the bids are rejected for this reason, the project may be deferred for re-advertising. In addition, award of all federally funded projects will be subject to Federal Highway Administration concurrence.

PROTEST RIGHTS

Pursuant to Section 337.11, Florida Statutes, any person adversely affected by a **bid solicitation** shall file both a notice of protest and bond within 72 hours of the receipt of the bid documents, and shall file a formal written protest within ten days after filing the notice of protest. Any person who files a notice of protest as to a bid solicitation pursuant to this rule shall post with the Department, at the time of filing the notice of protest, a bond payable to the Department in the following amounts: For an action protesting a bid solicitation that requires qualification of bidders, the Bond shall be \$5,000. For an action protesting a bid solicitation for which bidders are not required to be prequalified by the Department to be eligible to bid, the bond shall be \$2,500. The required notice of protest, bond and formal protest must each be timely filed with the Clerk of Agency Proceedings, Florida Department of Transportation, Mail Station 58, Room 550, 605 Suwannee Street, Tallahassee, Florida 32399-0458. Failure to file a protest within the time prescribed in Section 120.57(3), Florida Statutes, shall constitute a waiver of proceedings under Chapter 120, Florida Statutes.

Pursuant to Section 337.11, Florida Statutes, any person adversely affected by a **bid rejection or contract award** shall file both a notice of protest and bond within 72 hours after the posting of the Summary of Bids. If notice of intended decision is given by certified mail or express delivery, the adversely effected person must file both the notice of protest and bond within 72 hours after receipt of the notice of intent. A formal written protest must be filed within ten days after filing the notice of protest. Any person who files a notice of protest as to a bid rejection or contract award pursuant to this rule shall post with the Department, at the time of filing the notice of protest, a bond payable to the Department in the following amounts: For an action protesting a bid rejection or contract award that requires qualification of bidders, the Bond shall be equal to one percent of the lowest bid submitted or \$5,000, whichever is greater. For an action protesting a bid rejection or contract award for which bidders are not required to be prequalified by the Department to be eligible to bid, the bond shall be \$2,500. The required notice of protest, bond and formal protest must each be timely filed with the Clerk of Agency Proceedings, Florida Department of Transportation, Mail Station 58, Room 550, 605 Suwannee Street, Tallahassee, Florida 32399-0458. Failure to file a protest within the time prescribed in Section 120.57(3), Florida Statutes, shall constitute a waiver of proceedings under Chapter 120, Florida Statutes.

A protest is not timely filed unless the notice of protest, bond and the formal protest are each received by the Clerk of Agency Proceedings within the required time limits. A protest which is filed prematurely will be deemed abandoned unless timely renewed.

INSURANCE

The successful bidder shall submit current general liability insurance and workman's compensation insurance certificates for the duration of the contract in the dollar amounts and manner specified in the most current edition of the Department's Standard Specifications for Road and Bridge Construction. Insurance companies must be authorized to do business in the State of Florida. Proof of such insurance shall be filed with the District Contracts and Procurement Office before the contract can be executed. BE SURE THAT THE CONTRACT NUMBER IS ON EACH INSURANCE CERTIFICATE.

ADDENDA

No negotiations, decisions, or actions will be initiated or executed by a potential bidder as a result of any oral discussion with a State employee. Only those communications which are in writing from the Department will be considered as a duly authorized expression on behalf of the Department. Notices of changes (addenda) will be posted on the District Contracts Administration website at: <http://www.dot.state.fl.us/contractsadministration/district1/>, and select letting date from the District 1 Lettings Menu. It is the responsibility of all potential bidders to monitor this site for any changing information prior to submitting their bid. **PAGE 397 All addenda will be acknowledged by signature and subsequent submission of addenda**

with the bid when so stated in the agenda.

BID QUESTIONS

Direct questions regarding the advertised projects by posting them to the Department website at the following URL address: <http://www2.dot.state.fl.us/construction/bidquestionmain.asp>

MAINTENANCE

PROPOSAL ID:	E1K79-R0	PROJECT(S): 43174717201 (*)	COUNTY:	HIGHLANDS
DESCRIPTION:	The Improvements under this Contract consist of delivery, placement and maintenance of sod until established in Highlands County.			
	• Contract Days: 365		• Budget Amount: \$136,000.00	
	• Contract Execution Days: 10		• Acquis/Flexible Start Time: N/A	
	• Proposal Package Fee(plans+proposal): \$0.00		• Plans Only Fee: \$0.00	• Specs Only Fee: \$0.00
PROPOSAL ID:	E1K80-R0	PROJECT(S): 43174517201 (*)	COUNTY:	OKEECHOBEE
DESCRIPTION:	The Improvements under this Contract consist of delivery, placement and maintenance of sod until established in Okeechobee County.			
	• Contract Days: 365		• Budget Amount: \$136,000.00	
	• Contract Execution Days: 10		• Plans Only Fee: \$0.00	• Specs Only Fee: \$0.00
	• Proposal Package Fee(plans+proposal): \$0.00		• Plans Only Fee: \$0.00	• Specs Only Fee: \$0.00
PROPOSAL ID:	E1K81-R0	PROJECT(S): 43142017201 (*)	COUNTY:	MANATEE SARASOTA
DESCRIPTION:	The Improvements under this Contract consist of Herbicide Application in Manatee & Sarasota County.			
	• Contract Days: 365		• Budget Amount: \$49,833.00	
	• Contract Execution Days: 10		• Plans Only Fee: \$0.00	• Specs Only Fee: \$0.00
	• Proposal Package Fee(plans+proposal): \$0.00		• Plans Only Fee: \$0.00	• Specs Only Fee: \$0.00
PROPOSAL ID:	E1K82-R0	PROJECT(S): 42943017201 (*)	COUNTY:	MANATEE SARASOTA
DESCRIPTION:	The Improvements under this Contract consist of Highway Lighting Maintenance on the Primary Roadway System in Manatee & Sarasota Counties.			
	• Contract Days: 365		• Budget Amount: \$24,250.00	
	• Contract Execution Days: 10		• Plans Only Fee: \$0.00	• Specs Only Fee: \$0.00
	• Proposal Package Fee(plans+proposal): \$0.00		• Plans Only Fee: \$0.00	• Specs Only Fee: \$0.00
PROPOSAL ID:	E1K83-R0	PROJECT(S): 42942317201 (*)	COUNTY:	HARDEE DESOTO MANATEE SARASOTA
DESCRIPTION:	The Improvements under this Contract consist of Mechanical Sweeping of Bridges, Curbs and Gutters in Hardee, Desoto, Manatee, & Sarasota Counties.			
	• Contract Days: 365		• Budget Amount: \$40,000.00	
	• Contract Execution Days: 10		• Plans Only Fee: \$0.00	• Specs Only Fee: \$0.00
	• Proposal Package Fee(plans+proposal): \$0.00		• Plans Only Fee: \$0.00	• Specs Only Fee: \$0.00
PROPOSAL ID:	E1K84-R0	PROJECT(S): 42946117201 (*)	COUNTY:	MANATEE SARASOTA
DESCRIPTION:	The Improvements under this Contract consist of Herbicide Strip Application in Manatee & Sarasota Counties.			
	• Contract Days: 365		• Budget Amount: \$100,000.00	
	• Contract Execution Days: 10		• Plans Only Fee: \$0.00	• Specs Only Fee: \$0.00
	• Proposal Package Fee(plans+proposal): \$0.00		• Plans Only Fee: \$0.00	• Specs Only Fee: \$0.00
PROPOSAL ID:	E1K85-R0	PROJECT(S): 42941817201 (*)	COUNTY:	MANATEE SARASOTA
DESCRIPTION:	The Improvements under this Contract consist of Edging and Sweeping, Removal and Disposal of Vegetation from Curb and Gutter and Sidewalk Areas in Manatee & Sarasota Counties.			
	• Contract Days: 365		• Budget Amount: \$110,152.00	
	• Contract Execution Days: 10		• Plans Only Fee: \$0.00	• Specs Only Fee: \$0.00
	• Proposal Package Fee(plans+proposal): \$0.00		• Plans Only Fee: \$0.00	• Specs Only Fee: \$0.00
PROPOSAL ID:	E1K86-R0	PROJECT(S): 42944717201 (*)	COUNTY:	MANATEE
DESCRIPTION:	The Improvements under this Contract consist of Roadside Mowing, Litter Removal, and Chemical Vegetation Control using inside Mowing Deck Application in Manatee County.			
	• Contract Days: 365		• Budget Amount: \$315,000.00	
	• Contract Execution Days: 10		• Plans Only Fee: \$0.00	• Specs Only Fee: \$0.00
	• Proposal Package Fee(plans+proposal): \$0.00		• Plans Only Fee: \$0.00	• Specs Only Fee: \$0.00

PROPOSAL ID: E1K87-R0 PROJECT(S): 42772117201 (*)

COUNTY: DESOTO

DESCRIPTION:

The Improvements under this Contract consist of Roadside Mowing, Litter Removal, Under Deck Herbicide Application and Edging and Sweeping in Desoto County.

- Contract Days: 365
- Contract Execution Days: 10
- Proposal Package Fee(plans+proposal): \$0.00
- Budget Amount: \$342,000.00
- Plans Only Fee: \$0.00
- Specs Only Fee: \$0.00

PROPOSAL ID: E1K88-R0 PROJECT(S): 42772217201 (*)

COUNTY: HARDEE

DESCRIPTION:

The Improvements under this Contract consist of Roadside Mowing, Litter Removal, Under Deck Herbicide Application and Edging and Sweeping in Hardee County.

- Contract Days: 365
- Contract Execution Days: 10
- Proposal Package Fee(plans+proposal): \$0.00
- Budget Amount: \$251,500.00
- Plans Only Fee: \$0.00
- Specs Only Fee: \$0.00

BID BOND

For bids over \$150,000.00, the standard proposal guaranty of 5% of the bid will be required. A Proposal Guaranty of not less than five percent (5%) of the total actual bid in the form of either a certified check, cashier's check, trust company treasurer's check, bank draft of any national or state bank, or a Surety Bid Bond made payable to the Florida Department of Transportation must accompany each bid in excess of \$150,000.00. A check or draft in an amount less than five percent (5%) of the actual bid will invalidate the bid. The guaranty amount shall include all bid items except construction days for A+B bidding and lane closure for Lane Rental Bidding. Bid Bonds shall conform to DOT Form 375-020-09 furnished with the Proposal. Surety2000 or SurePath electronic Bid Bond submittal may be used in conjunction with Bid Express internet bid submittal. For more information please visit <http://www.surety2000.com> for Surety2000 or <http://www.insurevision.com> for SurePath. Paper Bid Bonds will be also be accepted for bids submitted through Bid Express provided they are received prior to the deadline for receiving bids, by the location(s) identified in this Bid Solicitation Notice for receiving bids for the advertised project(s).

PREQUALIFIED CONTRACTORS CURRENT CAPACITY

In order for the Department to have the information required to determine a prequalified bidder's Current Capacity, it is necessary that the prequalified contractor certify the total dollar amount of all work the contractor has underway. This certification shall be accomplished electronically by submitting the Certification of Work Underway (Online Web Application) http://www.dot.state.fl.us/cc-admin/PreQual_Info/prequalified.shtm to the Department concurrently with the bid submittal for the first letting in the calendar month that the contractor submits a bid.

EXECUTION OF CONTRACT

Pursuant to Subsections 3-6 and 3-7 of the Standard Specifications, the successful bidder shall execute the necessary contract documents and return the agreement along with a satisfactory Performance and Payment Bond within ten (10) Calendar days of award, excluding Saturdays, Sundays, and state holidays, unless noted otherwise in the project specifications. A 100% Payment and Performance Bond will be required for all projects unless noted otherwise in the project specifications. All work is to be done in accordance with the Plans, special Provisions of the State of Florida Department of Transportation.

Prior to execution of the contract with the Department, a corporation must show proof that is authorized to do business in the State of Florida. Florida corporations should provide a copy of the certificate of Incorporation and foreign corporations should provide a copy of Certificate of Authority from the Florida Department of State.

Important note: Actual commitment and final execution of the contract is contingent upon an approved legislative budget and funds availability.

PROPOSAL REVISIONS

The Department will accept legible facsimile (fax) proposal revisions pursuant to the project specifications at Fax No. (863) 519-2661 if received in full by 2:00 PM Local Time on the day of the letting. A faxed proposal revision will not be considered if received at a different fax number. The bid/proposal must be received in the District Contracts and Procurement Office prior to receiving changes through the Fax.

DBE PARTICIPATION

Disadvantaged Business Enterprise (DBE) Availability Goal Information is contained in the Bid Solicitation Package. Please complete, sign, and return the applicable "Anticipated DBE Participation Statement" form and the "DBE/MBE Bid Opportunity List" form which shall be submitted with bid as stipulated in the subject bid packages.

DEBARMENT/SUSPENSION

All bids submitted to the Department shall include a statement that by signing and submitting this proposal, the bidder certifies that no principal (which includes officers, directors or executives) is presently debarred, suspended, proposed for debarment, declared ineligible or voluntarily excluded from participation in this transaction by any federal department or agency.

MANDATORY PRE-BID CONFERENCE

Proposal forms (bid packages) will be issued only to attendees of the mandatory pre-bid conference (if there is a mandatory pre-bid conference for a project).

LATE ARRIVALS TO MANDATORY PRE-BID MEETINGS

All bidders must be present and signed in prior to the start of the mandatory prebid meeting. Anyone not signed in at the commencement of the meeting will be considered late and will not be allowed to bid on the project.

FIRST TIME BIDDERS

Bidders bidding for the first time with the Department can request an orientation meeting to obtain information about the bidding/contracting process. Contact the office listed for ordering plans. Please call (863) 519-2559 or (800) 292-3368 for further details.

POSTING NOTICE

Unless otherwise notified by certified mail, express delivery, hand delivery, fax, or email, receipt acknowledgment, the Summary of Bids will be posted at the District Contracts Administration web site <http://www.dot.state.fl.us/contractsadministrationdistrict1/>, and select letting date from the District 1 Lettings Menu, on **February 07, 2012** or in the alternative **February 14, 2012**. Additionally a hard copy will be posted on the first floor bulletin board at the District One Headquarters Building, Florida Department of Transportation, District Office Complex, 801 North Broadway Avenue, Bartow, Florida 33830, and will remain posted for a period of seventy-two (72) hours. By calling (863) 519-2559, during each posting period, information concerning the posted projects can be obtained. The posting provides notice of the Department's intent to award a contract or reject all bids. The Department's Notice of Intent regarding a project will be posted on only one of the alternate posting dates. Bidders are solely responsible for timely monitoring or otherwise verifying on which of the specified alternate posting dates the posting of award or rejection of all bids actually occurs.

If the posting dates are revised, all bidders for the subject project will be notified of the Department's intended decision. Bidders must acknowledge receipt of the notice of the revised date.

AFFIRMATIVE ACTION (EQUAL EMPLOYMENT OPPORTUNITY)

The Florida Department of Transportation (hereinafter referred to as the "Department"), in accordance with Title VI of the Civil Rights Act of 1964, 42 USC 2000d to 2000d-4 and related authorities, Title 49, Code of Federal Regulations, U.S. Department of Transportation, Subtitle A, Office of the Secretary, Part 21, Nondiscrimination in Federally-assisted programs of the U.S. Department of Transportation issued pursuant to such Act, hereby notifies all bidders that the Department will affirmatively insure that in any contract entered into pursuant to this advertisement, minority and disadvantaged business enterprises will be afforded the full opportunity to submit bids in response to this invitation and will not be discriminated against on the basis of race, color, national origin, religion, sex, age, or disability/handicap in consideration for an award. Further, it is the policy of the Department to not discriminate against bidders on the grounds of race, color, national origin, religion, sex, age, or disability/handicap in consideration for an award. A bidder must have an approved DBE Affirmative Action (DBE/AA) Plan prior to contract award. Please use the following link http://www.dot.state.fl.us/cc-admin/cpp_online_ordering/bidder_assist.shtm and the Special Provisions for instructions for

submission of a DBE/AA Plan. The DBE/AA Plan should be submitted for approval prior to the bidding.

MINIMUM WAGE

The minimum wage for all hours worked in Florida shall be \$7.31 per hour, effective June 1, 2011.

EMAIL SUBSCRIPTION LIST

To get on the e-mail subscription list, go to <http://www2.dot.state.fl.us/ContractsAdministration/bsnmail.asp> and fill out the necessary information to "Subscribe". To obtain information concerning other districts, go to <http://www.dot.state.fl.us/cc-admin/distco.shtm>

STATE OF FLORIDA DEPARTMENT OF TRANSPORTATION

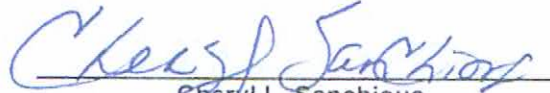

Cheryl L. Sanchious
District Contracts Administrator

NOTICE TO ALL BIDDERS

To report bid rigging activities call: 1-800-424-9071

The U.S. Department of Transportation (DOT) operates the above toll-free "hotline" Monday through Friday, 8:00 a.m. to 5:00 p.m. local time. Anyone with knowledge of possible bid rigging, bidder collusion, or other fraudulent activities should use the "hotline" to report such activities. The "hotline" is part of the DOT's continuing effort to identify and investigate highway construction contract fraud and abuse and is operated under the direction of the DOT Inspector General. All information will be treated confidentially and caller anonymity will be respected.



PROPOSAL OF

Star Cleaning USA Inc

(Proposer's Firm Name) (Prequalified Name, if Applicable)

1966A SW 69 Pl, Pembroke Pines FL 33332

(Proposing Firm's Physical Address - City - State - Zip)

F.E.I.D. No. 65-0684451 Telephone No. (954) 680-7827 FAX No. (954) 434-6967

Email Address: StarCleaningUSA@hotmail.com

for constructing or otherwise improving a Bridge(s) and/or Section(s) of Road(s) No(s). or building(s) On the primary

in Hardee, Desoto, Manatee, & Sarasota County(ies),

The Improvements under this Contract consist of Mechanical Sweeping of Bridges, Curbs and Gutters

approximately N/A

in length, and known as Federal Aid Project No(s): N/A

Contract No.: E1K83-R0 Financial Project No(s): 429423-1-72-01

TO THE STATE OF FLORIDA, DEPARTMENT OF TRANSPORTATION: Submitted

The Bidder, hereby declares that no person or persons, firm or corporation, other than the Bidder, is interested, in this proposal, as principals, and that this Proposal is made without collusion with any person, firm or corporation, and we have carefully and to our full satisfaction examined the Proposal forms, the Standard Specifications as amended by the Specifications Package and any Supplemental Specifications Packages, and the Plans, and that we have made a full examination of the location of the proposed work and the sources of supply of materials, and we hereby agree to furnish all necessary labor, equipment, and materials, fully understanding that the quantities shown herewith are approximate only, and that we will fully complete all necessary work in accordance with the Plans and Specifications, and the requirements under them of the Engineer, within the time limit specified in this Proposal for the following unit prices, to wit:

Was an addendum issued on this project?

Yes No

Table with 4 columns: Addendum No., Dated, Addendum No., Dated. Header: I (We) hereby acknowledge receipt of the following Addenda issued during the bidding period.

The Bidder hereby declares that the undersigned is the person or persons responsible within the firm for the final decision as to the price(s) and amount of this bid and the Bidder further declares that:

1. The price(s) and amount of this bid have been arrived at independently, without consultation, communication, or agreement for the purpose of restricting competition with any other contractor, bidder or potential bidder.
2. Neither the price(s) nor the amount of this bid have been disclosed to any other firm or person who is a bidder or potential bidder on this project, and will not be so disclosed prior to the bid opening.
3. No attempt has been made or will be made to solicit, cause, or induce any firm or person to refrain from bidding on this project, or to submit a bid higher than the bid of this firm, or any intentionally high or non-competitive bid or other form of complementary bid.
4. The bid is made in good faith and not pursuant to any agreement or discussion with, or inducement from, any other firm or person to submit a complementary bid.
5. The Bidder has not offered or entered into a subcontract or agreement regarding the purchase of materials or services from any other firm or person, or offered, promised, or paid cash or anything of value to any other Bidder or person, whether in connection with this or any other project, in consideration for an agreement or promise by any other firm or person to refrain from bidding or to submit a complementary bid on this project.
6. The Bidder has not accepted or been promised any subcontract or agreement regarding the sale of materials or services to any other firm or person, and has not been promised or paid cash or anything of value by any other firm or person, whether in connection with this or any other project, in consideration for the firm's submitting a complementary bid, or agreeing to do so, on this project.
7. The Bidder has made a diligent inquiry of all members, officers, employees, and agents of the Bidder with responsibilities relating to the preparation, approval or submission of the firm's bid on this project and have been advised by each of them that he or she has not participated in any communication, consultation, discussion, agreement, collusion, act, or other conduct inconsistent with any of the statements and representations made in this Declaration.
8. As required by Section 337.165, Florida Statutes, the Bidder has fully informed the Florida Department of Transportation in writing of all convictions of the firm, its affiliates (as defined in Section 337.165(1)(a), Florida Statutes), and all directors, officers, and employees of the firm and its affiliates for violation of state or federal antitrust laws with respect to a public contract or for violation of any state or federal law involving fraud, bribery, collusion, conspiracy, or material misrepresentation with respect to a public contract. This includes disclosure of the names of current employees of the firm or affiliates who were convicted of contract crimes while in the employ of another company.
9. The Bidder certifies that, except as noted below, neither the firm nor any person associated therewith in the capacity of owner, partner, director, officer, principal, investigator, project director, manager, auditor, and/or position involving the administration of federal funds:
 - (a) is presently debarred, suspended, proposed for debarment, declared ineligible, or voluntarily excluded from covered transactions, as defined in 49 CFR s29.110(a), by any federal department or agency;
 - (b) has within a three-year period preceding this certification been convicted of or had a civil judgment rendered against it for: commission of fraud or a criminal offense in connection with obtaining, attempting to obtain, or performing a federal, state, or local government transaction or public contract; violation of federal or state antitrust statutes; or commission of embezzlement, theft, forgery, bribery, falsification or destruction of records, making false statements, or receiving stolen property;
 - (c) is presently indicted for or otherwise criminally or civilly charged by a federal, state, or local governmental entity with commission of any of the offenses enumerated in paragraph 9(b) of this certification; and
 - (d) has within a three-year period preceding this certification had one or more federal, state, or local government public transactions terminated for cause or default.
10. The Bidder certifies that it shall not knowingly enter into any transaction with any subcontractor, material supplier, or vendor who is debarred, suspended, declared ineligible, or voluntarily excluded from participation in this project by any federal agency unless authorized by the Florida Department of Transportation.
11. The firm certifies that the bidder is not a nonresident alien, or a foreign corporation/entity formed under the laws of a country other than the United States.
12. The Bidder certifies that the company is not on the Scrutinized Companies with Activities in Sudan List or the Scrutinized Companies with Activities in the Iran Petroleum Energy Sector List.

Where the Bidder is unable to declare or certify as to any of the statements contained in the above stated paragraphs numbered (1) through (12), the Bidder has provided an explanation in the "Exceptions" portion on page 4 of 4 or by attached separate sheet.

EXCEPTIONS:

Any exception listed above will not necessarily result in denial of award, but will be considered in determining bidder responsibility. For any exception noted, indicate to whom it applies, initiating agency, and dates of agency action. Providing false information may result in criminal prosecution and/or administrative sanctions. I declare under penalty of perjury that the foregoing is true and correct.

<p>CORPORATION: <u>Star Cleaning USA Inc.</u></p> <p>Signature: <u><i>[Signature]</i></u> Bidder President or Vice President (Circle Title)</p> <p><u>ENRIQUE GONZALEZ</u> Print Name</p> <p>(Affix Corporate Seal)</p>	<p>INDIVIDUAL OR FIRM TRADING AS:</p> <p>_____ Bidder</p> <p>Signature: _____ Individual or Owner</p> <p>_____ Print Name</p>
<p>PARTNERSHIP</p> <p>_____ Bidder</p> <p>Signature: _____ General Partner (Circle Title)</p> <p>_____ Print Name</p> <p>Signature: _____ General Partner (Circle Title)</p> <p>_____ Print Name</p>	<p>JOINT VENTURE:</p> <p>_____ Bidder</p> <p>Signature: _____ Attorney-in-Fact</p> <p>_____ Print Name</p>
<p>LIMITED LIABILITY COMPANY:</p> <p>_____ Contractor</p> <p>Signature: _____ Manager or Member (Circle Title)</p> <p>_____ Print Name</p>	<p>CONTRACTOR: _____ (Seal)</p> <p>Signature: _____ President or Vice President (Circle Title)</p> <p>CONTRACTOR: _____ (Seal)</p> <p>Signature: _____ President or Vice President (Circle Title)</p> <p>CONTRACTOR: _____ (Seal)</p> <p>Signature: _____ President or Vice President (Circle Title)</p>
<p>Organized and existing under the laws of the State of <u>FLORIDA</u> and authorized to do business in the State of Florida, pursuant to the laws of the State of Florida, certificate of incorporation or organization or certificate of authority having been issued by the Florida Department of State.</p>	

FAILURE TO FULLY COMPLETE AND EXECUTE THIS DOCUMENT MAY RESULT IN THE BID BEING DECLARED NONRESPONSIVE

ATTACH BID BOND

Job No(s):

429423-1-72-01

To: Honorable Mayor, Vice-Mayor and Members of the Town Commission
From: Guillermo Olmedillo, Town Manager
Date: April 14, 2020
Subject: Design Review Board

Previously, the Town's design review process included two boards, the Planning and Zoning Board and the Design Review Board. The Planning and Zoning Board consisted of 5 members appointed by the Town Commission. The Design Review Board included the 5 Planning and Zoning Board Members and required two additional members and would meet on the same night. One of the additional members had to be a Florida-licensed architect or landscape architect while the second member could be an architect, landscape architect, engineer, city planner, general contractor, interior designer, or attorney.

Because these two Boards had overlapping members and functions, it proved difficult to have a quorum, specifically for the Design Review Board as one of the two additional members had to be present. If not present, the meeting was canceled and items to be heard were rescheduled to the following meeting. Also, there was difficulty finding and appointing qualified persons to serve on the Design Review Board. Ordinance No. 18-1689 adopted on April 14, 2018 (codified in Sections 90-14 to 90-23 of the Town Code), incorporated the functions of the Design Review Board within the Planning and Zoning Board. In addition, two alternate members were added to the Planning and Zoning Board to ensure that a quorum exists for each meeting. If all five members of the Planning and Zoning Board are in attendance, the two alternates become non-voting members.

The 2018 Ordinance dissolved the Design Review Board and provided for design review functions to be incorporated and taken up by the Planning and Zoning Board. The newly constituted Planning and Zoning Board is made up of seven members, two of which are alternates who vote when any member of the Planning and Zoning is not present. The requirements were also modified to indicate that three of the members, which include the alternates, must have specific qualifications. Previously, only Design Review members were required to have qualifications.

Since the adoption of the Ordinance in 2018 that dissolved Design Review and provided for the functions by the Planning and Zoning Board, the Planning and Zoning Board has not had to cancel a meeting due to a lack of a quorum. Those applications needing approval based on design review are processed at the beginning of the meeting followed by those items that require approval for consistency with the Zoning Code. In sum, design review functions still occur as required by the Town Code, but are performed by the Planning & Zoning Board.

Staff recommends the design review function remain with the Planning and Zoning Board to avoid quorum issues and overlapping functions and provide for a clear, concise and timely process for applicants.

ORDINANCE NO. 18 - 11689

AN ORDINANCE OF THE TOWN OF SURFSIDE, FLORIDA AMENDING CHAPTER 90 “ZONING” OF THE TOWN OF SURFSIDE CODE OF ORDINANCES TO ABOLISHING THE DESIGN REVIEW BOARD, MODIFYING THE PLANNING AND ZONING BOARD MEMBERSHIP AND RESPONSIBILITIES, ABOLISHING THE DEVELOPMENT IMPACT COMMITTEE, AND REVISING THE DESIGN REVIEW GROUP REVIEW REQUIREMENTS; PROVIDING FOR REPEAL OF CONFLICTING PROVISIONS; PROVIDING FOR SEVERABILITY; PROVIDING FOR INCLUSION IN THE CODE; AND PROVIDING FOR AN EFFECTIVE DATE.

WHEREAS, the Town Commission of the Town of Surfside, Florida, recognizes that changes to the adopted Code of Ordinances are periodically necessary in order to ensure that the Town’s regulations are current and consistent with the Town’s planning and regulatory needs; and

WHEREAS, the Town wishes to abolish the Design Review Board and provide for design review by the Planning and Zoning Board so the functions of zoning and design review are consolidated in the Planning and Zoning Board; and

WHEREAS, the Town desires to abolish the Development Impact Committee to reduce duplicative efforts and consolidate review in the administrative design review process; and

WHEREAS, the Town Commission held its first public hearing on these regulations on August 14, 2018; and

WHEREAS, the Planning and Zoning Board, sitting as the Local Planning Agency, has reviewed the revisions to the Code for consistency with the Town’s Comprehensive Plan at a duly noticed hearing on August 30, 2018 and

WHEREAS, the Town Commission has conducted a second duly noticed public hearing on these regulations as required by law on August 14, 2018; and

WHEREAS, the Town Commission hereby finds and declares that adoption of this Ordinance is necessary, appropriate, and advances the public interest.

NOW THEREFORE, BE IT ORDAINED BY THE TOWN COMMISSION OF THE TOWN OF SURFSIDE, FLORIDA, AS FOLLOWS:

Section 1. Recitals. Each of the above stated recitals is true and correct and the recitals are incorporated herein by this reference.

Section 2. Code Amendment. The Code of Ordinances of the Town of Surfside, Chapter 90 “Zoning,” is hereby amended as follows¹:

* * *

DIVISION 1. - PLANNING AND ZONING BOARD

Sec. 90-14. - Created.

There is created a town planning and zoning board.

Sec. 90-15. - Membership/quorum, minimum qualifications, officers, terms of officers, vacancies, general regulations, recommendations, expenditures, indebtedness.

(1) *Membership/quorum:* The planning and zoning board membership and quorum requirements for zoning matters and design review matters are as follows:

(a) *Zoning matters:* The planning and zoning board, ~~when performing its zoning functions,~~ shall consist of five members and a first alternate member and a second alternate member. ~~At least three of the Two~~ members or alternates must be one of the following:

1. Florida-licensed general contractor or a construction management professional with at least three years of professional experience as a construction project manager, construction superintendent or construction estimator;
2. Florida licensed PE or a civil, mechanical, electrical, chemical or environmental engineer with a baccalaureate degree in engineering and three years of professional experience;
3. Certified planner (AICP) or a planning professional with a graduate degree in planning from a program accredited by the Planning Accreditation Board with at least three years of professional planning experience or a bachelor's degree in planning from a program, accredited by the Planning Accreditation Board (PAB) with at least three years of professional planning experience;
4. Florida-licensed landscape architect with at least three years of professional experience;
5. Registered interior designer with at least three years of professional experience;
6. Florida-licensed attorney with at least three years of professional experience;
7. Florida-licensed architect; or
87. Real estate developer with three years of professional experience, either as the principal or executive.

¹ Additions to text are shown in yellow underline. Deletions to text are shown in ~~yellow strikethrough~~.

- (b) *Alternate participation.* Alternates shall be subject to the same attendance and participation requirements as members. Alternates may participate in all board discussions but may not vote unless sitting as a substitute for a member. In the event a member is absent or unable to participate in an item before the board, the first alternate or if the first alternate is unavailable, the second alternate, shall fill the absent or recused member's position for the duration of that member's absence.
- (c) *All board matters:* One town commissioner shall be a liaison, non-voting representative without a vote at all planning and zoning board meetings.
- (2) *Minimum board member qualifications:* All board members must have been a town resident for a minimum period of one year, except for the licensed architects, including the Florida-licensed landscape architect, if applicable, who must have been a town residents for a minimum period of six months. ~~The Florida-licensed architects must have a minimum of five years of practical experience in the field of landscape design. To the extent that no licensed architect (whether for service on the planning and zoning board or design review board only as more specifically described in section 90-18 hereinbelow) who is also a town resident can be identified and is willing to serve at the time of appointment to either board, then the commission may select a non-resident architect who otherwise fulfills the requirements of this section, provided that appointment shall be ratified by a majority of the board of commissioners. To the extent an architect (resident or non-resident) cannot be located within three (3) months of the vacancy, this requirement may after a majority vote of the commission become null and void until such time this board member vacates the position before his/her term expires or a full new board is appointed whichever comes first.~~
- (3) *Officers:* The board shall elect one of its members as chairman and one of its members as vice-chairman, at its first regular meeting in April of each year. In the event of the resignation, removal, or inability of the chairman to serve, the vice-chairman shall succeed to the chairman position for the unexpired term; and the board shall, thereupon, elect one of its members as vice-chairman for the unexpired term. The chairman shall preside at all meetings. In the chairman's absence, the vice-chairman shall preside. The chairman shall submit all board reports and recommendations to the town commission, by and through the chairman, vice-chairman or the town commission liaison member. The town shall provide a secretary for the board and the town clerk shall be custodian of all records, books and journals of the board.
- (4) *Board member term(s):* Each commissioner shall be responsible for one board member appointment. The first and second alternates shall be appointed at-large by the majority vote of the Commission present at the meeting. The term of each board member and alternate appointment shall begin on the last Thursday of April of the year in which the board member or alternate is appointed and end when a successor ~~board member~~ is appointed or on the last Thursday in April, whichever dates comes first. The term of any board member or alternate filling a vacancy created on the board as provided in paragraph (5) shall begin at the time of the ~~board members~~ appointment and end the last Thursday in April or whenever a replacement is appointed.
- (5) *Vacancies:* A vacancy shall exist: (1) on the date that any member or alternate ceases to possess the minimum required membership qualifications provided herein; (2) when a board member or alternate has been absent from three consecutive regularly convened board

meetings or has been absent from five regularly convened board meetings within a board year; or (3) for members if the appointing commissioner resigns or his position otherwise becomes vacant during his/her term. Vacancies on the board shall be filled by appointment for the unexpired term in the same manner as original appointments are made provided however, if the seat shall remain vacant longer than a three-month period for any reason, the town commission may collectively, by majority vote, appoint a temporary member until such commission position is filled in accordance with the Town Charter and Code.

~~(6) *Transition provision:* Inasmuch as the enactment of Ordinance No. 1598 will occur mid-term, and the planning and zoning board as currently composed contains no architect, any architect currently serving on the design review board at the time of enactment, shall continue to serve in an ex officio capacity with the planning and zoning board as a nonvoting member and that the comments of that ex officio member will be considered and accorded equal weight with those who vote. Upon the expiration of the term of the current planning and zoning board, this provision shall become null and void.~~

(7) *General regulations governing members:* Board members and alternates shall be appointed in accordance with all applicable state, county and town ethics laws, rules and regulations. Appointed members and alternates of the board shall not, during their term, hold any other public office, paid position or serve on any other board under town government, except as a temporary board member, or that of a voluntary fireman.

(8) *Expenditures; indebtedness:* The town commission may authorize the expenditure by the planning and zoning board of such funds as the town commission may deem necessary to perform the requirements of this chapter. The town commission may appropriate from the general fund as set up in the annual budget and such sums as it may from time to time authorize the board to expend. The board may not incur indebtedness without prior commission approval.

Sec. 90-16. - Meetings: board year; timeframe; order of presentation; location.

(1) *Board year:* The board year shall commence on the last Thursday of April in each year.

(2) *Meetings on zoning and design review matters/timeframe:* Regular board meetings for zoning and design review matters shall be held on the last Thursday of each month. The chair may call special meetings and may cancel or continue meetings as may be necessary.

~~(3) *Meetings on design review matters/timeframe:* The board shall meet as needed on design review matters. The chairman may call special meetings and may cancel or continue meetings as may be necessary.~~

~~(4) *Order of presentation for zoning matters and design review matters:* In order to avoid unnecessary project costs and delays, the board shall address and finalize each project zoning matter prior to initiating each project design review, to the extent applicable.~~

~~(35) *Location of all board meetings:* All board meetings shall be held in the Town Hall or Community Center.~~

Sec. 90-17. - Powers and duties.

(1) *Zoning matters:* The planning and zoning board shall act as an advisory board to the town commission on zoning matters and design review matters. The boards' powers and duties are as follows:

- (a) To perform its responsibilities as the local planning agency pursuant to local and state government comprehensive planning and land development regulations (F.S. Ch. 163);
 - (b) To review and make recommendations to the town manager and the town commission regarding the adopting and amendment of the official zoning map; the land development regulations amendments; zoning district boundary changes; and comprehensive plan amendments;
 - (c) To review and make recommendations to the town commission, on applications pertaining to site plans (if applicable) zoning changes, special use permits, conditional use variances vested rights and any other zoning applications;
 - (d) To conduct such studies and investigations required under the Town Code and/or requested by the town commission and as needed from time to time to sit in a joint session with the town commission as requested by the town commission; and
 - (e) The planning and zoning board shall have such other duties pertaining to zoning matters as prescribed by law, this section and the Town Code.
- (2) *Design Review :* The planning and zoning board shall conduct a design review for all structures to be constructed and renovated within town limits on the terms outlined below.
- (3) *FEMA review:* The planning and zoning board ~~when constituted as a design review board as set forth in section 90-18 herein below,~~ shall act as the variance and appeals board pursuant Chapter 42, "Floods," Division 6, Variance Procedures, sections 42-111 through 42-117.

Sec. 90-18. - Design Review. ~~Board.~~

- ~~(a) *Membership.* The planning and zoning board, when performing its design review and FEMA variance and appeals board functions shall be constituted as the design review board and shall have seven members. The seven members shall include the five members appointed by the town commission for the planning and zoning board and two additional members, at least one of the design review board members shall be a Florida-licensed architect or Florida-licensed landscape architect. The second design review board member shall be a Florida-licensed architect or a:~~
- ~~(1) Florida-licensed general contractor or a construction management professional with at least three years of professional experience as a construction project manager, construction superintendent or construction estimator;~~
 - ~~(2) Florida-licensed PE or a civil, mechanical, electrical, chemical or environmental engineer with a baccalaureate degree in engineering and three years of professional experience;~~
 - ~~(3) Certified planner (AICP) or a planning professional with a graduate degree in planning from a program accredited by the Planning Accreditation Board with at least three years of professional planning experience or a bachelor's degree in planning from a program, accredited by the Planning Accreditation Board (PAB) with at least three years of professional planning experience;~~

- ~~(4) Florida licensed landscape architect with at least three years of professional experience;~~
- ~~(5) Registered interior designer with at least three years of professional experience;~~
- ~~(6) Florida licensed attorney with at least three years of professional experience; or~~
- ~~(7) Real estate developer with three years of professional experience, either as the principal or executive.~~

~~Both of these members shall be appointed by a majority of the town commission. Four members present at the planning and zoning board design review meetings shall constitute a quorum and at least one of the four members shall be a design review board member.~~ The design review process is set forth as follows.

~~(ab)~~ *Design review process.*

(1) *Purpose.* This section is intended to promote excellence in architectural and urban design; preservation of the town's historic and architectural and neighborhood character; and desirable urban growth and development. To implement this goal, the ~~design review board is hereby created to review and make advisory recommendations to the~~ planning and zoning board ~~shall review and evaluate applications~~ as to whether the design of new developments and/or improvements within the town are consistent with and in conformance with the design guidelines set forth in the Town Code. The design guidelines are attached thereto as Exhibit A [at the end of this chapter] provided that the town commission may amend said guidelines from time to time via resolution. The guidelines as amended, shall govern and be applied as fully set forth herein.

(2) *Design review procedure:*

- a. All applications for new developments or improvements that are subject to the town's adopted design guidelines shall be referred to the planning and zoning board for review and consideration.
- b. The board shall review each application whether for development of single-family, multifamily, commercial or other districts for conformity with the town's adopted design guidelines and ~~recommend the application to the planning and zoning board for approval, approval~~ with conditions, or ~~disapproval of the design review~~ application. With regard to the design review process, no applicant shall be required to appear before the ~~design review~~ board more than twice per application.
- c. Meetings held by the board for review and recommendations of applications shall be arranged to permit participation by the person or group making the application or request and representatives of such person or group, if desired. Architectural plans and drawings of the building facades, lists of finish materials and other information necessary to provide adequate insight into the proposed development/improvement shall be provided to the board by the person or group making the proposal or request.
- ~~d. For design review applications that are not otherwise heard by the planning and zoning board, appeal of any design review board decision may be taken by an interested party to the town commission within 30 days of the hearing at which the design review board makes its final decision, by the filing of a notice of the appeal with the town commission. The appeal shall be heard as a quasi-judicial matter.~~

(3) Design review application fees are set forth in the town designated fee schedule.

(4) Design review applications which are made in conjunction with other development approval applications may be reviewed and considered concurrently with related development approval applications.

~~(4) All meetings of the design review board shall be publicly noticed.~~

Sec. 90-19. - Single-family and two-family development review process.

* * *

90-19.5 Design guidelines. The town has adopted design guidelines intended to provide direction and suggestions for all development. The purpose of the planning and zoning board when conducting design review ~~design review board~~ is to interpret those guidelines and provide guidance to the applicants as to how the design should be revised to more closely approximate or reflect the town's adopted guidelines. The applicant shall then incorporate those suggestions prior to proceeding to building permit.

90-19.6 Single-family and two-family development shall be reviewed by the planning and zoning board ~~design review board~~. The following types of applications shall require noticing as described below:

- (1) Construction of new single-family homes.
- (2) Partial demolition and rebuilding of at least 50 percent of the square footage of a single-family home where the exterior facade of the structure is affected.
- (3) An addition of at least 50 percent of the square footage of the existing single-family home.

The applicant shall notify the public of the planning and zoning board ~~design review board~~ hearing date and location, on the proposed application as follows:

- a. The applicant shall post a notice on the property one week prior to the planning and zoning board ~~design review board~~ meeting and remove the notice three days after the conclusion of the planning and zoning board ~~design review board~~ meeting. A notice, 18 inches by 24 inches, shall be placed in a prominent place on the property by the applicant, denoting the following:

REQUEST FOR: _____

PLANNING AND ZONING BOARD ~~DESIGN REVIEW BOARD~~ MEETING:

DATE AND TIME

TOWN HALL
9293 Harding Avenue
Surfside, FL 33154

COMPLETE INFORMATION REGARDING THE APPLICATION IS AVAILABLE BY CONTACTING THE TOWN HALL.

- b. The applicant shall mail written courtesy notices via certified mail, to the abutting single-family property owners and single-family property owners parallel to the

subject property line across any right-of-way, of the planning and zoning board ~~design review board~~ meeting date and location ten days prior to the meeting.

- c. The applicant shall provide the town the corresponding certified mail receipts, indicating the notices have been mailed and provide evidence that the sign has been posted three days prior to the planning and zoning board ~~design review board~~ meeting.

90-19.7 The following shall be exempt from planning and zoning board and ~~design-review board~~ review; however, the design guidelines shall be followed:

- (1) Interior or rear yard fences.
- (2) Interior renovations.
- (3) Single-family and two-family Awnings.
- (4) Screens.
- (5) Driveways.
- (6) Re-roofs
- (7) Trellis.
- (8) Rooftop photovoltaic solar systems.
- (9) Sheds.

90-19.8 The following are required for submittal to the planning and zoning board for design review applications ~~design review board~~:

* * *

90-19.9 *Effective period of* planning and zoning board design review ~~design review board approval~~. An design review approval from the planning and zoning board ~~design review board~~ shall be effective until the development is completed except that if, after 24 months from the date of the approval by the planning and zoning board ~~design review board~~ a building permit for a principal building has not been issued and remains in effect, the approval shall be null and void.

- (1) Extensions for good cause, not to exceed a total of one year for all extensions, may be granted by the town commission, at its sole discretion, provided the applicant submits a request in writing to the town manager or designee in advance of the expiration of the original approval, setting forth good cause for such an extension. For the purpose of this Section, a building permit for a principal building shall cease to be in effect once required inspections have lapsed or once a certificate of completion or certificate of occupancy is issued.
- (2) All approvals which have been granted prior to the effective date of this chapter, shall be null and void and of no further force or effect if not utilized within two years after the effective date of this chapter, unless vested rights are demonstrated pursuant to subsection 90-5(11) of the zoning code. The foregoing provision of this paragraph shall not apply if the governmental resolution granting the approval expressly established a specific time limitation for utilizing the approval. In such instances, the time limitation established by such resolution shall prevail.

Sec. 90-20. - Development review requirements for submittals other than single-family and two-family.

- (1) Generally. Review and approval of a site plan by staff reviewing agencies, ~~the design review board,~~ and ~~the development impact committee,~~ the planning and zoning board, and the town commission is required prior to any development of land in the town.
- (2) Process. Submit plans (sets to be determined by town staff as appropriately needed), which are distributed to the staff members of the development review group (DRG).

- (a) The DRG member shall review the site plan and prepare comments. The comments shall be forwarded to the town manager or designee. The comments shall be addressed by the applicant, if applicable. The town manager or designee shall hold a development review group meeting with appropriate town staff and the applicant to discuss the comments. In reviewing an application each reviewer shall consider, and comment as appropriate, on applicable issues relevant to their particular area of expertise, the extent to which:

- i. The development, as proposed, conforms to the comprehensive plan and the zoning code;

- ii. The development, as proposed, will have a favorable or unfavorable impact on the environment and natural resources, including a consideration of the means and estimated cost necessary to minimize the adverse impacts, if any;

- iii. The development, as proposed, will have a favorable or unfavorable impact on the economy of the Town of Surfside;

- iv. The development, as proposed, will efficiently use or unduly burden water, sewer, solid waste disposal, education, recreation or other necessary public facilities which have been constructed or planned and budgeted for construction in the area;

- v. The development, as proposed, will efficiently use or unduly burden or affect public transportation facilities, including mass transit, public streets, and roads, which have been planned and budgeted for construction in the area, and if the development is or will be accessible by private or public roads or streets.

- vi. The development, as proposed, is consistent with the community character of the immediate neighborhood. In addition to consistency there must be congruity between the subject development and neighboring improvements and surroundings including but not limited to form, spacing, heights, setbacks, materials, color, rhythm and pattern of architectural or aesthetic interest or value as well as with any overlays and other development schemes or legislation.

- vii. In the event of redevelopment, the applicant shall also submit a detailed plan for demolition.

- (b) After the revisions and upon review of the final site plan by the DRG members, the site plan will be scheduled for the next available ~~town design review board and planning and zoning board meetings.~~ If possible, the planning and zoning board meeting and the

~~design review board meeting should be held on the same date. The materials required under subsection 90-19.8 should not be duplicated for both the planning and zoning board meeting and design review board meeting. They shall be considered one submittal package. The Town Manager or designee shall prepare a report to the planning and zoning board and town commission, addressing the applicable criteria.~~

- (3) Submittal requirements for DRG, ~~and~~ planning and zoning board ~~and design review board~~ are provided below.

* * *

~~(4) Developmental impact committee.~~

- ~~(a) There is hereby established a developmental impact committee composed of seven members representing the following town departments and disciplines:~~

- ~~i. Town manager~~
- ~~ii. Town attorney~~
- ~~iii. Public works/landscape~~
- ~~iv. Planning and zoning~~
- ~~v. Park and recreation department~~
- ~~vi. Engineering and traffic engineering~~
- ~~vii. Building~~

- ~~(b) The developmental impact committee shall review all developments (except single family and two family homes) and recommend where applicable, whether, and the extent to which:~~

- ~~i. The development, as proposed, conforms to the comprehensive plan and the zoning code;~~
- ~~ii. The development, as proposed, will have a favorable or unfavorable impact on the environment and natural resources, including a consideration of the means and estimated cost necessary to minimize the adverse impacts, if any;~~
- ~~iii. The development, as proposed, will have a favorable or unfavorable impact on the economy of the Town of Surfside;~~
- ~~iv. The development, as proposed, will efficiently use or unduly burden water, sewer, solid waste disposal, education, recreation or other necessary public facilities which have been constructed or planned and budgeted for construction in the area;~~
- ~~v. The development, as proposed, will efficiently use or unduly burden or affect public transportation facilities, including mass transit, public streets, and roads, which have been planned and budgeted for construction in the area, and if the development is or will be accessible by private or public roads or streets.~~
- ~~vi. The development, as proposed, is consistent with the community character of the immediate neighborhood. In addition to consistency there must be congruity between the subject development and neighboring improvements and surroundings including but not limited to form, spacing, heights, setbacks, materials, color,~~

rhythm and pattern of architectural or aesthetic interest or value as well as with any overlays and other development schemes or legislation.

vii. In the event of redevelopment, applicant shall also submit a detailed plan for demolition.

(e) The committee shall meet prior to the planning and zoning board's hearing on the application. The committee shall be chaired by the town manager. The town manager or designee shall prepare a summary report of the development application to be distributed to and reviewed by the development impact committee prior to the committee meeting.

(d) The town manager or designee shall prepare a summary report of the results of the development impact committee to be transmitted to the planning and zoning board and town commission upon their review of the development application.

(e) The committee shall review and make recommendations pursuant to the criteria stated in (2) to the planning and zoning board and town commission whether, and to the extent to which, the development will efficiently use or unduly burden water, sewer, solid waste disposal, education, recreation or other necessary public facilities or public transportation facilities, including roads and streets, which have been constructed or planned and budgeted for construction in the area, and whether the proposed development will have a favorable or unfavorable impact on the economy of the Town of Surfside.

(f) No public hearing shall be held by any board on any application subject to review by the developmental impact committee until the committee has made its recommendations with regard thereto.

(g) Development impact committee meetings shall be noticed on the town website and shall be open to the public who may comment during a specific time scheduled on the agenda.

* * *

90-20.2 *Exempt development.* Notwithstanding any other provision of this chapter, the following activities shall not require site plan approval, however, may require design review board approval by the planning and zoning board:

- (1) The deposit and contouring of fill on land.
- (2) Construction of a single-family home on an existing single-family lot.
- (3) Construction of a single duplex on an existing single lot.

90-20.3 *Effective period of final site plan approval.* An approved final site plan shall be effective until the development is completed except that if, after 24 months from the date the final site plan is approved by the planning and zoning board a building permit for a principal building has not been issued and remains in effect, the site plan shall be null and void.

- (1) Extensions for good cause, not to exceed a total of one year for all extensions, may be granted by the town commission, at its sole discretion, provided the applicant submits a request in writing to the town manager or designee in advance of the expiration of the original approval, setting forth good cause for such an extension. For the purpose of this

section, a building permit for a principal building shall cease to be in effect once required inspections have lapsed or once a certificate of completion or certificate of occupancy is issued. In those cases where a development includes more than one principal building and it is contemplated that the development shown on a site plan will not be completed with a building permit for a principal building continuously in effect, approval by the planning and zoning board of a phasing schedule must be obtained as part of the overall site plan approval. Amendments to the original site plan shall not extend this time frame unless an extension is expressly granted by the planning and zoning board as a part of the approval of the amendment.

- (2) All approvals which have been granted prior to the effective date of this chapter, shall be null and void and of no further force or effect if not utilized within two years after the effective date of this chapter, unless vested rights are demonstrated pursuant to subsection 90-5(11) of the zoning code. The foregoing provision of this paragraph shall not apply if the governmental ~~resolution granting the~~ approval expressly established a specific time limitation for utilizing the approval. In such instances, the time limitation established by such resolution shall prevail.

* * *

Sec. 90-23. - Conditional uses.

90-23.1 Purpose. Conditional Uses are generally compatible with the other land uses permitted in a zoning district but, because of their unique characteristics or potential impacts on the surrounding neighborhood and the town as a whole, require individual review as to their location, design, configuration, and/or operation for the particular use at the particular location proposed, as well as the imposition of individualized conditions in order to ensure that the use is compatible with the surrounding neighborhoods and appropriate at a particular location.

90-23.2 Standards of review. In addition to the standards set forth in this zoning code for the particular use, all proposed conditional uses shall meet each of the following standards:

- (1) The proposed use shall be consistent with the Comprehensive Plan and the Zoning Code;
- (2) The establishment, maintenance or operation of the proposed use shall not be detrimental to or endanger the public health, safety, or general welfare;
- (3) The proposed use shall be compatible with the community character of the immediate neighborhood. In addition to compatibility there must be congruity between the subject development and neighboring improvements and surroundings including but not limited to form, spacing, heights, setbacks, materials, color, rhythm and pattern of architectural or aesthetic interest or value as well as with any overlays and other development schemes or legislation.
- (4) Adequate provisions shall be included for parking and safe traffic movement, both vehicular and pedestrian, both internal to the use and in the area which will serve the use;
- (5) Adequate measures exist including landscaping or other buffering measures or shall be taken to mitigate any adverse effects of noise, light or other potential nuisances; and

- (6) The establishment of the conditional use shall not impede the development of surrounding properties for uses permitted in the zoning district; and
- (7) Any other condition imposed by the planning and zoning design review board and/or the development impact committee.

* * *

DIVISION 2. - NONCONFORMING USES, LOTS AND STRUCTURES

* * *

Sec. 90-33. - Alterations or enlargement of nonconforming structures.

Except as provided in this section a nonconforming structure shall not be enlarged in any manner or undergo any structural alteration unless to make it a conforming structure. Such alteration or enlargement may be permitted provide that:

- (1) Enlargement or alteration itself conforms to the requirement of these regulations;
- (2) Building non-conformity only as to height area or floor area requirements may be altered or extended; enlarged so long as it does not increase the degree of non-conformity for the applicable district.
- (3) Alterations or additions to architecturally significant buildings on H120 zoned lots that are nonconforming as to setbacks may follow existing building lines as long as the alteration or addition maintains the architectural integrity of the existing building. The lesser of the current code-required setback or the existing building line shall be deemed to be the required setback line.

Any redevelopment project undertaken under this subsection must comply with the Town's minimum finished floor elevation requirements for all portions of the building and further must be designed and developed in accordance with Leadership in Energy & Environmental Design (LEED) or Florida Green Building Coalition (FGBC) building design and construction standards.

Redevelopment projects seeking to utilize the setback exception of this subsection shall be limited to a total height of no more than twice the number of existing floors in a building, up to a maximum of 120 feet.

Existing Building Floors	Maximum Number of Floors of Redevelopment/Expansion using Exception
1	2
2	4
3	6

4	8
5	10
6 and above	12

(a) Determinations of Architectural Significance. Determinations of architectural significance will be made as follows:

- (1) All requests for a determination of architectural significance must be made by a property owner in writing on the forms promulgated by the town. As part of the determination application, a property owner will submit an analysis of the architectural qualities of the existing structure prepared by a licensed architect, at the property owner's expense, demonstrating why the building is consistent with the Code's definition of an architecturally significant building. This analysis shall be accompanied with other materials deemed necessary by the town manager or designee to accommodate the review, including, but not limited to, all available data and documentation regarding the building, site, features, or other considerations by the town manager or designee.
- (2) The town manager or designee will review the analysis prepared by the property owner and issue a recommendation as to whether the building meets the town's standards of architectural significance. The property owner shall be responsible for the town's costs associated with this review, including the fees charged by any necessary consultants, such amounts shall be determined by the town manager or designee and held in escrow by the town.
- (3) Determinations of architectural significance will be made by the planning and zoning design review board, after public hearing, based on the following requirements.

* * *

(b) Alterations to Architecturally Significant Buildings. Any alteration proposed for a building on H120 zoned lots determined by the planning and zoning design review board to be architecturally significant will be reviewed by the Town Manager or his designee and the planning and zoning design review board to determine whether:

- i. The proposed alteration or addition does not require demolition or alteration in a manner that would render the building no longer architecturally significant; and
- ii. The proposed alteration or addition is designed in a manner that is compatible with the existing building.

(c) Site Plan Review for Architecturally Significant Buildings. Any addition requiring a site plan that is proposed for a building determined by the planning and zoning

design review board to be architecturally significant will be reviewed by the town manager or designee, ~~the design review board~~, the planning and zoning board, and the town commission to determine whether:

- i. The proposed alteration or addition does not require demolition or alteration in a manner that would render the building no longer architecturally significant; and
- ii. The proposed alteration or addition is designed in a manner that is compatible with the existing building.

Sec. 90-34. - Nonconforming uses not validated.

A nonconforming use in violation of a provision of these regulations, or any provision which these regulations amend or replace shall not be validated by the adoption of these regulations.

* * *

Sec. 90-49.2. - Awnings and canopies.

The following Design Criteria are applicable to all multi-dwelling and non-residential properties. All new and replacement awnings and canopies shall meet these requirements.

a. *Location/placement.*

* * *

b. *Appearance.*

1. Awnings shall be fabric or metal. Plastic and vinyl awnings are prohibited, except for First Grade vinyl awnings, subject to design review approval by the planning and zoning design review board.
2. Awnings shall be solid colors rather than patterned.
3. If an awning valance is proposed, it shall be straight rather than curved, except for special architectural elements to be compatible with historic building styles.
4. Awning colors shall enhance and complement the building and adjacent awnings, rather than overwhelm the building scheme. Colors shall not call more attention to the awning than the building.
5. Lighting associated with awnings and canopies shall be prohibited, except lighting approved by the planning and zoning design review board which is attached underneath the awning and intended to provide pedestrian lighting.
6. Signage, graphics and lettering shall be prohibited on canopies and awnings.

* * *

Sec. 90-50. - Architecture and roof decks.

90-50.1 Architecture.

- (1) Elevation and facade articulation variations.

- a. The architectural design of proposed main buildings shall create a unique elevation compared to the main buildings of the adjacent two buildings on each side of the subject property on the same side of street. If the adjacent lot is vacant then the next adjacent lot shall be utilized. A unique elevation shall be created through the modulation of at least three of the following architectural features:
 1. Length, width and massing of the structure;
 2. Number of stories;
 3. Facade materials;
 4. Porches and other similar articulation of the front facade;
 5. Number and location of doors and windows; and
 6. Roof style and pitch.
- (2) In the H30C, H40 and H120 districts: when more than one building is provided, buildings shall be designed in such a way that they are not monotonous.
- (3) All elevations for new structures and multi-story additions (additions greater than 15 feet in height) shall provide for a minimum of ten-percent wall openings including windows, doors or transitional spaces defined by porches, porticoes or colonnades per story.
- (4) All elevations for single story additions to existing structures shall result in a zero percent net loss of wall openings including windows, doors or transitional spaces defined by porches, porticoes or colonnades.
- (5) Roof materials are limited as follows:
 - a. Clay tile; or
 - b. White concrete tile; or
 - c. Solid color cement tile which color is impregnated with the same color intensity throughout, provided said color is granted design review approval by the planning and zoning design review board;
 - d. Architecturally embellished metal; or
 - e. Other Florida Building Code approved roof material(s) if granted design review approval by the planning and zoning design review board.
- (6) Garage facades. Attached garages located at the front of a single family home shall not exceed 50 percent of the overall length of the facade.
- (7) Converting single-family attached garages. When an attached garage is converted for any other use, the garage door or doors may be replaced by a solid exterior wall and access to the former garage area must be provided from the main premises, in addition to any other permitted access. At least one window shall be provided. If the garage entrance is located at the front or primary corner of the property, landscaping shall be provided along the base of the new exterior wall. When the installation of landscaping results in insufficient off-street parking, a landscaped planter shall be permitted in lieu of the required landscaping. It is intended hereby to prohibit and prevent any violation

of the single-family classification and to minimize the burden upon the administrative forces of the town in policing and enforcing the provisions hereof. Changes to the appearance of the residence shall not constitute a change prohibited by the "home office" provision of this Code. If the exterior door of the garage conversion is no longer level with grade, stairs may be installed and the exterior door must be accordingly corrected to comply with the Florida Building Code. The stairs shall be permitted to encroach no more than 24 inches into the side or rear setbacks.

- (8) Notwithstanding the foregoing, some of the architecture provisions in this section, while specific to zoning districts H30A and H30B, may also be applicable to single family homes in other zoning districts.
- (9) Paint colors. Structures in the H30A and H30B zoning districts shall be permitted to be painted the four lightest colors for the structure's primary color on the color swatch on file in the building department. All other colors may be accent colors. A paint swatch shall be submitted to the building department for approval by the town manager or designee. The planning and zoning design review board shall make a design determination in cases of uncertainty.

* * *

Sec. 90-54. - Accessory buildings and structures in the H30A and H30B districts.

* * *

90-54.8 All accessory buildings and structures, swimming pools, and accompanying fences and landscaping, located in the front yard setback shall be subject to review by the planning and zoning design review board.

* * *

Sec. 90-56. - Fences, walls and hedges.

* * *

90-56.2 A fence or ornamental wall may be placed within the front yard or primary corner yard if granted design review approval by the planning and zoning design review board.

* * *

90-56.9 Hedges shall be no more than four feet in height in the front yard and side corner yards and ten feet in height in the rear and interior side yards. Hedges may be higher if granted design review approval by the planning and zoning design review board, on a case-by-case basis.

* * *

Section 3. Severability. If any section, subsection, clause or provision of this Ordinance is declared invalid or unconstitutional by a court of competent jurisdiction, the remainder shall not be affected by such invalidity.

Section 4. Conflict. All sections or parts of sections of the Town of Surfside Code of Ordinances in conflict herewith are intended to be repealed to the extent of such conflict.

Section 5. Inclusion in the Code of Ordinances. It is the intention of the Town Commission, and it is hereby ordained that the provisions of this Ordinance shall become and made a part of the Town of Surfside Code of Ordinances, that the sections of this Ordinance may be renumbered or re-lettered to accomplish such intentions; and the word "Ordinance" may be changed to "Section" or other appropriate word.

Section 6. Effective Date. This Ordinance shall be effective upon final adoption on second reading.

PASSED on first reading this 14th day of August, 2018.

PASSED and **ADOPTED** on second reading this 12th day of September, 2018.

On Final Reading Moved by: Vice Mayor Gielchinsky

On Final Reading Second by: Commissioner Cohen

FINAL VOTE ON ADOPTION

Commissioner Barry Cohen	<u>yes</u>
Commissioner Michael Karukin	<u>NO</u>
Commissioner Tina Paul	<u>yes</u>
Vice Mayor Daniel Gielchinsky	<u>yes</u>
Mayor Daniel Dietch	<u>yes</u>



Daniel Dietch, Mayor

ATTEST:



Sandra Novoa, MMC, Town Clerk

**APPROVED AS TO FORM AND LEGALITY FOR THE USE
AND BENEFIT OF THE TOWN OF SURFSIDE ONLY:**

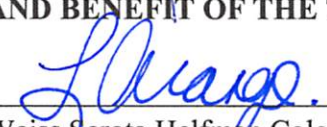

Weiss Serota Helfman Cole & Bierman, P.L.,
Town Attorney



MEMORANDUM

ITEM NO. 9V

To: Honorable Mayor, Vice-Mayor and Members of the Town Commission
From: Guillermo Olmedillo, Town Manager
Date: April 16, 2020
Subject: Weiss Serota Contract Follow up

At the March 24, 2020 Special Commission Meeting, Town Administration was directed to provide a report on the expenditures related to the Weiss Serota Town Attorney contract for the period of January 2019 through December 2019.

Please find attached requested report. Th report was provided to Commission on April 7, 2020.

Reviewed by: LA

Prepared by: JDG



Town of Surfside, Florida

My Vendor History Report

Posting Date Range 01/01/2019 - 12/31/2019

By Vendor Name

1067 - WEISS SEROTA HELFMAN COLE

Payment Date Range -

Payable Number	Description	Units	Price	Post Date	1099 Account Number	Payment Number	Account Name	Amount	Shipping Dist Amount	Tax	Discount	Net	Payment
12345	SEP-19 PARTICIPATION OF COAL OF CITIES F19/30/2019	0.00	0.00	1,923.08	001-1500-514-31-10	112423	1/22/2020	1,923.08	0.00	0.00	0.00	485,923.86	485,923.86
212256	LEGAL FEES DECEMBER 2018 12/1/2018-12/31/28/2019	0.00	0.00	2,596.52	001-1500-514-31-10	109435	2/22/2019	2,596.52	0.00	0.00	0.00	2,596.52	2,596.52
212257	LEGAL FEES DECEMBER 2018 12/1/2018-12/31/28/2019	0.00	0.00	29,653.84	001-1500-514-31-10	109435	2/22/2019	29,653.84	0.00	0.00	0.00	29,653.84	29,653.84
212258	LEGAL DECEMBER 12/1/18-12/31/2018	0.00	0.00	125.00	001-220-90-10	109435	2/22/2019	125.00	0.00	0.00	0.00	125.00	125.00
212259	LEGAL FEES DECEMBER 12/1/2018-12/31/201/28/2019	0.00	0.00	125.00	001-220-90-10	109435	2/22/2019	125.00	0.00	0.00	0.00	125.00	125.00
212260	LEGAL FEES DECEMBER 2018 12/1/2018-12/31/28/2019	0.00	0.00	6,267.29	001-1500-514-31-10	109435	2/22/2019	6,267.29	0.00	0.00	0.00	6,267.29	6,267.29
212261	LEGAL FEES DECEMBER 12/1/2018-12/31/201/28/2019	0.00	0.00	482.50	001-1500-514-31-10	109435	2/22/2019	482.50	0.00	0.00	0.00	482.50	482.50
213421	LEGAL FEES FOR JANUARY 2019	0.00	0.00	858.00	001-1500-514-31-10	109833	4/8/2019	858.00	0.00	0.00	0.00	858.00	858.00
213422	LEGAL FEES FOR JANUARY 2019	0.00	0.00	1,225.00	001-1500-514-31-10	109833	4/8/2019	1,225.00	0.00	0.00	0.00	1,225.00	1,225.00
213423	LEGAL FEES JANUARY 2019	0.00	0.00	29,660.22	001-1500-514-31-10	109833	4/8/2019	29,660.22	0.00	0.00	0.00	29,660.22	29,660.22
213424	LEGAL FEES FOR JANUARY 2019	0.00	0.00	125.00	001-220-90-10	109833	4/8/2019	125.00	0.00	0.00	0.00	125.00	125.00
213425	LEGAL FEES FOR JANUARY 2019	0.00	0.00	1,533.00	001-1500-514-31-10	109833	4/8/2019	1,533.00	0.00	0.00	0.00	1,533.00	1,533.00
213426	LEGAL FEES FOR JANUARY 2019	0.00	0.00	250.00	001-220-90-10	109833	4/8/2019	250.00	0.00	0.00	0.00	250.00	250.00
213427	LEGAL FEES FOR JANUARY 2019	0.00	0.00	1,625.00	001-1500-514-31-10	109833	4/8/2019	1,625.00	0.00	0.00	0.00	1,625.00	1,625.00
213905	LEGAL FEES FEBRUARY 2019	0.00	0.00	2,273.50	001-1500-514-31-10	109833	4/8/2019	2,273.50	0.00	0.00	0.00	2,273.50	2,273.50

My Vendor History Report

Posting Date Range 01/01/2019 - 12/31/2019

Payable Number	Description	Units	Price	Amount	Post Date	1099 Account Number	Payment Number	Account Name	Payment Date	Amount	Shipping Dist Amount	Tax	Discount	Net	Payment
2113906	LEGAL FEES FEBRUARY 2019	0.00	0.00	50.00	3/18/2019	Y 109833		PROFESSIONAL SERVICES	4/8/2019	50.00	0.00	0.00	0.00	50.00	50.00
2113908	LEGAL FEES FOR FEBRUARY 2019	0.00	0.00	29,655.06	3/18/2019	Y 109833		PROFESSIONAL SERVICES	4/8/2019	29,655.06	29,655.06	0.00	0.00	29,655.06	29,655.06
2113909	LEGAL FEES FEBRUARY 2019	0.00	0.00	6,200.00	3/18/2019	Y 109833		COST RECOVERY	4/8/2019	6,200.00	6,200.00	0.00	0.00	6,200.00	6,200.00
2113910	LEGAL FEES FEBRUARY 2019	0.00	0.00	383.00	3/18/2019	Y 109833		PROFESSIONAL SERVICES	4/8/2019	383.00	383.00	0.00	0.00	383.00	383.00
2113911	LEGAL FEES FEBRUARY 2019	0.00	0.00	4,175.00	3/18/2019	Y 109833		PROFESSIONAL SERVICES	4/8/2019	4,175.00	4,175.00	0.00	0.00	4,175.00	4,175.00
215204	LEGAL FEES FOR FEB. 2019 /PERIOD 3/01/19-4/16/2019	0.00	0.00	913.70	3/1/19-3/4/16/2019	Y 110114		PROFESSIONAL SERVICES	5/6/2019	913.70	913.70	0.00	0.00	913.70	913.70
215205	LEGAL FEES FOR FEB 2019/PERIOD 3/1/19-3/4/16/2019	0.00	0.00	2,395.65	3/1/19-3/4/16/2019	Y 110114		PROFESSIONAL SERVICES	5/6/2019	2,395.65	2,395.65	0.00	0.00	2,395.65	2,395.65
215206	LEGAL FEES FOR FEB 2019/PERIOD 3/1/19-3/4/16/2019	0.00	0.00	29,656.30	3/1/19-3/4/16/2019	Y 110114		PROFESSIONAL SERVICES	5/6/2019	29,656.30	29,656.30	0.00	0.00	29,656.30	29,656.30
215207	LEGAL FEES FOR FEB 2019/PERIOD 3/1/19-3/4/16/2019	0.00	0.00	475.00	3/1/19-3/4/16/2019	Y 110114		COST RECOVERY	5/6/2019	475.00	475.00	0.00	0.00	475.00	475.00
215208	LEGAL FEES FOR FEB 2019/PERIOD 3/1/19-3/4/16/2019	0.00	0.00	1,300.00	3/1/19-3/4/16/2019	Y 110114		COST RECOVERY	5/6/2019	1,300.00	1,300.00	0.00	0.00	1,300.00	1,300.00
215209	LEGAL FEES FOR FEB 2019/PERIOD 3/1/19-3/4/16/2019	0.00	0.00	3,909.00	3/1/19-3/4/16/2019	Y 110114		PROFESSIONAL SERVICES	5/6/2019	3,909.00	3,909.00	0.00	0.00	3,909.00	3,909.00
215210	LEGAL FEES FOR FEB 2019/PERIOD 3/1/19-3/4/16/2019	0.00	0.00	297.00	3/1/19-3/4/16/2019	Y 110114		PROFESSIONAL SERVICES	5/6/2019	297.00	297.00	0.00	0.00	297.00	297.00
215211	LEGAL FEES FOR FEB 2019/PERIOD 3/1/19-3/4/16/2019	0.00	0.00	375.00	3/1/19-3/4/16/2019	Y 110114		PROFESSIONAL SERVICES	5/6/2019	375.00	375.00	0.00	0.00	375.00	375.00
216027	LEGAL FEES APRIL 1-30, 2019	0.00	0.00	3,736.50	5/14/2019	Y 110380		PROFESSIONAL SERVICES	6/4/2019	3,736.50	3,736.50	0.00	0.00	3,736.50	3,736.50
216028	LEGAL FEES APRIL 1-30, 2019	0.00	0.00	1,311.50	5/14/2019	Y 110380		PROFESSIONAL SERVICES	6/4/2019	1,311.50	1,311.50	0.00	0.00	1,311.50	1,311.50
216029	LEGAL FEES APRIL 1-30, 2019	0.00	0.00	29,615.66	5/14/2019	Y 110380		PROFESSIONAL SERVICES	6/4/2019	29,615.66	29,615.66	0.00	0.00	29,615.66	29,615.66
216030	LEGAL FEES APRIL 1-30, 2019	0.00	0.00	1,075.00	5/14/2019	Y 110380		COST RECOVERY	6/4/2019	1,075.00	1,075.00	0.00	0.00	1,075.00	1,075.00
216031	LEGAL FEES APRIL 1-30, 2019	0.00	0.00	1,200.00	5/14/2019	Y 110380		COST RECOVERY	6/4/2019	1,200.00	1,200.00	0.00	0.00	1,200.00	1,200.00
216032	LEGAL FEES APRIL 1-30, 2019	0.00	0.00	925.00	5/14/2019	Y 110380		COST RECOVERY	6/4/2019	925.00	925.00	0.00	0.00	925.00	925.00

My Vendor History Report

Posting Date Range 01/01/2019 - 12/31/2019

Payable Number	Description	Units	Price	Amount	Post Date	1099 Account Number	Payment Number	Account Name	Payment Date	Amount	Shipping Dist Amount	Tax	Discount	Net	Payment
217140	LEGAL FEES APRIL 1-30, 2	0.00	0.00	925.00	5/14/2019	001-1500-514-31-10	110380	PROFESSIONAL SERVICES	6/4/2019	7,014.47	925.00	0.00	0.00	7,014.47	7,014.47
217141	LEGAL FEES APRIL 1-30, 2	0.00	0.00	5,948.00	6/19/2019	001-1500-514-31-10	110844	PROFESSIONAL SERVICES	7/26/2019	4,207.72	5,948.00	0.00	0.00	4,207.72	4,207.72
217142	LEGAL FEES APRIL 1-30, 2	0.00	0.00	1,066.47	6/19/2019	001-1500-514-31-10	110844	PROFESSIONAL SERVICES	7/26/2019	2,250.00	1,066.47	0.00	0.00	2,250.00	2,250.00
217143	LEGAL FEES APRIL 1-30, 2	0.00	0.00	5,948.00	6/19/2019	001-1500-514-31-10	110380	PROFESSIONAL SERVICES	6/4/2019	575.00	5,948.00	0.00	0.00	575.00	575.00
217144	LEGAL FEES APRIL 1-30, 2	0.00	0.00	575.00	5/14/2019	001-1500-514-31-10	110380	PROFESSIONAL SERVICES	6/4/2019	575.00	575.00	0.00	0.00	575.00	575.00
217145	LEGAL FEES FOR MAY 201	0.00	0.00	50.00	6/19/2019	001-1500-514-31-10	110844	PROFESSIONAL SERVICES	7/26/2019	50.00	50.00	0.00	0.00	50.00	50.00
217146	LEGAL FEES FOR MAY 201	0.00	0.00	4,207.72	6/19/2019	001-1500-514-31-10	110844	PROFESSIONAL SERVICES	7/26/2019	4,207.72	4,207.72	0.00	0.00	4,207.72	4,207.72
217147	LEGAL FEES FOR MAY 201	0.00	0.00	2,250.00	6/19/2019	001-1500-514-31-10	110844	PROFESSIONAL SERVICES	7/26/2019	2,250.00	2,250.00	0.00	0.00	2,250.00	2,250.00
217148	LEGAL FEES FOR MAY 201	0.00	0.00	12.00	6/19/2019	001-1500-514-31-10	110844	PROFESSIONAL SERVICES	7/26/2019	12.00	12.00	0.00	0.00	12.00	12.00
217149	LEGAL FEES FOR MAY 201	0.00	0.00	29,612.50	6/19/2019	001-1500-514-31-10	110844	PROFESSIONAL SERVICES	7/26/2019	29,612.50	29,612.50	0.00	0.00	29,612.50	29,612.50
217150	LEGAL FEES FOR MAY 201	0.00	0.00	1,675.00	6/19/2019	001-220-90-10	111192	COST RECOVERY	7/26/2019	1,675.00	1,675.00	0.00	0.00	1,675.00	1,675.00
217151	LEGAL FEES FOR MAY 201	0.00	0.00	1,145.50	6/19/2019	001-1500-514-31-10	110844	PROFESSIONAL SERVICES	7/26/2019	1,145.50	1,145.50	0.00	0.00	1,145.50	1,145.50
217152	LEGAL FEES FOR MAY 201	0.00	0.00	575.00	6/19/2019	001-1500-514-31-10	110844	PROFESSIONAL SERVICES	7/26/2019	575.00	575.00	0.00	0.00	575.00	575.00
217153	LEGAL FEES FOR JUNE 20	0.00	0.00	221.30	6/30/20	001-1500-514-31-10	111192	PROFESSIONAL SERVICES	9/6/2019	221.30	221.30	0.00	0.00	221.30	221.30
217154	LEGAL FEES FOR JUNE 20	0.00	0.00	272.00	6/30/20	001-1500-514-31-10	111192	PROFESSIONAL SERVICES	9/6/2019	272.00	272.00	0.00	0.00	272.00	272.00
217155	LEGAL FEES FOR JUNE 20	0.00	0.00	1,000.00	6/30/20	001-1500-514-31-10	111192	PROFESSIONAL SERVICES	9/6/2019	1,000.00	1,000.00	0.00	0.00	1,000.00	1,000.00
217156	LEGAL FEES FOR JUNE 20	0.00	0.00	29,612.50	6/1/19 - 6/30/20	001-1500-514-31-10	111192	PROFESSIONAL SERVICES	9/6/2019	29,612.50	29,612.50	0.00	0.00	29,612.50	29,612.50
217157	LEGAL FEES FOR JUNE 20	0.00	0.00	375.00	6/1/19 - 6/30/20	001-220-90-10	111192	COST RECOVERY	9/6/2019	375.00	375.00	0.00	0.00	375.00	375.00
217158	LEGAL FEES FOR JUNE 20	0.00	0.00	750.50	6/1/19 - 6/30/20	001-1500-514-31-10	111192	PROFESSIONAL SERVICES	9/6/2019	750.50	750.50	0.00	0.00	750.50	750.50
217159	LEGAL FEES FOR JUNE 20	0.00	0.00	575.00	6/1/19 - 6/30/20	001-1500-514-31-10	111192	PROFESSIONAL SERVICES	9/6/2019	575.00	575.00	0.00	0.00	575.00	575.00
217160	LEGAL FEES FOR JUNE 20	0.00	0.00	840.00	6/1/19 - 6/30/20	001-1500-514-31-10	111192	PROFESSIONAL SERVICES	9/6/2019	840.00	840.00	0.00	0.00	840.00	840.00

My Vendor History Report

Posting Date Range 01/01/2019 - 12/31/2019

Payable Number	Description	Units	Price	Amount	Post Date	1099 Account Number	Payment Number	Account Name	Payment Date	Amount	Shipping Dist Amount	Tax	Discount	Net	Payment
219594	LEGAL FEES FOR JUNE 2019	0.00	0.00	840.00	8/29/2019	001-1500-514-31-10		PROFESSIONAL SERVICES	9/19/2019	1,057.90	0.00	0.00	0.00	1,057.90	1,057.90
219595	GENERAL LABOR 07/2019	0.00	0.00	1,057.90	8/29/2019	001-1500-514-31-10		PROFESSIONAL SERVICES	9/19/2019	1,057.90	0.00	0.00	0.00	1,057.90	1,057.90
219596	POLICE MATTERS 07/2019	0.00	0.00	129.00	8/29/2019	001-1500-514-31-10		PROFESSIONAL SERVICES	9/19/2019	129.00	0.00	0.00	0.00	129.00	129.00
219597	MONTHLY RETAINER 7/2019	0.00	0.00	29,634.00	8/29/2019	001-1500-514-31-10		PROFESSIONAL SERVICES	9/19/2019	29,634.00	0.00	0.00	0.00	29,634.00	29,634.00
219598	LAND USE RECOVER - EDEN	0.00	0.00	450.00	8/29/2019	001-220-90-10		COST RECOVERY	9/19/2019	450.00	0.00	0.00	0.00	450.00	450.00
219599	LEGAL FEE FOR JULY 2019 PERIOD 7/1/2019-8/29/2019	0.00	0.00	4,266.50	8/29/2019	001-1500-514-31-10		PROFESSIONAL SERVICES	9/19/2019	4,266.50	0.00	0.00	0.00	4,266.50	4,266.50
219600	SUSTAINABILITY & RESILIENCY COMMITTEE 7/2019	0.00	0.00	537.50	8/29/2019	001-1500-514-31-10		PROFESSIONAL SERVICES	9/19/2019	537.50	0.00	0.00	0.00	537.50	537.50
219601	SURF CLUB 7/2019	0.00	0.00	200.00	8/29/2019	001-1500-514-31-10		PROFESSIONAL SERVICES	9/19/2019	200.00	0.00	0.00	0.00	200.00	200.00
219879	POLICE MATTERS 7/2019	0.00	0.00	3,436.00	9/12/2019	001-1500-514-31-10		PROFESSIONAL SERVICES	9/30/2019	3,436.00	0.00	0.00	0.00	3,436.00	3,436.00
220398	PROFESSIONAL SERVICES RENDERED AUG-19 9/17/2019	0.00	0.00	2,986.20	9/17/2019	001-1500-514-31-10		PROFESSIONAL SERVICES	9/30/2019	2,986.20	0.00	0.00	0.00	2,986.20	2,986.20
220399	POLICE MATTERS AUG-19	0.00	0.00	228.60	9/17/2019	001-1500-514-31-10		PROFESSIONAL SERVICES	9/30/2019	228.60	0.00	0.00	0.00	228.60	228.60
220400	PROFESSIONAL SERVICES FOR CODE ENFORC/9/17/2019	0.00	0.00	1,182.50	9/17/2019	001-1500-514-31-10		PROFESSIONAL SERVICES	9/30/2019	1,182.50	0.00	0.00	0.00	1,182.50	1,182.50
220401	MONTHLY RETAINER FOR LEGAL SERVICES AL 9/17/2019	0.00	0.00	29,770.12	9/17/2019	001-1500-514-31-10		PROFESSIONAL SERVICES	9/30/2019	29,770.12	0.00	0.00	0.00	29,770.12	29,770.12
220402	LAND USE COST REC. YOUNG ISRAEL-ADA RAM 9/30/2019	0.00	0.00	3,700.00	9/30/2019	001-220-90-10		COST RECOVERY	9/30/2019	3,700.00	0.00	0.00	0.00	3,700.00	3,700.00
220403	LAND USE COST RECOVER. KRIEG, DAVID & BELLA 9/17/2019	0.00	0.00	930.00	9/17/2019	001-220-90-10		COST RECOVERY	9/30/2019	930.00	0.00	0.00	0.00	930.00	930.00
220404	LAND USE COST RECOVER. EDEN SURFSIDE AUG 9/17/2019	0.00	0.00	250.00	9/17/2019	001-220-90-10		COST RECOVERY	9/30/2019	250.00	0.00	0.00	0.00	250.00	250.00
220405	SPECIAL PROJECTS	0.00	0.00	450.00	9/17/2019	001-1500-514-31-10		PROFESSIONAL SERVICES	9/30/2019	450.00	0.00	0.00	0.00	450.00	450.00
220406	LITIGATION	0.00	0.00	3,276.00	9/17/2019	001-1500-514-31-10		PROFESSIONAL SERVICES	9/30/2019	3,276.00	0.00	0.00	0.00	3,276.00	3,276.00
220407	SOLIMAR COND-CHALLENGE UTI. FEES LITIG 9/17/2019	0.00	0.00	5,640.00	9/17/2019	001-1500-514-31-10		PROFESSIONAL SERVICES	9/30/2019	5,640.00	0.00	0.00	0.00	5,640.00	5,640.00

My Vendor History Report

Posting Date Range 01/01/2019 - 12/31/2019

Payable Number	Description	Units	Price	Amount	Post Date	1099 Account Number	Payment Number	Account Name	Payment Date	Amount	Shipping Dist Amount	Tax	Discount	Net	Payment
2220408	PREPARATION OF RESPONSE TO AUDIT LETTE	0.00	250.00	250.00	9/30/2019	001-1500-514-31-10	Y 111432	PROFESSIONAL SERVICES	9/30/2019	250.00	0.00	0.00	0.00	250.00	250.00
221976	SEPT-19 PROFESSIONAL SERVICES	0.00	2,043.50	2,043.50	9/30/2019	001-1500-514-31-10	Y 112048	PROFESSIONAL SERVICES	12/9/2019	2,043.50	0.00	0.00	0.00	2,043.50	2,043.50
221977	SEP-19 POLICE MATTERS	0.00	4,601.25	4,601.25	9/30/2019	001-1500-514-31-10	Y 112048	PROFESSIONAL SERVICES	12/9/2019	4,601.25	0.00	0.00	0.00	4,601.25	4,601.25
221978	SEPT-19 MONTHLY RETAINER	0.00	29,676.58	29,676.58	9/30/2019	001-1500-514-31-10	Y 112048	PROFESSIONAL SERVICES	12/9/2019	29,676.58	0.00	0.00	0.00	29,676.58	29,676.58
221979	SEPT-19 COST RECOVERY 8995 COLLINS AVE.	0.00	430.00	430.00	9/30/2019	001-220-90-10	Y 112048	COST RECOVERY	12/9/2019	430.00	0.00	0.00	0.00	430.00	430.00
221980	SEPT-19 COST RECOVERY 9300-9380 COLLINS	0.00	1,000.00	1,000.00	9/30/2019	001-220-90-10	Y 112048	COST RECOVERY	12/9/2019	1,000.00	0.00	0.00	0.00	1,000.00	1,000.00
221981	SEPT-19 LITIGATION	0.00	939.50	939.50	9/30/2019	001-1500-514-31-10	Y 112048	PROFESSIONAL SERVICES	12/9/2019	939.50	0.00	0.00	0.00	939.50	939.50
221982	SEPT-19 SOLIMAR CONDO STORMWATER FEE	0.00	150.00	150.00	9/30/2019	001-1500-514-31-10	Y 112048	PROFESSIONAL SERVICES	12/9/2019	150.00	0.00	0.00	0.00	150.00	150.00
222955	OCT-19 PROFESSIONAL SERVICES	0.00	3,086.50	3,086.50	12/5/2019	001-1500-514-31-10	Y 112127	PROFESSIONAL SERVICES	12/18/2019	3,086.50	0.00	0.00	0.00	3,086.50	3,086.50
222956	OCT-19 POLICE MATTERS	0.00	135.95	135.95	12/5/2019	001-1500-514-31-10	Y 112127	PROFESSIONAL SERVICES	12/18/2019	135.95	0.00	0.00	0.00	135.95	135.95
222957	OCT-19 MONTHLY RETAINER	0.00	29,702.95	29,702.95	12/5/2019	001-1500-514-31-10	Y 112127	PROFESSIONAL SERVICES	12/18/2019	29,702.95	0.00	0.00	0.00	29,702.95	29,702.95
222958	OCT-19 LAND USE COST RECOV. YOUNG ISR	0.00	1,525.00	1,525.00	12/5/2019	001-220-90-10	Y 112127	COST RECOVERY	12/18/2019	1,525.00	0.00	0.00	0.00	1,525.00	1,525.00
222959	OCT-19 LAND USE RECOVERY KRIGER, VARIA	0.00	850.00	850.00	12/5/2019	001-220-90-10	Y 112127	COST RECOVERY	12/18/2019	850.00	0.00	0.00	0.00	850.00	850.00
222960	OCT-19 LAND USE COST RECOV. SAMUEL FR	0.00	675.00	675.00	12/5/2019	001-220-90-10	Y 112127	COST RECOVERY	12/18/2019	675.00	0.00	0.00	0.00	675.00	675.00
222961	OCT-19 LAND USE COST RECOV. 8995 COLLIN	0.00	450.00	450.00	12/13/2019	001-220-90-10	Y 112127	COST RECOVERY	12/18/2019	450.00	0.00	0.00	0.00	450.00	450.00
222962	OCT-19 PROFESSIONAL SERVICES LITIGATION	0.00	2,529.50	2,529.50	12/5/2019	001-1500-514-31-10	Y 112127	PROFESSIONAL SERVICES	12/18/2019	2,529.50	0.00	0.00	0.00	2,529.50	2,529.50
222963	OCT-19 SPECIAL LITIGATION SOLIMAR CONDO	0.00	7,650.50	7,650.50	12/5/2019	001-1500-514-31-10	Y 112127	PROFESSIONAL SERVICES	12/18/2019	7,650.50	0.00	0.00	0.00	7,650.50	7,650.50
223550	NOV-19 PROFESSIONAL SERVICES	0.00	1,604.00	1,604.00	12/12/2019	001-1500-514-31-10	Y 112198	PROFESSIONAL SERVICES	12/23/2019	1,604.00	0.00	0.00	0.00	1,604.00	1,604.00
223551	NOV-19 POLICE MATTERS	0.00	1,934.50	1,934.50	12/12/2019	001-1500-514-31-10	Y 112198	PROFESSIONAL SERVICES	12/23/2019	1,934.50	0.00	0.00	0.00	1,934.50	1,934.50

My Vendor History Report

Posting Date Range 01/01/2019 - 12/31/2019

Payable Number	Description	Units	Price	Amount	Post Date	1099 Account Number	Payment Number	Account Name	Payment Date	Amount	Shipping	Tax	Discount	Net	Payment
NOV-19 POLICE MATTERS		0.00	0.00	1,934.50	12/12/2019	001-1500-514-31-10		PROFESSIONAL SERVICES	12/23/2019	1,934.50	0.00	0.00	0.00	29,612.50	29,612.50
NOV-19 MONTHLY RETAINER		0.00	0.00	29,612.50	12/12/2019	001-1500-514-31-10		PROFESSIONAL SERVICES	12/23/2019	29,612.50	0.00	0.00	0.00	29,612.50	29,612.50
NOV-19 PROFFESIONAL S		0.00	0.00	725.00	12/12/2019	001-1500-514-31-10		PROFESSIONAL SERVICES	12/23/2019	725.00	0.00	0.00	0.00	725.00	725.00
DEC-19 SPECIAL LITIGATION SOLIMAR UTILIT		0.00	0.00	1,042.50	12/12/2019	001-1500-514-31-10		PROFESSIONAL SERVICES	12/23/2019	1,042.50	0.00	0.00	0.00	1,042.50	1,042.50
DEC-19 SPECIAL LITIGATC		0.00	0.00	1,042.50	12/12/2019	001-1500-514-31-10		PROFESSIONAL SERVICES	12/23/2019	1,042.50	0.00	0.00	0.00	1,042.50	1,042.50
INV213906	LEGAL FEES FEBRUARY 2019	0.00	0.00	50.00	3/18/2019	001-1500-514-31-10		PROFESSIONAL SERVICES	4/8/2019	50.00	0.00	0.00	0.00	50.00	50.00
LEGAL FEES FEBRUARY 2C		0.00	0.00	50.00	3/18/2019	001-1500-514-31-10		PROFESSIONAL SERVICES	4/8/2019	50.00	0.00	0.00	0.00	50.00	50.00
Vendors: (1) Total 01 - Vendor Set 01:										485,923.86	0.00	0.00	0.00	485,923.86	485,923.86
Vendors: (1) Report Total:										485,923.86	0.00	0.00	0.00	485,923.86	485,923.86



MEMORANDUM

To: Honorable Mayor, Vice-Mayor and Members of the Town Commission

From: Guillermo Olmedillo, Town Manager

Date: April 15, 2020

Subject: Town Pension Benefits for Non-Public Safety Employees

Pursuant to the April 16, 2020 Town Commission agenda item regarding the Town pension benefits for non-public safety employees, enacted changes are as follows:

On September 13, 2016 the Town Commission approved pension amendments for general employees (non-sworn) that increased the employee contributions and improved benefits effective October 1, 2016 as follows:

- **Increased general employee contribution by 2%.**
General employee contribution increased from 6% to 8%; one grandfathered employee 5% to 7%;
- **Increased the benefit cap from 60% to 68%.**
The benefit cap at 60% was one of the lowest in the State of Florida amongst defined benefit plans.
The benefit cap for police officers (sworn group) is 90%;
- **Increased the multiplier from 2 % to 2.65% for the one grandfathered employee and from 2.5% to 2.8% for all other general employees (non-sworn).**
The multiplier for police officers (sworn group) is 3.5%;
- **A senior management class be established** consistent of all Department Directors and Assistant Town Manager.
Excluded from this class is the Police Chief, Town Manager and Town Attorney (if employed by the Town);
- **The senior management's multiplier increased from 2.5% to 3%** (rather than the 2.8% as other general employees);

- **The senior management cap increased to 80%** (rather than the 68%); and
- **The Town Attorney vesting requirements were lowered** from 10 years to 7 years to match the vesting requirements of the Town Manager.

An actuarial study was conducted. The above changes were cost neutral. The incremental cost to the Town's annual contribution would increase by \$905 or 0% of payroll, the employees covered the cost with the 2% increase of their contributions and the \$905 was primarily the cost to cover the Town Attorney changes.

Please see below table taken from Actuarial Impact Statement, dated September 6, 2016.

	Incremental Cost in Net Town Annual Required Contribution	Incremental Cost in Employee Annual Contribution
Proposed Amendment for General Employees	(\$4,828) (0.2%) of payroll	\$43,050 1.4% of payroll
Proposed Amendment for Senior Management Employees	\$4,483 0.1% of payroll	\$19,376 0.6% of payroll
Proposed Amendment for Town Attorney	\$1,250 0% of payroll	\$0 0% of payroll
Combined Effect	\$905 0% of payroll	\$62,426 2% of payroll

On December 10, 2019 the Town Commission approved pension amendments for General Employees (non-sworn) to conform maximum benefit limitations and retirement ages. Effective January 1, 2020 the plan changes are as follows:

- **Increased the benefit cap for general employees (non-sworn) from 68% to 80%**
- **Lowered retirement age** from age 62 and 15 years of service or age 65 and 10 years of service to:
 - ✚ Age 50 and 20 years of service, or
 - ✚ Age 52 and 15 years of service, or
 - ✚ Age 55 and 10 years of service
- **Increased Cost-of-Living Adjustment (COLA) from 1.5% to 2% for future retirees.**

These plan changes were recommended in an effort to align the cap with retirement age.

The below information was collected, prior to recommendation.

Regarding Cap:

Based on the 2018 actuarial study, 63% of the general employees would reach the maximum benefit limitation (cap) before they are eligible to retire. Increasing the benefit cap reduces the percentage of employees who fall on this tier.

The pension actuary, Gabriel Roeder Smith specified that the majority of the plans do not have a cap (other than the statutory 100%). They also said that of the plans that do have a cap, the range is typically 75% - 90%.

The pension attorney stated that of all the plans they represent, Surfside's benefit cap for general employees is the lowest. In addition, data from surrounding municipalities was collected identifying that Bal Harbour's cap is 100%, Bay Harbor's is 100% and Miami Beach's is 90% or 80%.

To put this in perspective, based on the current multiplier (2.8%) for general employees (non-senior management), it will take 28.5 years of service for a general employee to reach the cap ($.80 \div .028 = 28.5$).

Based on the current multiplier, for senior management (3.0%) it will take 26.6 years of service for a senior management employee to reach the cap ($.80 \div .030 = 26.6$).

Regarding COLA:

The pension actuary stated that the average COLA is 2%. The Fraternal Order of Police who represent our police officers, negotiated a 2% COLA for future retirees with their recent collective bargaining agreement. In addition our surrounding municipalities COLA is as follows:

- Bal Harbour's is 2.5%
- Miami Beach 2.5% Tier A and Tier B; 1.5% Tier C

The Town inquired on information on COLA based on the CPI with a floor of 1.5% and a ceiling of 2%. Based on long term inflation assumption, the recommendation by our actuary was 2%.

Regarding Retirement Age:

The Town of Surfside's retirement age requirements were the highest of our surrounding municipalities.

- Bay Harbor: Age 52 and 20 years of service (since 1999), or 55 and 10 years of service, or 65 regardless of years of service;
- Miami Beach: 50 and 5 years of service, or 55 and 5 years of service, 55 and 30 years of service, or 62 and 5 years of service (all based on collective bargaining agreements with their unions); and
- Bal Harbour: 57 regardless of service, or 55 and 25 years of service, or 30 years of service regardless of age.

The retirement age changes grant an opportunity to employees (majority who are public works employees) to retire and enter the Deferred Retirement Option Plan (DROP) program if they choose to, at a younger age.

For example: Solid Waste employee who was hired in 1992 (28 years of service) 58 years old, would have to wait until age 62 to retire and enter the DROP; thus, separating from service at age 67. Our solid waste crew is aging...

This also benefits other employees who are hired at a young age. They don't have to work and then wait for 35+ years to collect their pension. This will encourage employees to remain employed by the Town after vesting, rather than seeking employment elsewhere.

For example: An employee hired in 2018 whose normal retirement date (prior to this age reduction) was 2059. This particular employee would have had to wait 41 years to collect his/her pension.

Upon separation of service of those who opt to retire and not enter the DROP, the Town will more likely hire someone at a lower salary than that of the retiree. In addition, the minimum requirements for the position may have changed to include more experience and higher education.

The disparity between the general employees' benefits, the Town's sworn employees benefits (Police) and the surrounding municipalities is a challenge. The FOP negotiated retirement age reductions and a COLA increase with their 2019 – 2022 collective bargaining agreement. In addition, the Town signed a MOU with the FOP to extend the age reduction benefits to their civilian members who are covered under the general employees' plan. The surrounding municipalities offer higher caps, lower vesting requirements, lower retirement ages etc...

Enclosed please find actuarial impact statements and survey results.

Reviewed by GO

Prepared by YSM

September 6, 2016

Ms. Mayte D. Gamiotea
Pension Administrator
Retirement Plan for Employees of the
Town of Surfside
9293 Harding Avenue
Surfside, Florida 33154

**Re: Retirement Plan for Employees of the Town of Surfside
Actuarial Impact Statement**

Dear Mayte:

As requested, we are pleased to enclose three (3) copies of an Actuarial Impact Statement as of October 1, 2015 for the Proposed Ordinance under the Retirement Plan for Employees of the Town of Surfside (Plan) with the State of Florida (copy enclosed).

Background – General Employees are currently eligible for normal retirement at the earlier of (1) age 62 with 15 years of Creditable Service or (2) age 65 with 10 years of Creditable Service. A participating Town Manager is currently eligible for normal retirement at age 64 with 7 years of Creditable Service.

General Employees are currently 50% vested upon completion of 5 years of Creditable Service, increasing 10% per year until 100% vested upon completion of 10 years of Creditable Service. A participating Town Manager is currently 100% vested upon completion of 7 years of Creditable Service.

General Employees currently contribute either 5% or 6% of pensionable pay. The benefit accrual rate (multiplier) for service earned after January 31, 2003 is currently 2.0% for each year of Creditable Service for the General Employee who contributes 5% of pensionable pay and 2.5% for each year of Creditable Service for General Employees who contribute 6% of pensionable pay. The maximum benefit is currently 60% of average final compensation.

Proposed Ordinance – The proposed Ordinance:

For General Employees – Contribution rate is increased to 8% of pensionable pay for General Employees currently contributing 6% and 7% of pensionable pay for the General Employee currently contributing 5%. Benefit accrual rate (multiplier) for service earned after September 30, 2016 is 2.80% for each year of Creditable Service for General Employees who will contribute 8% of pensionable

pay. Benefit accrual rate (multiplier) for service earned after September 30, 2016 is 2.65% for each year of Creditable Service for the General Employee who will contribute 7% of pensionable pay. Maximum benefit is increased to 68% of average final compensation.

- **For Senior Management Employees** – Contribution rate is increased to 8% of pensionable pay. Benefit accrual rate (multiplier) for service earned after September 30, 2016 is 3% for each year of Creditable Service. Maximum benefit is increased to 80% of average final compensation.
- **For Town Attorney** – Retirement and vesting provisions as currently provided to a participating Town Manager.

Results – The following sets out the projected changes in the minimum annual required contributions for the Town and Employees as a dollar amount and as a percentage of covered General Employee annual payroll (\$3,121,306).

Item	Incremental Cost in Net Town Annual Required Contribution	Incremental Cost in Employee Annual Contribution
Proposed Amendment – reflect changes to General Employees only	\$ (4,828) (0.2%)	\$ 43,050 1.4%
Proposed Amendment – reflect changes to Senior Management Employees only	\$ 4,483 0.1%	\$ 19,376 0.6%
Proposed Amendment – reflect changes to Town Attorney retirement and vesting provisions	\$ 1,250 0.0%	\$ 0 0.0%
Combined Effect	\$ 905 0.0%	\$ 62,426 2.0%

Filing Requirements – We have prepared the Actuarial Impact Statement for filing with the State of Florida. Please note that this Statement must be signed and dated on behalf of the Board of Trustees. Copies of the Ordinance upon passage at first reading along with the signed and dated Actuarial Impact Statement are generally required to be filed with the State at the following address:

Mr. Douglas E. Beckendorf, A.S.A.
 Bureau of Local Retirement Services
 Division of Retirement
 Building 8
 Post Office Box 9000
 Tallahassee, Florida 32315-9000

We understand the State requires funding no later than the fiscal year next following the effective date of the increases in costs resulting from the Ordinance.

Please forward a copy of the Ordinance upon passage at second reading to update our files.

Actuarial Assumptions and Methods, Plan Provisions, Financial Data, Member Census Data – The actuarial assumptions and methods, financial data and member census data employed for purposes of our Actuarial Impact Statement are the same actuarial assumptions and methods, financial data and member census data utilized for the October 1, 2015 Actuarial Valuation.

The Plan provisions employed for purposes of our Actuarial Impact Statement are the same Plan provisions utilized for the October 1, 2015 Actuarial Valuation as modified above.

Senior Management Employees are: participating Town Manager, Town Attorney, Town Clerk, Building and Zoning Director, Code Compliance Director, Finance Director, Human Resources Director, Parks and Recreation Director, Public Works Director and Tourism, Economic Development and Community Services Director.

This Actuarial Impact Statement is intended to describe the estimated future financial effects of the proposed Plan provision changes on the Plan, and is not intended as a recommendation in favor of the benefit changes or in opposition of the Plan provision changes.

If all actuarial assumptions are met and if all future minimum required contributions are paid, Plan assets will be sufficient to pay all Plan benefits. Plan minimum required contributions are determined in compliance with the requirements of the Florida Protection of Public Employee Retirement Benefits Act with normal cost determined as a level percent of covered payroll and a level dollar amortization payment using a maximum amortization period of 30 years.

The Unfunded Actuarial Accrued Liability (UAAL) may not be appropriate for assessing the sufficiency of Plan assets to meet the estimated cost of settling benefit obligations but may be appropriate for assessing the need for or the amount of future contributions. The UAAL would be different if it reflected the market value of assets rather than the smoothed actuarial value of assets.

These calculations are based upon assumptions regarding future events. However, the Plan's long term costs will be determined by actual future events, which may differ materially from the assumptions made. These calculations are also based upon present Plan provisions that are referenced in this Actuarial Impact Statement.

If you have reason to believe the assumptions used are unreasonable, the Plan provisions are incorrectly described as referenced, important Plan provisions relevant to this

Ms. Mayte D. Gamiotea
September 6, 2016
Page Four

proposed Actuarial Impact Statement are not described or that conditions have changed since the calculations were made, you should contact the undersigned prior to relying on information in this Actuarial Impact Statement.

Future actuarial measurements may differ significantly from the current measurements presented in this report due to such factors as the following: Plan experience differing from that anticipated by the economic or demographic assumptions; changes in economic or demographic assumptions; increases or decreases expected as part of the natural operation of the methodology used for these measurements (such as the end of an amortization period); and changes in Plan provisions or applicable law. Due to the limited scope of the actuary's assignment, the actuary did not perform an analysis of the potential range of such future measurements.

This Actuarial Impact Statement should not be relied on for any purpose other than the purpose described in the primary communication. Determinations of the financial results associated with the benefits described in this report in a manner other than the intended purpose may produce significantly different results.

This Actuarial Impact Statement has been prepared by actuaries who have substantial experience valuing public employee retirement plans. To the best of our knowledge the information contained in this report is accurate and fairly presents the actuarial position of the Plan as of the Actuarial Impact Statement date. All calculations have been made in conformity with generally accepted actuarial principles and practices, with the Actuarial Standards of Practice issued by the Actuarial Standards Board and with applicable statutes.

This Actuarial Impact Statement may be provided to parties other than the Board only in its entirety and only with the permission of an approved representative of the Board.

The signing actuaries are independent of the Plan sponsor.

If you have reason to believe that the information provided in this Actuarial Impact Statement is inaccurate, or is in any way incomplete, or if you need further information in order to make an informed decision on the subject matter of this report, please contact the undersigned prior to making such decision.

The undersigned are Members of the American Academy of Actuaries and meet the Qualification Standards of the American Academy of Actuaries to render the actuarial opinion contained herein.

Ms. Mayte D. Gamiotea
September 6, 2016
Page Five

If you should have any question concerning the above or if we may be of further assistance with this matter, please do not hesitate to contact us.

Sincerest regards,



Lawrence F. Wilson, E.A., A.S.A.
Senior Consultant and Actuary



Jennifer M. Borregard, E.A.
Consultant and Actuary

Enclosures

cc: Ms. Yamileth Slate-McCloud

ORDINANCE NO. _____

AN ORDINANCE AMENDING CHAPTER 2, ARTICLE V, DIVISION 2 OF THE CODE OF THE TOWN OF SURFSIDE REGARDING THE RETIREMENT PLAN FOR EMPLOYEES OF THE TOWN OF SURFSIDE; AMENDING SECTION 2-171 OF THE TOWN CODE TO CREATE A DEFINITION OF THE TERM SENIOR MANAGEMENT EMPLOYEE; AMENDING SECTION 2-176(a)(4) OF THE TOWN CODE TO PROVIDE FOR SEVEN YEAR VESTING FOR THE TOWN ATTORNEY; AMENDING SECTION 2-176(c)(1) OF THE TOWN CODE TO INCREASE THE BENEFIT ACCRUAL RATE FOR GENERAL EMPLOYEES AND INCREASING THE BENEFIT CAP FROM 60% TO 68% OF FINAL AVERAGE COMPENSATION; AMENDING SECTION 2-176(c)(1) OF THE TOWN CODE TO INCREASE THE BENEFIT ACCRUAL RATE FOR SENIOR MANAGEMENT EMPLOYEES AND INCREASING THE BENEFIT CAP FROM 60% TO 80% OF FINAL AVERAGE COMPENSATION; AMENDING SECTION 2-180(a) OF THE TOWN CODE TO INCREASE IN THE GENERAL EMPLOYEE AND SENIOR MANAGEMENT EMPLOYEE PICK-UP PENSION CONTRIBUTION BY 2%; PROVIDING FOR SEVERABILITY; PROVIDING FOR INCLUSION IN THE CODE; PROVIDING FOR CONFLICTS AND PROVIDING FOR AN EFFECTIVE DATE.

WHEREAS, the Town of Surfside sponsors a defined benefit retirement plan for employees of the Town of Surfside (“Retirement Plan”); and

WHEREAS, the Board of Trustees of the Retirement Plan has recommended increasing the employee contribution to purchase a higher pension benefit; and

WHEREAS, general employees currently contribute either 5% or 6% of pensionable earnings; and

WHEREAS the actuary for the Board of Trustees has determined that increasing the general employee member contribution from 6% to 8% would provide a 2.8% multiplier. For the employee contributing at the 5% rate, increasing the employee member contribution to 7% would provide a 2.65% multiplier; and

WHEREAS, the Retirement Plan does not currently contain a higher tier benefit for Senior Management Employees; and

WHEREAS, the Board of Trustees has recommended increasing the multiplier and benefit cap for Senior Management Employee; and

WHEREAS, the actuary for the Board of Trustees has determined the financial effect of increasing the Senior Management Employee contribution from 6% to 8% and the multiplier from 2.5% to 3%; and

WHEREAS, the current Town Code provides for the Town Manager to be deemed fully vested at the attainment of age 64 and the completion of 7 years of creditable service; and

WHEREAS, the Retirement Plan does not currently contain a similar benefit for the Town Attorney; and

WHEREAS, the Board of Trustees has recommended providing the Town Attorney to be deemed fully vested at the attainment of age 64 and the completion of 7 years of creditable service; and

WHEREAS, the Town Commission held its first public hearing on September 13, 2016 having complied with the notice requirements required by Florida Statutes; and

WHEREAS, the Town Commission conducted a second duly noticed public hearing on these regulations as required by law on October 13, 2016; and

WHEREAS, the Town Commission finds the proposed amendments to the Code in the best interest of the Town.

NOW THEREFORE, IT IS HEREBY ORDAINED BY THE TOWN COMMISSION OF SURFSIDE TOWN, FLORIDA; AS FOLLOWS:

Section 1. Recitals. That the above stated recitals are hereby adopted and confirmed.

Section 2. Town Code Amended. SECTION 2-171, Definitions, is hereby amended and to be read as follows:

Sec. 2-171. Definitions.

The following words, terms and phrases, when used in this division, shall have the meanings ascribed to them in this section, except where the context clearly indicates a different meaning:

Senior Management Employee: For purposes of the new Senior Management Tier benefit, **Senior Management Employee means the Town Manager, Town Attorney, Town Clerk, Building and Zoning Director, Code Compliance Director, Finance Director, Human Resources Director,**

Parks and Recreation Director, Public Works Director, Tourism, Economic Development and Community Services Director.

Section 3. SECTION 2-176, Service Retirement Allowance, is hereby amended and to be read as follows:

Sec. 2-176. Service Retirement Allowance.

(a) *Normal Retirement date.* Each member who retires or otherwise terminates employment with the town on or after his normal retirement date, as determined below, shall be entitled to receive a service retirement annuity in the amount provided in subsection (c) of this section. Effective October 1, 1984, the normal retirement date for each member shall be the first day of the month coincident with or next following the earlier of:

(4) For the Town Attorney:

a. The attainment of age 62 and the completion of 15 years of creditable service; or

b. The attainment of age 64 and the completion of seven years of creditable service who shall be deemed fully vested upon the completion of seven years of creditable service.

(c) *Computation of annuity.*

(1) For members who are not police officers, the amount of monthly retirement annuity with respect to all creditable service rendered by each member prior to October 1, 1979, shall be equal to 12/3 percent of the monthly average final compensation multiplied by the number of years of creditable service rendered prior to October 1, 1979. For each employee who contributes at the rate of five percent of earnable compensation on and after January 1, 1980, the amount of monthly retirement annuity with respect to creditable service rendered after September 30, 1979, shall be equal to 12/3 percent of the monthly average final compensation multiplied by the number of years of creditable service rendered after September 30, 1979. For each employee who contributes at the rate of seven percent of earnable compensation on and after January 1, 1980, the amount of monthly retirement annuity with respect to creditable service rendered after September 30, 1979, shall be equal to two percent of the monthly average final compensation multiplied by the number of years of creditable service rendered after September 30, 1979. For each member who contributes at the rate of eight percent of earnable compensation after June 30, 1996, the amount of monthly retirement annuity with respect to creditable service rendered after June 30, 1996, shall be equal to two and one-half percent of monthly average final compensation multiplied by the number of years of creditable service rendered after June 30, 1996. For each

member who elects as of July 1, 1996 to increase his contribution from five percent to seven percent of earnable compensation, the amount of retirement annuity with respect to creditable service rendered after June 30, 1996, shall be equal to two percent of monthly average final compensation multiplied by the number of years of creditable service rendered after June 30, 1996. For each member who elects as of July 1, 1996 to increase his contribution rate to seven percent or eight percent of earnable compensation, the amount of retirement annuity with respect to creditable service rendered after September 30, 1979 but before July 1, 1996 shall be equal to one and two-thirds percent, if prior to July 1, 1996 he had been contributing at the rate of five percent, or two percent, if prior to July 1, 1996 he had been contributing at the rate of seven percent, of monthly average final compensation multiplied by the number of years of creditable service rendered after September 30, 1979 but prior to July 1, 1996. The foregoing election periods shall expire on July 31, 1996 and may not be extended for any reason. For each member who contributes at the rate of five percent of earnable compensation on and after February 1, 2003, the amount of monthly retirement annuity with respect to creditable service rendered on and after February 1, 2003 shall be equal to two percent of the monthly average final compensation multiplied by the number of years of creditable service rendered on and after February 1, 2003. For each member who contributes at the rate of six percent of earnable compensation on and after February 1, 2003, the amount of monthly retirement annuity with respect to creditable service rendered on and after February 1, 2003 shall be equal to two and one-half percent of the monthly average final compensation multiplied by the number of years of creditable service rendered on and after February 1, 2003. In no event shall the total annuity as computed above for any member exceed 60 percent of the monthly average final compensation.

For members who are not police officers or Senior Management employees, effective October 1, 2016:

(i) for each member who contributes at the rate of eight percent (8%) of earnable compensation, the amount of monthly retirement annuity with respect to creditable service rendered on and after October 1, 2016 shall be equal to two and eight-tenths percent (2.8%) of monthly average final compensation multiplied by the number of years of creditable service rendered on and after October 1, 2016;

(ii) for the member who contributes at the rate of seven percent (7%) of earnable compensation, the amount of monthly retirement annuity with respect to creditable service rendered on and after October 1, 2016 shall be equal to two and sixty-five one hundredths percent (2.65%) of monthly average final compensation multiplied by the number of years of creditable service rendered on and after October 1, 2016; and

(iii) in no event shall the total annuity as computed above for any member exceed sixty-eight percent (68%) of monthly average final compensation.

For members who are Senior Management employees, effective October 1, 2016:

(i) the amount of monthly retirement annuity with respect to creditable service rendered on and after October 1, 2016 shall be equal to three percent (3%) of monthly average final compensation multiplied by the number of years of creditable service rendered on and after October 1, 2016; and

(ii) in no event shall the total annuity as computed above for any Senior Management employee exceed eighty percent (80%) of monthly average final compensation.

Section 4. SECTION 2-180, Contributions by Members, is hereby amended and to be

read as follows:

~~(a) For members who are not police officers, beginning on the date of establishment of the plan, each town employee who is a member of the plan shall contribute five percent of earnable compensation, based on his regular salary, accruing on and after such date and up to September 30, 1979. Each member of the plan on October 1, 1979, and each employee who becomes a member after October 1, 1979, shall have the irrevocable option of contributing either five percent or seven percent of his earnable compensation from January 1, 1980. Each member of the plan as of July 1, 1996, shall have the one time irrevocable option of raising his contribution rate from five percent to either seven percent or eight percent of earnable compensation, or from seven percent to eight percent of earnable compensation. For each member who elects as of July 1, 1996 to increase his contribution from five percent to seven percent of earnable compensation, the amount of retirement annuity with respect to creditable service rendered after June 30, 1996, shall be equal to two percent of monthly average final compensation multiplied by the number of years of creditable service rendered after June 30, 1996. For each member who elects as of July 1, 1996 to increase his contribution rate to seven percent or eight percent of earnable compensation, the amount of retirement annuity with respect to creditable service rendered after September 30, 1979 but before July 1, 1996 shall be equal to one and two thirds percent, if prior to July 1, 1996 he had been contributing at the rate of five percent, or two percent, if prior to July 1, 1996 he had been contributing at the rate of seven percent, of monthly average final compensation multiplied by the number of years of creditable service rendered after September 30, 1979 but prior to July 1, 1996. The foregoing election periods shall expire on July 31, 1996 and may not be extended for any reason. Each employee who becomes a member of the plan after July 1, 1996 shall thereupon have the one time irrevocable option of contributing either five percent or eight percent of earnable compensation. Each member of the plan as of February 1, 2003 who is contributing at the rate of five percent of earnable compensation shall have the one time irrevocable option of raising his contribution rate from five percent to six percent. For each member who contributes at the rate of seven or eight percent of earnable compensation on January 31, 2003, the contribution~~

~~rate shall be six percent of earnable compensation on and after February 1, 2003. Each employee who becomes a member on or after February 1, 2003 shall contribute six percent of earnable compensation. Such contribution by any member shall cease upon the completion of the number of years of creditable service, sufficient to produce an annuity of 60 percent of average final compensation.~~ For members who are not police officers or Senior Management Employees, effective October 1, 2016:

- (i) The employee contribution for employees contributing six percent (6%) of earnable compensation shall be increased to eight percent (8%) of earnable compensation;
- (ii) The employee contribution for the employee contributing five percent (5%) of earnable compensation shall be increased to seven percent (7%) of earnable compensation;
- (iii) Employee contributions by any member shall cease upon the completion of the number of years of creditable service, sufficient to produce an annuity of sixty-eight percent (68%) of average final compensation.

For members who are Senior Management Employees, effective October 1, 2016:

- (i) The employee contribution shall be increased to eight percent (8%) of earnable compensation;
- (ii) Employee contributions by any Senior Management member shall cease upon the completion of the number of years of creditable service, sufficient to produce an annuity of eighty percent (80%) of average final compensation.

Section 5. All sections or parts of sections of the Town Code, all ordinances or parts of ordinances, and all resolutions or parts of resolutions in conflict herewith, be and the same, are hereby repealed to the extent of such conflict.

Section 6. Should this ordinance or any part thereof be declared invalid by a Court of competent jurisdiction, the invalidity of any part of this ordinance shall not otherwise affect the validity of the remaining provisions of this ordinance, which shall be deemed to have been enacted without the invalid provision.

Section 7. It is the intention of the Commission of the Town of Surfside that the provisions of this ordinance shall become and be made a part of the Code of the Town of Surfside, and that the word "ordinance" may be changed to "section," "article," or such other appropriate word or phrase in order to accomplish such intentions.

Section 8. This ordinance shall become effective upon final passage.

PASSED and ADOPTED on second reading this ____ day of _____, 2016.

On Final Reading Moved by: _____

On Final Reading Second by: _____

FINAL VOTE ON ADOPTION:

Commissioner Daniel Gielchinsky _____
Commissioner Michael Karukin _____
Commissioner Tina Paul _____
Vice Mayor Barry Cohen _____
Mayor Daniel Dietch _____

Daniel Dietch, Mayor

ATTEST:

Sandra Novoa, MMC, Town Clerk

**APPROVED AS TO FORM AND LEGALITY FOR THE USE
AND BENEFIT OF THE TOWN OF SURFSIDE ONLY:**

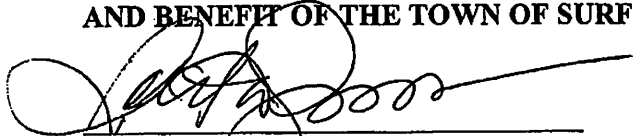

Robert D. Klausner, Esq.
General Counsel
The Retirement Plan for Employees of the Town of Surfside

**Retirement Plan for Employees of the
Town of Surfside, Florida**

Actuarial Impact Statement as of October 1, 2015

A. Description of Proposed Amendment

General Employees:

Employee contribution rate is eight percent (8%) of pensionable pay for General Employees currently contributing six percent (6%) of pensionable pay. Employee contribution rate is seven percent (7%) of pensionable pay for the General Employee currently contributing five percent (5%) of pensionable pay.

Benefit accrual rate is 2.80% per year of Creditable Service earned after September 30, 2016 for General Employees who contribute eight percent (8%) of pensionable pay. Benefit accrual rate is 2.65% per year of Creditable Service earned after September 30, 2016 for the General Employee who contributes seven percent (7%) of pensionable pay.

Maximum benefit cap is 68% of monthly average final compensation.

Senior Management Employees:

Employee contribution rate is eight percent (8%) of pensionable pay.

Benefit accrual rate is 3% per year of Creditable Service earned after September 30, 2016.

Maximum benefit cap is 80% of monthly average final compensation.

Town Attorney:

Normal retirement date shall be the earlier of (1) attainment of age 62 and completion of 15 years of Creditable Service or (2) attainment of age 64 and completion of 7 years of Creditable Service - 100% vested upon completion of seven (7) years of Creditable Service.

B. An estimate of the cost of implementing this amendment (see attachment)

C. In my opinion, the proposed changes are in compliance with Part VII, Chapter 112, Florida Statutes and Section 14, Article X of the State Constitution.

Chairman, Retirement Committee

Date

**Retirement Plan for Employees of the
Town of Surfside, Florida**

Actuarial Impact Statement as of October 1, 2015

General Employees / Senior Management Employees / Town Attorney

<u>A. Participant Data</u>	<u>Actuarial Valuation</u>	<u>Proposed Ordinance</u>
1. Active participants	59	59
2. Terminated vested participants	2	2
3. Participants receiving benefits (including DROPs)	24	24
4. Annual payroll of active employees	\$ 3,121,306	\$ 3,121,306
5. Expected payroll of active employees for the following year	\$ 3,121,306	\$ 3,121,306
 <u>B. Assets</u>		
1. Smoothed actuarial value	\$ 6,659,124	\$ 6,659,124
2. Market value	\$ 6,372,256	\$ 6,372,256
 <u>C. Liabilities</u>		
1. Actuarial present value of future expected benefit payments for active members		
a. Retirement benefits	\$ 4,143,140	\$ 4,572,192
b. Vesting benefits	949,742	988,988
c. Disability benefits	524,603	557,939
d. Return of member contributions	126,783	142,716
e. Total	<u>\$ 5,744,268</u>	<u>\$ 6,261,835</u>
2. Actuarial present value of future expected benefit payments for terminated vested members and miscellaneous	\$ 197,871	\$ 197,871
3. Actuarial present value of future expected benefit payments for those currently receiving benefits (including DROPs)	<u>\$ 3,899,103</u>	<u>\$ 3,899,103</u>
4. Total actuarial present value of future expected benefit payments	\$ 9,841,242	\$ 10,358,809
5. Actuarial accrued liabilities	\$ 7,489,177	\$ 7,778,952
6. Unfunded actuarial accrued liabilities	\$ 830,053	\$ 1,119,828

**Retirement Plan for Employees of the
Town of Surfside, Florida**

Actuarial Impact Statement as of October 1, 2015

General Employees / Senior Management Employees / Town Attorney

	<u>Actuarial Valuation</u>	<u>Proposed Ordinance</u>
D. Statement of Accumulated Plan Benefits		
1. Actuarial present value of accumulated vested benefits		
a. Participants currently receiving benefits	\$ 3,899,103	\$ 3,899,103
b. Other participants	<u>2,098,210</u>	<u>2,166,405</u>
c. Total	\$ 5,997,313	\$ 6,065,508
2. Actuarial present value of accumulated non-vested plan benefits	<u>526,026</u>	<u>660,714</u>
3. Total actuarial present value of accumulated plan benefits	\$ 6,523,339	\$ 6,726,222
E. <u>Pension Cost</u>		
1. Total normal cost	\$ 367,414	\$ 406,313
2. Payment required to amortize unfunded liability	65,535	87,858
3. Interest	<u>6,317</u>	<u>8,426</u>
4. Total required contributions	\$ 439,266	\$ 502,597
5. Item 4 as a percentage of payroll	14.1%	16.1%
6. Estimated employee contributions	\$ 186,891	\$ 249,317
7. Item 6 as a percentage of payroll	6.0%	8.0%
8. Net amount payable by Town	\$ 252,375	\$ 253,280
9. Item 8 as a percentage of payroll	8.1%	8.1%
F. <u>Disclosure of Following Items:</u>		
1. Actuarial present value of future salaries - attained age	\$ 22,876,305	\$ 22,572,170
2. Actuarial present value of future employee contributions - attained age	\$ 1,370,030	\$ 1,803,225
3. Actuarial present value of future contributions from other sources	N/A	N/A
4. Amount of active members' accumulated contributions	\$ 1,161,694	\$ 1,161,694
5. Actuarial present value of future salaries and future benefits at entry age	N/A	N/A
6. Actuarial present value of future employee contributions at entry age	N/A	N/A

**Retirement Plan for Employees of the
Town of Surfside, Florida**

Actuarial Impact Statement as of October 1, 2015

General Employees / Senior Management Employees / Town Attorney

G. Amortization of Unfunded Actuarial Accrued Liability

<u>Date Established</u>		<u>Unfunded Liability</u>	<u>Amortization Payment</u>	<u>Funding Period</u>
10/01/2009	Combined Bases *	\$ 1,984	\$ 187	18 years
10/01/2010	Actuarial (Gain) / Loss	220,977	18,080	25 years
10/01/2010	Assumption Changes	(118,720)	(9,714)	25 years
10/01/2011	Actuarial (Gain) / Loss	80,380	6,484	26 years
10/01/2012	Actuarial (Gain) / Loss	155,693	12,398	27 years
10/01/2012	Assumption Changes	117,634	9,367	27 years
10/01/2013	Actuarial (Gain) / Loss	83	7	28 years
10/01/2014	Actuarial (Gain) / Loss	84,829	6,602	29 years
10/01/2015	Actuarial (Gain) / Loss	148,934	11,473	30 years
10/01/2015	Assumption Changes	138,259	10,651	30 years
10/01/2015	Proposed Amendment	<u>289,775</u>	<u>22,323</u>	30 years
	TOTAL	\$ 1,119,828	\$ 87,858	

* Combined per Internal Revenue Code Regulation 1.412(b)-1

This actuarial valuation and/or cost determination was prepared and completed by me or under my direct supervision, and I acknowledge responsibility for the results. To the best of my knowledge, the results are complete and accurate, and in my opinion, the techniques and assumptions used are reasonable and meet the requirements and intent of Part VII, Chapter 112, Florida Statutes. There is no benefit or expense to be provided by the Plan and/or paid from the Plan's assets for which liabilities or current costs have not been established or otherwise taken into account for in the valuation. All known events or trends which may require a material increase in plan costs or required contribution rates have been taken into account in the valuation.



Lawrence F. Wilson, A.S.A.

Enrollment Number: 14-02802

Dated: September 6, 2016

**Retirement Plan for Employees of the
Town of Surfside, Florida**

Outline of Principal Provisions of the Retirement Plan

A. Effective Date:

January 1, 1962. Most recent amendatory Ordinance considered: 13-1603.

B. Eligibility Requirements:

All regular, full-time employees are eligible upon employment. The Town Manager and Town Attorney have the right to opt out of the Plan at any time.

C. Creditable Service:

All service of a member measured in years and completed calendar months since latest date of hire with the Town.

D. Average Final Compensation (AFC):

The average of basic compensation during the highest three years (five years for General Employees) of the ten years preceding termination of employment; does not include bonuses, overtime, lump sum payments of unused leave or other nonregular payments.

E. Normal Retirement:

1. Eligibility:

For sworn Police Officers, the earliest of (1) age 52 with 20 years of Creditable Service, (2) age 62 with 5 years of Creditable Service, (3) completion of 25 years of Creditable Service or (4) the completion of 15 years and 4 months of service if hired on a full time basis in March 2003. For a participating Town Manager and the Town Attorney, the earlier of (1) age 62 with 15 years of Creditable Service or (2) age 64 with 7 years of Creditable Service. For all other employees, the earlier of (1) age 62 with 15 years of Creditable Service or (2) age 65 with 10 years of Creditable Service.

2. Benefit:

Period of Service	Benefit Accrual Rate per Year of Service Based on Employee Contribution Rate of			
	5%	6%	7%	8%
Before 10/1/1979	1 2/3%	N/A	N/A	N/A
10/1/1979 - 6/30/1996	1 2/3%	N/A	2.0%	N/A
7/1/1996 - 1/31/2003	1 2/3%	N/A	2.0%	2.5%
2/1/2003 - 9/30/2005	2.0%	2.5%	N/A	N/A
10/1/2005 - 9/30/2006	2.0%	2.5%	N/A	3.0% ¹
10/1/2006 - 9/30/2016	2.0%	2.5%	N/A	3.5% ¹
10/1/2016 forward	N/A	N/A	2.65% ²	2.8% ² / 3.0% ³ / 3.5% ¹

Maximum benefit is 90% (75% prior to October 1, 2006) of AFC for Police Officers, 68% (60% prior to October 1, 2016) of AFC for General Employees and 80% (60% prior to October 1, 2016) of AFC for Senior Management Employees.

¹ For Police Officers only.

² For General Employees only.

³ For Senior Management Employees only.

**Retirement Plan for Employees of the
Town of Surfside, Florida**

Outline of Principal Provisions of the Retirement Plan

3. **Form of Payment:**

Straight life annuity with guaranteed refund of Accumulated Contributions (with options available).

F. **Early Retirement:**

1. **Eligibility:**

The earlier of (a) age 55 with 15 years of Creditable Service, or (b) 20 years of Creditable Service regardless of age.

2. **Benefit:**

Same as Normal Retirement Benefit using AFC and Creditable Service as of Early Retirement Date but payable at Normal Retirement Date assuming continued employment. Alternatively, benefits may commence immediately after reduction of 0.5% for each month early.

G. **Delayed Retirement:**

1. **Eligibility:**

Retirement after Normal Retirement Date.

2. **Benefit:**

Calculated in the same manner as Normal Retirement Benefit using AFC and Creditable Service as of delayed retirement date.

H. **Disability Retirement:**

1. **Service Connected:**

a) **Eligibility:**

Total and permanent disability incurred prior to normal retirement date as a direct result of performance of service to the Town and eligible for Social Security disability benefits.

b) **Benefit:**

75% (if injury) or 45% (if disease) of the rate of pay in effect on date of disability payable for life or until recovery. For General Employees, less Social Security disability benefits; there is an offset for Workers' Compensation to the extent that the disability benefit plus the Workers' Compensation benefit exceed 100% of preretirement salary.

2. **Non-Service Connected:**

a) **Eligibility:**

Total and permanent disability not incurred as a direct result of performance of service to the Town.

**Retirement Plan for Employees of the
Town of Surfside, Florida**

Outline of Principal Provisions of the Retirement Plan

b) Benefit:

Accrued pension benefit.

I. Death Benefit:

1. Pre-Retirement:

Refund of Accumulated Contributions

2. After Normal Retirement Date but before Actual Retirement:

Survivor benefit payable in accordance with optional form of benefit chosen by member.

3. After Retirement:

Refund of any remaining Accumulated Contributions or optional survivor's benefits if elected.

J. Accumulated Contributions:

The sum of all amounts contributed by members including 4% interest on contributions made after January 1, 1979. Effective January 1, 2009, member contributions are *picked-up* by the Town.

K. Termination Benefit:

Upon termination prior to normal or early retirement date a member shall be entitled to choose (1) or (2) below, where:

1. A refund of Accumulated Contributions.
2. The benefit as for normal retirement using AFC and Creditable Service as of date of termination multiplied by the applicable percentage on the table below, commencing upon the earliest date a member would have attained normal retirement had he remained in service (age 65 for General Employees).

<u>Years of Creditable Service</u>	<u>Percentage</u>	
	<u>General Employees</u>	<u>Police Officers</u>
Less than 5	0%	0%
5	50%	100%
6	60%	100%
7	70%	100%
8	80%	100%
9	90%	100%
10 or more	100%	100%

3. A participating Town Manager and the Town Attorney 100% vested upon completion of 7 years of Creditable Service.

**Retirement Plan for Employees of the
Town of Surfside, Florida**

Outline of Principal Provisions of the Retirement Plan

L. Cost of Living Increase

A 1.5% automatic annual cost of living increase is provided for all current and future retirees, disableds, beneficiaries and vested terminated members.

M. Deferred Retirement Option Program (DROP)

1. Eligibility: Attainment of normal retirement date.
2. The maximum period of participation in the DROP is five (5) years.
3. An employee's account in the DROP program shall be credited with interest based upon actual Fund investment return.
4. No payment may be made from DROP until the employee actually separates from service with the Town.

N. Changes From Previous Valuation

1. Normal Retirement was:

1. Eligibility:

For sworn Police Officers, the earliest of (1) age 52 with 20 years of Creditable Service, (2) age 62 with 5 years of Creditable Service, (3) completion of 25 years of Creditable Service or (4) the completion of 15 years and 4 months of service if hired on a full time basis in March 2003. For a participating Town Manager, age 64 with 7 years of Creditable Service. For all other employees, the earlier of (1) age 62 with 15 years of Creditable Service or (2) age 65 with 10 years of Creditable Service.

2. Benefit:

Period of Service	Benefit Accrual Rate per Year of Service Based on Employee Contribution Rate of			
	5%	6%	7%	8%
Before 10/1/1979	1 2/3%	N/A	N/A	N/A
10/1/1979 - 6/30/1996	1 2/3%	N/A	2%	N/A
7/1/1996 - 1/31/2003	1 2/3%	N/A	2%	2.5%
2/1/2003 - 9/30/2005	2%	2.5%	N/A	N/A
10/1/2005 - 9/30/2006	2%	2.5%	N/A	3% *
After 10/1/2006	2%	2.5%	N/A	3.5% *

Maximum benefit is 90% (75% prior to October 1, 2006) of AFC (60% of AFC for General Employees).

* For Police Officers only.

**Retirement Plan for Employees of the
Town of Surfside, Florida**

Outline of Principal Provisions of the Retirement Plan

N. Changes From Previous Valuation (cont'd)

2. Termination Benefit was:

Upon termination prior to normal or early retirement date a member shall be entitled to choose (1) or (2) below, where:

1. A refund of Accumulated Contributions.
2. The benefit as for normal retirement using AFC and Creditable Service as of date of termination multiplied by the applicable percentage on the table below, commencing upon the earliest date a member would have attained normal retirement had he remained in service (age 65 for General Employees).

<u>Years of Creditable Service</u>	<u>Percentage</u>	
	<u>General Employees</u>	<u>Police Officers</u>
Less than 5	0%	0%
5	50%	100%
6	60%	100%
7	70%	100%
8	80%	100%
9	90%	100%
10 or more	100%	100%

3. Participating Town Manager 100% vested upon completion of 7 years of Creditable Service.

**Retirement Plan for Employees of the
Town of Surfside, Florida**

**Actuarial Assumptions and Actuarial Cost Methods
Used in the Valuation**

A. Mortality

For healthy male participants, RP 2000 Annuitant Male Mortality Table, with 10% White Collar / 90% Blue Collar Adjustment for Police Officers - 50% White Collar / 50% Blue Collar Adjustment for General Employees and fully generational mortality improvements projected to each future decrement date with Scale BB. For healthy female participants, RP 2000 Annuitant Female Mortality Table, with White Collar Adjustment and fully generational mortality improvements projected to each future decrement date with Scale BB.

For disabled male Police Officers, 60% RP 2000 Disabled Male Mortality Table setback four years / 40% RP 2000 Annuitant Male Mortality Table, with White Collar Adjustment and no setback, without projected mortality improvements. For disabled female Police Officers, 60% RP 2000 Disabled Female Mortality Table set forward two years / 40% RP 2000 Annuitant Female Mortality Table, with White Collar Adjustment, without projected mortality improvements.

For disabled male General Employees, RP 2000 Disabled Male Mortality Table, setback four years, without projected mortality improvements. For disabled female General Employees, RP 2000 Disabled Female Mortality Table, set forward two years, without projected mortality improvements.

B. Investment Return

7.25%, compounded annually; net rate after investment related expenses.

C. Allowances for Expenses or Contingencies

Estimated expenses for upcoming year, not including investment related expenses.

D. Employee Withdrawal Rates

Withdrawal rates for males and females were used in accordance with the following illustrative examples:

<u>General Employees</u>	
<u>Age</u>	<u>Withdrawal Rate</u>
Under 25	30.0%
25 - 29	20.0%
30 - 34	15.0%
35 - 39	10.0%
40 - 44	9.0%
45 - 49	8.0%
50 - 54	7.0%
55 - 60	6.0%
60 & over	5.0%

**Retirement Plan for Employees of the
Town of Surfside, Florida**

**Actuarial Assumptions and Actuarial Cost Methods
Used in the Valuation**

D. Employee Withdrawal Rates (cont'd)

<u>Police Officers</u>	
<u>Service</u>	<u>Withdrawal Rate</u>
0 - 4	12.0%
5 - 6	10.0%
7	5.0%
8	2.0%
9 & over	1.0%

E. Salary Increase Factors

Current salary is assumed to increase at a rate based on the tables below.

<u>General Employees</u>	
<u>Service</u>	<u>Salary Increase</u>
0 - 4	6.5%
4 - 5	6.0%
6	5.0%
7 - 9	4.5%
10 & over	4.0%

<u>Police Officers</u>	
<u>Service</u>	<u>Salary Increase</u>
0 - 3	8.0%
3	7.0%
4 - 5	6.0%
6	5.0%
7 & over	4.0%

**Retirement Plan for Employees of the
Town of Surfside, Florida**

**Actuarial Assumptions and Actuarial Cost Methods
Used in the Valuation**

F. Disability Benefits

1. Rates: See Table Below
2. Percent Service Connected: 25% for General, 80% for Police.
3. Assume 50% of Service Connected Disabilities are due to injury and 50% are due to disease.

Age	Annual Rate of Disability	
	General Employees	Police Department
20	0.07%	0.14%
30	0.11%	0.18%
40	0.19%	0.30%
50	0.51%	1.00%
60	1.66%	0.00%

G. Smoothed Actuarial Value of Assets

The method used for determining the smoothed actuarial value of assets phases in the deviation between the expected and actual return on assets at the rate of 20% per year. The smoothed actuarial value of assets will be further adjusted to the extent necessary to fall within the corridor whose lower limit is 80% of the fair market value of plan assets and whose upper limit is 120% of the fair market value of plan assets.

H. Assumed Retirement Age

Age	Annual Rate of Retirement*	
	General Employees	Police Officers
40	N/A	3%
41-45	4%	2%
46-47	3%	1%
48-50	2%	1%
51 & over	1%	1%
NRA	40%	50%
Past NRA	50%	50%

100% of members are assumed to retire upon reaching age 70 for General Employees and age 65 for Police Officers.

* For Employees who meet the age and service eligibility requirements for normal or early retirement

**Retirement Plan for Employees of the
Town of Surfside, Florida**

**Actuarial Assumptions and Actuarial Cost Methods
Used in the Valuation**

I. Marriage Assumption

100% of all members are assumed to be married. Wives are assumed to be three years younger than their husbands.

J. Actuarial Funding Method

Normal Retirement, Termination, Disability, and Death Benefits: Entry-Age-Actuarial Cost Method. Under this method the normal cost for each active employee is the amount which is calculated to be a level percentage of pay that would be required annually from his age at hire to his assumed retirement age to fund his estimated benefits, assuming the Plan has always been in effect. The normal cost for the Plan is the sum of such amounts for all employees. The actuarial accrued liability as of any valuation date for each active employee or inactive employee who is eligible to receive benefits under the Plan is the excess of the actuarial present value of estimated future benefits over the actuarial present value of current and future normal costs. The unfunded actuarial accrued liability as of any valuation date is the excess of the smoothed actuarial accrued liability over the actuarial value of assets of the Plan.

K. Change From Previous Valuation

None.

ORDINANCE NO. 16-1652

AN ORDINANCE AMENDING CHAPTER 2, ARTICLE V, DIVISION 2 OF THE CODE OF THE TOWN OF SURFSIDE REGARDING THE RETIREMENT PLAN FOR EMPLOYEES OF THE TOWN OF SURFSIDE; AMENDING SECTION 2-171 OF THE TOWN CODE TO CREATE A DEFINITION OF THE TERM SENIOR MANAGEMENT EMPLOYEE; AMENDING SECTION 2-176(a)(4) OF THE TOWN CODE TO PROVIDE FOR SEVEN YEAR VESTING FOR THE TOWN ATTORNEY; AMENDING SECTION 2-176(c)(1) OF THE TOWN CODE TO INCREASE THE BENEFIT ACCRUAL RATE FOR GENERAL EMPLOYEES AND INCREASING THE BENEFIT CAP FROM 60% TO 68% OF FINAL AVERAGE COMPENSATION; AMENDING SECTION 2-176(c)(1) OF THE TOWN CODE TO INCREASE THE BENEFIT ACCRUAL RATE FOR SENIOR MANAGEMENT EMPLOYEES AND INCREASING THE BENEFIT CAP FROM 60% TO 80% OF FINAL AVERAGE COMPENSATION; AMENDING SECTION 2-180(a) OF THE TOWN CODE TO INCREASE IN THE GENERAL EMPLOYEE AND SENIOR MANAGEMENT EMPLOYEE PICK-UP PENSION CONTRIBUTION BY 2%; PROVIDING FOR SEVERABILITY; PROVIDING FOR INCLUSION IN THE CODE; PROVIDING FOR CONFLICTS AND PROVIDING FOR AN EFFECTIVE DATE.

WHEREAS, the Town of Surfside sponsors a defined benefit retirement plan for employees of the Town of Surfside ("Retirement Plan"); and

WHEREAS, the Board of Trustees of the Retirement Plan has recommended increasing the employee contribution to purchase a higher pension benefit; and

WHEREAS, general employees currently contribute either 5% or 6% of pensionable earnings; and

WHEREAS the actuary for the Board of Trustees has determined that increasing the general employee member contribution from 6% to 8% would provide a 2.8% multiplier. For the employee contributing at the 5% rate, increasing the employee member contribution to 7% would provide a 2.65% multiplier; and

WHEREAS, the Retirement Plan does not currently contain a higher tier benefit for Senior Management Employees; and

WHEREAS, the Board of Trustees has recommended increasing the multiplier and benefit cap for Senior Management Employee; and

WHEREAS, the actuary for the Board of Trustees has determined the financial effect of increasing the Senior Management Employee contribution from 6% to 8% and the multiplier from 2.5% to 3%; and

WHEREAS, the current Town Code provides for the Town Manager to be deemed fully vested at the attainment of age 64 and the completion of 7 years of creditable service; and

WHEREAS, the Retirement Plan does not currently contain a similar benefit for the Town Attorney; and

WHEREAS, the Board of Trustees has recommended providing the Town Attorney to be deemed fully vested at the attainment of age 64 and the completion of 7 years of credited service; and

WHEREAS, the Town Commission held its first public hearing on September 13, 2016 having complied with the notice requirements required by Florida Statutes; and

WHEREAS, the Town Commission conducted a second duly noticed public hearing on these regulations as required by law on October 13, 2016; and

WHEREAS, the Town Commission finds the proposed amendments to the Code in the best interest of the Town.

NOW THEREFORE, IT IS HEREBY ORDAINED BY THE TOWN COMMISSION OF SURFSIDE TOWN, FLORIDA; AS FOLLOWS:

Section 1. Recitals. That the above stated recitals are hereby adopted and confirmed.

Section 2. Town Code Amended. SECTION 2-171, Definitions, is hereby amended and to be read as follows:

Sec. 2-171. Definitions.

The following words, terms and phrases, when used in this division, shall have the meanings ascribed to them in this section, except where the context clearly indicates a different meaning:

Senior Management Employee: For purposes of the new Senior Management Tier benefit, **Senior Management Employee means the Town Manager, Town Attorney, Town Clerk, Building and Zoning Department Director, Code Compliance Director, Finance Director, Human**

Resources Director, Parks and Recreation Director, Public Works Director, Tourism, Economic Development and Community Services Director.

Section 3. SECTION 2-176, Service Retirement Allowance, is hereby amended and to be read as follows:

Sec. 2-176. Service Retirement Allowance.

(a) *Normal Retirement date.* Each member who retires or otherwise terminates employment with the town on or after his normal retirement date, as determined below, shall be entitled to receive a service retirement annuity in the amount provided in subsection (c) of this section. Effective October 1, 1984, the normal retirement date for each member shall be the first day of the month coincident with or next following the earlier of:

(4) For the Town Attorney:

a. The attainment of age 62 and the completion of 15 years of creditable service; or

b. The attainment of age 64 and the completion of seven years of creditable service who shall be deemed fully vested upon the completion of seven years of creditable service.

(c) *Computation of annuity.*

(1) For members who are not police officers, the amount of monthly retirement annuity with respect to all creditable service rendered by each member prior to October 1, 1979, shall be equal to 12/3 percent of the monthly average final compensation multiplied by the number of years of creditable service rendered prior to October 1, 1979. For each employee who contributes at the rate of five percent of earnable compensation on and after January 1, 1980, the amount of monthly retirement annuity with respect to creditable service rendered after September 30, 1979, shall be equal to 12/3 percent of the monthly average final compensation multiplied by the number of years of creditable service rendered after September 30, 1979. For each employee who contributes at the rate of seven percent of earnable compensation on and after January 1, 1980, the amount of monthly retirement annuity with respect to creditable service rendered after September 30, 1979, shall be equal to two percent of the monthly average final compensation multiplied by the number of years of creditable service rendered after September 30, 1979. For each member who contributes at the rate of eight percent of earnable compensation after June 30, 1996, the amount of monthly retirement annuity with respect to creditable service rendered after June 30, 1996, shall be equal to two and one-half percent of monthly average final compensation multiplied by the number of years of creditable service rendered after June 30, 1996. For each

member who elects as of July 1, 1996 to increase his contribution from five percent to seven percent of earnable compensation, the amount of retirement annuity with respect to creditable service rendered after June 30, 1996, shall be equal to two percent of monthly average final compensation multiplied by the number of years of creditable service rendered after June 30, 1996. For each member who elects as of July 1, 1996 to increase his contribution rate to seven percent or eight percent of earnable compensation, the amount of retirement annuity with respect to creditable service rendered after September 30, 1979 but before July 1, 1996 shall be equal to one and two-thirds percent, if prior to July 1, 1996 he had been contributing at the rate of five percent, or two percent, if prior to July 1, 1996 he had been contributing at the rate of seven percent, of monthly average final compensation multiplied by the number of years of creditable service rendered after September 30, 1979 but prior to July 1, 1996. The foregoing election periods shall expire on July 31, 1996 and may not be extended for any reason. For each member who contributes at the rate of five percent of earnable compensation on and after February 1, 2003, the amount of monthly retirement annuity with respect to creditable service rendered on and after February 1, 2003 shall be equal to two percent of the monthly average final compensation multiplied by the number of years of creditable service rendered on and after February 1, 2003. For each member who contributes at the rate of six percent of earnable compensation on and after February 1, 2003, the amount of monthly retirement annuity with respect to creditable service rendered on and after February 1, 2003 shall be equal to two and one-half percent of the monthly average final compensation multiplied by the number of years of creditable service rendered on and after February 1, 2003. In no event shall the total annuity as computed above for any member exceed 60 percent of the monthly average final compensation.

For members who are not police officers or Senior Management employees, effective October 1, 2016:

(i) for each member who contributes at the rate of eight percent (8%) of earnable compensation, the amount of monthly retirement annuity with respect to creditable service rendered on and after October 1, 2016 shall be equal to two and eight-tenths percent (2.8%) of monthly average final compensation multiplied by the number of years of creditable service rendered on and after October 1, 2016;

(ii) for the member who contributes at the rate of seven percent (7%) of earnable compensation, the amount of monthly retirement annuity with respect to creditable service rendered on and after October 1, 2016 shall be equal to two and sixty-five one hundredths percent (2.65%) of monthly average final compensation multiplied by the number of years of creditable service rendered on and after October 1, 2016; and

(iii) in no event shall the total annuity as computed above for any member exceed sixty-eight percent (68%) of monthly average final compensation.

For members who are Senior Management employees, effective October 1, 2016:

(i) the amount of monthly retirement annuity with respect to creditable service rendered on and after October 1, 2016 shall be equal to three percent (3%) of monthly average final compensation multiplied by the number of years of creditable service rendered on and after October 1, 2016; and

(ii) in no event shall the total annuity as computed above for any Senior Management employee exceed eighty percent (80%) of monthly average final compensation.

Section 4. SECTION 2-180, Contributions by Members, is hereby amended and to be

read as follows:

~~(a) For members who are not police officers, beginning on the date of establishment of the plan, each town employee who is a member of the plan shall contribute five percent of earnable compensation, based on his regular salary, accruing on and after such date and up to September 30, 1979. Each member of the plan on October 1, 1979, and each employee who becomes a member after October 1, 1979, shall have the irrevocable option of contributing either five percent or seven percent of his earnable compensation from January 1, 1980. Each member of the plan as of July 1, 1996, shall have the one-time irrevocable option of raising his contribution rate from five percent to either seven percent or eight percent of earnable compensation, or from seven percent to eight percent of earnable compensation. For each member who elects as of July 1, 1996 to increase his contribution from five percent to seven percent of earnable compensation, the amount of retirement annuity with respect to creditable service rendered after June 30, 1996, shall be equal to two percent of monthly average final compensation multiplied by the number of years of creditable service rendered after June 30, 1996. For each member who elects as of July 1, 1996 to increase his contribution rate to seven percent or eight percent of earnable compensation, the amount of retirement annuity with respect to creditable service rendered after September 30, 1979 but before July 1, 1996 shall be equal to one and two-thirds percent, if prior to July 1, 1996 he had been contributing at the rate of five percent, or two percent, if prior to July 1, 1996 he had been contributing at the rate of seven percent, of monthly average final compensation multiplied by the number of years of creditable service rendered after September 30, 1979 but prior to July 1, 1996. The foregoing election periods shall expire on July 31, 1996 and may not be extended for any reason. Each employee who becomes a member of the plan after July 1, 1996 shall thereupon have the one-time irrevocable option of contributing either five percent or eight percent of earnable compensation. Each member of the plan as of February 1, 2003 who is contributing at the rate of five percent of earnable compensation shall have the one-time irrevocable option of raising his contribution rate from five percent to six percent. For each member who contributes at the rate of seven or eight percent of earnable compensation on January 31, 2003, the contribution~~

~~rate shall be six percent of earnable compensation on and after February 1, 2003. Each employee who becomes a member on or after February 1, 2003 shall contribute six percent of earnable compensation. Such contribution by any member shall cease upon the completion of the number of years of creditable service, sufficient to produce an annuity of 60 percent of average final compensation. For members who are not police officers or Senior Management Employees, effective October 1, 2016:~~

- (i) The employee contribution for employees contributing six percent (6%) of earnable compensation shall be increased to eight percent (8%) of earnable compensation;
- (ii) The employee contribution for the employee contributing five percent (5%) of earnable compensation shall be increased to seven percent (7%) of earnable compensation;
- (iii) Employee contributions by any member shall cease upon the completion of the number of years of creditable service, sufficient to produce an annuity of sixty-eight percent (68%) of average final compensation.

For members who are Senior Management Employees, effective October 1, 2016:

- (i) The employee contribution shall be increased to eight percent (8%) of earnable compensation;
- (ii) Employee contributions by any Senior Management member shall cease upon the completion of the number of years of creditable service, sufficient to produce an annuity of eighty percent (80%) of average final compensation.

Section 5. All sections or parts of sections of the Town Code, all ordinances or parts of ordinances, and all resolutions or parts of resolutions in conflict herewith, be and the same, are hereby repealed to the extent of such conflict.

Section 6. Should this ordinance or any part thereof be declared invalid by a Court of competent jurisdiction, the invalidity of any part of this ordinance shall not otherwise affect the validity of the remaining provisions of this ordinance, which shall be deemed to have been enacted without the invalid provision.

Section 7. It is the intention of the Commission of the Town of Surfside that the provisions of this ordinance shall become and be made a part of the Code of the Town of Surfside, and that the word "ordinance" may be changed to "section," "article," or such other appropriate word or phrase in order to accomplish such intentions.

Section 8. This ordinance shall become effective upon final passage.

PASSED and ADOPTED on second reading this 13th day of October 2016.

On Final Reading Moved by: Commissioner Paul

On Final Reading Second by: Commissioner Karukin

FINAL VOTE ON ADOPTION:

Commissioner Daniel Gielchinsky	<u>yes</u>
Commissioner Michael Karukin	<u>yes</u>
Commissioner Tina Paul	<u>yes</u>
Vice Mayor Barry Cohen	<u>yes</u>
Mayor Daniel Dietch	<u>yes</u>



Daniel Dietch, Mayor

ATTEST: 

Sandra Novoa, MMC, Town Clerk

APPROVED AS TO FORM AND LEGALITY FOR THE USE AND BENEFIT OF THE TOWN OF SURFSIDE ONLY:

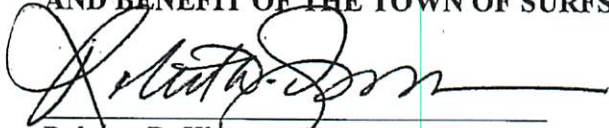

Robert D. Klausner, Esq.
General Counsel
The Retirement Plan for Employees of the Town of Surfside

January 10, 2020

Ms. Mayte D. Gamiotea
Pension Administrator
Retirement Plan for Employees of the
Town of Surfside
9293 Harding Avenue
Surfside, Florida 33154

**Re: Retirement Plan for Employees of the Town of Surfside
Actuarial Impact Statement**

Dear Mayte:

As requested, we are pleased to enclose twelve (12) copies of our Actuarial Impact Statement as of October 1, 2018 for filing the proposed Ordinance under the Retirement Plan for Employees of the Town of Surfside (Plan) with the State of Florida (copy enclosed) prior to second reading.

Background – The Plan currently provides the General Employees, Communication Operators and Senior Management Employees with the following provisions:

- Normal retirement eligibility is the earlier of:
 - (1) attainment of age sixty-two (62) and completion of fifteen (15) years of service or
 - (2) attainment of age sixty-five (65) and completion of ten (10) years of service.
- Automatic annual cost of living increases of 1.5%.
- Maximum benefits are 68% of Average Final Compensation (AFC) for General Employees and Communication Operators and 80% of AFC for Senior Management Employees.

Proposed Ordinance – The proposed Ordinance provides for General Employees, Communication Operators and Senior Management Employees as follows:

- Normal Retirement Eligibility
Allow for normal retirement upon the earliest of:
 - (1) attainment of age fifty (50) and completion of twenty (20) years of service,
 - (2) attainment of age fifty-two (52) and completion of fifteen (15) years of service or
 - (3) attainment of age fifty-five (55) and completion of ten (10) years of service.
- Automatic Annual Cost of Living Increases – excluding Communication Operators
Increasing automatic annual cost of living increase from 1.5% to 2.0% for retirees, disableds, beneficiaries and vested terminated members who retire on or after January 1, 2020.

- Maximum Benefit Cap increased to 80% of AFC for General Employees and Communication Operators.

Cost – The total impact of the proposed Ordinance results in an expected increase in the first year Net Town Minimum Funding Payment of \$173,483.

Filing Requirements – We have prepared the Actuarial Impact Statement for filing with the State of Florida. Please note that this Statement must be signed and dated on behalf of the Board of Trustees. Copies of the Ordinance upon passage at first reading along with the signed and dated Actuarial Impact Statement are generally required to be filed with the State at the following address:

Mr. Douglas E. Beckendorf, A.S.A.
Bureau of Local Retirement Services
Division of Retirement
Building 8
Post Office Box 9000
Tallahassee, Florida 32315-9000

We understand the State requires funding any increases in costs no later than the fiscal year next following the effective date of the Ordinance.

Please forward a copy of the Ordinance upon passage at second reading to update our files.

Actuarial assumptions and methods, financial data, Plan provisions and member census data – The actuarial assumptions and methods, financial data and member census data employed for purposes of our Actuarial Impact Statement are the same actuarial assumptions and methods, financial data and member census data utilized for the October 1, 2018 Actuarial Valuation of the Plan with the following exceptions:

Normal Retirement rates were changed to the following:

- ❖ For General Employees and Communication Operators:
 - Ages before reaching the maximum benefit cap:
 - Ages < 65 = 5%
 - Ages 65 to 69 = 50%
 - Age 70 = 100%
 - Ages at or after reaching the maximum benefit cap:
 - All Ages = 100%

- ❖ For Senior Management:
 - Ages before reaching the maximum benefit cap:
 - Ages < 65 = 5%
 - Ages 65 to 69 = 50%
 - Age 70 = 100%
 - Ages at or after reaching the maximum benefit cap:
 - Ages < 65 = 35%
 - Ages 65 to 69 = 50%
 - Age 70 = 100%

The Plan provisions employed for purposes of our Actuarial Impact Statement are the same Plan provisions utilized in the October 1, 2018 Actuarial Valuation of the Plan with the exception of the proposed changes described above.

Risk Assessment – Risk assessment may include scenario tests, sensitivity, or stress tests, stochastic modeling, and a comparison of the present value of benefits at low-risk discount rates. We are prepared to perform such assessment to aid the Town in the decision making process. Please refer to the October 1, 2018 Actuarial Valuation Report dated July 22, 2019 for additional discussion regarding the risks associated with measuring the accrued liability and the minimum funding payment.

This Actuarial Impact Statement is intended to describe the estimated future financial effects of the proposed benefit changes on the Plan and is not intended as a recommendation in favor of the benefit changes nor in opposition to the benefit changes.

If all actuarial assumptions are met and if all current and future minimum required contributions are paid, Plan assets will be sufficient to pay all Plan benefits, future contributions are expected to remain relatively stable as a percent of payroll and the funded status is expected to improve. Plan minimum required contributions are determined in compliance with the requirements of the Florida Protection of Public Employee Retirement Benefits Act with normal cost determined as a level percent of covered payroll and a level dollar amortization payment using an initial amortization period of 30 years.

The Unfunded Actuarial Accrued Liability (UAAL) may not be appropriate for assessing the sufficiency of Plan assets to meet the estimated cost of settling benefit obligations but may be appropriate for assessing the need for or the amount of future contributions. The UAAL would be different if it reflected the market value of assets rather than the smoothed value of assets.

These calculations are based upon assumptions regarding future events. However, the Plan's long term costs will be determined by actual future events, which may differ materially from the

Ms. Mayte D. Gamiotea
January 10, 2020
Page Four

assumptions made. These calculations are also based upon present and proposed Plan provisions that are outlined or referenced in this Actuarial Impact Statement.

If you have reason to believe the assumptions used are unreasonable, the Plan provisions are incorrectly described or referenced, important Plan provisions relevant to this Actuarial Impact Statement are not described or that conditions have changed since the calculations were made, you should contact the undersigned prior to relying on information in this Actuarial Impact Statement.

If you have reason to believe that the information provided in this Actuarial Impact Statement is inaccurate, or is in any way incomplete, or if you need further information in order to make an informed decision on the subject matter of this report, please contact the undersigned prior to making such decision.

Future actuarial measurements may differ significantly from the current measurements presented in this report due to such factors as the following: Plan experience differing from that anticipated by the economic or demographic assumptions; changes in economic or demographic assumptions; increases or decreases expected as part of the natural operation of the methodology used for these measurements (such as the end of an amortization period) and changes in Plan provisions or applicable law. Due to the limited scope of our assignment, we did not perform an analysis of the potential range of such future measurements.

This Actuarial Impact Statement should not be relied on for any purpose other than the purpose described in the primary communication. Determinations of the financial results associated with the benefits described in this report in a manner other than the intended purpose may produce significantly different results.

This Actuarial Impact Statement has been prepared by actuaries who have substantial experience valuing public employee retirement systems. To the best of our knowledge the information contained in this report is accurate and fairly presents the actuarial position of the Plan as of the valuation date. All calculations have been made in conformity with generally accepted actuarial principles and practices, with the Actuarial Standards of Practice issued by the Actuarial Standards Board and with applicable statutes.

This Actuarial Impact Statement may be provided to parties other than the Board only in its entirety and only with the permission of an approved representative of the Board.

The signing actuaries are independent of the Plan sponsor.

The undersigned are Members of the American Academy of Actuaries and meet the Qualification Standards of the American Academy of Actuaries to render the actuarial opinion contained herein.



Ms. Mayte D. Gamiotea
January 10, 2020
Page Five

If you should have any question concerning the above or if we may be of further assistance with this matter, please do not hesitate to contact us.

Sincerest regards,

Michelle Jones

Shelly L. Jones, A.S.A., E.A., M.A.A.A, F.C.A.
Consultant and Actuary

Nicolas Lahaye

Nicolas Lahaye, F.S.A., E.A., M.A.A.A, F.C.A.
Consultant and Actuary

Enclosures

ORDINANCE NO. _____

AN ORDINANCE AMENDING CHAPTER 2, ARTICLE V, DIVISION 2 OF THE CODE OF THE TOWN OF SURFSIDE REGARDING THE RETIREMENT PLAN FOR EMPLOYEES OF THE TOWN OF SURFSIDE; AMENDING SECTION 2-176(a) OF THE TOWN CODE TO LOWER RETIREMENT AGES FOR NON-PUBLIC SAFETY EMPLOYEES CONSISTENT WITH MAXIMUM BENEFIT LIMITATIONS; AMENDING SECTION 2-176(c) OF THE TOWN CODE TO INCREASE THE MAXIMUM BENEFIT LIMITATION FROM 68% TO 80% FOR GENERAL EMPLOYEES; AMENDING SECTION 2-192 OF THE TOWN CODE TO INCREASE THE COST OF LIVING ADJUSTMENT FROM 1.5% TO 2% PER YEAR FOR NON-PUBLIC SAFETY EMPLOYEES; PROVIDING FOR SEVERABILITY; PROVIDING FOR CODIFICATION; AND PROVIDING AN EFFECTIVE DATE.

WHEREAS, the Town of Surfside sponsors a defined benefit retirement plan for employees of the Town of Surfside (“Retirement Plan”);

WHEREAS, the Board of Trustees of the Retirement Plan, after a review of benefits in surrounding cities, has recommended enhancing pension benefits to align retirement ages with the Retirement Plan’s maximum benefit limitation (hereinafter the “benefit cap”);

WHEREAS, general employees currently contribute 8% of pensionable earnings;

WHEREAS, the maximum benefit cap for general employees is currently 68% for general employees and 80% for management employees;

WHEREAS, approximately 63% of general employees reach the maximum benefit cap of 68% before they are eligible to retire;

WHEREAS, notwithstanding the pension cost, there are anticipated to be savings from a recruitment standpoint, by reducing turnover and making the Retirement Plan more competitive with surrounding cities;

WHEREAS, the Commission of the Town of Surfside believes that the adoption of this amendment is in the best interests of the citizens and taxpayers of the Town;

NOW, THEREFORE, BE IT ORDAINED by the Town Commission of the Town of

Surfside:

Section 1. SECTION 2-176(a), Service Retirement Allowance, is hereby amended and to be read as follows:

Sec. 2-176. Service Retirement Allowance.

- (a) Normal retirement date. Each member who retires or otherwise terminates employment with the town on or after his normal retirement date, as determined below, shall be entitled to receive a service retirement annuity in the amount provided in subsection (c) of this section. Effective ~~October 1, 1984~~ January 1, 2020, the normal retirement date for each member shall be the first day of the month coincident with or next following the earlier of:

- (2) For members who are not sworn law enforcement officers, the earliest of:
- a. ~~The attainment of age 62 and the completion of 15 years of creditable service; or~~
 - b. ~~The attainment of age 65 and the completion of ten years of creditable service.~~
 - a. The attainment of age fifty (50) and completion of twenty (20) years of service;
 - b. The attainment of age fifty-two (52) and completion of fifteen (15) years of service; or
 - c. The attainment of age fifty-five (55) and completion of ten (10) years of service.

Section 2. SECTION 2-176(c), Service Retirement Allowance, is hereby amended and to be read as follows:

Sec. 2-176. Service Retirement Allowance.

- (c) Computation of annuity:
- (1) For members who are not police officers, the amount of monthly retirement annuity with respect to all creditable service rendered by each member prior to October 1, 1979, shall be equal to 1 2/3 percent of the monthly average final compensation multiplied by the number of years of creditable service rendered prior to October 1, 1979. For each employee who contributes at the rate of five percent of earnable compensation on and after January 1, 1980, the amount of monthly retirement annuity with respect to creditable service rendered after September 30, 1979, shall be equal to 1 2/3 percent of the monthly average final compensation multiplied by the number of years of creditable service rendered

after September 30, 1979. For each employee who contributes at the rate of seven percent of earnable compensation on and after January 1, 1980, the amount of monthly retirement annuity with respect to creditable service rendered after September 30, 1979, shall be equal to two percent of the monthly average final compensation multiplied by the number of years of creditable service rendered after September 30, 1979. For each member who contributes at the rate of eight percent of earnable compensation after June 30, 1996, the amount of monthly retirement annuity with respect to creditable service rendered after June 30, 1996, shall be equal to two and one-half percent of monthly average final compensation multiplied by the number of years of creditable service rendered after June 30, 1996. For each member who elects as of July 1, 1996 to increase his contribution from five percent to seven percent of earnable compensation, the amount of retirement annuity with respect to creditable service rendered after June 30, 1996, shall be equal to two percent of monthly average final compensation multiplied by the number of years of creditable service rendered after June 30, 1996. For each member who elects as of July 1, 1996 to increase his contribution rate to seven percent or eight percent of earnable compensation, the amount of retirement annuity with respect to creditable service rendered after September 30, 1979 but before July 1, 1996 shall be equal to one and two-thirds percent, if prior to July 1, 1996 he had been contributing at the rate of five percent, or two percent, if prior to July 1, 1996 he had been contributing at the rate of seven percent, of monthly average final compensation multiplied by the number of years of creditable service rendered after September 30, 1979 but prior to July 1, 1996. The foregoing election periods shall expire on July 31, 1996 and may not be extended for any reason. For each member who contributes at the rate of five percent of earnable compensation on and after February 1, 2003, the amount of monthly retirement annuity with respect to creditable service rendered on and after February 1, 2003 shall be equal to two percent of the monthly average final compensation multiplied by the number of years of creditable service rendered on and after February 1, 2003. For each member who contributes at the rate of six percent of earnable compensation on and after February 1, 2003, the amount of monthly retirement annuity with respect to creditable service rendered on and after February 1, 2003 shall be equal to two and one-half percent of the monthly average final compensation multiplied by the number of years of creditable service rendered on and after February 1, 2003. In no event shall the total annuity as computed above for any member exceed 60 percent of the monthly average final compensation.

For members who are not police officers or senior management employees, effective October 1, 2016:

- (i) For each member who contributes at the rate of eight percent (8%) of earnable compensation, the amount of monthly retirement annuity with respect to creditable service rendered on and after October 1, 2016 shall be equal to two and eight-tenths percent (2.8%) of monthly average final

compensation multiplied by the number of years of creditable service rendered on and after October 1, 2016;

- (ii) For the member who contributes at the rate of seven percent (7%) of earnable compensation, the amount of monthly retirement annuity with respect to creditable service rendered on and after October 1, 2016 shall be equal to two and sixty-five one hundredths percent (2.65%) of monthly average final compensation multiplied by the number of years of creditable service rendered on and after October 1, 2016; and
- (iii) In no event shall the total annuity as computed above for any member exceed ~~sixty-eight~~ eighty percent (~~68%~~ 80%) of monthly average final compensation, effective January 1, 2020.

Section 3. SECTION 2-192, Cost-of-living adjustment for retired members and their beneficiaries, is hereby amended and to be read as follows:

Sec. 2-192. - Cost-of-living adjustment for retired members and their beneficiaries.

- (a) The purpose of this section is to provide a cost-of-living adjustment to the benefits payable to retired members on or after January 1, 2004 and their beneficiaries.
- (b) Commencing on the first day of January, 2004 and on the first day of each January thereafter, the benefit of each retired member or beneficiary shall be adjusted as follows:
 - (1) The amount of the monthly benefit payable for the 12-month period commencing on the first adjustment date shall be the amount of the monthly benefit plus one and one-half percent. The amount of the monthly benefit payable for subsequent twelve-month periods shall be the amount of the monthly benefit being received on January 1 immediately preceding the adjustment date plus an amount equal to one and one-half percent of said benefit. Effective January 1, 2020, the cost of living benefit shall be two percent (2%) for all members who retire on or after January 1, 2020.

Section 4. All sections or parts of sections of the Town Code, all ordinances or parts of ordinances, and all resolutions or parts of resolutions in conflict herewith, be and the same, are hereby repealed to the extent of such conflict.

Section 5. Should this ordinance or any part thereof be declared invalid by a Court of competent jurisdiction, the invalidity of any part of this ordinance shall not otherwise affect the validity of the remaining provisions of this ordinance, which shall be deemed to have been enacted without the invalid provision.

Commissioner Barry Cohen	yes___	no___
Commissioner Michael Karukin	yes___	no___
Commissioner Tina Paul	yes___	no___

Actuarial Impact Statement as of October 1, 2018

A. Description of Proposed Amendment

Normal Retirement Eligibility

For General Employees, Communication Operators and Senior Management Employees, the earliest of

- (1) Age 50 with 20 years of Creditable Service;
- (2) Age 52 with 15 years of Creditable Service; or
- (3) Age 55 with 10 years of Creditable Service.

Normal Retirement Benefit

Maximum benefit is 80% of AFC for General Employees and Communication Operators.

Cost of Living Increase

For General and Senior Management retirees, disableds, beneficiaries and vested terminated members who retire on or after January 1, 2020, a 2.0% automatic annual cost of living increase is provided.

- B. An estimate of the cost implementing this amendment is attached.
- C. In my opinion, the proposed changes are in compliance with Part VII, Chapter 112, Florida Statutes and Section 14, Article X of the State Constitution.

Chairman, Pension Board

Date

Actuarial Impact Statement as of October 1, 2018

General Employees / Senior Management Employees

	Valuation <u>10/01/2018</u>	Actuarial Impact Statement <u>10/01/2018</u>
A. <u>Participant Data</u>		
1. Active participants	64	64
2. Retired, disabled and beneficiaries receiving benefits (including DROPs)	24	24
3. Terminated vested participants	4	4
4. Annual payroll of active participants	\$ 3,422,731	\$ 3,422,731
5. Expected payroll of active employees for the following year	\$ 3,422,731	\$ 3,422,731
6. Annual benefits payable to those currently receiving benefits	\$ 379,868	\$ 379,868
B. <u>Assets</u>		
1. Smoothed actuarial value	\$ 8,784,384	\$ 8,784,384
2. Market value	\$ 8,890,663	\$ 8,890,663
C. <u>Liabilities</u>		
1. Actuarial present value of future expected benefit payments for active members		
a. Retirement benefits	\$ 6,216,110	\$ 8,573,271
b. Vesting benefits	1,156,020	802,101
c. Disability benefits	725,504	662,859
d. Return of member contributions	134,010	131,584
e. Total	\$ 8,231,644	\$ 10,169,815
2. Actuarial present value of future expected benefit payments for terminated vested members and miscellaneous	\$ 285,863	\$ 285,863
3. Actuarial present value of future expected benefit payments for members currently receiving benefits (including DROPs)	\$ 4,291,037	\$ 4,291,037
4. Total actuarial present value of future expected benefit payments	\$ 12,808,544	\$ 14,746,715
5. Actuarial accrued liabilities	\$ 10,055,380	\$ 11,487,613
6. Unfunded actuarial accrued liabilities	\$ 1,270,996	\$ 2,703,229

Actuarial Impact Statement as of October 1, 2018

General Employees / Senior Management Employees

	<u>Valuation</u> <u>10/01/2018</u>	<u>Actuarial Impact</u> <u>Statement</u> <u>10/01/2018</u>
D. <u>Statement of Accumulated Plan Benefits</u>		
1. Actuarial present value of accumulated vested benefits		
a. Participants currently receiving benefits	\$ 4,291,037	\$ 4,291,037
b. Terminated vested members and miscellaneous	285,863	285,863
c. Other participants	3,450,249	3,982,061
d. Total	<u>\$ 8,027,149</u>	<u>\$ 8,558,961</u>
2. Actuarial present value of accumulated non-vested plan benefits	<u>575,577</u>	<u>598,161</u>
3. Total actuarial present value of accumulated plan benefits	\$ 8,602,726	\$ 9,157,122
E. <u>Pension Cost</u>		
1. Total normal cost	\$ 435,758	\$ 498,908
2. Payment required to amortize unfunded liability	102,938	213,270
3. Interest	9,240	9,241
4. Total required contributions	<u>\$ 547,936</u>	<u>\$ 721,419</u>
5. Item 4 as a percentage of payroll	16.0%	21.1%
6. Estimated employee contributions	\$ 273,396	\$ 273,396
7. Item 6 as a percentage of payroll	8.0%	8.0%
8. Net amount payable by Town	\$ 274,540	\$ 448,023
9. Item 8 as a percentage of payroll	8.0%	13.1%
F. <u>Disclosure of Following Items:</u>		
1. Actuarial present value of future salaries - attained age	\$ 25,248,413	\$ 24,725,182
2. Actuarial present value of future employee contributions - attained age	\$ 2,017,976	\$ 1,975,632
3. Actuarial present value of future contributions from other sources	N/A	N/A
4. Amount of active members' accumulated contributions	\$ 1,771,075	\$ 1,771,075
5. Actuarial present value of future salaries and future benefits at entry age	N/A	N/A
6. Actuarial present value of future employee contributions at entry age	N/A	N/A

Actuarial Impact Statement as of October 1, 2018

General Employees / Senior Management Employees

<u>Date</u>	<u>Unfunded Actuarial Accrued Liabilities</u>	<u>Current Unfunded Liabilities</u>	<u>Amortization Payment</u>	<u>Remaining Funding Period</u>
10/01/2009	Combined Bases *	\$ 1,727	\$ 180	15 years
10/01/2010	Actuarial (Gain) / Loss	202,973	17,466	22 years
10/01/2010	Assumption Changes	(109,046)	(9,383)	22 years
10/01/2011	Actuarial (Gain) / Loss	74,190	6,268	23 years
10/01/2012	Actuarial (Gain) / Loss	144,335	11,992	24 years
10/01/2012	Assumption Changes	109,052	9,061	24 years
10/01/2013	Actuarial (Gain) / Loss	77	6	25 years
10/01/2014	Actuarial (Gain) / Loss	79,239	6,392	26 years
10/01/2015	Actuarial (Gain) / Loss	139,573	11,114	27 years
10/01/2015	Assumption Changes	129,570	10,318	27 years
10/01/2015	Plan Amendment	271,565	21,625	27 years
10/01/2016	Actuarial (Gain) / Loss	282,350	22,217	28 years
10/01/2016	Assumption Changes	34,263	2,696	28 years
10/01/2017	Actuarial (Gain) / Loss	(212,997)	(16,576)	29 years
10/01/2018	Actuarial (Gain) / Loss	124,125	9,562	30 years
10/01/2018	Plan Amendment	1,432,233	110,332	30 years
	Total	\$ 2,703,229	\$ 213,270	

* Combined per Internal Revenue Code Regulation 1.412(b)-1

This Actuarial Valuation and/or cost determination was prepared and completed by us or under our direct supervision, and we acknowledge responsibility for the results. To the best of our knowledge, the results are complete and accurate, and in our opinion, the techniques and assumptions used are reasonable and meet the requirements and intent of Part VII, Chapter 112, Florida Statutes. There is no benefit or expense to be provided by the Plan and/or paid from the Plan's assets for which liabilities or current costs have not been established or otherwise provided for in the valuation. All known events or trends which may require material increase in Plan costs or required contribution rates have been taken into account in the valuation.

Jennifer Borregard

Jennifer M. Borregard, E.A.
Enrollment Number: 17-07624
Date: January 10, 2020

Michelle Jones

Shelly L. Jones, A.S.A.
Enrollment Number: 17-08684

Outline of Principal Provisions of the Retirement Plan

A. Effective Date:

January 1, 1962. Most recent amendatory Ordinance considered: 16-2392.

B. Eligibility Requirements:

All regular, full-time employees are eligible upon employment. The Town Manager and Town Attorney have the right to opt out of the Plan.

C. Creditable Service:

All service of a member measured in years and completed calendar months since latest date of hire with the Town.

D. Average Final Compensation (AFC):

The average of basic compensation during the highest three years (five years for General Employees) of the ten years preceding termination of employment; does not include bonuses, overtime, lump sum payments of unused leave or other nonregular payments.

E. Normal Retirement:

1. Eligibility:

For sworn Police Officers, the earliest of (1) age 52 with 20 years of Creditable Service, (2) age 62 with 5 years of Creditable Service, (3) completion of 25 years of Creditable Service or (4) the completion of 15 years and 4 months of service if hired on a full time basis in March 2003. For a participating Town Manager and the Town Attorney, the earlier of (1) age 62 with 15 years of Creditable Service or (2) age 64 with 7 years of Creditable Service. For all other employees, the earliest of (1) age 50 with 20 years of Creditable Service, (2) age 52 with 15 years of Creditable Service or (3) age 55 with 10 years of Creditable Service.

2. Benefit:

Period of Service	Benefit Accrual Rate per Year of Service Based on Employee Contribution Rate of			
	5%	6%	7%	8%
Before 10/1/1979	1 2/3%	N/A	N/A	N/A
10/1/1979 - 6/30/1996	1 2/3%	N/A	2.0%	N/A
7/1/1996 - 1/31/2003	1 2/3%	N/A	2.0%	2.5%
2/1/2003 - 9/30/2005	2.0%	2.5%	N/A	N/A
10/1/2005 - 9/30/2006	2.0%	2.5%	N/A	3.0% ¹
10/1/2006 - 9/30/2016	2.0%	2.5%	N/A	3.5% ¹
10/1/2016 forward	N/A	N/A	2.65% ²	2.8% ² / 3.0% ³ / 3.5% ¹

Maximum benefit is 90% (75% prior to October 1, 2006) of AFC for Police Officers, 80% (68% prior to January 1, 2020, 60% prior to October 1, 2016) of AFC for General Employees and 80% (60% prior to October 1, 2016) of AFC for Senior Management Employees.

¹ For Police Officers only.

² For General Employees only.

³ For Senior Management Employees only.

Outline of Principal Provisions of the Retirement Plan

3. Form of Payment:

Straight life annuity with guaranteed refund of Accumulated Contributions (with options available).

F. Early Retirement:

1. Eligibility:

20 years of Creditable Service regardless of age.

2. Benefit:

Same as Normal Retirement Benefit using AFC and Creditable Service as of Early Retirement Date but payable at Normal Retirement Date assuming continued employment. Alternatively, benefits may commence immediately after reduction of 0.5% for each month early.

G. Delayed Retirement:

1. Eligibility:

Retirement after Normal Retirement Date.

2. Benefit:

Calculated in the same manner as Normal Retirement Benefit using AFC and Creditable Service as of delayed retirement date.

H. Disability Retirement:

1. Service Connected:

a) Eligibility:

Total and permanent disability incurred prior to normal retirement date as a direct result of performance of service to the Town and eligible for Social Security disability benefits.

b) Benefit:

75% (if injury) or 45% (if disease) of the rate of pay in effect on date of disability payable for life or until recovery. For General Employees, less Social Security disability benefits; there is an offset for Workers' Compensation to the extent that the disability benefit plus the Workers' Compensation benefit exceed 100% of preretirement salary.

2. Non-Service Connected:

a) Eligibility:

Total and permanent disability not incurred as a direct result of performance of service to the Town.

Outline of Principal Provisions of the Retirement Plan

b) Benefit:

Accrued pension benefit.

I. Death Benefit:

1. Pre-Retirement:

Refund of Accumulated Contributions

2. After Normal Retirement Date but before Actual Retirement:

Survivor benefit payable in accordance with optional form of benefit chosen by member.

3. After Retirement:

Refund of any remaining Accumulated Contributions or optional survivor's benefits if elected.

J. Accumulated Contributions:

The sum of all amounts contributed by members including 4% interest on contributions made after January 1, 1979. Effective January 1, 2009, member contributions are *picked-up* by the Town.

K. Termination Benefit:

Upon termination prior to normal or early retirement date a member shall be entitled to choose (1) or (2) below, where:

1. A refund of Accumulated Contributions.
2. The benefit as for normal retirement using AFC and Creditable Service as of date of termination multiplied by the applicable percentage on the table below, commencing upon the earliest date a member would have attained normal retirement had he remained in service (age 65 for General Employees).

<u>Years of Creditable Service</u>	<u>Percentage</u>	
	<u>General Employees</u>	<u>Police Officers</u>
Less than 5	0%	0%
5	50%	100%
6	60%	100%
7	70%	100%
8	80%	100%
9	90%	100%
10 or more	100%	100%

3. A participating Town Manager and the Town Attorney 100% vested upon completion of 7 years of Creditable Service.

Outline of Principal Provisions of the Retirement Plan

L. Cost of Living Increase

For Police Officers and Communication Employees, a 1.5% automatic annual cost of living increase is provided for all current and future retirees, disableds, beneficiaries and vested terminated members.

For General and Senior Management retirees, disableds, beneficiaries and vested terminated members who retire before January 1, 2020, a 1.5% automatic annual cost of living increase is provided. For General and Senior Management retirees, disableds, beneficiaries and vested terminated members who retire on or after January 1, 2020, a 2.0% automatic annual cost of living increase is provided.

M. Deferred Retirement Option Program (DROP)

1. Eligibility: Attainment of normal retirement date.
2. The maximum period of participation in the DROP is five (5) years.
3. An employee's account in the DROP program shall be credited with interest based upon actual Fund investment return.
4. No payment may be made from DROP until the employee actually separates from service with the Town.

N. Changes Since Previous Actuarial Valuation

Normal Retirement was:

Eligibility:

For all other employees, the earlier of (1) age 62 with 15 years of Creditable Service or (2) age 65 with 10 years of Creditable Service.

Benefit:

Maximum benefit was 68% of AFC for General Employees (60% prior to October 1, 2016).

Early Retirement was:

Eligibility:

The earlier of (a) age 55 with 15 years of Creditable Service, or (b) 20 years of Creditable Service

Cost of Living Increases were:

A 1.5% automatic annual cost of living increase is provided for all current and future retirees, disableds, beneficiaries and vested terminated members.

Actuarial Assumptions and Actuarial Cost Methods
Used in the Valuation

A. Mortality

General Mortality Assumptions:

For healthy male participants during employment, RP 2000 Combined Male Healthy Participant Mortality Table, with 50% White Collar / 50% Blue Collar Adjustment and fully generational mortality improvements projected to each future decrement date with Scale BB. For healthy female participants during employment, RP 2000 Combined Female Healthy Participant Mortality Table, with White Collar Adjustment and fully generational mortality improvements projected to each future decrement date with Scale BB.

For healthy male participants post employment, RP 2000 Annuitant Male Mortality Table, with 50% White Collar / 50% Blue Collar Adjustment and fully generational mortality improvements projected to each future decrement date with Scale BB. For healthy female participants post employment, RP 2000 Annuitant Female Mortality Table, with White Collar Adjustment and fully generational mortality improvements projected to each future decrement date with Scale BB.

For disabled male participants, RP 2000 Disabled Male Mortality Table, setback four years, without projected mortality improvements. For disabled female participants, RP 2000 Disabled Female Mortality Table, set forward two years, without projected mortality improvements.

Sample Ages (2018)	Pre-retirement Future Life Expectancy (Years)		Post-retirement Future Life Expectancy (Years)	
	Male	Female	Male	Female
	55	30.53	33.57	30.10
60	25.60	28.54	25.44	28.44
62	23.70	26.58	23.60	26.52

Sample Ages (2038)	Pre-retirement Future Life Expectancy (Years)		Post-retirement Future Life Expectancy (Years)	
	Male	Female	Male	Female
	55	32.67	35.41	32.26
60	27.78	30.38	27.63	30.30
62	25.87	28.40	25.78	28.35

Actuarial Assumptions and Actuarial Cost Methods
Used in the Valuation

A. Mortality (cont'd)

Police Mortality Assumptions:

For healthy participants during employment, RP 2000 Combined Healthy Participant Mortality Tables, separate rates for males and females, with 90% Blue Collar Adjustment / 10% White Collar Adjustment and fully generational mortality improvements projected to each future decrement date with Scale BB.

For healthy participants post employment, RP 2000 Annuitant Mortality Tables, separate rates for males and females, with 90% Blue Collar Adjustment / 10% White Collar Adjustment and fully generational mortality improvements projected to each future decrement date with Scale BB.

For disabled male participants, 60% RP 2000 Disabled Male Mortality Table setback four years / 40% RP 2000 Annuitant Male Mortality Table, with White Collar Adjustment and no setback, without projected mortality improvements. For disabled female participants, 60% RP 2000 Disabled Female Mortality Table set forward two years / 40% RP 2000 Annuitant Female Mortality Table, with White Collar Adjustment, without projected mortality improvements.

Sample Ages (2018)	Pre-retirement Future Life Expectancy (Years)		Post-retirement Future Life Expectancy (Years)	
	Male	Female	Male	Female
	55	29.84	32.60	29.33
60	24.96	27.56	24.76	27.41
62	23.09	25.59	22.97	25.49

Sample Ages (2038)	Pre-retirement Future Life Expectancy (Years)		Post-retirement Future Life Expectancy (Years)	
	Male	Female	Male	Female
	55	32.06	34.54	31.57
60	27.21	29.49	27.03	29.36
62	25.34	27.51	25.23	27.42

Actuarial Assumptions and Actuarial Cost Methods
Used in the Valuation

B. Investment Return

7.25%, compounded annually - net of investment expenses includes inflation at 2.50%.

C. Allowances for Expenses or Contingencies

Estimated expenses for upcoming year, not including investment related expenses.

D. Employee Withdrawal Rates

Withdrawal rates for males and females were used in accordance with the following illustrative examples:

<u>General Employees</u>	
<u>Age</u>	<u>Withdrawal Rate</u>
Under 25	30.0%
25 - 29	20.0%
30 - 34	15.0%
35 - 39	10.0%
40 - 44	9.0%
45 - 49	8.0%
50 - 54	7.0%
55 - 60	6.0%
60 & over	5.0%

<u>Police Officers</u>	
<u>Service</u>	<u>Withdrawal Rate</u>
0 - 4	12.0%
5 - 6	10.0%
7	5.0%
8	2.0%
9 & over	1.0%

Actuarial Assumptions and Actuarial Cost Methods
Used in the Valuation

E. Salary Increase Factors

Current salary is assumed to increase at a rate based on the tables below - includes assumed wage inflation of 3.0%.

General Employees	
<u>Service</u>	<u>Salary Increase</u>
0 - 3	6.5%
4 - 5	6.0%
6	5.0%
7 - 9	4.5%
10 & over	4.0%

Police Officers	
<u>Service</u>	<u>Salary Increase</u>
0 - 2	8.0%
3	7.0%
4 - 5	6.0%
6	5.0%
7 & over	4.0%

F. Disability Benefits

1. Rates: See Table Below
2. Percent Service Connected: 25% for General, 80% for Police.
3. Assume 50% of Service Connected Disabilities are due to injury and 50% are due to disease.

Age	Annual Rate of Disability	
	General Employees	Police Department
20	0.07%	0.14%
30	0.11%	0.18%
40	0.19%	0.30%
50	0.51%	1.00%
60	1.66%	0.00%

Actuarial Assumptions and Actuarial Cost Methods
Used in the Valuation

G. Smoothed Actuarial Value of Assets

The method used for determining the smoothed actuarial value of assets phases in the deviation between the expected and actual return on assets at the rate of 20% per year. The smoothed actuarial value of assets will be further adjusted to the extent necessary to fall within the corridor whose lower limit is 80% of the fair market value of Plan assets and whose upper limit is 120% of the fair market value of Plan assets.

H. Assumed Retirement Age

		Annual Rate of Retirement*		
Age	General Employees	Senior Management	Age	Police Officers
Rates when the maximum benefit cap is not applicable				
40	N/A	N/A	40	3%
41-45	4%	4%	41-45	2%
46-47	3%	3%	46-47	1%
48-49	2%	2%	48-50	1%
50-64	5%	5%	51 & over	1%
65-69	50%	50%	NRA	50%
70	100%	100%	Past NRA	50%
Rates when the maximum benefit cap is applicable				
50-64	100%	35%		
65-69	100%	50%		
70	100%	100%		

100% of members are assumed to retire upon reaching age 65 for Police Officers.

* For Employees who meet the age and service eligibility requirements for normal or early retirement

I. Marriage Assumption

100% of all members are assumed to be married. Wives are assumed to be three years younger than their husbands.

J. Actuarial Funding Method

Normal Retirement, Termination, Disability, and Death Benefits: Entry-Age-Actuarial Cost Method.

Under this method the normal cost for each active employee is the amount which is calculated to be a level percentage of pay that would be required annually from his age at hire to his assumed retirement age to fund his estimated benefits, assuming the Plan has always been in effect. The normal cost for the Plan is the sum of such amounts for all employees. The actuarial accrued liability as of any valuation date for each active employee or inactive employee who is eligible to receive benefits under the Plan is the excess of the actuarial present value of estimated future benefits over the actuarial present value of current and future normal costs. The unfunded actuarial accrued liability as of any valuation date is the excess of the actuarial accrued liability over the smoothed actuarial value of assets of the Plan.

Actuarial Assumptions and Actuarial Cost Methods
Used in the Valuation

K. Change Since Previous Actuarial Valuation

Assumed Retirement Age was:

Age	Annual Rate of Retirement*	
	General Employees	Police Officers
40	N/A	3%
41-45	4%	2%
46-47	3%	1%
48-50	2%	1%
51 & over	1%	1%
NRA	40%	50%
Past NRA	50%	50%

100% of members are assumed to retire upon reaching age 70 for General Employees and age 65 for Police Officers.

* For Employees who meet the age and service eligibility requirements for normal or early retirement

Retirement Benefit Comparison for General Employees
October 2019

RETIREMENT BENEFIT	SURFSIDE	BAL HARBOUR	BAY HARBOR	MIAMI BEACH	Pension Board Proposal
<p>Normal Retirement Date (general employees)</p>	<p>* 62 birthday and 15 years of credited service; or * 65 birthday and 10 years of credited service</p>	<p>* Age 57 regardless of service; * 55 birthday and 25 years of credited service; or * 30 years of continuous service, regardless of age</p>	<p>* 52 birthday and 20 years of credited service; or * 55 birthday and 10 years of credited service; or * 65 birthday without regard to length of credited service</p>	<p>* Age 50 and 5 years of credited service (Tier A- All other members); or * Age 55 and 5 years of credited service (Tier B - AFSCME hired on or after April 30, 1993; members classified as GSA or other hired on or after August 1, 1993, members of CWA hired on or after February 21, 1994; and unclassified members hired on or after October 18, 1992) * Age 55 and 30 years of service or age 62 with 5 years of service (Tier C - All members hired on or after September 30, 2010 (October 27, 2010 for members of CWA). Benefits for employees hired on or after July 14, 2010 and prior to September 31, 2013-The normal retirement date shall be as provided in sec. 66, except that a member must complete at least five years of creditable service, and must attain age 48 to be eligible for "Rule of 70" retirement.</p>	<p>Attainment of age 50 and completion of 20 years of service; the attainment of age 52 and completion of 15 years of service; or the attainment of age 55 and the completion of 10 years of service</p>

Retirement Benefit Comparison for General Employees
October 2019

Benefit CAP	% general; 80 % Senior Management	100%	100%	90 % cap for Tier A members; 80% cap for Tier B and C members	Increase maximum benefit cap to 80%
RETIREMENT BENEFIT	SURFSIDE	BAL HARBOUR	BAY HARBOR	MIAMI BEACH	Pension Board Proposal
Current Multiplier	2.8 % general employees, and 3% senior management	3%	2.75%	3%	
Vesting Schedule	Less than 1 year of service = 0 %; 1 year of service = 10%; 2 years of service = 20%; 3 years of service = 30%; 4 years of service = 40%; 5 years of service = 50%; 6 years of service = 60%; 7 years of service = 70%; 8 years of service = 80%; 9 years of service = 90% and 10 years of service = 100 %	For members who terminate service on or after February 12, 2018 : * Less than 5 completed years of service = none * 5 completed years of service = 100%			
COLA	1.50%	2.50%		2.5 % Tier A and Tier B; 1.5% Tier C	2%

**Retirement Benefit Comparison for General Employees
October 2019**

Member Contribution	8%	8%	<p>At a minimum 2% ; General employee members desiring to increase their benefit accrual rate for membership may at their individual discretion, elect to make additional, voluntary contributions to the fund such that the total amount will be any full percentage rate from three percent to ten percent.</p>	12 % Tier A; 10% Tier B and C
----------------------------	----	----	---	-------------------------------

—

ORDINANCE NO. 2020-1707

AN ORDINANCE AMENDING CHAPTER 2, ARTICLE V, DIVISION 2 OF THE CODE OF THE TOWN OF SURFSIDE REGARDING THE RETIREMENT PLAN FOR EMPLOYEES OF THE TOWN OF SURFSIDE; AMENDING SECTION 2-176(a) OF THE TOWN CODE TO LOWER RETIREMENT AGES FOR NON-PUBLIC SAFETY EMPLOYEES CONSISTENT WITH MAXIMUM BENEFIT LIMITATIONS; AMENDING SECTION 2-176(c) OF THE TOWN CODE TO INCREASE THE MAXIMUM BENEFIT LIMITATION FROM 68% TO 80% FOR GENERAL EMPLOYEES; AMENDING SECTION 2-192 OF THE TOWN CODE TO INCREASE THE COST OF LIVING ADJUSTMENT FROM 1.5% TO 2% PER YEAR FOR NON-PUBLIC SAFETY EMPLOYEES; PROVIDING FOR SEVERABILITY; PROVIDING FOR CODIFICATION; AND PROVIDING AN EFFECTIVE DATE.

WHEREAS, the Town of Surfside sponsors a defined benefit retirement plan for employees of the Town of Surfside (“Retirement Plan”);

WHEREAS, the Board of Trustees of the Retirement Plan, after a review of benefits in surrounding cities, has recommended enhancing pension benefits to align retirement ages with the Retirement Plan’s maximum benefit limitation (hereinafter the “benefit cap”);

WHEREAS, general employees currently contribute 8% of pensionable earnings;

WHEREAS, the maximum benefit cap for general employees is currently 68% for general employees and 80% for management employees;

WHEREAS, approximately 63% of general employees reach the maximum benefit cap of 68% before they are eligible to retire;

WHEREAS, notwithstanding the pension cost, there are anticipated to be savings from a recruitment standpoint, by reducing turnover and making the Retirement Plan more competitive with surrounding cities;

WHEREAS, the Commission of the Town of Surfside believes that the adoption of this amendment is in the best interests of the citizens and taxpayers of the Town;

NOW, THEREFORE, BE IT ORDAINED by the Town Commission of the Town of Surfside:

Section 1. SECTION 2-176(a), Service Retirement Allowance, is hereby amended and to be read as follows:

Sec. 2-176. Service Retirement Allowance.

- (a) Normal retirement date. Each member who retires or otherwise terminates employment with the town on or after his normal retirement date, as determined below, shall be entitled to receive a service retirement annuity in the amount provided in subsection (c) of this section. Effective ~~October 1, 1984~~ January 1, 2020, the normal retirement date for each member shall be the first day of the month coincident with or next following the earlier of:

- (2) For members who are not sworn law enforcement officers, the earliest of:
- a. ~~The attainment of age 62 and the completion of 15 years of creditable service; or~~
 - b. ~~The attainment of age 65 and the completion of ten years of creditable service.~~
 - a. The attainment of age fifty (50) and completion of twenty (20) years of service;
 - b. The attainment of age fifty-two (52) and completion of fifteen (15) years of service; or
 - c. The attainment of age fifty-five (55) and completion of ten (10) years of service.

Section 2. SECTION 2-176(c), Service Retirement Allowance, is hereby amended and to be read as follows:

Sec. 2-176. Service Retirement Allowance.

- (c) Computation of annuity:
- (1) For members who are not police officers, the amount of monthly retirement annuity with respect to all creditable service rendered by each member prior to October 1, 1979, shall be equal to 1 2/3 percent of the monthly average final compensation multiplied by the number of years of creditable service rendered

prior to October 1, 1979. For each employee who contributes at the rate of five percent of earnable compensation on and after January 1, 1980, the amount of monthly retirement annuity with respect to creditable service rendered after September 30, 1979, shall be equal to $1\frac{2}{3}$ percent of the monthly average final compensation multiplied by the number of years of creditable service rendered after September 30, 1979. For each employee who contributes at the rate of seven percent of earnable compensation on and after January 1, 1980, the amount of monthly retirement annuity with respect to creditable service rendered after September 30, 1979, shall be equal to two percent of the monthly average final compensation multiplied by the number of years of creditable service rendered after September 30, 1979. For each member who contributes at the rate of eight percent of earnable compensation after June 30, 1996, the amount of monthly retirement annuity with respect to creditable service rendered after June 30, 1996, shall be equal to two and one-half percent of monthly average final compensation multiplied by the number of years of creditable service rendered after June 30, 1996. For each member who elects as of July 1, 1996 to increase his contribution from five percent to seven percent of earnable compensation, the amount of retirement annuity with respect to creditable service rendered after June 30, 1996, shall be equal to two percent of monthly average final compensation multiplied by the number of years of creditable service rendered after June 30, 1996. For each member who elects as of July 1, 1996 to increase his contribution rate to seven percent or eight percent of earnable compensation, the amount of retirement annuity with respect to creditable service rendered after September 30, 1979 but before July 1, 1996 shall be equal to one and two-thirds percent, if prior to July 1, 1996 he had been contributing at the rate of five percent, or two percent, if prior to July 1, 1996 he had been contributing at the rate of seven percent, of monthly average final compensation multiplied by the number of years of creditable service rendered after September 30, 1979 but prior to July 1, 1996. The foregoing election periods shall expire on July 31, 1996 and may not be extended for any reason. For each member who contributes at the rate of five percent of earnable compensation on and after February 1, 2003, the amount of monthly retirement annuity with respect to creditable service rendered on and after February 1, 2003 shall be equal to two percent of the monthly average final compensation multiplied by the number of years of creditable service rendered on and after February 1, 2003. For each member who contributes at the rate of six percent of earnable compensation on and after February 1, 2003, the amount of monthly retirement annuity with respect to creditable service rendered on and after February 1, 2003 shall be equal to two and one-half percent of the monthly average final compensation multiplied by the number of years of creditable service rendered on and after February 1, 2003. In no event shall the total annuity as computed above for any member exceed 60 percent of the monthly average final compensation.

For members who are not police officers or senior management employees, effective October 1, 2016:

- (i) For each member who contributes at the rate of eight percent (8%) of earnable compensation, the amount of monthly retirement annuity with respect to creditable service rendered on and after October 1, 2016 shall be equal to two and eight-tenths percent (2.8%) of monthly average final compensation multiplied by the number of years of creditable service rendered on and after October 1, 2016;
- (ii) For the member who contributes at the rate of seven percent (7%) of earnable compensation, the amount of monthly retirement annuity with respect to creditable service rendered on and after October 1, 2016 shall be equal to two and sixty-five one hundredths percent (2.65%) of monthly average final compensation multiplied by the number of years of creditable service rendered on and after October 1, 2016; and
- (iii) In no event shall the total annuity as computed above for any member exceed ~~sixty-eight~~ eighty percent (68% 80%) of monthly average final compensation, effective January 1, 2020.

Section 3. SECTION 2-192, Cost-of-living adjustment for retired members and their beneficiaries, is hereby amended and to be read as follows:

Sec. 2-192. - Cost-of-living adjustment for retired members and their beneficiaries.

- (a) The purpose of this section is to provide a cost-of-living adjustment to the benefits payable to retired members on or after January 1, 2004 and their beneficiaries.
- (b) Commencing on the first day of January, 2004 and on the first day of each January thereafter, the benefit of each retired member or beneficiary shall be adjusted as follows:
 - (1) The amount of the monthly benefit payable for the 12-month period commencing on the first adjustment date shall be the amount of the monthly benefit plus one and one-half percent. The amount of the monthly benefit payable for subsequent twelve-month periods shall be the amount of the monthly benefit being received on January 1 immediately preceding the adjustment date plus an amount equal to one and one-half percent of said benefit. Effective January 1, 2020, the cost of living benefit shall be two percent (2%) for all members who retire on or after January 1, 2020.

Section 4. All sections or parts of sections of the Town Code, all ordinances or parts of ordinances, and all resolutions or parts of resolutions in conflict herewith, be and the same, are hereby repealed to the extent of such conflict.

Section 5. Should this ordinance or any part thereof be declared invalid by a Court of competent jurisdiction, the invalidity of any part of this ordinance shall not otherwise affect the validity of the remaining provisions of this ordinance, which shall be deemed to have been enacted without the invalid provision.

Section 6. It is the intention of the Commission of the Town of Surfside that the provisions of this ordinance shall become and be made a part of the Code of the Town of Surfside, and that the word "ordinance" may be changed to "section," "article," or such other appropriate word or phrase in order to accomplish such intentions.

Section 7. This ordinance shall become effective upon final passage.

PASSED AND ADOPTED ON FIRST READING, this 10th day of December, 2019 with a 5-0 vote.

PASSED AND ADOPTED ON SECOND READING, this 14th day of January, 2020 with a 5-0 vote.



Daniel Dietch, Mayor

ATTEST:

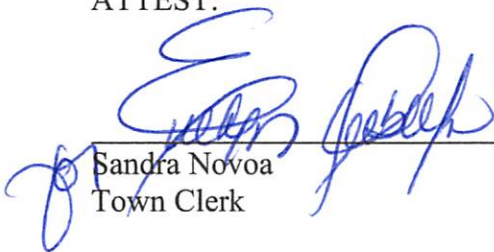

Sandra Novoa
Town Clerk

**APPROVED AS TO FORM AND
LEGAL SUFFICIENCY**

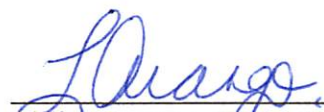

Lillian Arango, Town Attorney

Moved by: Commissioner Karukin

Second by: Commissioner Paul



MEMORANDUM

To: Honorable Mayor, Vice-Mayor and Members of the Town Commission
From: Guillermo Olmedillo, Town Manager
Date: April 20, 2020
Subject: Retirement Plan Funding Ratio

Pursuant to Town Commission's direction at the April 16, 2020 Town Commission meeting regarding the Retirement Plan Funding Ratio, the following information reviews the Funding Ratio comparison:

In 2012, the mortality assumption was updated, this led to a decrease in the Funded Ratio of approximately 0.7%.

In 2013, the Funded Ratio, as reported under GASB, was changed to be the Market Value of Assets divided by the trailing Liability (the liability a year before the actual reporting date) – however, the Funded Ratio below is a Funded Ratio Calculation that our actuarial firm, Gabriel Roeder Smith (GRS) prepared so that a comparison could be made. Using the actuarial report assures an independent statement. (Please note that the Actuarial Value of Assets is a five-year smoothed asset value).

You will notice that from 2008 to 2012 the Funded Ratio decreased 17.3%. From 2012 to 2018 a relatively steady Funded Ratio was maintained.

The main reason for the decrease in Funded Ratio from 2008 to 2012 was the Great Recession. Additionally, the smoothing used in the Asset Value in the Funded Ratio, the impact of the Great Recession on the asset value was not fully reflected out until 5 years after the crisis.

Other factors include:

In 2015, the mortality table was updated, pursuant to Florida Statute, and the investment return assumption was lowered from 7.50% to 7.25% (along with other demographic assumption changes after an experience study was performed). This decreased the Funded Ratio by 1.9%.



Writer's email: adam@robertdklausner.com

Via email: abraham.issa@ubs.com

Abraham Issa, Chairman
Surfside Employees Retirement Plan
c/o Plan Administrator

Mr. Chairman,

This is in response to your request for a legal opinion as to whether the payment of pension benefits is a ministerial duty required as a matter of law. That question is answered in the affirmative. The Board's fiduciary duty to pay benefits when a member has achieved retirement eligibility arises under both state statute and common law.

For nearly a century, courts have held that pension rights in a governmental retirement system are not a mere gratuity. *See Stringer v. Lee*, 2 So. 2d 127 (Fla. 1941). In other words, the rights of governmental employees to timely payment of their pensions is a constitutionally protected contractual right. Once vested in the retirement system by achieving eligibility for retirement as defined in the Plan, benefits cannot be diminished or impaired.

For the reasons described below, were the Board to refuse to comply with the payment obligations set forth in the Plan, retirees would have the right to bring suit for "mandamus" which is a mandatory injunction to compel the Board to abide by its "ministerial" duties.

Article I, Section 10, of the Florida Constitution - and Article I, Section 10 of the United States Constitution - prohibit laws impairing the obligation of contract. In 1933, the Florida Supreme Court concluded the such constitutional protections extend to pension contracts created

7080 NORTHWEST 4TH STREET, PLANTATION, FLORIDA 33317
PHONE: (954) 916-1202 – FAX: (954) 916-1232
www.klausnerkaufman.com

by state and municipal pension statutes and ordinances alike. *See Anders v. Nicholson*, 150 So. 639 (Fla. 1933).

In *State ex rel. Stringer v. Lee*, 2 So. 2d 127 (Fla. 1941) the Florida Supreme Court recognized that “retirement pay is a part of the compensation for services rendered during active employment.” According to the *Stringer* court, once fully vested, a governmental pension establishes a contractual relation which may not be affected or adversely altered by subsequent enactments. In 1956, the Court reasoned that public pensions “raise the standard of government personnel and make government service a career rather than a passing interlude.” *See Greene v. Gray*, 87 So. 2d 504 (Fla. 1956)(holding that public pension are required to be permissively construed).

The law is also clear that the payment of monthly pension benefits is a ministerial duty. *See Scott v. Williams*, 107 So.3d 379 (Fla. 2013); *City of Jacksonville Beach v. O’Donald*, 151 So.2d 430 (Fla. 1963); *O’Connell v. Dept. of Administration*, 557 So. 2d 609 (Fla. 3d DCA 1990). A ministerial duty arises where “there is no room for the exercise of discretion, and the performance being requested is directed by law.” *Board of County Commissioners v. Lori Parrish*, 154 So. 3d 412 (Fla. 4th DCA 2014).

Feel free to advise if you want to discuss any of the legal authorities cited, copies of which will be provided upon request.

Very truly yours,

/s/ Robert D. Klausner
Robert D. Klausner

/s/ Adam P. Levinson
Adam P. Levinson

RD/APL/yv

cc: Mayte Gamiotea, Administrator



MEMORANDUM

ITEM NO.9X

To: Honorable Mayor, Vice-Mayor and Members of the Town Commission
From: Guillermo Olmedillo, Town Manager
Date: June 23, 2020
Subject: Increase Lighting Plan

At the March 24, 2020 Special Commission Meeting, Town Administration was directed to provide a plan for the increase of residential street lighting.

Please find attached requested report being provided with this communication.

Reviewed by: HG/RS

Prepared by: HG



Town of Surfside Public Works Department Safer Walkability- Increased Lighting Plan

Update as of March 30th, 2020

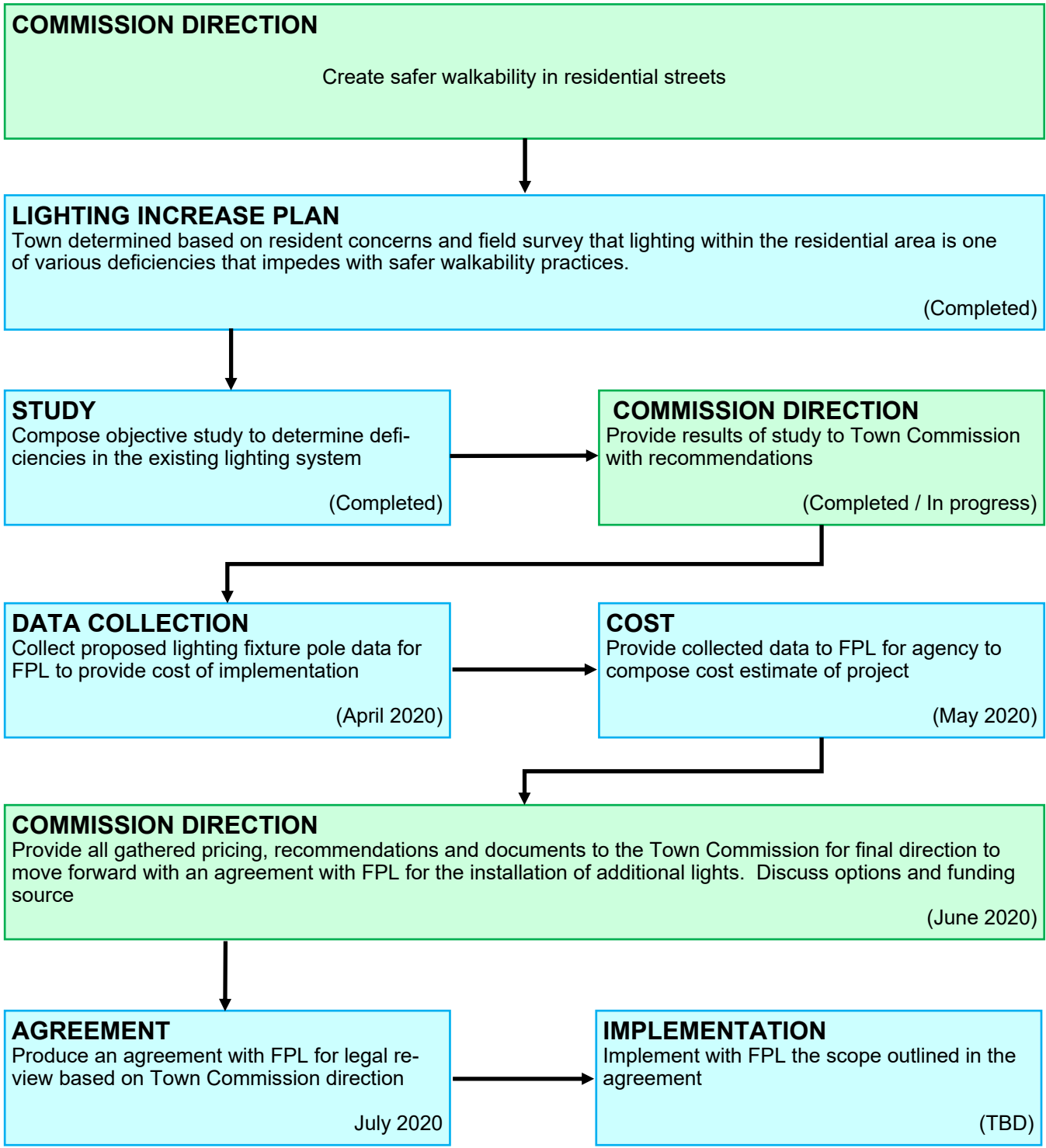



MEMORANDUM

ITEM NO.

To: Honorable Mayor, Vice-Mayor and Members of the Town Commission

From: Guillermo Olmedillo, Town Manager

Date: February 28th, 2020

Subject: Analysis for Determination of Additional Lighting Locations in Residential Areas within the Town of Surfside

The Town of Surfside, in an effort to address pedestrian safety and promote walkability within the Town, recently partnered with Florida Power and Light (FPL) to upgrade all residential street lighting from high pressure sodium bulbs to Light Emitting Diodes (LED). The lighting upgrade project was completed in January 2020 with a total of 236 fixtures changed. After the conversion, the Public Works Department performed various nightly walkthroughs to evaluate the outcome of the conversion. As a result, a 33% increase in illumination per fixture was obtained. This determination was made by comparison of photometrics of both the new LED lighting and high-pressure sodium bulbs. Photometrics is the measurement of lighting. For the comparisons made, photometric data used was the surface coverage of lighting onto asphalt surface from both fixtures, before and after conversion.

Illumination is not uniform throughout the Town. Even after the FPL conversion project, various “dark” areas exist that continue to remain a hazard. The Town administration will proceed to perform an analysis on illumination deficiencies still present. In order to eliminate subjectivity in the determination of the location and number of new light fixtures and or poles to have uniform illumination at the pedestrian level, the Town administration will prepare an analysis that incorporates the following:

1. Use the technical specifications of the equipment in place already obtained from FPL.
2. Use the information that the Town has already collected on the location of light fixtures including previous lighting data.
3. Draw the area illuminated from each lighting fixture, using the technical specifications already obtained.
4. Produce a map (GIS or similar) with the proposed locations of new lights and or poles.

5. Propose a plan to add lights where pedestrian level lighting does not have uniform illumination and deficiencies determined

The proposed plan allows for a non-subjective determination of areas in need of additional lighting. The proposed plan will provide hazard areas based on existing and collected data. An alternative plan to have individuals estimate where additional illumination should go based on visual interpretation can lead to subjective results. The Town administration will move forward with the presented plan of analysis as per Town Commission direction. The results will be reported to the Town Commission through an update.

Reviewed by

Prepared by

TOWN OF SURFSIDE

Public Works Department

“Residential Street Lighting Photometric Analysis and Recommendations”

February 26, 2020

9293 HARDING AVENUE,
SURFSIDE, FL 33154
PHONE: (305) 861-4863

Prepared By:



Public Works Department



TABLE OF CONTENTS

INTRODUCTION	3
OBJECTIVE	4
METHODOLOY	5
ANALYSIS	6
RECOMMENDATION AND CONCLUSION	15

ATTACHMENTS

- Appendix A – *“Town of Surfside Street Light Inventory”*- 1 Page
- Appendix B – *“Product Specification Photometrics”*- 3 Pages
- Appendix C – *“Street Light Photometric”* - 2 Pages
- Appendix D – *“Proposed Street Lights Map”*. - 1 Page



INTRODUCTION

The Town of Surfside is a coastal community within Miami-Dade County with approximately 5,844 residents based on 2017 population figures. The Town has various districts which include commercial high-rise, commercial retail and residential single family. Each of these districts has lighting infrastructure provided by different agencies. **Table A – “Lighting Inventory by Responsible Authority”** below outlines the total quantity of light fixtures per district and the responsible party for lighting maintenance:

Item Number	District	Responsible Party	Total # of Fixtures	Type of Fixture
1	Residential	FP&L	243	LED
2	Downtown Surfside	Town of Surfside	24	LED
3	A1A & Harding Ave	Miami-Dade County	62	High Pressure Sodium
4	Beach Ends	FP&L / Town of Surfside	11	HPS and LED

Table A – “Lighting Inventory by Responsible Authority”

Table A – “Lighting Inventory by Responsible Authority” is composed based on a Geographical Information System (GIS) mapping composed in 2018 by Town Engineer of Record (EOR), Calvin Giordano and Associates (CGA) and confirmed by the Town’s Public Works Department. The GIS map titled “Town of Surfside Street Light Inventory” can be found in **Appendix A – “Town of Surfside Street Light Inventory”**.

In late 2019, the Town of Surfside Commission approved the conversion of High-Pressure Sodium lights (HSP) throughout the residential area to Light Emitting Diode (LED) with the objective of minimizing operating costs for night-time illumination of public right of way and increase effectiveness of illumination. The lighting upgrade project was completed in January 2020 with a total of 236 fixtures changed. After the conversion, the Public Works Department performed various nightly walkthroughs to evaluate the outcome of the conversion. As a result, a 33% increase in illumination per fixture was obtained. This determination was made by comparison of photometrics of both the new LED lighting and high-pressure sodium bulbs. Photometrics is the measurement of lighting. For the comparisons made, photometric data used was the surface coverage of lighting onto asphalt surface from both fixtures, before and after conversion. The photometrics of the previous high sodium pressure bulbs (HPS) and recently installed LED fixtures can be found in **Appendix B – “Product Specification Photometrics”**.

Currently, Florida Department of Transportation (FDOT) is working with Miami-Dade County (MDC) and is scheduled to convert a portion of street lights on A1A and Harding Avenue for fiscal year 2021-2022 to LED. Additionally, the Town of Surfside converted all Town maintained street lights to LED already. During the February 2020 Town Commission meeting, the Town Commission gave direction to the Town Manager to proceed with performing a street lighting analysis in order to determine where additional lights are needed.



OBJECTIVE

Increase the quantity of residential street lighting fixtures with locations non-subjectively selected with the purpose to create safer walkability by increasing illumination during evening hours.

Illumination is not uniform throughout the Town. Even after the conversion project within the residential area, various “dark” areas exist that continue to remain a hazard for walkability during night-time hours. **Picture A** – “*Photograph of Dickens Avenue and 92nd street*” below shows the composition of dark areas and light areas as they pertain to a residential street block within the Town.



Picture A – “*Photograph of Dickens Avenue and 92nd street*”

The Town Administration performed an analysis based on information gathered and field visits in order to increase the quantity of residential street lighting fixtures with locations non-subjectively selected with the purpose of creating safer walkability by increasing illumination



during evening hours. Furthermore, a **Recommendation and Conclusion** section is provided in this analysis report to assist with Town Commission direction decision.

METHODOLOGY

In order to eliminate subjectivity in the determination of the location and number of new light fixtures to have uniform illumination at the pedestrian level, the analysis by Town administration incorporated the following items:

- Use the technical specifications of the equipment in place already obtained from FPL. This involved the comparison of photometric charts of both HPS bulbs and LED fixtures which are included in **Appendix B** – *“Product Specification Photometric”*.
- Use the information that the Town has already collected on the location of light fixtures including previous lighting data in order to overlay photometric chart data onto existing GIS maps provided in **Appendix A** – *“Town of Surfside Street Light Inventory”*.
- Draw the area illuminated from each lighting fixture, using the technical specifications already obtained onto in **Appendix A** – *“Town of Surfside Street Light Inventory”* in order to create **Appendix C** – *“Street Light Photometric”*.
- Produce a map (GIS or similar) with the proposed locations of new lights and or poles after item number 1, item number 2 and item number 3 have been evaluated. **Appendix D** – *“Proposed Street Lights Map”*.

Based on the findings, **Table C** – *“Recommendation Table”* was composed which incorporates the findings of the analysis and makes various illumination goals depending on the number of lighting fixtures proposed. This analysis does not include cost figures or cost estimates.



ANALYSIS

The analysis for residential street light photometric is provided in this section. The analysis is based on the proposed methodology that was presented to the Town Commission during the February 2020 Town Commission General Meeting.

Use the technical specifications of the equipment in place already obtained from FPL. This involved the comparison of photometric charts of both HPS bulbs and LED fixtures which are included in **Appendix B – “Product Specification Photometrics”**.

Both photometric data for high pressure sodium bulbs and LED fixtures were compared side by side. Two distances were obtained for each lighting system; these are the longitudinal distance and width distance. Longitudinal distance is referring to the distance on each side of the fixture and width distance is the distance in front of the fixture. Both distances vary depending on the height of the fixture installation. Based on the information gathered from product specification photometrics, **Table B – “Lighting Coverage by Fixture”** below was composed to present findings.

Item Number	Type of Fixture	Longitudinal Distance (Feet)	Width Distance (Feet)	Finding Source
1	High Pressure Sodium	50	40	Field Measurement
2	High Pressure Sodium	70	50	Specification Sheet
3	LED	85	40	Field Measurement
4	LED	75	20	Specification Sheet

Table B – “Lighting Coverage by Fixture”

Table B – “Lighting Coverage by Fixture” also presents field measurements of each fixture as there was a difference in field conditions to product specification conditions. The difference was the height of installation. The Town of Surfside has fixtures installed higher than presented in product specification by a total of 5 feet with a margin of error of 3 feet. Based on findings, an average of both measurements was taken and presented in **Table C – “Lighting Coverage by Fixture Average”** as shown below:

Item Number	Type of Fixture	Longitudinal Distance (Feet)	Width Distance (Feet)	Finding Source
1	High Pressure Sodium	60	45	Average
2	LED	80	30	Average

Table C – “Lighting Coverage by Fixture Average”



It is worth noting that the figures present are the effective lighting of each light based on their design intent. Each fixture covers areas greater than shown in **Table B** – “*Lighting Coverage by Fixture*” but these areas are dimmer and not effective lighting areas. Secondly, **Appendix B** – “*Product Specification Photometrics*” provides photometrics in a disformed shape which resembles a dis-figured circle. For the purpose of this analysis, the photometric impact area was averaged and converted to a defined semi-circle. **Picture B** – “*Photometric Impact Area*” below presents the averaged fixture coverage area that was used for the analysis.

DIMENSIONS

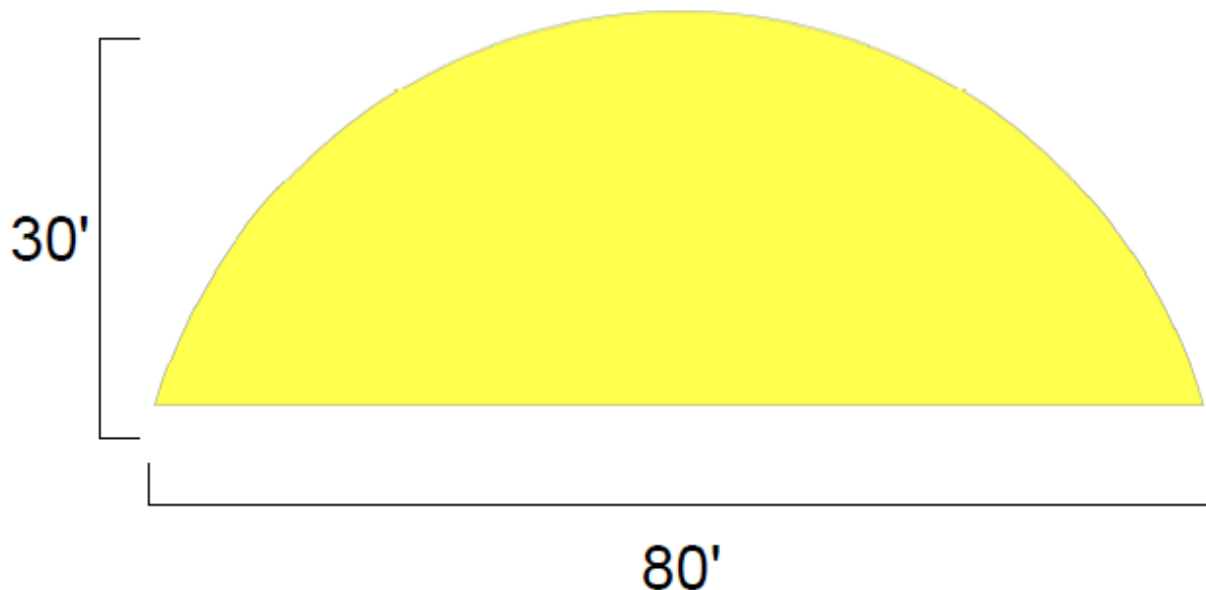

Picture B – “*Photometric Impact Area*”

Picture B – “*Photometric Impact Area*” will be referred to as the illumination zone for the remainder of the analysis. It was used as an overlay onto residential street maps in order to determine areas that are not receiving effective illumination coverage. Furthermore, there is a 6-foot to 8-foot offset from above ground utility poles to light fixture (light source) which is due to the arm length of each lighting fixture. This distance was taken into consideration. Lastly, non-effective lighting behind each lighting fixture was not taken into account. This is because these areas are not considered walkable areas and are of private property majority. Additionally, measurements of these areas illumination by LED lighting fixtures is difficult due to private property lighting distortion.



Use the information that the Town has already collected on the location of light fixtures including previous lighting data in order to overlay photometric chart data onto existing GIS maps provided in **Appendix A** – “Town of Surfside Street Light Inventory”. Draw the area illuminated from each lighting fixture, using the technical specifications already obtained onto in **Appendix A** – “Town of Surfside Street Light Inventory” in order to create **Appendix C** – “Street Light Photometric”.

Appendix A – “Town of Surfside Street Light Inventory” was used to assess the areas currently obtaining illumination and compared to the areas not receiving. Based on findings, there are currently an average of 3.00 lighting fixtures per block. Page 2 of **Appendix A** – “Town of Surfside Street Light Inventory”, lays out a typical section of a Town block. A Town block from street to street along the same avenue in the residential area is approximately 525 linear feet. Based on the average amount of lights, a total of 240 linear feet out of the entire 525 linear feet of a typical block has illumination. Therefore, it was determined that the average lighting per typical block is approximately 45%. **Diagram A** – “Typical Lighting Per Block Diagram”, below creates a visual representation of the 45% illumination of an average typical roadway.



Diagram A – “Typical Lighting Per Block Diagram”

In **Diagram A** – “Typical Lighting Per Block Diagram”, the entire strip represents a typical block along an avenue from street to street. For example, Garland Ave from 89th Street to 90th Street. The yellow sections represent the illumination zone. The black sections represent the areas where minimal to no illumination is present. Since this is an average representation of actual field conditions, it has been simplified for analysis purposes. As previously stated, even though the average coverage per existing LED fixture is 40 feet each way (80 feet total), the fading effect of each fixture may add additional coverage. The fading effect is the dimming of the illumination as the distance from the point of origin increases. The fading effect distance was not used in the analysis because it is not considered optimal illumination. The following pictures provide a reality perspective to **Diagram A** – “Typical Lighting Per Block Diagram”.



Picture C – *“Town of Surfside Night-time Aerial on 02-21-2020”*



Picture D – *“Town of Surfside Night-time Aerial on 02-21-2020 “*



Produce a map (GIS or similar) with the proposed locations of new lights and or poles after item number 1, item number 2 and item number 3 have been evaluated. **Appendix D** – “Proposed Street Lights Map”.

Propose a plan to add lights where pedestrian level lighting does not have uniform illumination and deficiencies determined.

During the evaluation of all information, it was determined that 45% of the single-family residential areas right of way within the Town are illuminated. This is based on the lighting illumination per street as an average. Prior to determining locations of additional lights, various variables needed to be considered. The considerations are as follows:

- Number of existing above ground utility poles existing
- Number of existing above ground utility poles with transformers
 - a. Accessibility to transformers if a proposed pole does not have one
 - b. Capacity of transformer
- Location of street where poles are located and if cross alternation can take place (each side of the street)
- Illumination percentage goal

45% existing illumination was based on 3 lighting fixtures per block average. In order to increase illumination, new lighting fixtures need to be added. The current infrastructure allows for additional lighting fixtures since poles either have a transformer or, are within the proximity of a pole with a transformer. To be within the proximity, the nearest pole with transformer needs to be within 2 poles distance. The current lighting fixture spread alternates with every other pole having a fixture. On average, a residential block has 6 poles and 2 transformers.

Based on two neighborhoods surveyed with optimal lighting, 90% illumination was the targeted percentage goal. 90% allows for illumination visibility throughout as lighting transition from one lighting fixture to the next. The 2 neighborhoods surveyed had the same single-family residential style as Town of Surfside. The neighborhoods were as follows:

- North Bay Village – Single Family Residential Area
- Normandy Isle, Miami Beach Single Family Residential Area

Appendix D – “Proposed Street Lights Map” proposes a total of 133 new fixtures along street blocks in the residential area in order to achieve 90% illumination. This figure breaks



down to an additional 3 fixtures per Town block. In the creation of **Appendix D** – “Proposed Street Lights Map”, some Town blocks have proposed 2 additional lighting fixtures and other more than 3 additional lighting fixtures. Even though the average is 3 additional light fixtures per block, some have proposed less since there is an intersection pole that provides block illumination. All proposed locations have an existing pole so only fixture and connection to a transformer are needed. For the most part, all transformers have the capacity for additional lighting fixture. Transformer capacities need to be confirmed with FP&L. The following pictures show areas within Miami-Dade County (MDC) with 90% illumination. The same logic for determination of light percentage in Town of Surfside as used to determine illumination percentages in these areas.



Picture E – “North Bay Village Night-time Aerial on 02-21-2020”



Picture F – “Normandy Isles Night-time Aerial on 02-21-2020”



Picture G – *“Normandy Isles Night-time Aerial on 02-21-2020”*



RECOMMENDATION AND CONCLUSION

The analysis was based on 90% illumination which is the maximum number of lighting fixtures to existing poles. **Table C** – “*Recommendation Table*” presents the number of additional fixtures with respective illumination percentage for various options. Refer to table below:

Item number	Number of Additional Lights (Overall)	Average Additional Lights per Block	Illumination Percentage	Comments
1	0	3	45%	No Change
2	89	4	60%	N/A
3	112	5	76%	N/A
4	133	6	90%	Appendix D

Table C – “*Recommendation Table*”

At this time, there is no cost estimate for each of the recommendations of **Table C** – “*Recommendation Table*”. Cost estimate will involve coordination with Florida Power and Light (FP&L). Currently, the provided recommendations are based on using existing pole infrastructure. Based on Town Commission direction, a cost estimate can be composed for proposed recommendation options. Any cost estimates pertaining to light fixtures operated by another agency need to be coordinated. In this case, cost estimate needs to be coordinated with Florida Power and Light (FPL).

Some additional considerations include:

- How will additional lighting fixtures in the Right of Way impact the quality of life of residents.
 - Light infiltration into private property
- Other options for increase walkability safety
 - Mid-level pedestrian lighting options
 - Alternative walking options such as sidewalks
 - Enhancing other infrastructure options such as;
 - Thermoplastic striping of roadway markings
 - Roadway Lighting options which include ground and signage lighting

This report was composed using the existing infrastructure present to add additional lighting fixtures to gain an increase in illumination percentage. The proposed locations of the lighting fixtures were based on existing locations of above ground utility poles.



Appendix A

“Town of Surfside Street Light Inventory”

1 Page

Legend

 City Boundary

 Parcels

Owner

 Surfside

 FPL

 Miami-Dade County



Town of Surfside Street Light Inventory

Print Date: 11/7/2018

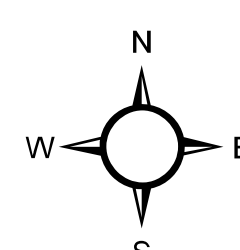

0 400 Feet



Produced and maintained by the CGA
Geographic Information Systems Services



Calvin, Giordano & Associates, Inc.
EXCEPTIONAL SOLUTIONS™



Appendix B

“Product Specification Photometric”

3 Pages

Photometric Data

E-17 High Pressure Sodium

BK No.	Lamp Watts	Description	Rated Life	Initial Lumens	Mean Lumens	CRI	CCT(K)
112	35	35W/E-17/HPS/MED/Clear	24,000	2,250	2,025	20	2,100
113	35	35W/E-17/HPS/MED/Diffuse	24,000	2,150	1,935	20	2,100
104	50	50W/E-17/HPS/MED/Clear	24,000	4,000	3,600	21	2,100
105	50	50W/E-17/HPS/MED/Diffuse	24,000	3,800	3,420	21	2,100
108	70	70W/E-17/HPS/MED/Clear	24,000	6,300	5,670	21	2,100
109	70	70W/E-17/HPS/MED/Diffuse	24,000	5,860	5,270	21	2,100
120	100	100W/E-17/HPS/MED/Clear	24,000	9,500	8,550	21	2,100
121	100	100W/E-17/HPS/MED/Diffuse	24,000	8,800	7,920	21	2,100
122	150	150W/E-17/HPS/MED/Clear	24,000	16,000	14,400	21	2,100
123	150	150W/E-17/HPS/MED/Diffuse	24,000	15,000	13,500	21	2,100

Lumen & Candela Conversion Multipliers	
100W	.60
70W	.40
50W	.25
35W	.14

NARROW SPOT

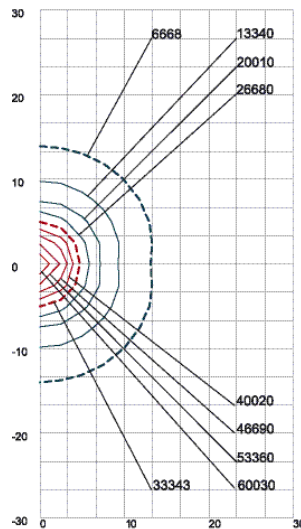

B-K FILENAME : TY11-150-NS-HPS CLEAR-ITLIES
 Lamp: 150W Clear B-17 High Pressure Sodium
 IES Beam Type: 24 x 2V
 Max. Candela: 6668 at 0°H 0°V
 Beam Spread (at 50% Max CD): 33343 at 10°H 10°V
 Field Spread (at 10% Max CD): 6668 at 28°H 28°V
 Total Lumens: 3237

SPOT

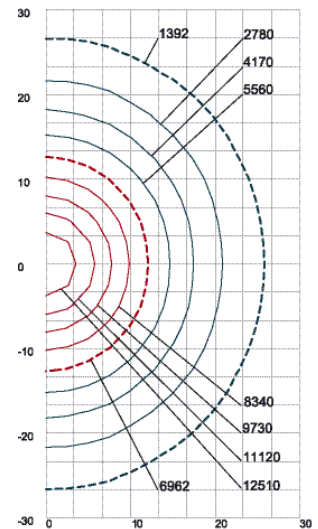

B-K FILENAME : TY11-150-SP SPECULAR-HPS CLEAR-ITLIES
 Lamp: 150W Diffuse B-17 High Pressure Sodium
 IES Beam Type: 44 x 4V
 Max. Candela: 1392 at 0°H 0°V
 Beam Spread (at 50% Max CD): 6962 at 24°H 26°V
 Field Spread (at 10% Max CD): 1392 at 51°H 53°V
 Total Lumens: 3689

FLOOD

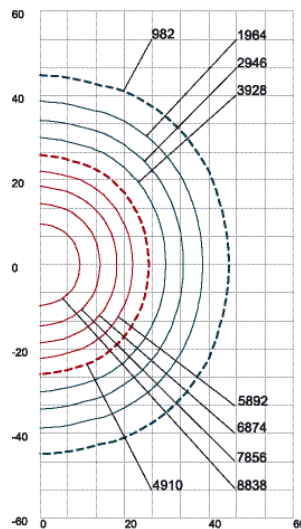

B-K FILENAME : TY11-150-FL-HPS COATED-ITLIES
 Lamp: 150W Diffuse B-17 High Pressure Sodium
 IES Beam Type: 54 x 5V
 Max. Candela: 982 at 0°H 0°V
 Beam Spread (at 50% Max CD): 4910 at 52°H 52°V
 Field Spread (at 10% Max CD): 982 at 90°H 90°V
 Total Lumens: 3237

WIDE FLOOD

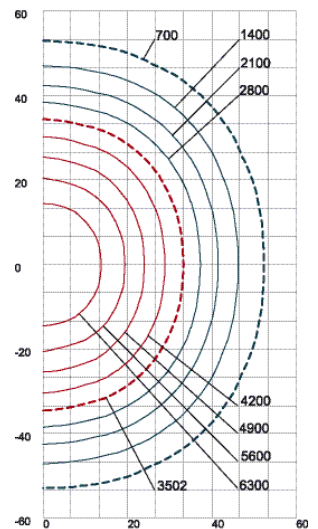

B-K FILENAME : TY11-150-WF-HPS COATED-ITLIES
 Lamp: 150W Diffuse B-17 High Pressure Sodium
 IES Beam Type: 84 x 6V
 Max. Candela: 700 at 0°H 0°V
 Beam Spread (at 50% Max CD): 3502 at 67°H 66°V
 Field Spread (at 10% Max CD): 700 at 105°H 106°V
 Total Lumens: 8569

Photometric Toolbox

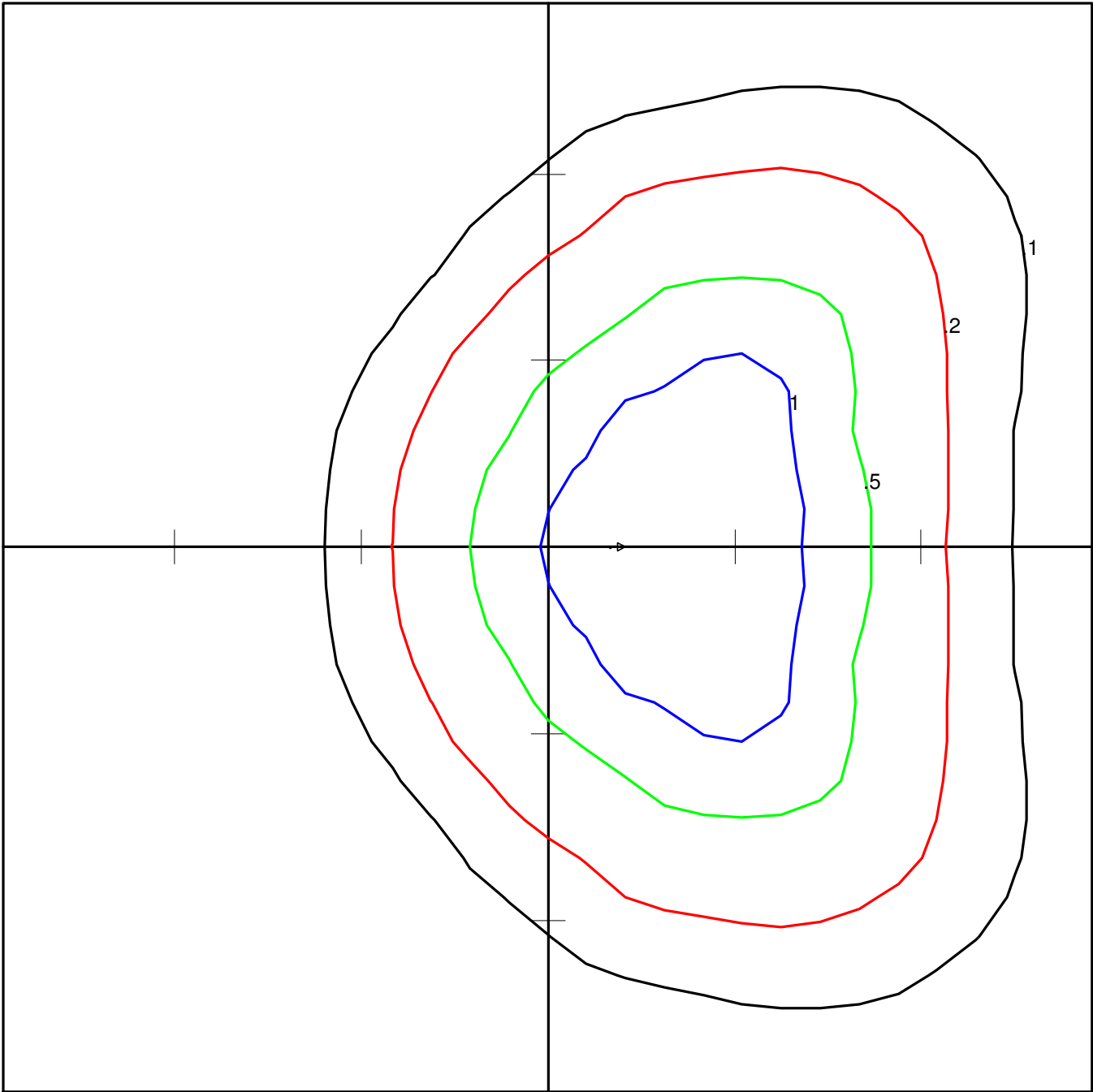

Cree, Inc
 RSWS-A-HT-3ME-5L-30K7-UL-xxxx
 Formed BMC housing, prismatic plastic lens, white inner
 reflector
 24 white LEDs

Horizontal Footcandles
 Scale: 1 Inch = 20 Ft.
 Light Loss Factor = 1.00
 Lumens Per Lamp = N.A. (absolute photometry)
 Luminaire Lumens = 5000
 Mounting Height = 24.00 Ft
 Maximum Calculated Value = 1.74 Fc
 Arrangement: Single
 Arm Length = 8 Ft





Appendix C



“Street Light Photometric”

2 Pages

Legend

-  City Boundary
-  Parcels
-  Illumination Zones

Owner (Count)

-  Surfside (83)
-  FPL (243)
-  Miami-Dade County (68)

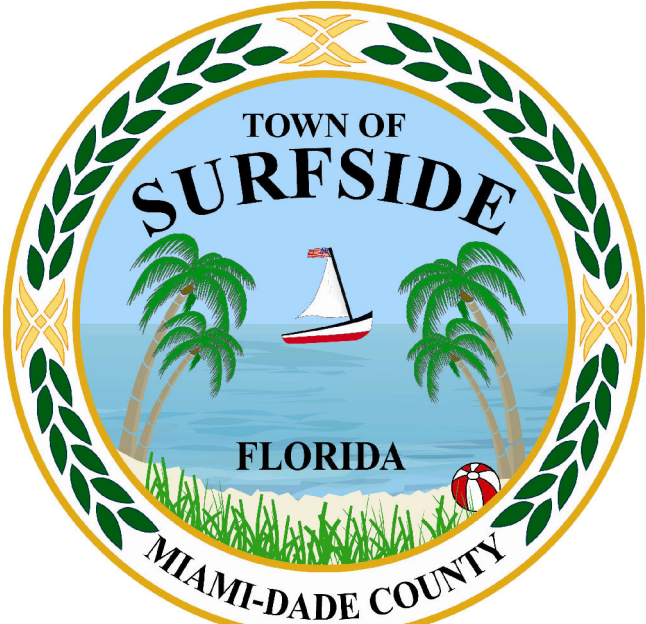

Town of Surfside Street Light Inventory

Print Date: 2/3/2020

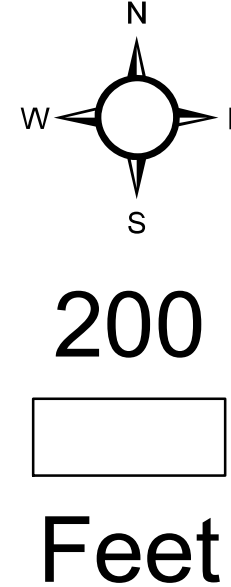

GIS Produced and maintained by the CGA
Geographic Information Systems Services

Calvin, Giordano & Associates, Inc.
EXCEPTIONAL SOLUTIONS™

Legend

-  FPL Lights
-  Parcels
-  Illumination Zones

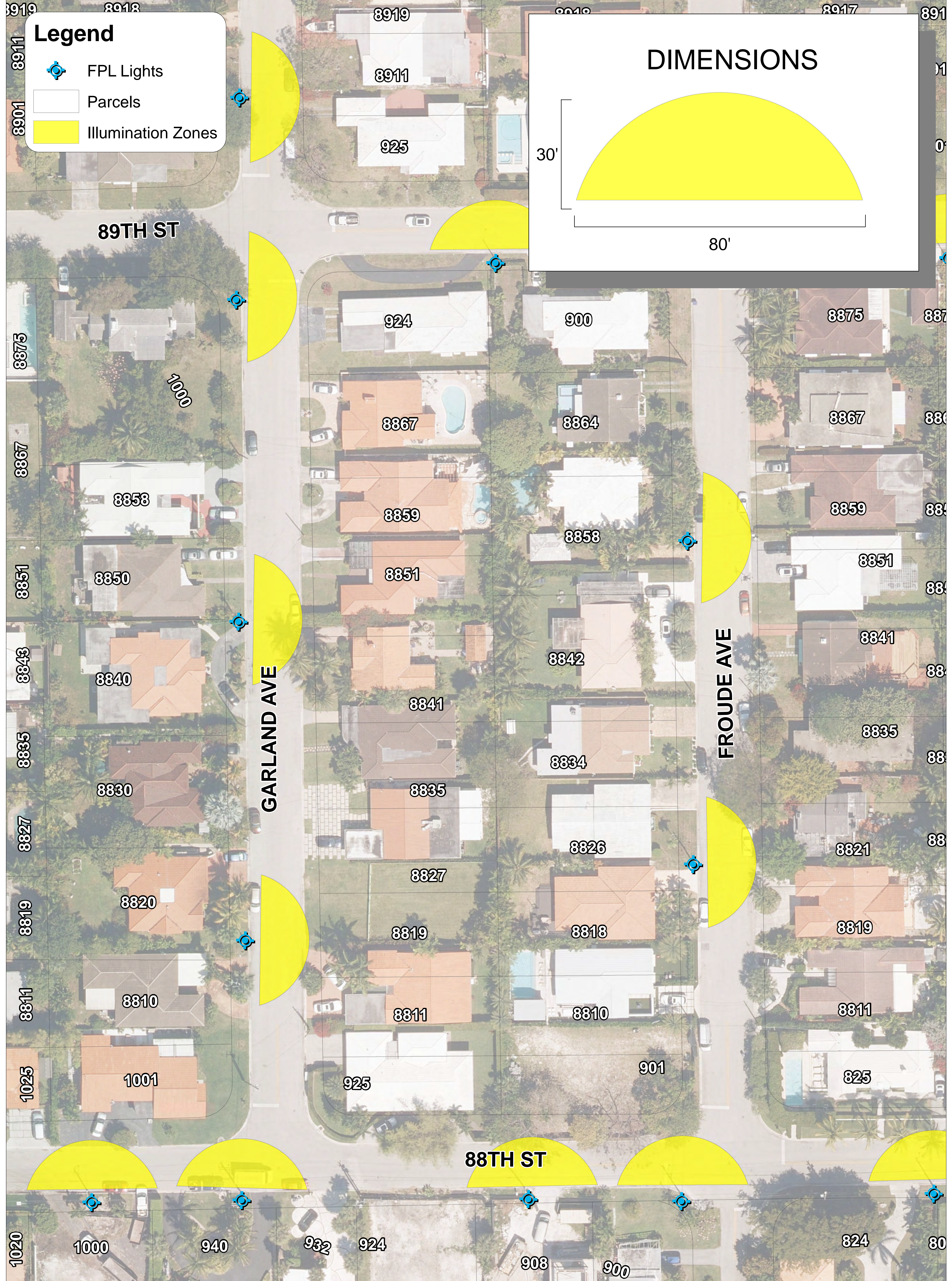
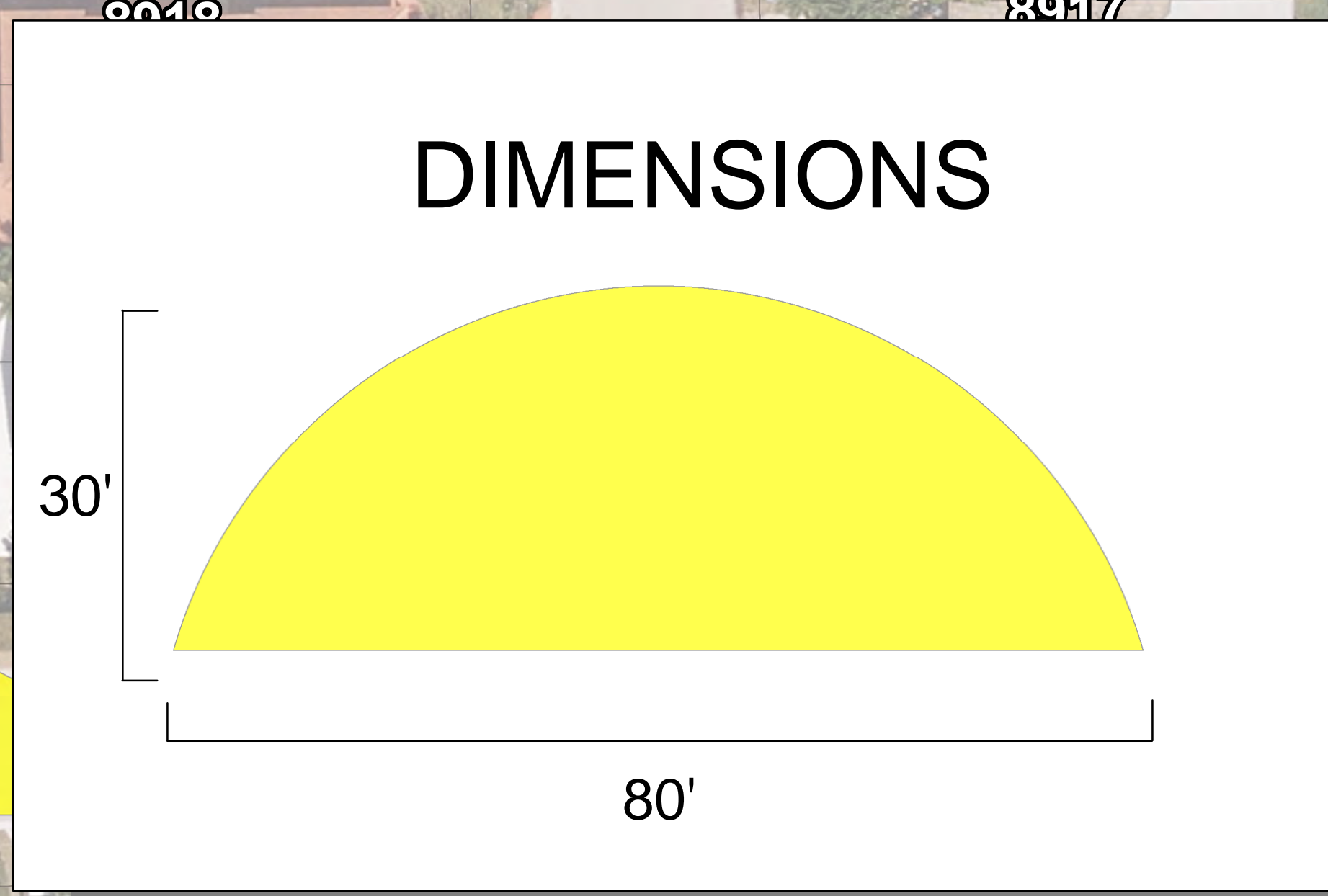

Town of Surfside Block 19 Street Light Photometrics

Print Date: 2/5/2020

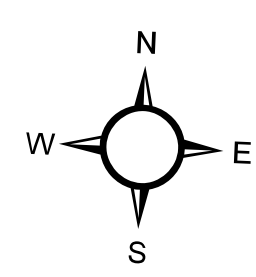

75

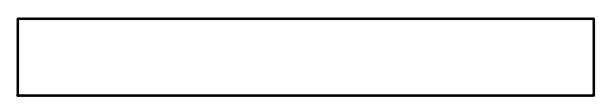

Feet









Appendix D





“Proposed Street Lights Map”

1 Page

Legend

-  City Boundary
-  Parcels
-  FPL Illumination Zones
-  Proposed Illumination Zones

Owner (Count)

-  Proposed (133)
-  Surfside (83)
-  FPL (243)
-  Miami-Dade County (68)

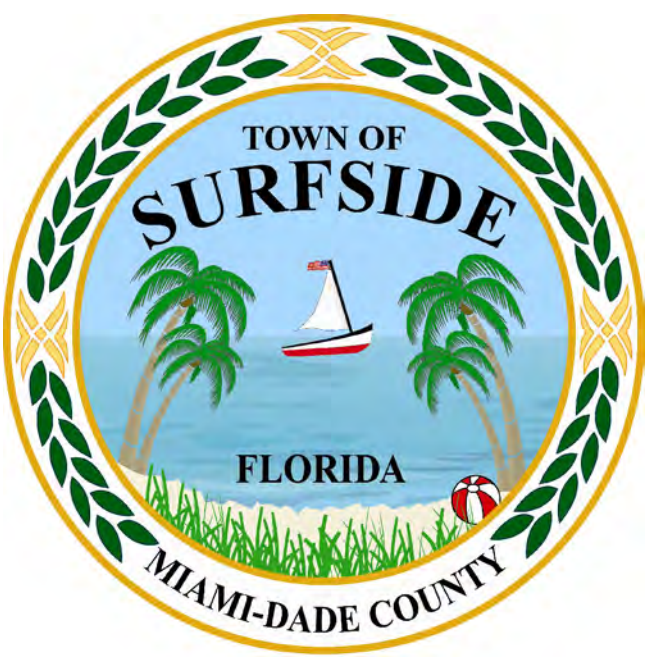

Town of Surfside Street Light Inventory

Print Date: 2/18/2020

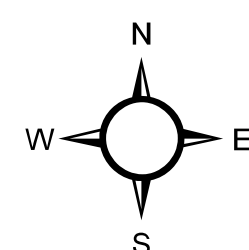

400

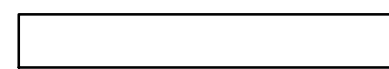

Feet

1 inch = 200 feet



Produced and maintained by the CGA
Geographic Information Systems Services



Calvin, Giordano & Associates, Inc.
EXCEPTIONAL SOLUTIONS™



MEMORANDUM

ITEM NO. 9Z

To: Honorable Mayor, Vice-Mayor and Members of the Town Commission
From: Guillermo Olmedillo, Town Manager
Date: April 21, 2020
Subject: Lowering of Property taxes and Water Bills

At the March 24, 2020 Special Commission Meeting, Town Administration was directed to provide information on lowering property taxes and water bills.

April 14 through April 21, the Town's Finance Director has meet with the Commissioners to discuss the state of the Town's finances including the financial position of the Town's General Fund and Water & Sewer Fund. With the budget season starting, the Commission will have the opportunity to provide policy direction which forms the basis of the Town's Budget. On June 1, 2020, the Town will receive the Miami-Dade Property Appraiser Assessment Roll Estimate which will help guide the Town's Administration toward the goal of lowering the financial impact to Town residents.

Attached is the Town's financial position presentation given to the Commissioners.

Reviewed by: GO

Prepared by: JDG

FINANCE ORIENTATION

April 2020

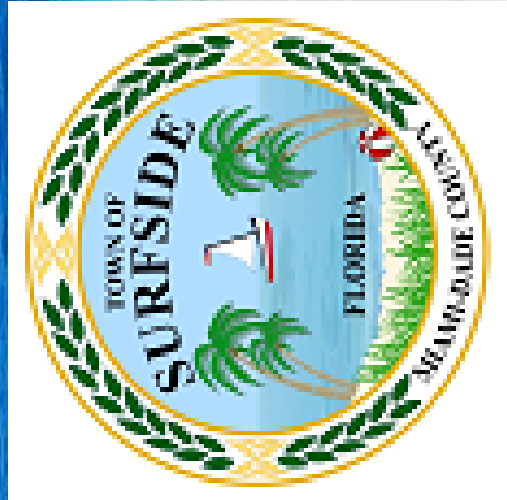

Surfside Finance Department

Financial Reporting

PAGE 536

- Fiscal Year = October 1st thru September 30th
- Comprehensive Annual Financial Report (CAFR)
- Government Finance Officers Association (GFOA)
 - Certificate of Achievement for Excellence in Financial Reporting Program
 - <https://www.gfoa.org/best-practices>



Other Reports

- **Florida Department of Finance**
 - Annual Financial Report (AFR)
- **Florida Auditor General**
 - Local Government Audit Report
- **State and/or Federal Single Audit Report**
- **Office of the Citizens' Independent Transportation Trust**
 - Audit every 5 years
 - Reporting quarterly and annually
- **Federal and State Law Enforcement**
 - Police Forfeiture funds
- **Local Highway Finance Report**
 - State revenue sharing

Fund Accounting

What is a Fund?

- A fund is like having a different checking account for different purposes



Types of Funds



Governmental



Proprietary



Fiduciary



Internal
Service

Governmental Funds



General Fund

Accounts for revenues including property taxes, sales taxes, and fines, as well as expenditures like Police and General Government

Special Revenue Funds

Used for revenue sources that can only be used for a specific purpose (ex. Building, Resort Taxes)

Capital Project Fund

Accounts for major capital construction or acquisition of major assets

Other Funds

Proprietary Funds

- Government services that are financed in whole or in part by fees paid by those who benefit from the services



Fiduciary Fund

- Used when a government unit acts as a trustee or agent



Internal Service Fund

- Accounts for cost of maintaining Town's fleet



Balance Sheet - Reserves

- The Town is in good financial position
- General Fund (2019 UNAUDITED)
 - \$2.0M assigned fund balance (Hurricane Reserve)
 - New Resiliency Reserve created in FY 2020
 - \$13.0M unrestricted fund balance
- Other governmental funds (Restricted or Assigned)
 - Building Fund \$2.6M
 - Capital Projects Fund \$3.0M
 - Tourist Resort \$1.6M
 - Other (Trans./Police) \$435k
- Enterprise funds (Restricted)
 - Water & Sewer (\$1.5M)
 - Stormwater \$3.2M
 - Parking \$1.2k
 - Solid Waste \$655k

Unassigned General Fund Reserves

Fiscal Year	Amount	Increase	Increase
2009	\$ 7,178,552		
2010	\$ 867,867	\$ (6,310,685)	-87.9%
2011	\$ 1,958,783	\$ 1,090,916	125.7%
2012	\$ 3,121,636	\$ 1,162,853	59.4%
2013	\$ 3,151,275	\$ 29,639	0.9%
2014	\$ 4,204,273	\$ 1,052,998	33.4%
2015	\$ 3,722,284	\$ (481,989)	-11.5%
2016	\$ 5,170,003	\$ 1,447,719	38.9%
2017	\$ 6,460,802	\$ 1,290,799	25.0%
2018	\$ 8,902,050	\$ 2,441,248	37.8%
2019	\$ 12,983,069	\$ 4,081,019	45.8%

General Fund Reserves compared to Property Tax Revenues

Fiscal Year	Reserves	Revenues	% Ratio
2009	\$ 7,178,552	\$ 6,325,721	113.5%
2010	\$ 867,867	\$ 5,323,728	16.3%
2011	\$ 1,958,783	\$ 5,619,494	34.9%
2012	\$ 3,121,636	\$ 5,264,387	59.3%
2013	\$ 3,151,275	\$ 5,257,726	59.9%
2014	\$ 4,204,273	\$ 5,660,551	74.3%
2015	\$ 3,722,284	\$ 6,526,267	57.0%
2016	\$ 5,170,003	\$ 7,276,466	71.1%
2017	\$ 6,460,802	\$ 8,167,329	79.1%
2018	\$ 8,902,050	\$ 9,626,611	92.5%
2019	\$ 12,983,069	\$ 12,835,787	101.1%

Enterprise Funds Unrestricted Reserves

PAGE 544

Fiscal Year	Water & Sewer	Stormwater	Solid Waste	Parking
2009	\$ 448,793	\$ (77,137)	\$ (128,427)	\$ 2,526,724
2010	\$ 440,000	\$ 40,626	\$ 82,210	\$ 2,043,034
2011	\$ 1,674,603	\$ 188,302	\$ 207,462	\$ 1,385,581
2012	\$ (2,949,483)	\$ (161,489)	\$ 228,437	\$ 1,258,325
2013	\$ (5,261,333)	\$ 2,520,512	\$ 227,274	\$ 1,066,574
2014	\$ (3,501,884)	\$ 3,838,412	\$ 116,662	\$ 1,000,355
2015	\$ (2,705,871)	\$ 4,051,768	\$ 340,391	\$ 1,089,165
2016	\$ (1,489,769)	\$ 3,626,325	\$ 245,941	\$ 1,111,941
2017	\$ (3,048,579)	\$ 1,456,556	\$ 429,743	\$ 811,013
2018	\$ (2,546,398)	\$ 3,203,878	\$ 601,201	\$ 943,315
2019	\$ (1,477,313)	\$ 3,200,646	\$ 655,448	\$ 1,185,311
2020	\$ (1,136,724)	\$ 3,034,923	\$ 432,957	\$ 1,108,943

Debt

- **No General Obligation, Capital Leases, or Pension Obligation debt**
 - **Utility System Revenue Bond Series 2011**
 - Improvements to facilities for the water, sewer, and stormwater systems
 - \$16M issued
 - \$7.3M outstanding as of September 30, 2019
 - Final payment – 2026
 - **Clean Water State Revolving Loan**
 - Improvements to facilities for the sewer and stormwater systems
 - \$9.31M issued
 - \$6.86M outstanding as of September 30, 2019
 - Final payment – 2033
- *all debt serviced with water, sewer, & stormwater funds**

Budgeting

FISCAL YEAR 2020



Budget Glossary

- Budget:** A plan of financial activity for a specified period of time (fiscal year) indicating all planned revenues and expenses for the budget period.
- **Millage:** Derived from a Latin word "millesimum" meaning "thousandth," with 1 mill being equal to 1/1,000th of a currency unit. As used in relation to property tax, 1 mill is equal to \$1 in property tax, which is levied per every \$1,000 of a property's determined taxable value.
 - **Taxable Valuation:** This is the amount determined by the Property Appraiser after any discounts and/or exemptions have been applied to the assessed valuation. This reduced figure is the one against which governments may levy a tax.

Budget Process

- Budget development and management is a year-round process.
- Budget preparation begins in February-March and is designed to assist the Town's management in the development of short-term and long-term strategies to meet legal and policy directives as well as perceived wishes of the community including the various advisory boards and committees.
- The policy directives of the Town of Surfside's Town Commission are the principal focus of each budget process.
- Government Finance Officers Association (GFOA) Distinguished Budget Presentation Award



Budget Timeline

- **March** Initiate Budget Development Process
- **April** Distribute budget package to Department Directors
- **April** Budget Goals and Objectives Workshop with Town Commission to set budget priorities
- **April-May** Budget Retreat – Town Manager and Department Directors
- **May** Departments submit budget requests. Meetings with Town Manager to review all requests
- **June 1st** Miami-Dade Property Appraiser Assessment Roll Estimate
- **June** Town Commission Budget Workshop

Budget Timeline

● PAGE 550

- **July 1st** “Certification of Taxable Value” received from the Property Appraiser
- **Early July** Proposed Budget submitted to Town Commission
- **Mid-July** Town Commission meets to set tentative property millage rates
- **Early Aug** Notify Property Appraiser - proposed millage rate, etc.
- **July-Aug** Proposed Budget finalized based on Town Commission budget discussion and final taxable value
- **Sept** First and second public hearings
 - Adopt millage rates
 - Adopt operating and capital budgets

*Florida Statute precludes local governments from conducting its budget hearings on the same date as Miami-Dade County and the Miami-Dade County School Board

Budget Components

General Fund

- General Government
- Public Safety
- Physical Environment
- Streets
- Non-Community Center Parks & Recreation

Special Revenue Funds

- Building Services
- Tourist
- Transportation
- Police Forfeiture

Capital Projects Fund

- Physical Environment

Enterprise Funds

- Water & Sewer
- Stormwater
- Solid Waste
- Parking

Internal Service Fund

- Fleet Management

Special Revenue Funds – What do you get?

• **PAGE 552**

• **Transportation Fund**

- Generated through the Miami-Dade County half-penny sales surtax
- Use of the funds include a Community Bus Service as well as sidewalk replacements, bus stop maintenance, etc.
- **Police Forfeiture**
- Funded through forfeitures, seizures, and confiscations related to criminal activity
- Use of the funds is restricted to crime prevention initiatives

• **Building Fund**

- Account for the building department activities
- Revenues are collected from development activity to fund building department operations

Special Revenue Funds – What do you get?

- **Tourist Resort Fund**

PAGE 553

- Generated from taxes placed on certain types of private enterprise – food and beverage sales and accommodations
- Sixty-six percent (66%) of total revenues allocated for the cost of operating the Community Center and collection of resort tax
- Pursuant to Chapter 67-930 of State of Florida law, and further defined in the Town’s Ordinance No. 11-1574, a minimum of 34% of the resort tax revenue must be used to promote the Town as a tourist destination
- The expenditure of these funds is governed by the Tourist Bureau Board
- Used to fund the other initiatives, also enjoyed by residents:
 - Annual holidays lights on Harding Avenue
 - Popular events, including Third Thursdays, First Fridays, Paddletopia, Bootcamp & Brews, History Tours, and more

Community Center Budget is ~\$2.2M in Fiscal Year 2020

This funding provides property tax relief as these operations are no longer supported by the General Fund

Property Values

Taxable Property

Fiscal Year	Millage Rate	Value	Value Increase	% Increase
2009	4.7332	\$ 1,531,669,419		
2010	4.7332	\$ 1,283,401,231	\$ (248,268,188)	-16.2%
2011	5.6030	\$ 1,062,959,623	\$ (220,441,608)	-17.2%
2012	5.5000	\$ 1,017,658,274	\$ (45,301,349)	-4.3%
2013	5.3000	\$ 1,062,214,226	\$ 44,555,952	4.4%
2014	5.2000	\$ 1,144,071,250	\$ 81,857,024	7.7%
2015	5.0293	\$ 1,336,876,007	\$ 192,804,757	16.9%
2016	5.0293	\$ 1,502,755,220	\$ 165,879,213	12.4%
2017	5.0144	\$ 1,689,439,338	\$ 186,684,118	12.4%
2018	4.8000	\$ 2,150,458,492	\$ 461,019,154	27.3%
2019	4.5000	\$ 3,086,020,534	\$ 935,562,042	43.5%
2020	4.4000	\$ 3,116,633,395	\$ 30,612,861	1.0%

Property Taxes

Fiscal Year	Millage Rate	Taxable Property Value	Property Taxes Collected	% Increase
2009	4.7332	\$ 1,531,669,419	\$ 6,325,721	
2010	4.7332	\$ 1,283,401,231	\$ 5,323,728	-15.8%
2011	5.6030	\$ 1,062,959,623	\$ 5,619,494	5.6%
2012	5.5000	\$ 1,017,658,274	\$ 5,264,387	-6.3%
2013	5.3000	\$ 1,062,214,226	\$ 5,257,726	-0.1%
2014	5.2000	\$ 1,144,071,250	\$ 5,660,551	7.7%
2015	5.0293	\$ 1,336,876,007	\$ 6,526,267	15.3%
2016	5.0293	\$ 1,502,755,220	\$ 7,276,466	11.5%
2017	5.0144	\$ 1,689,439,338	\$ 8,167,329	12.2%
2018	4.8000	\$ 2,150,458,492	\$ 9,626,611	17.9%
2019	4.5000	\$ 3,086,020,534	\$ 12,835,787	33.3%
2020	4.4000	\$ 3,116,633,395	\$ 13,027,528	1.5%

TAXABLE VALUES & MILLAGE RATES

10 YEARS

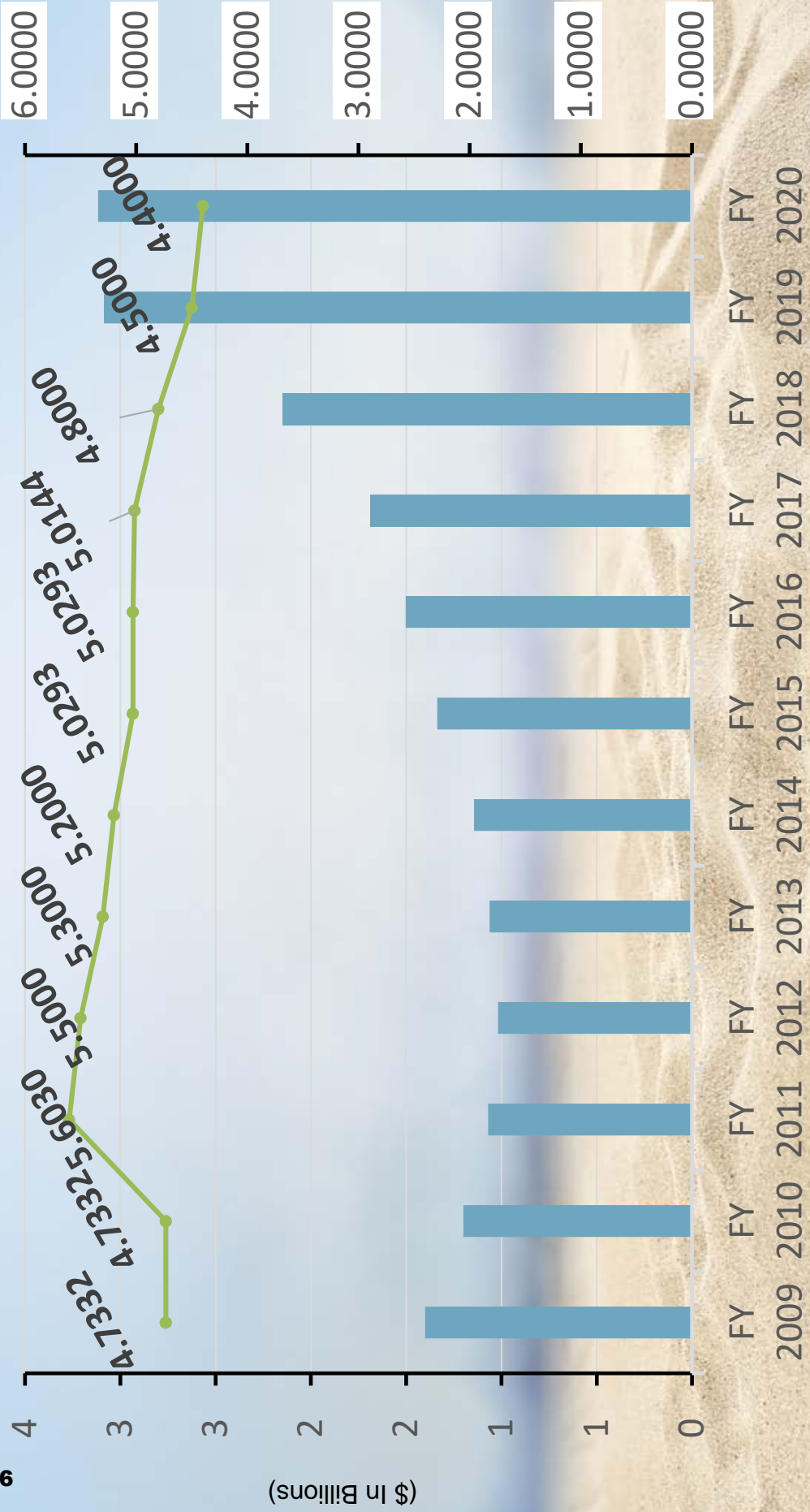

HOW MUCH OF YOUR TAX BILL GOES TO THE TOWN?

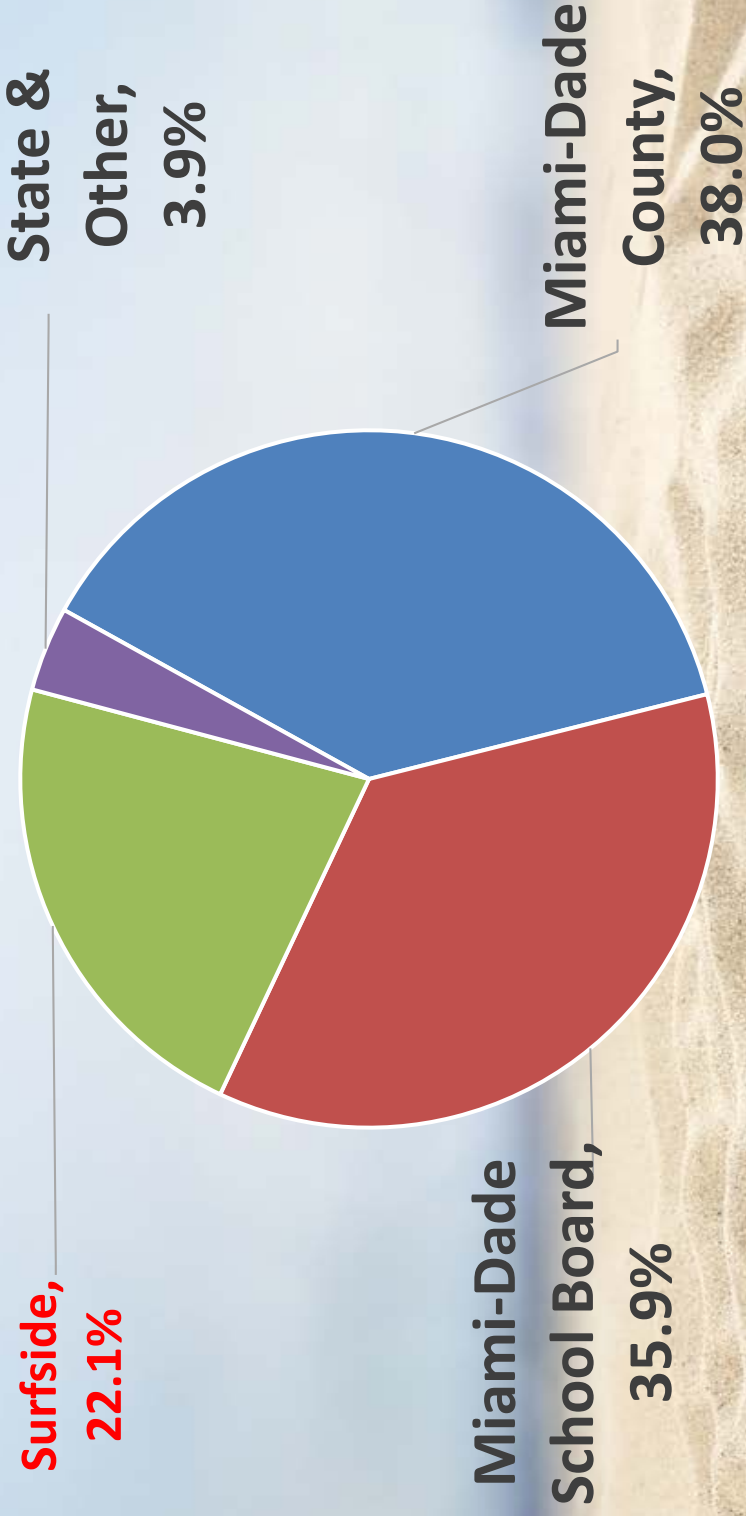

77.9% of Surfside property taxes go to other entities

Property Tax Distribution 2019 Millage Rates

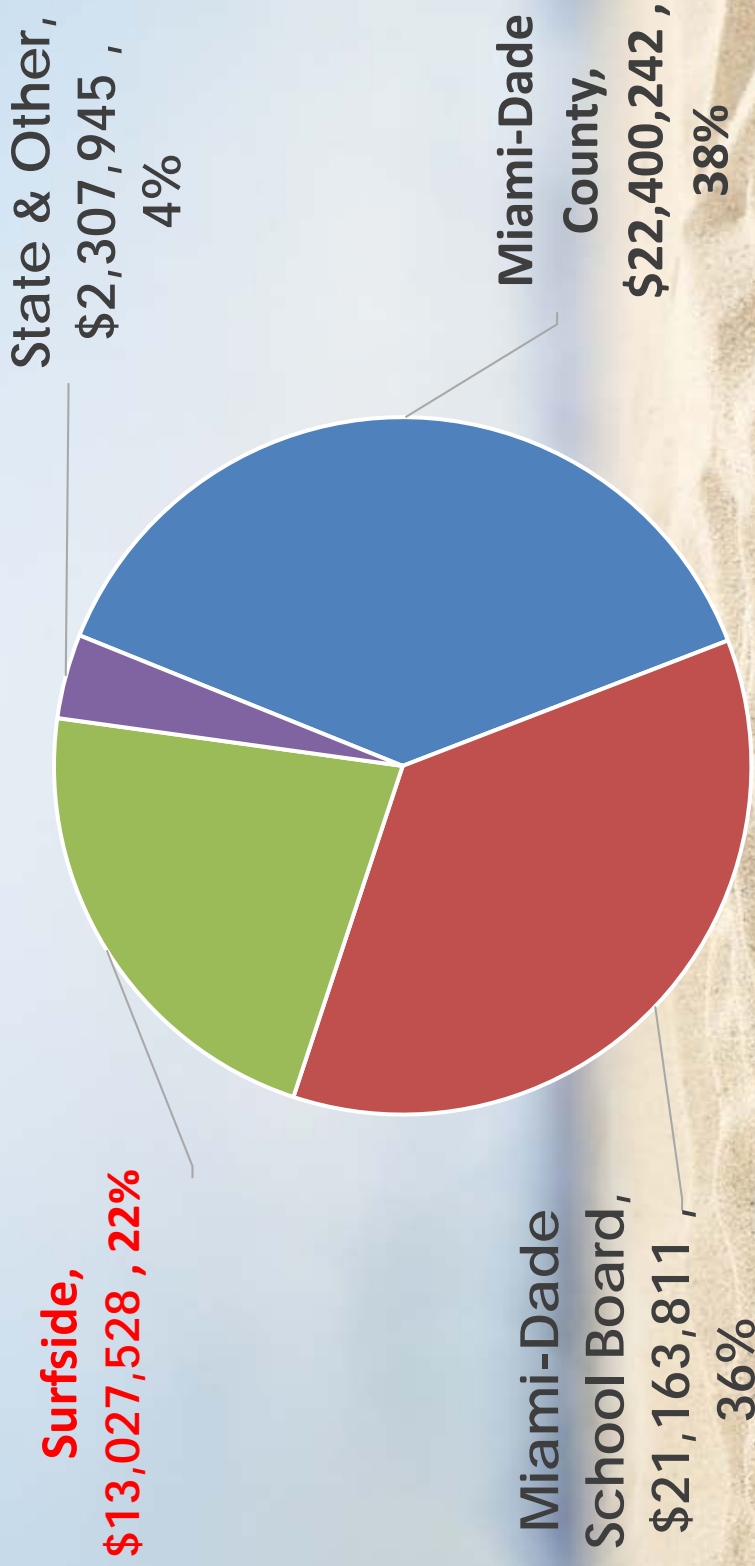

\$45.9M of the \$58.9M in Surfside property taxes go to other entities

Property Taxes Millage Rates

Fiscal Year Surfside County Miami-Dade School Board

2009 4.7332 5.1229 7.7970

2010 4.7332 5.1229 7.9950

2011 5.6030 5.8725 8.2490

2012 5.5000 5.0900 8.0050

2013 5.3000 4.9885 7.9980

2014 5.2000 5.1255 7.9770

2015 5.0293 5.1169 7.9740

2016 5.0293 5.1169 7.6120

2017 5.0144 5.0669 7.3220

2018 4.8000 5.0669 6.9940

2019 4.5000 5.1313 6.7330

2020 4.4000 5.1449 7.1480

Fiscal Year 2020 General Fund Revenues & Expenditures

\$16.5M Projected Revenues

78.7% Ad Valorem

9.0% Franchise / Utility
 6.7% Intergov/ Charges for Services
 5.6% Other



44.2% Public Safety

36.9% General Government

10.4% Physical Environment
 8.5% Other

\$14.4M Projected Expenditures

\$2.1M added to General Fund Reserves

Revenues Forecast General Fund

\$16.5 Million

- Ad Valorem \$13.0 Million
- Franchise/Utility \$1.5 Million
- Intergovernmental \$637,500
- Interfund \$539,000
- Charges for Services \$478,700
- Other \$376,500

FY 2020 General Fund Revenues

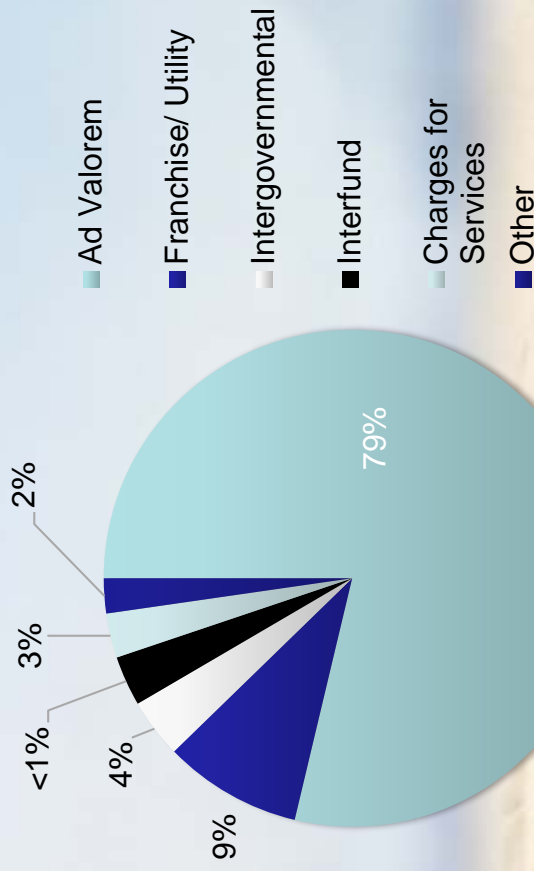

General Fund Expenditures

\$14.4 Million

- Public Safety \$6.4 Million
- General Government \$5.3 Million
- Physical Environment \$1.5 Million
- Recreation/Community \$819,932
- Interfund (Capital) \$225,000
- Streets \$190,331

FY 2020 General Fund Expenditures

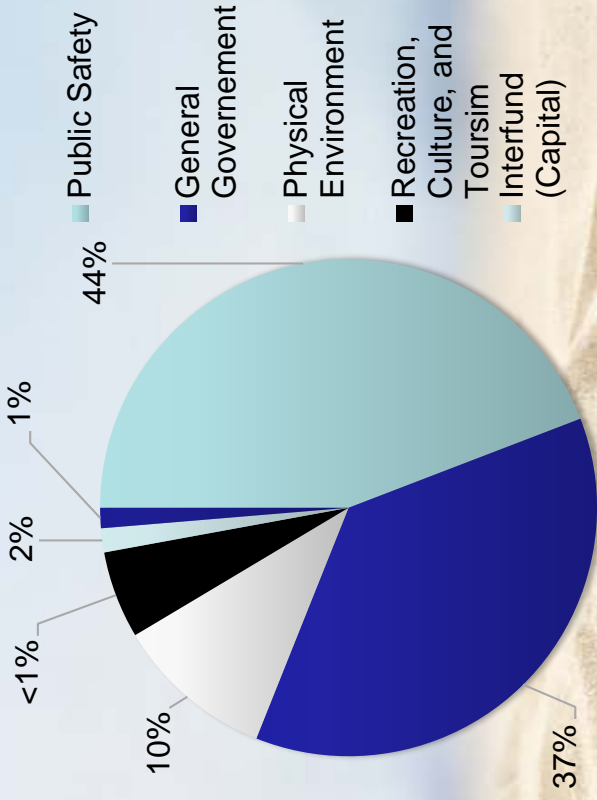

Enterprise Funds – Water & Sewer

- The Town operates its Water and Sewer System and funds the operations, maintenance, administration, debt service, and infrastructure renewal and replacement needs through user fees and available reserves.
- The Town has issued bonds to pay for a portion of its water and sewer capital project and the debt service is repaid through the system's net revenues.
- Town water is purchased from Miami-Dade County at wholesale rates and transmitted through Town owned water lines.
- Wastewater (sewer) runs through the Town's collection system and is discharged under an agreement with the City of Miami Beach.
- The Water and Sewer division also performs functions related to billing and collection for the services provided.
- General Town administrative support provides services for Water and Sewer operations such as: oversight, finance, payroll, human resources, benefits and pension management, and the provision of office space.

Fiscal Year 2020 Water & Sewer Fund Revenues & Expenditures



*81% of the Operating Costs are direct past throughs
 *75% of the all expenses are debt service and pass throughs

\$340,000 added to Reserves – FY 19 FY end balance = (\$1.4M)

Enterprise Funds – Parking

● PAGE 565

- The Town operates its own municipal parking enterprise fund. The Town currently operates several parking lots and on-street parking spaces to provide parking throughout Town and convenient access to the Harding Avenue business district.
- Municipal Parking operations are under the supervision of the Public Safety Department.
- The Town provides these services with Parking Division in-house staff and contracts with a private company for collection from parking meters.
- Parking citation revenue is allocated to the General Fund.
- General Town administrative support provides services for Municipal Parking operations such as: oversight, finance, payroll, human resources, benefits and pension management, and the provision of office space.

Fiscal Year 2020 Parking Fund Revenues & Expenditures

\$1.3M Projected Revenues

82% Metered Fees
12% Permit Fees and Other
6% Fund Balance



45% Operating Costs

44% Personnel Costs

11% Other Costs

\$1.3M Projected Expenditures

\$76,000 reduction in Reserves – FY 19 FY end balance = \$1.2M

Enterprise Funds – Solid Waste

● PAGE 567

- The Solid Waste Fund accounts for the cost of operating and maintaining collection and disposal services for Town residents and commercial businesses/properties.
- Solid waste collection and disposal services are provided by the Town for garbage, bulk trash, and vegetation.
- The Town provides in-house collection and disposal of recyclable materials for residential properties.
- Solid waste collection charges for residential property are billed by Miami- Dade County on the real property tax notice as a non-ad valorem assessment. The residential property assessment of \$318.67 for garbage/recycle is assessed for FY 2020. Variable rates are charged for multi-family units and commercial properties. The Town is in the process of evaluating commercial rates.
- General Town administrative support provides services for Solid Waste operations such as: oversight, finance, payroll, human resources, benefits and pension management, and the provision of office space.

Fiscal Year 2020 Solid Waste Fund Revenues & Expenditures



\$222,000 reduction in Reserves – FY 19 FY end balance = \$655,000

Enterprise Funds – Stormwater

- The Stormwater Utility Fund accounts for the cost of operating and maintaining the Town's stormwater drainage system in accordance with the Environmental Protection Agency National Pollutant Discharge Elimination System (NPDES) permit.
- The Town is in the process of developing a Stormwater Master Plan which should be updated at 5 year to properly document new projects and to adapt with future conditions. (On Hold)
- The Town contracts out many of the stormwater related functions.
 - Include planning, developing, testing, maintaining, and improving the management of waters resulting from storm events.
 - Vacuum truck services as well as a street sweeping program to maintain the stormwater infrastructure are funded.
- General Town administrative support provides services for stormwater operations such as: oversight, finance, payroll, human resources, benefits and pension management, and the provision of office space.

Fiscal Year 2020 Stormwater Fund Revenues & Expenditures

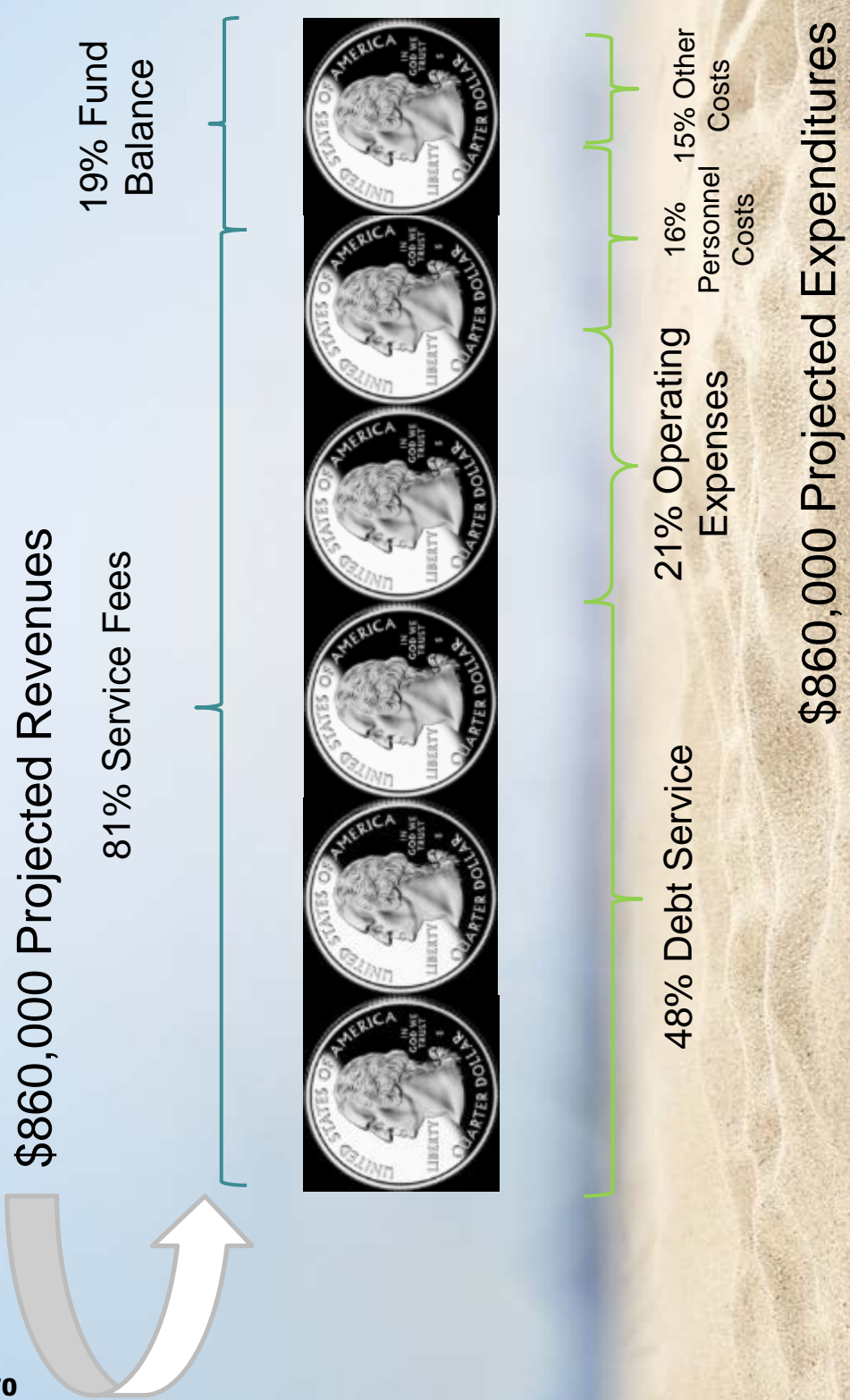

Contact Info

PAGE 571

- Website: <https://townofsursidefl.gov/departments-services/finance>
- Jason D. Greene, CGFO, CFE, CPFIM, CICA
jgreene@townofsursidefl.gov





MEMORANDUM

ITEM NO. 9AA

To: Honorable Mayor, Vice-Mayor and Members of the Town Commission
From: Guillermo Olmedillo, Town Manager
Date: May 26, 2020
Subject: Calvin Giordano Contracts

At the May 12, 2020 Commission Meeting, the Commission has requested a report on the Calvin Giordano contracts laying out the options and a recommendation for each service area. At the May 14, 2020 Special Commission meeting on Planning & Zoning, the Commission provided direction to both prepare RFQ for Planning department services as soon as possible and advertise a new in-house planner.

General Engineering Consultant (GEC) Services

- Option #1 – Re-procure services now
 - Prepare RFQ as soon as possible for Architecture, Engineering and Surveying Services per Consultants' Competitive Negotiation Act (CCNA), section 287.055, Florida Statutes
 - Select a pool of engineering firms that will be pre-qualified
 - CGA to remain until such time as a vendor(s) are under contract and transition complete
- Option #2 - Complete CGA contract term ending September 30, 2021
 - Begin re-procurement later in year so as to be ready for possible transition to a new vendor(s)
- Option #3 – Build new In-house Engineering Department
 - Develop cost for an inhouse Engineering Department
 - CGA to remain until such time as new staff are hired and transition complete

Information Technology

- Option #1 – No change
 - Continue with services as provided
- Option #2 – Bring Multi-media Specialist in-house
 - Develop cost for an in-house Multi-media specialist
 - CGA services to remain until such time as new staff are hired and transition complete
- Option #3 – Build new In-house Information Technology Department (all staff)
 - Develop cost for an in-house Information Technology Department
 - CGA to remain until such time as new staff are hired and transition complete
- Option #4 – Re-procure services now
 - Prepare RFQ as soon as possible for Information Technology consultants
 - CGA to remain until such time as a vendor is under contract and transition complete

The Administration recommends option #1 for GEC services and Information Technology.

Reviewed by: GO/LA

Prepared by: JDG

IT Services Contract – CGA number 17-9175

Monthly Fee: \$11,031.31

Potential Additional Fees: \$238.29 per broadcasting event – including setup, AV during meeting, posting after the meeting is over. Average Commission Meetings are 4 hours (30 min setup, 3-hour meeting, 30 min broadcasting of video)

After hours or weekend services (Police Department Emergencies/ Downtime to background check servers) \$101.34/hour only at Town request.

Staff assigned to contract: Jose Feliz, Support Specialist Full Time dedicated to the Town of Surfside
Eric Wells, Network Administrator Part Time dedicated to the Town of Surfside- as needed oversight, assistance and PTO coverage.

Adrian Santaella, Media Specialist Part Time (contract states 15.5 hours per month) dedicated to the Town of Surfside as needed for website updates.

Monthly Fee hours dedicated per month:

170 hours

Monthly Fee Brief scope of work:

Desktop support for all Town Staff including the Police Department, including:

- Maintain and trouble shoot all servers, computers, software, printers, scanners, phone systems at all locations
- Specifying, purchasing and setup of all new IT equipment for staff and PD
- Maintaining uptime on servers, Police Department USA Software and FDLE
- Troubleshooting Tyler ERP Software
- Upgrading Town equipment as needed, including Data Center, Data Domain, Backup Systems and Servers
- Specifying, procuring and managing installation of security systems including door strikers, locks and cameras
- Recording and Broadcasting all Public Meetings
- Closed Caption for Channel 663 and Video Streaming
- Hosting the Town Website, ensuring Website ADA Compliance and up to 20 hours of Website posts and updates
- Parks & Recreation RecTrac software upgrade implementation
- Managing NetMotion and AT&T to integrate GPS on all Town equipment such as Laptops as a theft deterrent/tracking system.
- Managing Surveillance Cameras for PD, Town Hall, Abbott Lot, 96th Park and Community Center.
- Keeping SCALA up to date (Town Broadcasting)

Calendar year 2019 costs: \$272,688

Planning & Zoning Contract – CGA number 07-1539 Surfside Planning & Zoning & 07-1536 Community Development Director

Monthly Fee: \$6,695.34 (P&Z) & \$8,990.87 (Community Development) - Total \$15,686.21

Potential Additional Fees: Cost Recovery:

Large development projects may result in additional fees which are paid as a cost recovery fee, which is paid by the developer and not from the Town's funds.

Other additional Planning & Services not contained in Monthly Fee:

Planning & Zoning Extra - Billed per hour on as needed basis and authorized at up to \$15,500 for FY 2020:

Renderings requested by Town Administration or the Planning and Zoning Board performed by Urban Designers.

Resiliency Planning & Meeting attendance - Billed per hour on as needed basis and authorized at up to \$6,818.62 for FY 2020:

As requested, attendance at Resiliency-type meetings

Staff assigned to contract:

Sarah Sinatra Gould, AICP, Director of Planning Services, largely working for the Town of Surfside. Coordinates studies and graphics relating to requests by the Planning and Zoning Board. Answers calls and emails from the public. Performs cursory reviews of applications for the public prior to submittal for Planning and Zoning. Performs code updates as requested by the Planning and Zoning Board and/or Town Commission.

James Hickey, AICP, Planning Administrator, Part time dedicated to the Town- provides assistance and coverage for Sarah Sinatra Gould to ensure complete continuity through PTO or other absences. Reviews applications and provides feedback to the public.

Daniel Mantell, Planner, Part time dedicated to the Town - reviews residential and sign applications, responds to emails from residents, staff and developers.

Joanne Maglietta, Zoning Tech, part time dedicated to the Town- responds to phone calls and emails. Answers general zoning questions. Provides responses to zoning confirmation letters.

Casey Ogden, GIS Specialist, Part time dedicated to the Town – provides GIS graphics and produces maps relating to distance separation of uses as requested by the Planning and Zoning Board.

Monthly Fee hours dedicated per month:

150 hours

Monthly Fee Brief scope of work:

Complete management of the Planning & Zoning Department:

- Prepare reports, data, analysis, graphics and other assignments requested by the Planning and Zoning Board
- Prepare presentations and present staff reports for public hearings, including Commission Meetings
- Attend Staff meetings, Town Commission meetings, Development Review meetings and Planning and Zoning Board meetings
- Act as liaison between Town, South Florida Regional Planning Council and State Department of Economic Opportunity and such other local, state and federal agencies as may interact with Surfside for the various programs within the Planning Department
- Attend County and State agency meetings and forums as required
- Answer calls and emails from the public relating to zoning questions
- Answer calls and emails from Mayor, Vice Mayor, Commissioners and Town Staff
- Provide cursory reviews of plans to residents prior to submitting for planning and zoning or permits
- Review and administer zoning permits
- Review development applications through cost recovery
- Interact as needed with Town Staff including permit review with the Town Building Department

Calendar year 2019 costs: \$248,416

Engineering Services Contract – CGA number 07-1541

Monthly Fee: \$7,669.40

Potential Additional Fees: Special projects/tasks such as 10-year water supply, Stormwater Master Plan, etc. with costs based on hourly rates. Proposals are submitted to Town Staff for review then presentation to Commission, as required, for discussion and approval or rejection.

Other additional Engineering Services not contained in Monthly Fee:

Water & Sewer Support - Billed per hour on as needed basis and authorized at up to \$24,900 for FY 2020:

Hourly Town Staff supplemental support including, but not limited to Engineering assistance for atlas upgrades, printing, electronic updates, etc., leaks, breaks, pump station trouble shooting, repairs, and operational assistance, calls and email responses in the event of a loss of service to either water or sewer system, initial project review and discussion. Constructability questions and reviews for any Town Staff inquiries/in-house projects. Any portion of the PO that is not utilized is not billed to the Town.

Stormwater/NPDES Support - Billed per hour on as needed basis and authorized at up to \$6,000 for FY 2020:

Hourly Town Staff supplemental support to include Engineering assistance for as-builts/atlas updates, NPDES monitoring and reporting, drainage pump station troubleshooting, repairs and maintenance and operational assistance. Constructability questions and reviews for any Town Staff inquiries/in-house projects. Any portion of the PO that is not utilized is not billed to the Town.

Staff assigned to contract: Nicholas Kanelidis, PE Project Manager - a portion of everyday dedicated to the Town of Surfside

James Hart, PE, Project Manager – Part time dedicated to the Town – review of pump station controls and data for Sewage and Drainage Stations

Jenna Martinetti, PE Director of Engineering – Part Time dedicated to the Town- oversight of staff and assistance as needed

Bob McSweeney, PE, Director of Construction – Part time dedicated to the Town – construction related questions, constructability reviews and review comments for any outside or in-house projects.

Chris Giordano, MSC, CCM, Vice President – Part Time dedicated to the Town- client contact, oversight and assistance as needed

Monthly Fee hours dedicated per month:

60 hours

Monthly Fee Brief scope of work:

Staff and manage the Town's Engineering Department as required to complete the following tasks:

- Phone calls, emails, presentation preparation and meetings as needed with Staff, Boards and Commission regarding engineering or Public Works related items, questions and concerns
- Daily monitoring of the Town's five (5) pump stations: alarm review, run time review, number of starts, instrumentation functioning check
- Monthly and quarterly meetings (Utility Round Table) with the County to ensure compliance of all required regulations and reporting – complete County required reporting
- Annual GIS reporting to the County for water, sewer, and drainage infrastructure
- Sewage Transmission and Disposal Duties
 - Documentation/Reporting required by Consent Decree
 - Documentation/Reporting required by Consent Agreement
 - NAPOT Report Review
 - Analysis and Graphing of Sewage Flow vs Rainfall
 - Inflow Infiltration Analysis
 - Billing Review from County
 - Annual CMOM reporting to the County
 - Annual SSES reporting to the County
- Water Distribution and Consumption Duties
 - Billing Review from the City
 - Lead and Copper Reporting and Compliance
 - Monthly water accounting to determine water sold versus water loss
 - Monthly bacteriological test reporting for the County
- Project Feasibility/Analysis
 - Participate in discussions with Staff, Residents and Commission regarding any potential projects
 - Provide input/cost analysis for potential projects
 - Present to Commission on potential projects and estimated costs/benefits
- Minor grant writing assistance
 - Technical write-up
 - Exhibits
 - Potential Project Cost Estimates

Calendar year 2019 costs: \$273,127

**For additional information on calendar year 2019 tasks including projects see attached supplemental*

CGA Payments by contract/tasks for Calendar Year 2019

	<u>CY 2019</u>		
	Paid		
Information Technology			
General Services			
Monthly IT retainer	130,290	48%	
Extra Services			
After hours extra time	16,646	6%	
Broadcasting support	10,553	4%	
Projects			
ERP Implementation Support	115,200	42%	
	<u>272,688</u>	<u>100%</u>	34%
Planning & Zoning/Community Development			
General Services			
Community Development Director Services - Monthly retainer	106,135	43%	
Planning and Zoning – Monthly retainer	78,589	32%	
Extra Services			
Planning & Zoning extra hrs. outside of monthly retainer	11,539	5%	
Cost Recovery (part of Planning Contract)	22,032	9%	
Projects			
Resiliency Planning (Climate Change Action Report)	30,122	12%	
	<u>248,416</u>	<u>100%</u>	31%
Engineering/PW			
General Services			
General Engineering Services – Monthly Retainer	90,547	33%	
Extra Services			
General Public Works extra hours outside of monthly retainer	87,153	32%	
Water & Sewer Support Services	36,782	13%	
GIS Water/Sewer	160	0%	
Projects			
Downtown Street Lighting Support	412	0%	
Stormwater Master Plan	4,731	2%	
Solar Panel Engineering Support	14,596	5%	
96th Street Park RFP Support	6,014	2%	
96th Street Park Survey	3,735	1%	
Traffic signal mods at 88, 93, and 94 St - bidding assist., CEI, closeout	8,687	3%	
Town of Surfside Street Light Inventory	2,263	1%	
Surfside Community Center Indoor Air Quality testing	1,170	0%	
Town of Surfside Dune Survey & Beach Management Plan	8,478	3%	
Surfside Parking Utilization Study - Data Collection	8,400	3%	
	<u>273,127</u>	<u>100%</u>	34%
	<u>Totals:</u>	<u>794,232</u>	

Sandra Novoa

From: Mayor
Sent: Wednesday, April 22, 2020 6:17 PM
To: Fernanda Siqueira
Subject: RE: Construction in Condos

Hi Fernanda,

Thank you for the nice note!

I think the dog park is the easier of the two requests. It seems to me with the proper safety precautions, it shouldn't be an issue. I've copied our clerk and asked that the dog park be added to the agenda for action.

On the balcony issue, I totally get your point. I can't imagine having to work, while that type of construction is going on around me. Having said that, I think the decision to work, or not work, at this time at any particular location (assuming it's done per the safety requirements) would be a decision to be made by you and your condo board. I'm not sure that we could step in and manage issues like that from the Commission. Have you tried reaching out to your condo board?

As you know, if I can be of any help with anything, I'm available.

Thanks,

Charles

Charles W. Burkett
Mayor



Town of Surfside
9293 Harding Avenue
Surfside, Florida 33154
Phone (305) 861-4863
Mobile phone: (305) 992-7965

"If you think you are too small to make an impact, try spending the night in a room with a mosquito." African proverb

-----Original Message-----

From: Fernanda Siqueira <fernandaj1@yahoo.com>
Sent: Wednesday, April 22, 2020 3:26 PM
To: Charles Burkett <charles@burkettcompanies.com>
Cc: Eliana For Commissioner Salzhauer <esalzhauer@gmail.com>; Nelly <nellyforcommissioner2020@gmail.com>; Charles Kesl <cekesl@gmail.com>
Subject: Construction in Condos

Hello Mr. Mayor and commissioners,

First of all, congratulations on “our” win! I am ver happy to have you all representing our Town now.

I’d like to voice my opinion regarding bringing construction back to the condos.

I live at the Waverly and both our buildings have been under concrete restoration, balcony repair and pool renovation for one and half year. We are next door to the Carlyle that is also working on their balconies and concrete restoration for over 2 years now. You can imagine that life here on 92nd has not been easy. The noise from the work is extremely loud, the workers park in our garages, they use our elevators and also our building bathrooms.

When they drill the balconies or outside walls, the building trembles.

I work from home, so usually just go to the library and work from there when the noise is unbearable here.

At this pandemic time, I also have my 12 year who is in 7th grade studying from home. Her school is live on Zoom from 8:30- 3:45 with a break just for lunch.

It will not be possible to stay locked in our small condos working or studying from home while men drill the outside and surround the building while we are supposed to be practicing social distancing.

There are literally hundreds of people locked here at the Waverly and as it is it’s already hard to stay safe when some residents walk around the common areas with no masks.

It is very different to allow work on the Shul or an empty single family home where there are no residents.

Please don’t allow work on the condos until it’s safer and residents have the option to go elsewhere.

On another note, would you consider opening up the dog park? My dog hasn’t been off her leash and able to run in over a month. I’m sure other condo residents have the same problem too. Our dog park has never been a place of gathering.

Thank you for your time,

Fernanda Siqueira
9172 Collins Ave. 409
786-214-1055



**Town of Surfside
Town Commission Meeting**

Town Hall Commission Chambers - 9293 Harding Ave, 2nd Floor
Surfside, FL 33154

DISCUSSION ITEM MEMORANDUM

Agenda #:

Date: April 24, 2020

From: Vice Mayor Tina Paul

Subject: FPL Solar Together Program

Objective – Enroll all Town of Surfside municipal properties in the FPL SolarTogether program.

Consideration – In March 2020, the Florida Public Service Commission approved the FPL SolarTogether program. As the largest community solar program in the United States, SolarTogether removes traditional barriers such as large upfront costs, long-term commitments and has no penalties for unsubscribing. It allows for all FPL customers to go 100% solar with no rooftop installation, maintenance or required insurance.

At the April 21, 2020 Special Commission Meeting, the Commission voted to end CGA Work Authorization No. 117, from July 2019 for Engineering Services for Design-Build Photovoltaic System at the Surfside Community Center.

Surfside has always actively pursued clean energy and environmental initiatives therefore; participating in the FPL SolarTogether program at all Town Facilities will continue these efforts while affording the Town long-term savings.

The FPL SolarTogether program is currently fully subscribed and the waitlist has also been filled.

Recommendation – Direct the Town Manager or designee to contact our Customer Advisor Jose Triana for information on enrolling in the next sign-up for FPL's SolarTogether program.



Thank you for your interest FPL SolarTogetherSM
 The program is fully subscribed and the waitlist is closed.

The SolarTogetherSM program is an easy and affordable option for customers to share in the economic and environmental benefits of Florida based large-scale solar while receiving monthly bill credits on their FPL bill.

At this time, the Commercial, Industrial and Governmental portion of the program is fully subscribed. And, due to overwhelming interest, the waitlist has reached maximum subscription and is closed. We will continue to find new and innovative ways to bring even more solar to Florida and will announce future program opportunities.

Reduce your energy costs while achieving your sustainability goals



Benefits

- Offset up to 100 percent of your energy usage (subject to availability)
- Renewable Energy Credits (RECs) are retired on your behalf
- Receive bill credits immediately



Economics

- Simple payback between 5-7 years
- Fixed monthly subscription rate
- Escalating bill credits
- No maintenance, operational or insurance costs



Terms

- No upfront cost
- No long term contract
- Subscription is transferable to another store or location
- Subscription cannot be sold or transferred to another customer

How the program works

1. Determine your subscription share by selecting the amount of energy you wish to offset – up to 100% of your energy usage can come from solar
2. Calculate your monthly subscription cost based on the fixed subscription rate of \$6.76/kW multiplied by your subscription share
3. Estimate your monthly subscription credit based on your subscription share multiplied by the amount of solar energy produced multiplied by the subscription credit rate

100 kW subscription example

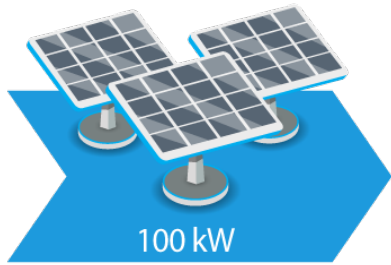

FPL SolarTogether Subscription

100 kW subscription share
x \$6.76/kW fixed subscription rate

Your Monthly Subscription Cost

\$676



Solar Energy Produced

190 hrs per month
x 100 kW subscription share

19,000 kWh solar energy



Subscription Credit

19,000 kWh solar energy produced
x \$0.03405/kWh subscription credit rate/kWh

Your Monthly Bill Credit

\$647

That means you get solar energy for just **\$29** for the month!*

* Illustrative examples presented here for discussion purposes only, program charges and credits will be established per the Florida PSC approved tariff.

And over time, the annual benefits are forecasted to exceed the costs.

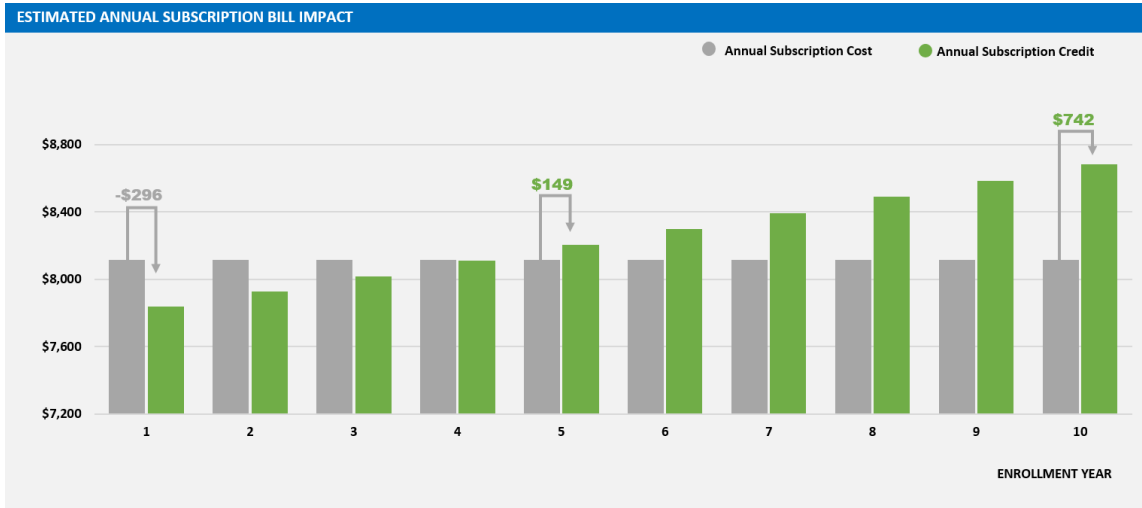

The graph above shows the estimated bill impact over a ten-year period for a 100 kW subscription example. While the annual subscription cost remains the same year after year, due to the fixed nature of the subscription rate, the annual subscription credit grows annually. In the first year of a 100 kW subscription, program participation would cost approximately \$296, which is the difference between the subscription cost of \$8,112 and the credit of \$7,816. By year five, the annual subscription remains \$8,112 and the credit grows to \$8,261, so the credit exceeds subscription cost by \$149. By year ten, the cost of the subscription is still \$8,112 and the credit is now \$8,854 for the year, increasing the credit difference by \$742.

Have Questions?

View our frequently asked questions (<https://www.fpl.com/energy-my-way/solar/solartogether-res/faq.html>).



**Town of Surfside
Town Commission Meeting**

Town Hall Commission Chambers - 9293 Harding Ave, 2nd Floor
Surfside, FL 33154

DISCUSSION ITEM MEMORANDUM

Agenda #:

Date: May 5, 2020

From: Vice Mayor Tina Paul

Subject: Climate Environmental Collective - revised

Objective – Establish a Climate Environmental Collective to deal with climate change as it relates to health, economics, new technologies, and infrastructure innovations for coastal Issues and develop communication campaigns that keep the public informed and promote a strong and healthy town.

Consideration – At the April 14, 2020 Special Town Commission meeting, a decision to abolish the Sustainability and Resiliency Committee was made by the Commission with the decision to include a Sustainability and Resiliency board member on all Town Boards and Committees. While this approach is progressive, the concern of many residents for issues facing a coastal community as a result of Climate Change remains a priority.

The question is, do we want to be progressive or become more radical in our approach?

We've witnessed the triumph of environmental activist Greta Thunberg, who has gained international recognition as a teenager promoting awareness of the reality that humanity is facing an existential crisis arising from climate change. Instead of forming a Task Force or Board or Committee, the Climate Environmental Collective will consist of individuals who work together on ideas and solutions without relying on internal hierarchies.

We can benefit from persons with experience that may include: an Environmental Engineer or Specialist, Water Researcher, Health Practitioner, Marine or Atmospheric Scientist, Oceanographer, Biologist, Economist, Information Technology or Coder, and Graphic Artist. Membership will be diverse and inclusive of residents with all levels of expertise or enthusiasm for Surfside's environment.

The Town Manager recently hired a Resiliency Officer who has been working on specific projects from the previous commission. The new Sustainability members on Town Boards and Committees will work on issues with each Board and Committee; the Climate Environmental Collective can compliment their work. Environmental issues need to be approached as a whole, to assure genuine consideration of climate change, sea-level rise, carbon footprint, renewable energy and green infrastructure strategies with an additional focus on public health. The Collective's meetings do not need paid Consultant experts, or to be televised, and only require a meeting place and minimum staff assistance. It is essential for this Collective to be recognized as an integral part of the Town.

Recommendation – Approve the Climate Environmental Collective because Climate Change and Sea Level Rise is today and if we wait, it will be too late. We are living through Covid-19 now and as a Zoonotic disease it is a direct result of Climate Change and deforestation. The actions needed to combat this pandemic are the same actions we need to confront Climate change. This issue has never been more important, adding a Collective to present ideas and solutions at a minimal cost can actually be invaluable.

RESOLUTION NO. 14 - 2251

A RESOLUTION OF THE TOWN COMMISSION OF THE TOWN OF SURFSIDE, FLORIDA, AMENDING THE FEES TO BE ASSESSED PER PARKING SPACE PROVIDED IN SECTION 90-77 OF THE TOWN CODE WHICH ESTABLISHED A TRUST FUND TO BE ENTITLED THE "TOWN OF SURFSIDE DOWNTOWN PARKING TRUST FUND; REPEALING ALL OTHERS; PROVIDING FOR AUTHORIZATION AND APPROVAL; PROVIDING AN EFFECTIVE DATE.

WHEREAS, Section 90-77 of the Town of Surfside Code of Ordinances established a trust fund to be entitled the "Town of Surfside Downtown Parking Trust Fund" to be maintained and administered by the Town Manager; and

WHEREAS, Resolution No. 10-1991 adopted on December 14, 2010, approved a per parking space fee; and

WHEREAS, the Town has caused to be completed a study of the costs to the Town of providing parking spaces, and has determined that the prior established per space fee is outdated and no longer reflects the actual costs of providing for a single structured off-street parking space; and

WHEREAS, the Town Commission of the Town of Surfside finds it is in the public interest to adopt a Downtown Parking Trust Fund per parking space fee of thirty-eight thousand dollars (\$38,000).

NOW, THEREFORE, BE IT RESOLVED BY THE TOWN COMMISSION OF THE TOWN OF SURFSIDE, FLORIDA, THAT:

Section 1. Recitals. That the above and foregoing recitals are true and correct and are incorporated herein by reference.

Section 2. Approval and Adoption. The Town Commission approves and adopts the Downtown Parking Trust Fund per parking space fee of thirty-eight thousand dollars (\$38,000) for the Town of Surfside that may be payable in accordance with the terms set forth in Sec. 90-77 of the Town of Surfside Code of Ordinances.

Section 3. Repeal of Prior Fees. All other per space parking fees established under Section 90-77 of the Surfside Code of Ordinances are hereby repealed.

Section 4. Authorization. The Town Commission authorizes the Town Manager and Town Attorney to do whatever is necessary to effectuate the terms of this Resolution.

Section 5. Effective Date. This Resolution shall become effective immediately upon its adoption.

PASSED and **ADOPTED** on this 12th day of August, 2014.

Motion by Commissioner Olchyk, Second by Vice Mayor Tourgeman.

FINAL VOTE ON ADOPTION

Commissioner Barry R. Cohen
Commissioner Michael Karukin
Commissioner Marta Olchyk
Vice Mayor Eli Tourgeman
Mayor Daniel Dietch

Yes
Absent
Yes
Yes
Yes



Daniel Dietch, Mayor

ATTEST:

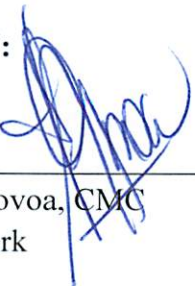

Sandra Novoa, CMC
Town Clerk

**APPROVED AS TO FORM AND
LEGAL SUFFICIENCY FOR THE TOWN OF SURFSIDE ONLY:**



Linda Miller, Town Attorney

TOWN OF SURFSIDE
 BUILDING & ZONING DEPARTMENT/ HOURS 9:00AM - 4:00PM
 9293 HARDING AVENUE
 SURFSIDE, FL 33154
 (305) 361-4863

Permit Number 14-00000509 Date 11/12/15
 Property Address 9540 GB COLLINS AVE
 PARCEL NUMBER: 2 -3-6-0 -0 /3 /ADM6
 FOLIO NUMBER: 1422350070200
 Permit description NEW BUILDINGS-COMMERCIAL
 Property Zoning MULTI-FAMILY
 Permit valuation 13687447

Owner

SHUL OF BAL HARBOUR
 9540 COLLINS AVENUE
 SURFSIDE FL 33154

Contractor

A.V.I CONTRACTORS, INC.
 1442 BLUE JAY CIRCLE
 ATT: VINCENT MISH
 FT. LAUDERDALE FL 33327
 (954) 557-6249

--- Structure Information 000 000 SOCIAL HALL AND LEARNING CENTER
 Construction Type CONCRETE BLOCK
 Occupancy Type COMMERCIAL
 Roof Type BUILT-UP
 Flood Zone AE AT 9 FEET
 Sign Type CONSTRUCTION SIGN
 Fence Type CONSTRUCTION FENCE

Permit NEW COMMERCIAL BLDG/ADDT, ETC
 Additional desc 1&3 STORIES/SOCIAL HALL/CENTER
 Permit Fee 195766.77 Plan Check Fee00
 Issue Date 11/12/15 Valuation 0
 Expiration Date 5/10/16

Qty	Unit Charge	Per	Extension
		BASE FEE	195766.77

Special Notes and Comments

SEPARATE PERMITS MUST BE PULLED FOR THE
 FOR WINDOWS; ROOF; PAVING & CURB CUTS;
 ELECTRICAL; MECHANICAL; PLUMBING; POOL
 FENCE; SIGNS; FIRE & LAWN SPRINKLER
 SYSTEMS; NO CERTIFICATE OF OCCUPANCY
 WILL BE ISSUED UNTIL TEMPORARY STRUCTURE
 USED INCIDENTAL TO THE CONSTRUCTION OF
 THE PRIMARY STRUCTURE HAVE BEEN REMOVED

0094G/1-20-93/AE-8

Other Fees	COUNTY PERMIT FEE	8212.80
	STRUCTURAL ENGINEER FEES	1000.00

Fee summary	Charged	Paid	Credited	Due
Permit Fee Total	195766.77	195766.77	.00	.00
Plan Check Total	.00	.00	.00	.00

TOWN OF SURFSIDE
BUILDING & ZONING DEPARTMENT/ HOURS 9:00AM - 4:00PM
9293 HARDING AVENUE
SURFSIDE, FL 33154
(305)861-4863

Permit Number	14-00000509		Page	2
Other Fee Total	9212.80	9212.80	Date	11/12/15
Grand Total	204979.57	204979.57		.00
				.00

BUILDING DEPARTMENT CLERK: _____

AUTHORIZED SIGNATURE: _____





TOWN OF SURFSIDE

03/23/14 02:10PM

14-509

PERMIT NO.

APPLICATION NO.

AMOUNT DUE

BUILDING PERMIT APPLICATION

2010 FLORIDA BUILDING CODE IN EFFECT

PERMIT TYPE: (Check one) Structural Mechanical Electrical Plumbing Other Roof

JOB ADDRESS: 9540 COLLINS AVE			
OWNER'S NAME: THE SHUL OF BAY HARBOUR INC.			
OWNER'S ADDRESS: 9540 COLLINS AVE.			
CITY: SURFSIDE FL.		PHONE# 305.868.1411	FAX #
FEE SIMPLE TITLE HOLDER'S NAME:		ADDRESS:	
CONTACT PERSON: YANKIE ANDRUSIER PHONE# 347.723.2731			
EMAIL ADDRESS: YANKIE@ownersrepofmiami.com			
CONTRACTOR: A.V.I. Contractors, Inc. (11/10/15)			
MAIL ADDRESS: 2771 Executive Park Drive Suite 2			
CITY: Weston		STATE FL.	ZIP CODE: 33331
PHONE # 954-557-6249		FAX # 954-217-1818	EMAIL: Vincent@AviContractorsInc.com
CERT COMPETENCY: CGC 1508145		STATE REGISTRATION:	
LOT	BLOCK	PRESENT USE:	PROPOSED USE: Synagogue
FOLIO NUMBER:		SUBDIVISION:	
NO. OF STORIES: 3	OFFICES:	FAMILIES:	BEDROOMS: BATHS:
TYPE OF WORK:	ADD <input type="checkbox"/>	NEW <input type="checkbox"/>	ALTER <input type="checkbox"/> REPAIR <input type="checkbox"/> REPLACE <input type="checkbox"/> OTHER <input type="checkbox"/>
VALUE OF WORK: (Total all Trades): \$13,687,447.00		SQ. FT. (TOTAL)	LINEAR FEET
DESCRIBE WORK: ONE AND THREE STORIES SOCIAL HALL AND LEARNING CENTER			
ARCHITECT/ENGINEER'S NAME: SCHAPIRO ASSOCIATES			
ADDRESS: 1150 KANE CONCOURSE, BAY HARBOUR, FL 33154			
PHONE# 305.866.7324		FAX# 305.866.7474	EMAIL: jame@schapiroassociates.com
MORTGAGE LENDER NAME:			

Ext. 212

MIAMI BEACH

Miami Beach failed to collect \$19 million in developer fees for parking

By Joey Flechas

jflechas@MiamiHerald.com

SEPTEMBER 16, 2014 07:06 PM, UPDATED SEPTEMBER 18, 2014 03:21 PM



Officials at Miami Beach City Hall have uncovered past mismanagement of a program that allows developers who can't provide on-site parking to pay the city a fee for every space they can't provide. The city could have collected nearly \$19 million. JOEY FLECHAS MIAMI HERALD STAFF



Listen to this article now

04:14 Powered by [Trinity Audio](#)

In Miami Beach, a town known for its scarcity of parking, city staffers have failed to collect nearly \$19 million in fees from developers — fees that were supposed to be used to improve the city's parking facilities.

City administrators uncovered the problem, which stretches back 25 years, through an eight-month internal review, the results of which were released Tuesday. Administrators will present the findings of the internal investigation to the City Commission Wednesday evening.

Since January, the city's planning department has reviewed processes and procedures in the "fee in

We may use cookies, beacons (also known as pixels), and other similar technologies (together "cookies") to offer you a better experience, serve you more relevant ads, and analyze usage. By continuing to use this application, you consent to the use of cookies in accordance with our Privacy Policy.

ACCEPT COOKIES



Pharrell just dropped \$30 million on sweet ‘quarantine’ digs in Coral Gables: report

That fee, currently set at \$35,000 per space, is supposed to go toward improving the city’s parking facilities. An annual fee is also charged if a change to an existing property requires more parking, like if a restaurant adds more tables. That fee is set at \$700 per year for as long as that use remains.

Local news has never been more important

Subscribe for unlimited digital access to the news that matters to your community.

#READLOCAL

According to a memo sent Tuesday afternoon to the City Commission, the review uncovered issues with billing, accounting and inspection of properties in the program, which led to the city leaving \$18.9 million on the table over the course of the past 20 years. It started with reviewing a sample of 25 accounts in the program at the beginning of this year. The pool ballooned to about 180 accounts after staffers kept finding problems.

The news comes about a week after the Miami Herald reported that [past Miami Beach administrators failed to collect \\$2.7 million in water and sewer connection fees from several hotels and condos](#). It does not appear there is any connection between the two instances of mismanagement.

Officials reviewing the parking fee program also found that the city did little or nothing after three previous internal audits revealed some of the management issues in 1997, 2003 and 2010.

“Management responses for corrective action did not have completion dates and there is no evidence that significant and deliberate steps were taken by any of the departments involved to establish the appropriate checks and balances to prevent recurrence or initiate invoicing of recurring fees to prevent further loss,” reads the memo, prepared by Deputy Planning Director Carmen Sanchez and Assistant City Manager Joe Jimenez.

The one-time fee has increased incrementally over the years. In many cases, records show past planning officials agreed to bill property owners at previous lower rates without explanation. In

We may use cookies, beacons (also known as pixels), and other similar technologies (together "cookies") to offer you a better experience, serve you more relevant ads, and analyze usage. By continuing to use this application, you consent to the use of cookies in accordance with our Privacy Policy.

ACCEPT COOKIES

PAGE 594

financial system.

The review is ongoing.

“Staff has conducted extensive research and has had to reconstruct the history for most of the accounts evaluated,” reads the memo. “As new details come to light and additional information is received the estimated receivable amount may change to include other projects identified at a future date.”

The history of poor management came to light to city officials earlier this year, when Sanchez, hired in late 2013, and Jimenez, who joined the city in May 2013, initiated a review of the program. The current administration has already put some checks and balances in place to fix the problems.

According to the memo, the planning department has invoiced 34 recurring accounts for the current fiscal year, and will start invoicing all active accounts for the upcoming fiscal year, starting Oct. 1. The city has updated its permitting software to keep records of what is charged and owed, hired staff to manage special revenue accounts like the parking impact fee program and, from now on, building permits or certificates of use will not be issued until the fee has been paid.

City administrators did not want to comment for this story before presenting their findings to the City Commission. Administrators will ask the City Commission for direction on how to proceed with uncollected money from current businesses and ones that have closed but still have outstanding balances.

Follow @joeflech on Twitter.

RELATED STORIES FROM MIAMI HERALD

MIAMI-BEACH

Miami Beach to develop plan to recover unpaid developer fees

SEPTEMBER 17, 2014 8:21 PM

MIAMI-BEACH

Miami Beach failed to collect millions in water and sewer fees from new hotels and condos

SEPTEMBER 07, 2014 2:59 PM

MIAMI-BEACH

Miami Beach agrees to increase storm-drainage fees

SEPTEMBER 10, 2014 3:42 PM

MIAMI-BEACH

City commission approves body cameras for employees

SEPTEMBER 10, 2014 7:12 PM

FROM OUR ADVERTISING PARTNERS



How Dogs Cry for Help: 3 Warning Signs Your Dog is Crying for Help
DR. MARTY



Americas #1 Futurist 2020 Prediction Will Stun You
INTERNET REBOOT 2020



MD: If You Have Toenail Fungus, Do This Immediately (Watch)
CLEAR NAIL PLUS

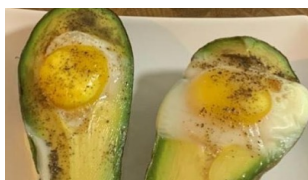

ACCEPT COOKIES

We may use cookies, beacons (also known as pixels), and other similar technologies (together "cookies") to offer you a better experience, serve you more relevant ads, and analyze usage. By continuing to use this application, you consent to the use of cookies in accordance with our Privacy Policy.

COMMENTS ▾



Big crowds at Miami Beach parks, marinas on first weekend of reopening



Food distributions help Miami Beach families

[VIEW MORE VIDEO →](#)

TRENDING STORIES

After six weeks of lockdown, Miamians enjoy first weekend of reopened parks, marinas

UPDATED 9 HOURS 35 MINUTES AGO

Pieces of Halley's Comet will streak across the night sky this week. Here's what to know

UPDATED MAY 02, 2020 02:06 PM

Biden, Warren: There's no oversight of coronavirus relief — because that's what

We may use cookies, beacons (also known as pixels), and other similar technologies (together "cookies") to offer you a better experience, serve you more relevant ads, and analyze usage. By continuing to use this application, you consent to the use of cookies in accordance with our Privacy Policy.

[ACCEPT COOKIES](#)

THIS DAY IN HISTORY

1990

Brooks Koepka, the American golfer, is born.

3 MAY

THIS DAY IN HISTORY

Royal Caribbean falsely blames CDC for keeping crew trapped on its ships, agency says

UPDATED MAY 01, 2020 10:22 PM

After refusing for weeks, Florida releases nursing home records, showing flurry of deaths

UPDATED MAY 02, 2020 06:29 PM

READ NEXT



MIAMI-DADE COUNTY

After six weeks of lockdown, Miamians enjoy first

We may use cookies, beacons (also known as pixels), and other similar technologies (together "cookies") to offer you a better experience, serve you more relevant ads, and analyze usage. By continuing to use this application, you consent to the use of cookies in accordance with our Privacy Policy.

ACCEPT COOKIES

PAGE 597



Saturday brought crowds at Miami-Dade County marinas and parks, which opened Wednesday after weeks of being closed due to coronavirus. At Blackpoint Marina, hundreds of cars lined up to go boating and fishing.

KEEP READING →

Local news has never been more important

#ReadLocal

Subscribe for unlimited digital access to the news that matters to your community.

#READLOCAL

MORE MIAMI BEACH



MIAMI BEACH

Miami Beach rejects beach-opening plan, but new COVID testing site gives leaders hope

UPDATED MAY 01, 2020 09:00 PM



MIAMI BEACH

After Facebook fight draws criticism, Miami Beach commissioner announces \$17K donation

UPDATED MAY 01, 2020 05:05 PM



REAL ESTATE NEWS

Instagram sensation Gianluca Vacchi lists his Miami Beach home for \$10.9M

UPDATED MAY 01, 2020 03:30 PM



MIAMI BEACH

More than 1,550 face-mask warnings issued in Miami Beach parks after reopenings

UPDATED MAY 01, 2020 04:41 PM



MIAMI BEACH

Miami Beach man accused of raping a 16-year-old girl in apartment stairwell

UPDATED MAY 01, 2020 04:31 AM



SPONSORED CONTENT

8 Things You Didn't Realize You Could Do to Pay off Debt

BY THE PENNY HOARDER

Take Us With You

Real-time updates and all local stories you want right in the palm of your hand.



MIAMI HERALD APP →

We may use cookies, beacons (also known as pixels), and other similar technologies (together "cookies") to offer you a better experience, serve you more relevant ads, and analyze usage. By continuing to use this application, you consent to the use of cookies in accordance with our Privacy Policy.

PAGE 598

ACCEPT COOKIES

SUBSCRIPTIONS

- [Start a Subscription](#)
- [Customer Service](#)
- [eEdition](#)
- [Vacation Hold](#)
- [Pay Your Bill](#)

LEARN MORE

- [About Us](#)
- [Contact Us](#)
- [Newsletters](#)
- [News in Education](#)
- [Public Insight Network](#)
- [Reader Panel](#)
- [Archives](#)

ADVERTISING

- [Place a Classified](#)
- [Media Kit](#)
- [Public Notices](#)

COPYRIGHT

COMMENTING POLICY

PRIVACY POLICY

TERMS OF SERVICE

We may use cookies, beacons (also known as pixels), and other similar technologies (together "cookies") to offer you a better experience, serve you more relevant ads, and analyze usage. By continuing to use this application, you consent to the use of cookies in accordance with our Privacy Policy.

PAGE 599

ACCEPT COOKIES



TOWN OF SURFSIDE, FLORIDA

**REQUEST FOR PROPOSALS (RFP)
POINT LAKE CANAL SUBAQUEOUS WATER
MAIN CROSSING TO BISCAYA ISLAND
RFP No. #####-##**

Issue Date: **January** ____, 2020

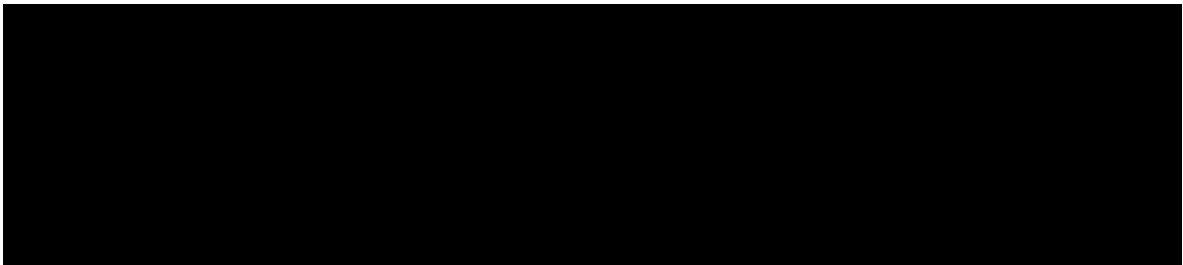

TABLE OF CONTENTS

ARTICLE	PAGE No.
Public Notice – Request for Proposals	3
Article 1 – Definition of Terms	5
Article 2 – Introduction	7
Article 3 – Proposal Instructions	10
Article 4 – Information Required in Proposals	16
Article 5 – Procedure and Criteria for Evaluating Bid Proposals	22
Article 6 – Execution of Agreement and Completion of Work	24
Article 7 – General Information and Administrative Requirements	25
Article 8 – Design Criteria Package <div style="padding-left: 40px;">Exhibit 1 - Location Map of Community Center</div> <div style="padding-left: 40px;">Exhibit 2 - Design Criteria Plans (Exhibit A thru E)</div> <div style="padding-left: 40px;">Exhibit 3 – Recent FPL Bill</div>	26
Article 9 – Proposer’s Acknowledgements	30
Article 10 – Representations	30
FORMS	
FORM 1 – Proposal Checklist	31
FORM 2 - Proposal Cover Sheet	32
FORM 3 – Project Cost Proposal	35
FORM 4 – Proposal Bond – Proposer Surety	37
FORM 5 – Statement of Qualifications & Supplemental Forms	40
FORM 6 – Sworn Statement – Public Entity Crimes	50
FORM 7 – Non-Collusion Affidavit	53
FORM 8 – Non-Discrimination Affidavit	54
FORM 9 – References	55



PUBLIC NOTICE

Request for Proposals (RFP) No. 2020-01 **Design/Build of Community Center Photovoltaic System**

NOTICE IS HEREBY GIVEN that the Town of Surfside is soliciting sealed proposals for the Design/Build of the Community Center Photovoltaic System in Surfside, Florida. Interested firm/individuals (“Proposer (s)”) may pick-up a copy of the Request for Proposals (“RFP”) No. 2020-01 from the Town Clerk’s Office, Town of Surfside, Town Hall, 9293 Harding Avenue, Second Floor, Surfside, Florida, 33154, or may download it from the Town’s website at www.townofsurfside.fl.gov. The RFP contains detailed and specific information about the scope of services, submission requirements, and selection procedures.

One (1) original, five (5) hard copies, and one (1) electronic copy on a USB drive of the completed and executed Proposal must be delivered no later than _____, 2020, at **2:00 PM** (“Submission Deadline”) to the following address:

**Town of Surfside Town Hall
Town Clerk’s Office
9293 Harding Avenue, Second Floor
Surfside, Florida, 33154.**

The Town reserves the right to reject late submissions, in the sole discretion of the Town Manager or his designee.

The envelope containing the sealed Proposal must be clearly marked as follows:

**SEALED PROPOSAL
RFP NO. 2020-01
DESIGN/BUILD OF COMMUNITY CENTER PHOTOVOLTAIC SYSTEM
OPENING DATE AND TIME/SUBMISSION DEADLINE: _____, 2020, at 2:00 PM**

A **Mandatory Pre-RFP Submission Conference** is scheduled for _____, 2020 at **2:00 pm** at the Town of Surfside Town Hall, 9293 Harding Ave., Second Floor, Surfside, Florida 33154. All Proposers planning to submit Proposals are required to attend this meeting. Proposers should allow sufficient time to ensure arrival prior to the indicated time. Proposals from those who have failed to attend will not be accepted. All persons attending the pre-submission conference may ask questions or seek clarification regarding this RFP via the procedures outlined herein.

Any questions or clarifications concerning the proposal specifications must be received by Sandra Novoa, MMC Town Clerk, no later than 5:00 PM, _____, 2020. Any questions regarding RFP No. 2020-01 are to be submitted either in writing directly to Sandra Novoa, Town Clerk, at the following address: 9293 Harding Ave., Second Floor, Surfside, Florida 33154, or via email to: snovoa@townofsurfsidefl.gov. Any questions received by the Clerk after the stated deadline will be disregarded. All questions received by the Clerk prior to the stated deadline shall be answered via an Addendum to this RFP and circulated to all registered Proposers.

The Town shall award the contract in a manner consistent with the Florida statutory requirements for Design/Build public contracts. The Proposer must be a qualified design/build firm as defined in Section 287.055, Florida Statutes. The Town of Surfside intends to enter into a Design/Build Agreement with the successful Proposer for design/build of a roof-mounted Photovoltaic System at the Town's Community Center located at 9301 Collins Avenue, Surfside, Florida 33154.

The Town reserves the right to reject any or all proposals, with or without cause, to cancel this solicitation, to waive technical errors and informalities, and to accept any proposal which best serves the interests of or represents the best value to the Town.

The Town of Surfside hereby provides notice to all proposers of the adoption and imposition of a Cone of Silence for this solicitation, as set forth in Section 3-17 of the Town Code. "Cone of Silence," as used herein, means a prohibition on communication regarding a competitive bid or solicitation for a purchase exceeding \$25,000.00, including but not limited to, a particular request for proposal ("RFP") between: (1) A potential respondent, vendor, service provider, proposer, bidder, lobbyist, or consultant, and (2) The Town commissioners, Town's staff including, but not limited to, the Town Manager and his or her staff, any member of the Town's selection or evaluation committee. Please contact the Town Clerk and/or Town Attorney with any questions on the Cone of Silence.

Date Issued: _____, 2020

Request for Proposals (RFP) No. 2020-01
Design/Build of Community Center Photovoltaic System

INSTRUCTIONS

ARTICLE 1
DEFINITION OF TERMS

The terms defined in this Article and the Design/Build Agreement shall apply to all documents contained in the proposal and contract documents for this project. If a conflict exists, the definitions in the Design/Build Agreement supersede definitions provided in the proposal and contract documents.

- 1.1 “Addenda” or “Addendum” mean a written modification to this RFP issued by the Town covering changes, additions, or reductions in the terms of this RFP.
- 1.2 “Amendment” means a written modification to the Contract Documents covering changes, additions, or reductions in the terms of the Contract Documents.
- 1.3 “Bidder” or “Proposer” means a person or entity that timely submits a responsive Project proposal or bid.
- 1.4 “Consultant” or “Project Consultant” both shall be that certain party that the Town may engage to be an owner’s representative for the Project.
- 1.5 “Contract Documents” means this RFP, the Design/Build Agreement, Design Criteria Package, the Plans and Specifications and all exhibits and documents related thereto or contemplated thereby, as well as all Addenda and Amendments related to each with respect to the Project and all changes to said documents issued by the Town.
- 1.6 “County” means Miami-Dade County.
- 1.7 “Day” means consecutive days of the week or month without regard to weekends or holidays.
- 1.8 “Design/Builder” or “Design/Build Firm” means the successful Proposer on this Project who is qualified under Section 287.055, Florida Statutes.
- 1.9 “Design/Build Agreement” means that agreement to be entered into between the Town and the successful Proposer for the Work. The form of the Design/Build Agreement will be available to all proposers in advance of the Submittal Date on the Town’s website www.townofsurfsidefl.gov and/or issued by Addendum to this RFP.

- 1.10 “Design Criteria Package” shall mean the design/build specifications and criteria for the Project prepared by the Town’s Design Criteria Professional as specified in Section 287.055, Florida Statutes, and attached as Exhibits 1 and 2.
- 1.11 “Design Criteria Professional” shall mean the professional engineer preparing the Design Criteria Package, as specified in Section 287.055, Florida Statutes.
- 1.12 “Design Services” are all design services performed by and required of the Design/Builder pursuant to this RFP and the Contract Documents and includes services performed by the Design/Builder’s Subconsultants.
- 1.13 “FDOT” means the Florida Department of Transportation.
- 1.14 “Guaranteed Maximum Price” means the lump sum price for the Work, and is the maximum amount the Town shall be required to pay the Design/Builder for the performance of all obligations described in the Contract Documents.
- 1.15 “Payment Bond” shall be in the form required in this RFP.
- 1.16 “Performance Bond” shall be in the form required in this RFP.
- 1.17 “Project” means the design and construction, in accordance with this RFP and the Contract Documents, of the Community Center roof-mounted Photovoltaic System.
- 1.18 “Project Cost Proposal” means the guaranteed maximum price for which the Proposer offers to perform the Work, as described in the Contract Documents in the form attached hereto as Form “3”.
- 1.19 “Project Location” or “Project Site” means the area where the Project is to be constructed, as shown on Exhibit 1 (Location Map of Community Center located at 9301 Collins Avenue, Surfside, Florida).
- 1.20 “Proposal/Bid Proposal” means the Technical Proposal and the Project Cost Proposal submitted together by the Proposer in response to this RFP.
- 1.21 “Proposal Security” or “Proposal Bonds” shall mean a cashier’s check or bond submitted by a Proposer in the form attached hereto as Form “4”.
- 1.22 “RFP” means this Request for Proposal.
- 1.23 “Selection Committee” shall be appointed by the Town Manager and shall review and evaluate responsive Proposals.
- 1.24 “Short Listed Firms” shall be the top Proposers recommended by the Selection Committee to the Town Manager and/or Town Commission.

- 1.25 “Short Listed Firm’s Proposal” or “Short Listed Firm’s Presentation” shall both mean all documents submitted by a Short Listed Firm, and that firm’s oral presentation.
- 1.26 “State” shall mean the State of Florida.
- 1.27 “Subconsultant” means any person or entity, other than Design/Builder’s own employees, employed or retained by, or under contract with Design/Builder to perform a portion of the Design Services under this RFP and the Contract Documents.
- 1.28 “Subcontractor” means any person or entity, other than the Design/Builder’s own employees, employed or retained by, or under contract with the Design/Builder to perform the non-design portion of the Work under this RFP and the Contract Documents.
- 1.29 “Technical Proposal” shall mean all information required to be submitted by the proposer for this RFP to be considered responsive, except the Project Cost Proposal.
- 1.30 “Town” or “Owner” means the Town of Surfside, a Florida municipal corporation.
- 1.31 “Town’s Representative” shall be the person designated by the Town as the Town’s contact person.
- 1.32 “Work” includes all aspects of the design and construction project proposed in this RFP, the Contract Documents and other bidding documents.

ARTICLE 2
INTRODUCTION, BACKGROUND, PROJECT DESCRIPTION,
AND SCOPE OF SERVICES

2.1 INTRODUCTION

- 2.1.1 The Town of Surfside, Florida (“Town”), a municipality located in Miami-Dade County, Florida, requests qualified Design/Build Proposers (“Proposers”) to submit proposals to design and build a roof-mounted Photovoltaic System (also known as solar panels) in the Town’s Community Center located at 9301 Collins Avenue, Surfside, Florida 33154.
- 2.1.2 The Town desires to contract with a qualified Design/Build Firm to design and construct the Project.
- 2.1.3 The Town intends to award the Design/Build Agreement to a qualified entity that the Town Commission determines to be in the best interest of and most advantageous to the Town.

2.1.4 The Work required under this RFP is defined in this RFP, which includes the Design Criteria Package, and the Contract Documents.

2.2 **BACKGROUND.** The Town is located on a barrier island in northeast Miami-Dade County, Florida, situated between Miami Beach to the south and Bal Harbour Village to the north, and is bounded on the east by the Atlantic Ocean, on the west by Atlantic Intracoastal Waterway, on the south by 87th Terrace, and on the north by 96th Street. The Town’s standards stress high-quality visual corridors to the ocean, with access to the ocean, as well as a focus on protecting the environment, providing landscaping, and developing aesthetically attractive structures.

2.3 **PROJECT DESCRIPTION.** The project site is the Town Community Center located at: 9301 Collins Avenue, Town of Surfside, Florida 33154. The solar system shall be comprised of an array of photovoltaic panels and electrical equipment components capable of generating a minimum of 93.6 kWdc to maximize savings.

Currently The Town of Surfside Community Center uses 396,960 kWh annually. The energy usage is as follows:

Month	Energy Usage (kWh) per FPL Billing
December 2018	28,920
January 2019	27,960
February 2019	31,320
March 2019	32,640
April 2019	34,560
May 2019	37,080
June 2019	39,720
July 2019	36,960
August 2019	34,200
September 2019	37,560
October 2019	28,440

Refer to Exhibit 3 for recent FPL Bill

2.4 SCOPE OF SERVICES.

The successful Design-Build Proposer shall design, permit, and construct the improvements necessary for:

- 1) The installation of a roof-mount solar photovoltaic system at the site address. The solar system shall be comprised of an array of photovoltaic panels and electrical equipment components generating a minimum of 93.6 kWdc to maximize savings.

- 2) The structural installation of the solar panels and components to the existing building roof.
- 3) The proposer shall develop a design for a new photovoltaic system. Not all locations identified need to be utilized. It is the responsibility of the proposer to assess the building structural integrity, roof condition, and shading limitations.
- 4) Mounting system shall limit roof penetrations or be fully ballasted. Mounting system design needs to meet applicable local building code requirements with respect to snow, wind, and earthquake factors. Solar system installation must not void the roof warranty.
- 5) Roof conduit penetrations shall be minimized and the new PV electrical equipment shall fit into the existing electrical room.
- 6) System shall be fixed tilt with an orientation that maximizes annual savings.
- 7) Monitoring of system performance and providing public education and outreach is an important element. The Town of Surfside will favor a proposal that includes a turnkey monitoring system that can be integrated into the Town of Surfside's computer system for display on the Town of Surfside website. The system should display and analyze historical and live solar electricity generation data. Additionally, the regularly collected data should reflect, but not be limited to, the following:
 - Average and accumulated output (kWh/kW and total kWh)
 - Capacity factor
 - Air quality emissions averted (and real world equivalents conversion)
- 8) Provide operation and maintenance of the entire solar electric system for 20 years. Operations and maintenance services shall include:
 - Online monitoring
 - Performance monitoring, notification, and troubleshooting – must have personnel available to notify Town of Surfside of an outage or decrease in system production
 - Corrective maintenance to mitigate any risk to the system or minimize down time
 - System Performance Reports that compares actual production to predicted production
 - Preventative maintenance and inspections to identify and fix problems before they occur, including infrared photography for hot spots, manufacturer recommended maintenance, hardware torque checks, and array cleanings

The successful proposer shall prepare and submit design plans, renderings, technical specifications, and materials/PV components-package shop-drawings as necessary to adequately define and portray a fully functional, code-compliant, and operational PV system, and shall

subsequently apply for and obtain all necessary permits required to complete the installation and operation of the system and all of its components. The successful proposer must have worked with Florida Power and Light (FP&L) regulations and have established onsite safety standards.

The design plans shall be submitted for review at 30%, 60%, 90%, and 100%. The technical specifications shall be submitted for review at 60%, 90%, and 100%. The design specifications and plans shall be submitted for review to the Town's Director of Public Works for prior to the filing of permit applications. Such documents shall adequately demonstrate to the Director of Public Works that the PV components, controls, appurtenances, and interconnections will provide a fully functional and controllable system which will operate in accordance with the Town's intentions, as outlined herein. After approval of the products/systems by the Director, no substitutions of materials, systems, or components will be allowed without prior approval of the Director. Once the plans have been approved by the Town's Director of Public Works, they shall be submitted to the Building Department and any other agency having jurisdiction for approval and construction permitting. All permit fees and associated costs for pursuing and obtaining required approvals and permits shall be the responsibility of the Proposer and shall be included in the Proposer's proposal price submitted in response to this RFP.

All work shall be performed and completed in compliance with the National Electric Code (NFPA 70), the Florida Building Code, Miami-Dade County Code, Town of Surfside Charter and Code, and all other applicable codes and standards governing the work. The applicable edition of each code shall be that edition which is adopted and in effect at the time of filing of the last permit application governed by each code or standard.

All permit fees and associated costs for obtaining required approvals and permits for the Work shall be the responsibility of the Proposer and shall be included in the Proposer's Cost Proposal submitted in response to this RFP.

ARTICLE 3 PROPOSAL INSTRUCTIONS

- 3.1 Copies of this RFP may be obtained from the Town. Proposers who obtain copies of this Proposal from sources other than the Town risk not receiving Addenda, since their names may not be included on the list of firms participating in the process for this particular RFP.
- 3.2 **CONE OF SILENCE.** Notwithstanding any other provision of these specifications, the provisions of Town "Cone of Silence" are applicable to this transaction. The "Cone of Silence", as used herein, means a prohibition on any communication regarding a particular Request for Proposal (RFP), Request for Qualification (RFQ), or bid, between a potential vendor, service provider, contractor, bidder, lobbyist, or consultant, and the Town Commission, Town's professional staff including, but not limited to, the Town

Manager and his or her staff, any member of the Town's selection or evaluation committee.

The Cone of Silence shall be imposed upon each RFP, RFQ, and bid after the advertisement of said RFP, RFQ, or bid.

The Cone of Silence shall terminate at time the Town Manager makes his or her written recommendation to the Town Commission. However, if the Town Commission refers the Manager's recommendation back to the Manager or staff for further review, the Cone of Silence shall be re-imposed until such time as the Manager makes a subsequent written recommendation.

The Cone of Silence shall not apply to:

1. Oral communications at pre-proposal/pre-bid conferences.
2. Oral presentations before selection or evaluation committees.
3. Public presentations made to the Town Commission during any duly noticed public meeting.
4. Communications in writing at any time with any town employee, unless specifically prohibited by the applicable RFP, RFQ, or bid documents. The bidder or proposer shall file a copy of any written communication with the Town Clerk. The Town Clerk shall make copies available to any person upon request.
5. Communications regarding a particular RFP, RFQ, or bid between a potential vendor, service provider, contractor, bidder, lobbyist or consultant and the Town's Purchasing Agent or Town employee designated responsible for administering the procurement process of such RFP, RFQ or bid, provided the communication is limited strictly to matters of process or procedure already contained in the corresponding solicitation document.
6. Communications with the Town Attorney and his or her staff.
7. Duly noticed site visits to determine the competency of bidders regarding a particular bid during the time period between the opening of bids and the time the Town Manager makes his or her written recommendation.
8. Any emergency procurement of goods or services pursuant to Town Code.
9. Responses to the Town's request for clarification or additional information.
10. Contract negotiations during any duly noticed public meeting.

11. Communications to enable Town staff to seek and obtain industry comment or perform market research, provided all communications related thereto between a potential vendor, service provider, contractor, bidder, lobbyist, or consultant and any member of the Town's professional staff including, but not limited to, the Town Manager and his or her staff are in writing or are made at a duly noticed public meeting.

Please contact the Town Attorney for any questions concerning Cone of Silence compliance.

Violation of the Cone of Silence by a particular bidder or proposer shall render any RFP award, RFQ award, or bid award to said bidder or proposer voidable by the Town Commission and/ or Town Manager

- 3.3 **MANDATORY PRE-SUBMITTAL CONFERENCE.** A Mandatory Pre-Submittal Conference is scheduled for _____, 2020 at 2:00 pm at the Town of Surfside Town Hall, Second Floor, 9293 Harding Avenue, Surfside, Florida 33154. All Proposers planning to submit Proposals are required to attend this meeting. Proposers should allow sufficient time to ensure arrival prior to the indicated time. Proposals from those who have failed to attend may not be accepted.

- 3.4 **ADDITIONAL INFORMATION OR CLARIFICATIONS; ADDENDA.** Requests for additional information or clarifications must be received by **Sandra Novoa, M.M.C. Town Clerk, no later than 5:00 PM, on _____, 2020.** Any questions regarding this RFP No. 2020-01 are to be submitted either in writing to the Town Clerk's Office, Surfside Town Hall, 9293 Harding Ave., Second Floor, Surfside, Florida 33154, or via e-mail directly to Sandra Novoa, Town Clerk, snovoa@townofsurfsidefl.gov, in accordance with the deadline for receipt of questions, as also specified in the Public Notice Section of this RFP. The request for additional information and clarification must contain the RFP number and title, Proposer's name, name of Proposer's contact person, address, phone number, and e-mail. No verbal communications shall be binding; only written Addendum from the Town shall be binding. The Town will issue responses to inquiries and any other corrections or amendments it deems necessary in written addenda issued prior to the Proposal deadline. All persons attending the mandatory pre-bid conference will receive the Town's responses. Proposers should not rely on any representations, statements or explanations other than those made in this RFP or in any written addendum to this RFP. Where there appears to be a conflict between the RFP and any addenda issued, the last addendum issued shall govern and prevail.

- 3.5 **SUBMITTAL OF PROPOSAL.** The submittal shall consist of one sealed Proposal package. The package shall include the Project Cost Proposal in a separate sealed envelope and a complete original Technical Proposal. Each Proposer shall submit one (1) original, and five (5) additional complete hard copy proposals, and one (1) electronic copy on a USB drive. Proposals shall be as thorough and detailed as possible so that the Town may properly evaluate the capabilities of respective firms to provide the required design/build services. All submittals must meet or exceed the specifications and requirements provided in the **Design Criteria details in Exhibit 2.** Any deviations must be

submitted in writing for approval. No exceptions will be made after the Design/Build Agreement is executed. All proposals submitted to the Town must be delivered no later than _____, 2020 at 2:00 PM (“Submission Deadline”)to the following address.

**Town of Surfside Town Hall
Town Clerk’s Office
9293 Harding Avenue, Second Floor
Surfside, Florida 33154**

The Town reserves the right to reject late submissions, in the sole discretion of the Town Manager or his designee.

The envelope containing the sealed Proposal must be clearly marked as follows:

**SEALED PROPOSAL
RFP NO. 2020-01
DESIGN/BUILD OF COMMUNITY CENTER PHOTOVOLTAIC SYSTEM
OPENING DATE AND TIME/SUBMISSION DEADLINE: _____, 2020 at 2:00 PM**

No extensions to the submission due date will be granted and Proposals received after this time will be returned unopened.

- 3.5.1 Proposal Packaging - Both parts of the Proposal – Technical Proposal and Project Cost Proposal - shall be submitted in separate opaque plain sealed envelopes, parcels, boxes, or other secure packaging. The outside of the sealed packaging must clearly indicate the Proposer’s name, address, and the name and telephone number of the Proposer’s specific contact person; and must designate whether the package contains the Technical Proposal or the Project Cost Proposal. Any and all packaging must clearly and distinctly identify the Proposal by the RFP number and name: **“RFP No. 2020-01 Design/Build of Community Center Photovoltaic System – “Technical Proposal” and “RFP No. 2020-01 Design/Build of Community Center Photovoltaic System – “Project Cost Proposal”**.
- 3.5.2 For the Project Cost Proposal, if a cost discrepancy exists between the item subtotal costs and the Guaranteed Maximum Price, the value entered as Guaranteed Maximum Price will take precedence. If a cost discrepancy exists between the written value for the Guaranteed Maximum Price and the numerical value, the written value will take precedence.
- 3.5.3 All Proposals shall be submitted on 8½ by 11 paper, type written on one side only with one (1) inch margins on all sides. Each copy of the Technical Proposal package must be individually bound.
- 3.5.4 An officer who is legally authorized to bind the proposing entity into a contractual relationship must sign the Proposals.

- 3.5.5 The Selection Committee will perform an initial review of all submitted Proposals to determine responsiveness. Any Proposals deemed non-responsive will be disqualified and not subject to further review. In determining responsiveness, the Selection Committee and/or Town Commission reserves the right to waive a non-material informality or irregularity.
- 3.5.6 This Proposal is irrevocable for one hundred twenty (120) Calendar Days from the RFP Submission Deadline.
- 3.5.7 The Proposer agrees that should the Proposer be selected to perform the Work, the Proposer shall be bound to perform the Work as specified in the Project Cost Proposal whether or not the Town awards all or a portion of the Work

3.6 CALENDAR OF IMPORTANT DATES

The Town’s proposed calendar of events is listed below. This calendar is for the Town’s and Proposer’s preliminary planning use only and is subject to change.

Date	Event
_____, 2020	Public Notice
_____, 2020, 2:00 pm	Mandatory Pre-Proposal Conference
_____, 2020	Last day to submit questions/clarifications
_____, 2020	Submission Deadline: Proposal due to Town Clerk no later than 2:00 PM
_____, 2020 week	Selection Committee meets to open Technical Proposals and eliminate non-responsive Proposals
TBD	Proposals Under Review. Selection Committee meets to publicly evaluate Proposals and produce Short List
TBD	Presentation by Short-Listed Firms (if required)
TBD	Town Commission Action - Final Ranking - Authorization to negotiate issued to Town Manager
TBD	Town Commission Action – Award of

Date

Event

Design/Build Agreement

Note:

Proposers may be requested to make public presentations at any time during the evaluation process. Public presentations are for the purpose of clarifying Proposals prior to scoring by the Selection Committee or prior to final selection by the Town Commission.

3.7 ELIGIBILITY

3.7.1 All potential Design/Build Firms must be qualified pursuant to Section 287.055, Florida Statutes.

3.7.2 Contractors and Subcontractors must meet additional licensing, certification, and bonding requirements as specified in the Design/Build Agreement and elsewhere in this RFP.

3.7.3 Proposers must submit evidence of proper State and County licensing for all contract work, professional services, and other services required under this RFP prior to the execution of the Design/Build Agreement and shall attach such documentation as attachments to the **Statement of Qualifications (See Form 5)** described below for the purposes of evaluation during the selection process as defined by this RFP.

3.8 NON-RESPONSIVE PROPOSALS

Proposals found to be non-responsive shall not be considered. Proposals may be rejected if found to be in nonconformance with the requirements and instructions herein contained. A Proposal may be found to be non-responsive by reasons, including, but not limited to, failure to utilize or complete prescribed forms, conditional proposals, incomplete proposals, indefinite or ambiguous proposals, failure to meet deadlines and improper and/or undated signatures. Other conditions which may cause rejection of proposals include evidence of collusion among Proposers, obvious lack of experience or expertise to perform the required Work, or meet financial obligations on previous contracts. Proposals will also be rejected if not delivered or received on or before the Submission Deadline.

3.9 WAIVER OF IRREGULARITIES

The Town may waive non-material informalities or irregularities in Proposals received where the correction or waiver of which is not prejudicial to other Proposers. Non-material irregularities are defined as those that will not have an adverse effect on the Town's interest and will not affect the price of the Proposals by giving a Proposer an advantage or benefit not enjoyed by other Proposers.

Proposers shall identify separately all innovative aspects of their proposal. Innovation should be limited to Design-Builder's means and methods, approach to Project, use of new products, new uses for established products.

3.10 TOWN OPTIONS

The Town may, at its sole and absolute discretion, reject any or all Proposals, re-advertise this RFP, postpone or cancel this RFP process at any time, or waive any irregularities in this RFP or in the Proposals received as a result of this RFP.

The determination of the criteria and process whereby Proposals are evaluated, the decision as to who shall receive the Design/Build Agreement award, or whether an award shall ever be made as a result of this RFP, shall be the sole and absolute discretion of the Town.

The submittal of a Proposal will be considered by the Town as constituting an offer by the Proposer to provide the Work described in this RFP.

3.11 RULES, REGULATIONS, AND REQUIREMENTS

All proposers shall comply with all laws, ordinances, and regulations of any Federal, State of Florida, Miami-Dade County, or Town government applicable to submitting a response to this RFP and to providing the Work described herein.

ARTICLE 4 INFORMATION REQUIRED IN PROPOSALS

In order to be deemed responsive, each Proposer shall submit the following information and documents with their proposal:

4.1 **Transmittal Letter:** Each Proposer shall submit a transmittal letter signed by an officer authorized to represent, bid, commit and negotiate for the Proposer. The transmittal letter shall state that the Proposer has read and reviewed the RFP's terms and conditions, and accepts such terms and conditions as binding and enforceable. In addition, the letter shall acknowledge receipt and acceptance of all Addenda to the RFP. The transmittal letter shall state that the Proposer's Proposal is valid for one hundred twenty (120) days from the date of its submission.

4.2 **Proposal Cover Sheet:** Provide the information requested in the **Proposal Cover Sheet attached hereto as Form "2"**.

4.3 **Proposer's Statement of Qualifications:** Provide the information requested in the **Proposer's Statement of Qualifications attached hereto as Form "5"**, including the following:

- 1) The Name and address of company/firm, including, but not limited to, a business overview, financial state of the business, annual revenue for past two years, and

names and addresses of all persons having financial interest in firm and key managerial personnel.

- 2) Proof of authorization from the Florida Secretary of State for the prime design-build firm and all sub-contractors and sub-consultants to transact business in Florida, together with a copy of all applicable licenses and permits required for the Work. Proposer must be fully licensed with all required State and/or local licenses and permits to perform the Work and all services.
- 3) Resumes, with job descriptions and other detailed qualification information, for all key personnel who will be assigned to this project, including any key personnel of sub-consultants and sub-contractors.
- 4) Description of the Proposer's (including sub-consultants' and sub-contractors') experience in the application of Photovoltaic (PV) Technology and implementation of the technical requirements as defined in the Project's Scope of Services. Proposers shall describe and demonstrate their successful deployment of the systems described in the Scope of Services or on systems of similar or greater complexity (illumination scenes and lighting synchronization) to that requested in this proposal.
- 5) Description of the experience, qualifications, and other vital information, including relevant experience on previous similar projects, of all key personnel, including those of sub-consultants and sub-contractors, who will be assigned to this project.
- 6) Detailed description of comparable contracts as they pertain to the Scope of Services similar to that requested herein, which the Proposer and Subcontractor has either ongoing or completed within the past five years. The description should identify for each project: (i) client, (ii) a complete description of work, (iii) total dollar value of the contract, (iv) dates covering the term of the contract, (v) client contact person and phone number, (vi) statement of whether Proposer was the prime contractor or subcontractor, and (vii) the results of the project. Where possible, list and describe those projects performed for government clients or similar size private entities (excluding any work performed for the Town of Surfside).
- 7) List all contracts which the Proposer has performed for the Town of Surfside. The Town will review all contracts the Proposer has performed for the Town. As such, the Proposer must list and describe all work performed for the Town of Surfside and include for each project:

- a. Name of the Town Department which administers or administered the contract;
 - b. Description of work;
 - c. Total dollar value of the contract;
 - d. Dates covering the term of the contract;
 - e. Town contact person and phone number;
 - f. Statement of whether Proposer was the prime contractor or subcontractor; and
 - g. Results of the project.
- 8) Project approach (as outlined in Section 2.4 above) including conceptual renderings, schematic diagrams, technical specifications, shop-drawings or cut sheets of all integral parts (solar panels, control system, etc.), phasing plan, and project schedule. Cut sheets and shop drawings will not count against the page limit.
- 9) The Total Project Cost or price to the Town.

4.4 **Subcontractor and Subconsultant Information:** Provide Subcontractor and Subconsultant information in Form 5, including, but not limited to the identification of any Work, which exceeds either twenty percent (20%) of the design fee or twenty percent (20%) of the construction cost presented in the Project Cost Proposal. Identify the Subcontractors and Subconsultants, the Work to be subcontracted, and the management controls to be used to assure the Subcontractor's or Subconsultant's performance. Subcontracted and Subconsulted Work which is less than twenty percent (20%) of the Project Cost Proposal does not need to be disclosed.

4.5 **References:** For the Proposer, provide all design-build clients in the last five (5) years whether the project is complete or ongoing. For each client reference, include the names, organizational affiliations, titles, addresses and telephone numbers. Also, provide client references for all design and/or construction/installation of photovoltaic systems or projects similar to the one proposed for the last five (5) years whether the project is complete or ongoing. Identify the specific services provided, the periods for which such services were provided and information relative to this proposed activity. (Use a separate sheet).

4.6 **Technical Proposal:** Submit Proposal complying with Article "2" and "8" (Exhibit 3 – Design Criteria).

4.7 **Public Entity Crimes Statement:** Executed form attached hereto as Form "6".

4.8 **Project Schedule:** Provide a time schedule, which shall include design, permitting and construction time, with pertinent milestones, and start-up time.

- 4.9 **Project Organization and Management:** Identify the key personnel on the Proposer's project team, and their specific areas of expertise and responsibility. Provide a brief biographical sketch or resume of their professional qualifications and experience, including educational and licensing information.
- 4.10 **Project Cost Proposal:** Provide Project Cost Proposal in a clearly marked, separate, sealed envelope from the Technical Proposals, including specific costs for the following.
- 4.10.1 Design and construction price or total Project cost for the Work.
- 4.10.2 The Proposer will provide sufficient detail and breakdown of costs in a Schedule of Values to support their Project Cost Proposal.
- 4.10.3 All Project Cost Proposals are to include applicable local and state sales tax.
- 4.10.4 The Project Cost Proposal shall include a Guaranteed Maximum Price for the completion of the Work.
- 4.11 **Proposal Security.**
- 4.11.1 Each Proposal shall be accompanied by Proposal Security in the amount of five percent (5%) of the Project Cost Proposal.
- 4.11.2 Proposal Securities, if other than Bonds, will be returned to unsuccessful Proposers within fifteen (15) days following notice of the rejection of Proposals and that of the Design/Builder(s) shall be returned upon the execution of the Design/Build Agreement and delivery of all requirements for commencement of the Work, including bonds and insurance.
- 4.11.3 Should the Proposer selected by the Town Commission as the Design/Builder make any material misrepresentations or false statements in its Proposal, the amount of the Proposal Security shall be forfeited to the Town as liquidated damages, and not as a penalty.
- 4.12 **Insurance:** Proposer shall submit evidence of insurability from their insurance carrier for such types and minimum amounts of insurance as follows.
1. Workers' Compensation Insurance – Statutory limits and Employer's Liability Insurance - \$1,000,000
 2. Professional Liability (Errors and Omissions) Insurance –
 - \$1,000,000 per occurrence, \$2,000,000 aggregate on dedicated project limits with a deductible (if applicable) not to exceed \$25,000.00 per claim (audited financial statements required). The certificate of insurance shall reference any applicable deductible.

- Claims made on the policy must have an extended coverage reporting period of two (2) years past the coverage completion date.
 - For Deductible programs or Self Insured Retention programs an Irrevocable Letter of Credit or performance Bond for amount of SIR/Deductible is required.
3. Commercial General Liability Insurance – preferably written on an occurrence form with \$1,000,000 for each occurrence, to include contractual liability, personal & advertising injury, and products/completed operations, combined single limit for Bodily Injury Liability and Property Damage Liability, in the amount of Two Million Dollars (\$2,000,000) aggregate. .
 4. Automobile Liability Insurance – \$1,000,000 combined single limit bodily injury & property damage.

The successful Proposer must submit, prior to signing of the Design/Build Agreement, among other things, a Certificate of Insurance including the Town as an additional insured for Commercial General Liability and Auto Liability Insurance. The Successful Proposer shall guarantee all required insurance remain current and in effect throughout the term of Design/Build Agreement.

- 4.13 Performance Bonds and Payment Bonds shall be issued by approved bonding companies, to be acceptable to the Town, will be limited to those authorized to transact business in the State of Florida, having a resident agent in the State of Florida, and meeting the following requirements and/or limits: Surety shall be rated “B” or better as to the strength by Best’s Insurance Guide or Surety shall be listed on the U.S. Treasury Department’s list of acceptable sureties for federal bonds or bonding limits shall not exceed 20% of its policy surplus (capital & surplus) as listed in Best’s Insurance Guide; and, Surety shall have been in business and have a record of successful and continuous operation for at least five (5) years; and, all bonds shall contain all provisions required by Section 255.05, Florida Statutes. Said Bonds shall guarantee the performance of the Agreement and as security for the payment of all persons performing labor and furnishing materials in connection with the Agreement. The Performance Bond and Payment Bond shall be issued by the Surety Company on the forms provided within the Proposal Documents. No other forms will be acceptable. These forms are as follows.

4.13.1 **Design/Builder’s Performance Bond:** Required in the amount of one hundred percent (100%) of the Guaranteed Maximum Price.

4.13.2 **Design/Builder’s Payment Bond:** Required in the amount of one hundred percent (100%) of the Guaranteed Maximum Price.

4.14 **The Project Cost Proposal:**

- 4.14.1 Shall list each item of Work including design services and construction work for which payment will be made. A schedule of values for construction shall be included with the Project Cost Proposal to facilitate payment based on Work completed to date. No payment will be made for any items other than those listed in the Project Cost Proposal.
- 4.14.2 Required items of Work and incidentals necessary for the satisfactory completion of the Project which are not specifically listed in the Project Cost Proposal or included in one of the items list in the Project Cost Proposal shall be considered as incidental to the Project. All costs thereof, including the Proposer's overhead costs and profit, shall be considered as included in the schedule of values for the Project Cost Proposal.
- 4.14.3 Project Work includes furnishing all labor, equipment, tools and materials and performing all operations required to design, build, implementation and operation of the Community Center photovoltaic system.

ARTICLE 5
PROCEDURE AND CRITERIA FOR EVALUATING PROPOSALS

5.1 The Town will utilize a Selection Committee appointed by the Town Manager that will score and assign points during the evaluation and recommendation process. The Selection Committee will initially review the Technical Proposals to determine responsiveness and reject any Proposals deemed non-responsive. The Selection Committee will review and evaluate the responsive Technical Proposals and shall evaluate each of the Proposals based on all information required and submitted. After the Technical Proposals are evaluated, the Cost Proposals will be opened and evaluated. Proposals will be scored. The Selection Committee will place and rank not less than three (3) Proposers, provided that at least three (3) responsive Proposals have been received, on a list, which will become the Short Listed Firms. If less than three (3) Proposers submit Proposals, then the number of responsive Proposals received shall become the Short Listed Firms. The Town Manager shall submit the Short Listed Firms to the Town Commission with recommendation(s) for selection. The Town Commission shall review the Short Listed Firms' rankings and recommendations, and may require the Short Listed Firms to prepare oral presentations to the Town Commission. The Town Commission will then direct staff to negotiate a Design/Build Agreement with the selected proposer. The Town Commission may award the Design/Build Agreement from the Short Listed Firms as it determines to be in the best interest of the Town and most advantageous. Alternatively, the Town Commission may reject any or all Proposals or cancel this solicitation.

5.2 The Proposer shall present a comprehensive project plan for completing the Work. The plan shall address all significant design, construction and maintenance issues and constraints and shall demonstrate efficient use of manpower, materials, equipment, construction schemes, and techniques for completing the Project.

The minimum information to be included is as follows: Anticipated Award Date, Design Schedule, Design Reviews by the Town, Permitting, Start of Construction, Construction Milestones, Construction Phasing and Methods, conditional acceptance for all Work including punch list items, and final acceptance/completion date.

5.3 The Selection Committee shall review and evaluate the Proposals using the evaluation criteria. The Selection Committee, during its evaluation process, reserves the right to contact references and to verify information submitted by any Proposer. The Selection Committee may also request clarification or information from the Proposers. The evaluation and point assessment for each proposal shall be based on the following criteria for a maximum total of 100 points.

- 5.3.1 Firm Qualifications/Project Experience: **20 points**
- Relative financial strength of Proposer.
 - Ability to secure maintenance, performance and payment bonds.
 - Proposer’s experience and past performances in providing proposed design/build services, including demonstrating relevant design and construction experience, existing and past projects.
 - Reference verification.
 - Familiarity with local conditions.
- 5.3.2 Project Team and Team Experience **15 points**
- Qualifications and experience of Proposer Team, proposed key personnel, particularly project director and project manager, and subcontractors.
 - Quality and sufficiency of proposed staffing plan and organization structure.
- 5.3.3 Technical Approach; Implementation Schedule **30 points**
- Adequacy of Proposer’s approach to designing and constructing the Project, and understanding of the Project.
 - Proposed plan for the implementation and completion of the Project.
 - Project schedule.
 - Conceptual design plan.
- 5.3.4 Project Cost Proposal and Effectiveness **35 points**
- Basic Cost of Work for Design Services.
 - Basic Cost of Work for Construction.
 - Guaranteed Maximum Price.

TOTAL POSSIBLE POINTS: 100

ARTICLE 6
EXECUTION OF AGREEMENT AND COMPLETION OF WORK

- 6.1 The Design/Build Agreement will be prepared by the Town and provided to the selected Design/Builder. The Design/Builder shall, within 14 days of receipt of the Design/Build Agreement execute the Agreement and furnish any bonds and provide certificates of insurance as are required at the time of the execution of the Agreement.

The Town will enter into a negotiated Design/Build Agreement with the successful Proposer for a Guaranteed Maximum Price for the Work. The terms and conditions of the Design-Build Agreement are fixed price and fixed time. The Design/Builder's submitted Proposal is to be a guaranteed lump sum for completing the Work in this RFP. The Design/Builder will provide a Schedule of Values to the Town for their approval. The total of the Schedule of Values will be the lump-sum guaranteed price for the Work. The Design/Build will contain provisions common to design-build agreements for public improvements, including, but not limited to a design process with schematic, design development and construction drawing phases and 30/60/90% review of plans and specifications. The form of the Design/Build Agreement will be available to all proposers in advance of the Submission Deadline on the Town's website www.townofsurfsidefl.gov or via Addenda to this RFP.

- 6.2 Upon Town Commission approval, the Design/Builder shall, within fourteen (14) Days after receipt of Design/Build Agreement from the Town, 1) execute the Design/Build Agreement between Town and Design/Builder, 2) furnish any Bonds, and provide Certificates of Insurance required to be furnished at the time of execution of the Design/Build Agreement.
- 6.3 Should the Design/Builder fail to comply with the requirements of this Article within the specified time period, the Design/Builder's entire Proposal Security may be forfeited to the Town as liquidated damages by reason of Design/Builder's failure to timely execute and deliver same.
- 6.4 Work will be initiated on the basis of a Notice to Proceed and for any such Work so initiated, and a Payment Bond and Performance Bond shall be required.
- 6.5 The Proposer acknowledges the required security of a Proposal Bond or Cashier's Check.

ARTICLE 7
GENERAL INFORMATION AND ADMINISTRATIVE REQUIREMENTS

- 7.1 **Costs Incurred by Proposers:** All costs incurred by Proposers, their employees and agents, in preparing a response to this RFP, in clarifying such response to the satisfaction of the Town, in attending any pre-Proposal meetings, or in ascertaining the conditions of the site shall be the sole responsibility of the Proposers and will not be paid or reimbursed by the Town. The Proposer is further responsible for all legal expenses incurred by the Proposer for the Project, including contract review and negotiations. The Proposer's legal costs shall not be included in the Proposer's Proposal or factored into the Proposer's Project Cost Proposal. The Town shall not reimburse the Proposer for legal costs of any kind.
- 7.2 **Rejection of Proposals:** The Town reserves the right to reject any or all Proposals. Proposals not conforming to these instructions may be disqualified.
- 7.3 **Non-Binding Interpretations:** No verbal or written information, which is obtained other than by information in this RFP or written Addendum to this RFP, shall be binding on the Town.
- 7.4 **Withdrawal of Proposals:** A Proposal may not be withdrawn before the expiration of one hundred twenty (120) days from the date of Proposal opening. Proposals may be withdrawn if the Town fails to accept the Proposal within one hundred twenty (120) calendar days after the date fixed for opening Proposals.
- 7.5 **Public Records Laws:** Proposer acknowledges that except for specific statutory exceptions listed in Chapter 119, Florida Statutes, all information contained within their Proposal shall be considered a Public Record.
- 7.6 **Conflict of Interest:**
- 7.6.1 The award of this RFP is subject to the provisions of Chapter 112, Florida Statutes. All Proposers must disclose with their Proposal the name of any officer, director, or agent who is also an employee of the Town.
- 7.6.2 All Proposers must disclose the name of any Town employee, consultant or agent who owns, directly or indirectly, an interest of five percent (5%) or more of the Proposer's firm or any of its branches.

**ARTICLE 8
DESIGN CRITERIA PACKAGE**

- 8.1 **Design-Build Criteria:** The Town’s Design Criteria Professional prepared the Design Criteria Package for the design and construction of this Project. The purpose of the Design Criteria shall be to furnish design-build firms with sufficient information to allow the firms to prepare a response to the Town’s RFP. The design criteria includes, but is not limited to the following.
- 8.2 **Permitting:** Design/Builder shall, on behalf of the Town, apply for and obtain all permits, licenses and government approvals necessary for the design, construction and operations of the Project. All permit fees and associated costs for pursuing and obtaining required approvals and permits for the Work shall be the responsibility of the Proposer and shall be included in the Proposer’s Cost Proposal submitted in response to this RFP.
- 8.3 The Proposer’s approach to minimizing the impact of construction on the residential and commercial properties located within the Project area shall be described in detail.
- 8.4 Design and Construction Considerations and Requirements:
- 8.4.1 Proposer should be aware of all subsurface conditions.
- 8.4.2 The Town is subject to hurricanes and storms and therefore the Design/Builder shall consider such likelihood in their scheduling and construction activities.
- 8.4.3 It shall be the sole responsibility of the Design/Builder to secure any necessary temporary site or sites for use as staging areas for materials and equipment storage, temporary parking, and to accommodate any other logistical needs.
- 8.4.4 It shall be the Design/Builder’s sole responsibility to secure, store and dispose of all excess soil, drilling mud and any other construction spoils. The Town will not provide an area for storage or disposal of construction-related debris, nor will the Town provide labor or equipment to assist with such disposal.
- 8.4.5 **Special Concerns:** The special concerns included herein have been identified by the Town as particularly important to the citizens of Surfside. The special concerns include pedestrian traffic control, traffic mitigation, noise abatement, a minimal disruption to surrounding property owners and businesses. Proposers shall provide the Town with a plan and assurances to address all special concerns, including noise abatement.

EXHIBIT 1 – DESIGN CRITERIA PACKAGE

**LOCATION MAP OF COMMUNITY CENTER
(9301 Collins Avenue, Surfside, Florida 333154)**

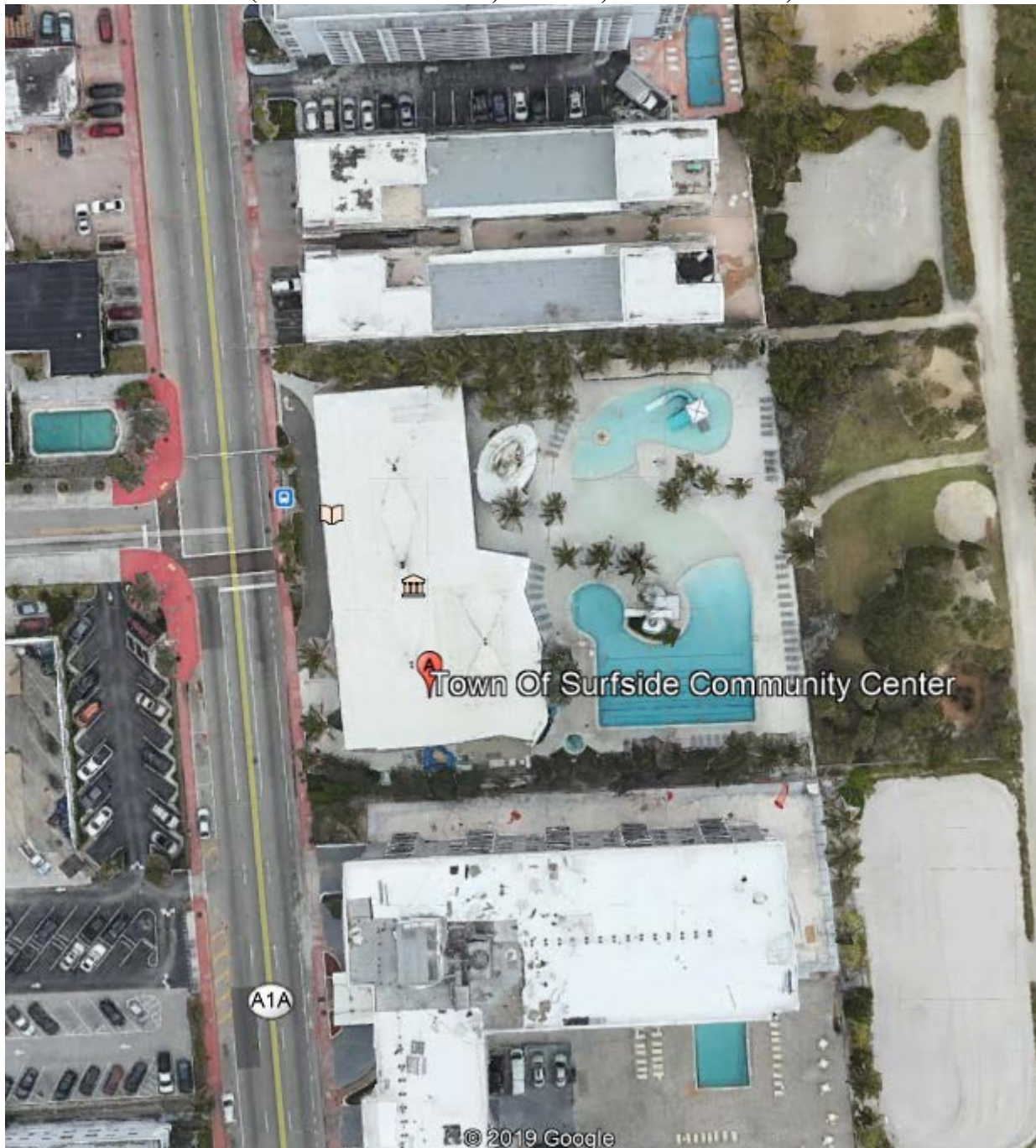

EXHIBIT 2 – DESIGN CRITERIA PACKAGE

**DESIGN CRITERIA PLANS
(EXHIBIT A THRU E)**

EXHIBIT 3 – RESENT FPL BILL

1 / 27 319870 8420052992931718874750000



FPL
GENERAL MAIL FACILITY
MIAMI FL 33188-0001

TOWN OF SURFSIDE
9293 HARDING AVE
SURFSIDE FL 33154-3000

Nov 27, 2019 Electric Bill

For: Oct 29, 2019 to Nov 27, 2019 (29 days)

Service Address
9301 COLLINS AVE
SURFSIDE, FL 33154
VAGRAMONTE@TOWNOFSURFSIDEFL.GOV
Account Number 05299-29317

Questions? Contact Us
Reliable energy is affordable energy.
Learn how we save you money at fpl.com/savings

TOWN OF SURFSIDE:
Here's what you owe for this billing period.

Amount of your last bill	\$3,198.70
New charges due by Dec 18, 2019	\$2,549.18
Total amount you owe	\$5,747.88

Amount of your last bill	3,198.70
Balance before new charges	\$3,198.70
NEW CHARGES	
Rate: GSD-1 GENERAL SERVICE DEMAND	
Customer charge:	\$26.32
Non-fuel: (\$0.023490 per kWh)	\$668.05
Fuel: (\$0.025630 per kWh)	\$728.92
Demand: (\$11.24 per KW)	\$932.92
Electric service amount	2,356.21
Storm charge	-13.94
Gross receipts tax	60.06
Franchise charge	146.85
Taxes and charges	192.97
Total new charges	\$2,549.18
Total amount you owe	\$5,747.88

Meter Summary

Meter reading - Meter KV58395 Next meter reading Dec 30, 2019
Current reading 26949
Previous reading -26712

kWh constant	x 120
kWh used	28440
Demand reading	.69
KW constant	x 120.00
Demand KW	83

Energy Usage Comparison

	This Month	Last Month	Last Year
Service to	Nov 27, 2019	Oct 29, 2019	Nov 29, 2018
kWh Used	28440	37560	31080
Service days	29	32	31
kWh/day	980	1173	1002
Amount	\$2,549.18	\$3,198.70	\$2,704.28

Energy Usage History

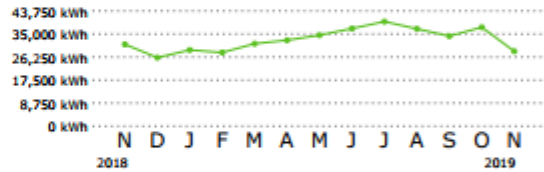

Keep In Mind

- Payment received after February 20, 2020 is considered LATE; a late payment charge of 1% will apply.
- The number of days included in your bill can vary month to month. So even if you use the same amount of energy per day, your bill may be higher next month due to greater number of service days. Visit www.FPL.com for more information.
- The Florida Public Service Commission approved a one-time refund related to the storm charge that is included in your November bill. Learn more: FPL.com/rates

Don't fall for a scammer

Scammers use caller ID spoofing appearing to be FPL. Don't fall for it when they demand payment with a prepaid card.
[Protect yourself](#)

Let's go solar, together

With FPL SolarTogether, a new proposed program, everyone has the opportunity to enjoy the benefits of solar.
[Learn More](#)

Useful Links
[Billing and service details](#)
[Energy News](#)
[View back of the bill](#)

Important Numbers

Customer Service: (305) 442-0388
Outside Florida: 1-800-226-3545
To report power outages: 1-800-4OUTAGE (468-8243)
Hearing/speech impaired: 711 (Relay Service)

**ARTICLE 9
PROPOSER'S ACKNOWLEDGEMENTS**

- 9.1 By submission of this Proposal, the Proposer acknowledges that he/she has thoroughly examined all plans, specifications, Proposal and Contract Documents; thoroughly familiarized himself with all existing site conditions; that no allowances shall be made by the Town for the Proposer's failure to do same; the Proposer offers to enter into a Design/Build Agreement with the Town to furnish Design/Services as well as all labor, materials and equipment to perform all Work included in and in accordance with the plans, Design Criteria Package, RFP and Contract Documents.
- 9.2 If the Proposer makes false statements or provides false information in any portion of the Proposal documents, the Proposer acknowledges that Proposer will be disqualified.
- 9.3 The Proposer understands and agrees with the form of this RFP as presented, absent any inadvertent drafting or technical errors, and agrees to not attempt to negotiate the terms and conditions of this Project, except as provided herein

**ARTICLE 10
REPRESENTATIONS**

- 10.1 Town is expressly relying upon the Proposer's representations for awarding this Project. Therefore, the Proposer unequivocally represents that the statements and information provided in response to this RFP are truthful.
- 10.2 The Proposer and all persons signing on behalf of the proposing person or entity, has the legal authority to bind the Proposer to the terms and conditions of this Project.
- 10.3 There are no legal impediments, conditions or orders, which would preclude the Proposer from satisfactorily performing the Proposer's duties as outlined in the RFP documents.

END OF INSTRUCTIONS

FORM “1”

PROPOSAL CHECKLIST

As provided in the RFP, the following items must be attached to this Proposal:

ITEMS	STATUS
Transmittal Letter	
TECHNICAL PROPOSAL	
Proposal Cover Sheet (Form 2)	
Proposer’s Statement of Qualifications (Form 5)	
Subcontractor Information (Form 5, Supplemental)	
Material/Equipment Suppliers Information (Form 5, Supplemental)	
References (Form 9)	
Statement on Public Entity Crimes (Form 6)	
Evidence of Insurability	
Project Organization and Management	
Staffing Plan	
Project Schedule	
Non-Collusion Affidavit (Form 7)	
Non-Discrimination Affidavit (Form 8)	
Project Cost Proposal (separate sealed package) (Form 3)	
Schedule of Values	
Proposal Security (Form 4)	

FORM "2"

PROPOSAL COVER SHEET

PROJECT: COMMUNITY CENTER PHOTOVOLTAIC SYSTEM

BID/PROJECT NO: RFP No. 2020-01

COMMENCEMENT: UPON TOWN'S ISSUANCE OF
"NOTICE TO PROCEED"

SUBSTANTIAL COMPLETION: _____ DAYS FROM "NOTICE TO PROCEED"

PROPOSAL BOND: _____

Made as of the _____ day of _____, 20____.

PROPOSER: _____

ADDRESS: _____

PHONE: _____

FAX: _____

ORGANIZATION
TYPE:

_____ INDIVIDUAL

_____ PARTNERSHIP

_____ CORPORATION

_____ OTHER (explain)

ACKNOWLEDGMENT OF ADDENDUM

The Proposer hereby acknowledges the receipt of the following addenda issued by the Town and/or Consultant and incorporated into and made part of the Design/Build Agreement and Contract Documents for this Project.

Addendum No. _____ **Date** _____

Addendum No. _____ **Date** _____

Addendum No. _____ **Date** _____

Addendum No. _____ **Date** _____

Addendum No. _____ **Date** _____

Addendum No. _____ **Date** _____

Addendum No. _____ **Date** _____

Addendum No. _____ **Date** _____

Addendum No. _____ **Date** _____

Addendum No. _____ **Date** _____

Signature **Title**

ACKNOWLEDGMENT AND SEAL

Firm Name

Signature

Title

Witness

Name

Witness

Name

Corporate Seal:

Incorporated under the laws of the State of _____ .

FORM "3"

**PROJECT COST PROPOSAL
(GUARANTEED MAXIMUM PRICE)**

Project Title: TOWN OF SURFSIDE - COMMUNITY CENTER PHOTOVOLTAIC SYSTEM

Payment for the various items of the Project Cost Proposal shall include all compensation for design and engineering services, construction, furnishing tools, equipment, supplies, and manufactured articles, labor operations, permit fees, licenses, taxes, insurances, bonds, overhead and profit, and incidentals appurtenances thereto, and including all costs of compliance with the regulations of public agencies having jurisdiction, including but not limited to the Occupational Safety and Health Administration of the US Department of Labor (OSHA), FDOT, Miami-Dade County and the Town. No separate payment will be made for any item that is not specifically set forth in the cost proposal, and all costs therefore shall be included in the prices provided below.

PROJECT COST PROPOSAL

		Lump Sum / Guaranteed Maximum Price
	Design cost: _____ Construction cost: _____	Total Project Cost Proposal: \$ _____ (Numerical) _____ Dollars (Written)

SUBMITTED BY

Organization

Signature

Signature of Witness

Name Title

Signature of Witness

Name Title

Date

END OF PROJECT COST PROPOSAL

FORM "4"

PROPOSAL SECURITY FORM

_____	_____
Name	Name
_____	_____
Address	Address

FLORIDA RESIDENT AGENT Name: Address: Telephone: Fax:	TOWN OF SURFSIDE 9293 HARDING AVENUE SURFSIDE, FLORIDA 33154 Telephone: 305-861-4863 Fax: 305-861-1302
--	---

PROJECT:	
_____	_____
Proposal Due Date	Bond Number
_____	\$ _____
Bond Date	Penal Sum

[ACKNOWLEDGMENTS ON FOLLOWING PAGE]

IN WITNESS WHEREOF, Surety and Proposer, intending to be legally bound hereby, subject to the terms included in this section, do each cause this Proposal Bond to be duly executed on its behalf by its authorized officer, agent, or representative.

PROPOSER

**SURETY
(Attach Power of Attorney)**

Corporate Name and Seal

Corporate Name and Seal

Signature

Signature

Name and Title

Name and Title

Attest

Attest

Attest

Attest

Note: Above addresses shall be used for giving of required notices. Any singular reference to Proposer, Surety, Florida Resident Agent, Town or other party shall be considered a plural where applicable.

1. Proposer and Surety, upon default of Proposer, jointly and severally, bind themselves, and their heirs, executors, administrators, successors and assigns to pay to Town upon default of Proposer the penal sum set forth on the face of this Bond.
2. Default of Proposer shall occur upon the failure of Proposer to deliver within the time required by the bidding documents (or any extension thereof granted in writing by Town) the executed Design Build Agreement and the Bonds and Certificates of Insurance required to be furnished at the time of execution of the Design Build Agreement.
3. This obligation shall be null and void if:
 - A. Town accepts Proposer’s Proposal and Proposer timely complies with the requirements of Section 2 of this Bond, or
 - B. All Proposals are rejected by Town , or
 - C. Town fails to issue a notice of award to Proposer within the time specified in the bidding documents (or any extension thereof granted in writing by Proposer and, if applicable, consented to be Surety when required by paragraph 5 hereof).

4. Payment under this Bond will be due and payable upon default by Proposer and within 30 calendar days after receipt by Proposer and Surety of written notice of default from Town, which notice will be given with reasonable promptness, identifying this Bond and the Project and including a statement of the amount due.
5. Surety waives notice of any and all defenses based on or arising out of any time extension to issue notice of award agreed to in writing by Town and Proposer, provided that the total time for issuing Notice of Award including extensions shall not in the aggregate exceed 120 days from bid due date without Surety's written consent.
6. No suit or action shall be commenced under this Bond prior to 30 calendar days after the notice of default required in paragraph 4 above is received by Proposer and Surety and in no case later than one (1) year after bid due date.
7. Any suit or action under this Bond shall be commenced only in a Monroe County, Florida court of competent jurisdiction. Any award granted shall not be subject to prejudgment interest.
8. Notices required hereunder shall be in writing and sent to Proposer and Surety at their respective addresses shown on the face of this Bond. Such notices may be sent by personal delivery, commercial courier or by United States Registered or Certified Mail, return receipt requested, postage pre-paid, and shall be deemed effective upon receipt by the party concerned.
9. Surety shall cause to be attached to this Bond a current and effective Power of Attorney evidencing the authority of the officer, agent or representative who executed this Bond on behalf of Surety to execute, seal and deliver such Bond and bind the Surety thereby.
10. This Bond is intended to conform to all applicable statutory requirements. Any applicable requirement of any applicable statute that has been omitted from this Bond shall be deemed to be included herein as if set forth at length. If any provision of this Bond conflicts with any applicable statute, then the provision of said statute shall govern and the remainder of this Bond that is not in conflict therewith shall continue in full force and effect.
11. The term "bid" as used herein includes a bid, offer or Proposal as applicable.

END OF PROPOSAL BOND

FORM "5"

STATEMENT OF PROPOSER'S QUALIFICATIONS

The Proposer, as well as any Subcontractors who will perform at least 20% of either the design or the construction phases of this Project, must be included in this Statement of Qualifications. Information provided on this document and its attachments will be subjectively evaluated by the Evaluation Committee. For purposes of completing this Statement of Qualifications, "Firm" means the Proposer. Design/Build Team means the Proposer and the Subcontractors who will perform at least 20% of either the design or the construction phases of this Project.

Use additional sheets if necessary to fully document responses.

1. List the names of the Proposer's principals and their titles:

Firm Name

Principal & Title

Principal & Title

Address

City, State & Zip Code

Phone

Fax

2. Proposer is a:
 Sole Proprietorship Corporation Partnership Joint Venture
 Other (Explain):

3. Your Federal Employer Identification Number (FEIN) is:

(If applicable) (If the entity has no FEIN, include the Social Security Number of the individual signing this sworn statement)

4. License(s) and Registration(s):

(a) What is the Proposer's primary practice or professional service:

Contractor Architect Engineer Other (explain):

(Attach copies of registrations, licenses, certificates, and other documentation as issued by the State of Florida, Miami-Dade County, or other agency.)

(b) List the name(s) and title(s) of person(s) in your Firm who are authorized to enter into an Design/Build Agreement with the Town of Surfside for the proposed Work should your Firm be the Successful Proposer.

Name & Title

Name & Title

(c) List Principals and other key personnel licensed in the State of Florida:

Name

Registration Type

Years Registered

Years Employed
by Proposer

Name

Registration Type

Years Registered	Years Employed by Proposer
------------------	-------------------------------

Name

Registration Type

Years Registered	Years Employed by Proposer
------------------	-------------------------------

(Attach copies of registrations, licenses, certificates, and other documentation as issued by the State of Florida, Miami-Dade County, or other agency.)

(d) Remarks:

5. How long has your Firm been in business under its present name?
_____.

6. Design/Build Team Composition:

(a) List Team Members (Attach additional sheets as necessary):

Team Member Name

Principal

Discipline/Specialty

Location

Team Member Name

Principal

Discipline/Specialty

Location

- (b) Attach copies of registrations, licenses, certificates, and other documentation as issued by the State of Florida, Miami-Dade County, or other agency.

7. Financial Statements for Proposer:

- (a) Attach audited financial statements for the last three years, or, at a minimum, CPA-reviewed financial statement for the last three years.
- (b) List annual revenues (last three years) and annual net income (Loss) (last three years)

8. Past Experience:

- (a) The Proposer must demonstrate their specific design and construction experience in the United States as presented by their Team, including but not limited to design and construction/installation of photovoltaic systems or similar systems.
- (b) **References:** Detailed description of comparable contracts as they pertain to the Scope of Services similar to that requested in this RFP, which the Proposer and Subcontractor has either ongoing or completed within the past five (5) years. The description should identify for each project: (i) client, (ii) a complete description of work, (iii) total dollar value of the contract, (iv) dates covering the term of the contract, (v) client contact person and phone number, (vi) statement of whether Proposer was the prime contractor or subcontractor, and (vii) the results of the project. Where possible, list and describe those projects performed for government clients or similar size private entities (excluding any work performed for the Town of Surfside).

- (c) Has the Proposer ever failed to complete a bonded obligation? If yes, provide details including circumstances, where and when, name of bonding company, name and address of owner, and disposition of matter on an attachment to this Form.
 Yes No

- (d) Has the Proposer ever been declared non-responsive or defaulted on a previous contract? If yes, provide details including circumstances, identification of the project, and disposition or current status of the matter on an attachment to this Form.
 Yes No

- (e) Within the last five years, has the Proposer been involved in a legal matter against the Town of Surfside? If yes, provide details including circumstances, identification of the project, and disposition or current status of the matter on an attachment to this Form.
 Yes No

- (f) Within the last five years, has the Proposer been involved in a matter that was arbitrated against the Town of Surfside? If yes, provide details including circumstances, identification of the project, and disposition or current status of the matter on an attachment to this Form.
 Yes No

9. Current Workload:

- (a) List current projects (either in design or under construction) including contract amounts, the scope of the project in square feet of construction, the current status or projected date of completion, and notation of whether participation in the project was fully bonded or not. Attach additional sheets as necessary to portray your total current workload.

Project
Value
Square Feet
Status
Bonded

Project

Value

Square Feet

Status

Bonded

9. Attachments:

(a) **MANDATORY ATTACHMENTS:**

1. Copy of professional registration and/or Certificates of Authorization issued by the Florida Department of Business and Professional Regulation indicating your Team’s qualifications as defined in Section 287.055, Florida Statutes.
2. Copies of professional licenses, registration, certifications, or certificates of competency issued by the Florida Department of Business and Professional Regulation or Miami-Dade County for the Proposer and Team Members.
3. Further Documentation or explanatory materials related to Items 6, 7 (g), 7 (h), and 8.
4. Visual examples of two (2) different projects representative of your Team’s work and comparable to the scope of services set forth in this RFP, such as photos of completed buildings or models, reproductions of renderings, plans, drawings or other types of information sufficient to indicate the quality and character of your work. Each submittal must not be larger than 8-1/2 by 11 inches and should include the following information:
 - a. The original estimated construction cost.
 - b. Time duration from the start of design to completion of construction documents.
 - c. Actual cost of construction awarded or completed.

(b) **OPTIONAL ATTACHMENTS:** Attach any brochures, photographs, video or other documentation that may assist in the evaluation of your Team. A complete copy of any optional

attachment must be included with each of the required copies of your Proposal to receive consideration.

The undersigned guarantees the authenticity of the foregoing statements and does hereby authorize and request any person, team, or corporation to furnish any information requested by the Town of Surfside in verification of the recitals comprising this Statement of Proposer's Qualifications.

(c) Proposer's Representations:

1. The Proposer acknowledges that the Town of Surfside is relying upon the Proposer's statements and representations for determining the Proposer's qualifications. Therefore, any misrepresentations, misstatements, or fraudulent statements shall be used, at the Town of Surfside's sole discretion, as a basis for disqualifying the Proposer.
2. The Proposer unequivocally represents that the statements and information provided in response to this qualification statement are truthful.
3. The Proposer and all persons signing on behalf of the bidding person or entity, has the legal authority to bind the Proposer or entity to the statements and representations made in this document.

SUBMITTED BY

Signature of Proposer

Printed Name

Title

Name of Firm

Date

Signature of Witness

Printed Name

Title

Name of Firm

Signature of Witness

Printed Name

Title

Name of Firm

FROM "6"

**TOWN OF SURFSIDE
Sworn Statement under Section 287.133(3)(a),
Florida Statutes on Public Entity Crimes**

(This form must be signed in the presence of a notary public or other officer authorized to administer oaths.)

1. This sworn statement is submitted with the RFP Contract for Design/Build of the Town of Surfside's Community Center Photovoltaic System.
2. This sworn statement is submitted by:

(Name of entity submitting sworn statement)

whose business address is:

Federal Employer Identification Number (FEIN) is: _____
(if the entity has no FEIN, include the Social Security Number of the individual signing this sworn statement)

(If applicable)

Social Security Number: _____

3. My name is: _____
(Print name of individual signing)

and my relationship to the entity is: _____

4. I understand that a "public entity crime" as defined in Section 287.133(1)(g), Florida Statutes means a violation of any state or federal law by a person with respect to and directly related to the transaction of business with any public entity or with an agency or political subdivision of any other state or with the United States, including, but not limited to, any bid or contract for goods or services to be provided to any public entity or an agency or political subdivision of any other state or of the United States and involving antitrust, fraud, theft, bribery, collusion, racketeering, conspiracy, or material misrepresentation.
5. I understand that a "convicted" or "conviction" as defined in Paragraph 287.133(1)(b), Florida Statutes means a finding of guilt of a conviction of a public entity crime, with or without an adjudication of guilt, in any federal or state trial court of record relating to charges brought by indictment or information after July 1, 1989, as a result of a jury verdict, non-jury trial, or entry of a plea of guilty or nolo contendere.

6. I understand that an “affiliate” as defined in Section 287.133(1)(a), Florida Statutes means:

- (a) A predecessor or successor of a person or a corporation convicted of a public entity crime; or
- (b) An entity under the control of any natural person who is active in the management of the entity and who has been convicted of a public entity crime. The term “affiliate” includes those officers, directors, executives, partners, shareholders, employees, members, and agents who are active in the management of an affiliate. The ownership by one person of shares constituting a controlling interest in another person, or a pooling of equipment or income among persons when not for fair market value under an arm’s length agreement, shall be a prima facie case that one person controls another person. A person who knowingly enters into a joint venture with a person who has been convicted of a public entity crime in Florida during the preceding 36 months shall be considered an affiliate.

7. I understand that a “person” as defined in Section 287.133(1)(e), Florida Statutes, means any natural person or entity organized under the laws of any state or of the United States with the legal power to enter into a binding contract and which bids or applies to bid on contracts for the provision of goods or services let by a public entity, or which otherwise transacts or applies to transact business with a public entity. The term “person” includes those officers, directors, executives, partners, shareholders, employees, members, and agents who are active in management of an entity.

8. Based on the information and belief, the statement which I have marked below is true in relation to the entity submitting this sworn statement. (Please indicate which statement applies)

_____ Neither the entity submitting the sworn statement, nor any officers, directors, executives, partners, shareholders, employees, members or agents who are active in management of the entity nor any affiliate of the entity have been charged with and convicted of a public entity crime subsequent to July 1, 1989.

_____ The entity submitting this sworn statement, or one or more of the officers, directors, executives, partners, shareholders, employees, members or agents who are active in management of the entity or an affiliate of the entity has been charged with and convicted of a public entity crime subsequent to July 1, 1989 and (Please indicate which additional statement applies)

_____ There has been a proceeding concerning the conviction before a hearing officer of the State of Florida, Division of Administrative Hearings. The final order entered by the hearing officer did not place the person or affiliate on the convicted vendor list. (Please attach a copy of the final order)

_____ The person or affiliate was placed on the convicted list. There has been a subsequent proceeding before a hearing officer of the State of Florida, Division of Administrative Hearings. The final order entered by the hearing officer determined that it was in the public interest to remove the person or affiliate from the convicted vendor list. (Please attach a copy of the final order)

_____ The person or affiliate has not been placed on the convicted vendor list. (Please describe any action taken by or pending with the Department of General Services.)

I UNDERSTAND THAT THE SUBMISSION OF THIS FORM TO THE CONTRACTING OFFICER FOR THE PUBLIC ENTITY IDENTIFIED IN PARAGRAPH 1 ABOVE IS FOR THAT PUBLIC ENTITY ONLY AND, THAT THIS FORM IS VALID THROUGH DECEMBER 31 OF THE CALENDAR YEAR IN WHICH IT IS FILED.

I ALSO UNDERSTAND THAT I AM REQUIRED TO INFORM THE PUBLIC ENTITY PRIOR TO ENTERING INTO A CONTRACT IN EXCESS OF THE THRESHOLD AMOUNT PROVIDED IN SECTION 287.017, FLORIDA STATUTES, FOR CATEGORY TWO OF ANY CHANGE IN THE INFORMATION CONTAINED IN THIS FORM.

Signature: _____
Name: _____
Title: _____

STATE OF FLORIDA)
) ss:
COUNTY OF _____)

Sworn to and subscribed and acknowledged before me this ____ day of _____, 2020, by _____, as _____ (title) of _____ (Proposer/Company name), and on behalf of the corporation and who is personally known to me or has produced _____ as identification and who did take an oath.

[SEAL]

Notary Public, State of Florida

Print Name of Notary

Commission No. _____

Commission Expires: _____

FORM "7"

NON-COLLUSION AFFIDAVIT

The undersigned Bidder/Proposer has not divulged discussed or compared his/her Bid Proposal with any other Bidders/Proposers and has not colluded with any other Bidder/Proposer or parties to this Bid/Proposal whatsoever.

Signature

Name

Title

Date

Witness my hand and official notary seal/stamp at _____ the day and year written above.

STATE OF FLORIDA)
) ss:
COUNTY OF _____)

Sworn to and subscribed before me this ____ day of _____, 20____,

by _____ who (check one) [] is personally known to me or [] has produced as identification.

Notary Public, State of Florida

Print or Type Name of Notary Public

My commission expires:
(Seal)

END OF NON-COLLUSION AFFIDAVIT

FORM "9"
REFERENCES

The following is a list of at least three (3) references from municipalities for which Proposer provided similar services or comparable contracts to those sought in this RFP in the past five (5) years:

Name of Entity for which services were performed: _____
Brief Description of Scope of Services: _____
Amount of Contract Award: _____
Status of Contract: _____
Contact Name: _____
Telephone Number: _____

Name of Entity for which services were performed: _____
Brief Description of Scope of Services: _____
Amount of Contract Award: _____
Status of Contract: _____
Contact Name: _____
Telephone Number: _____

Name of Entity for which services were performed: _____
Brief Description of Scope of Services: _____
Amount of Contract Award: _____
Status of Contract: _____
Contact Name: _____
Telephone Number: _____

Name of Entity for which services were performed: _____
Brief Description of Scope of Services: _____
Amount of Contract Award: _____
Status of Contract: _____
Contact Name: _____
Telephone Number: _____

Name of Entity for which services were performed: _____
Brief Description of Scope of Services: _____
Amount of Contract Award: _____
Status of Contract: _____
Contact Name: _____
Telephone Number: _____



MEMORANDUM

ITEM NO. 9MM

To: Honorable Mayor, Vice-Mayor and Members of the Town Commission
From: Guillermo Olmedillo, Town Manager
Date: 05/12/2020
Subject: Beachwalk Trimming

Background: The Town Commission directed staff to confirm that there are permits in place and to get quotes in order to trim the sea grapes along the Beachwalk.

Analysis Staff has contacted the Florida Department of Environmental Protection (FDEP) regarding permits. FDEP advised that no permit is required for the trimming of the sea grapes as long as some maintenance requirements are met. Three vendors have been contacted to receive quotes to trim the sea grapes along the Beachwalk.

Budget Impact: Unknown at this moment

Commission direction: Staff will bring back this item during the next Commission meeting with the different quotes in order for the Town Commission to decide.

Reviewed by

Prepared by



MEMORANDUM

ITEM NO. 9NN

To: Honorable Mayor, Vice-Mayor and Members of the Town Commission
From: Guillermo Olmedillo, Town Manager
Date: May 12, 2020
Subject: Community Center Pool Deck Lighting

The Parks and Recreation Department is looking into an engineering firm to assist in the feasibility and basic design criteria to install permanent pool deck lighting. This would include all Florida Building Code (FBC) and Town of Surfside Code of Ordinances covering turtle protection. Also, included in this would be the Florida Department of Environmental Protection (DEP) and Florida Fish and Wildlife Commission (FWC) guidelines.

The cost would include the preparation of an RFP, all permits required for the project and to oversee the construction and closeout of the project. Operational cost will also be included to cover additional staff, projected utilities and pool chemicals on an annual basis.

Per the request of the Town Commission, staff will have these costs available during the budget process for Fiscal Year 2021.

Reviewed by: TM

Prepared by: TM



MEMORANDUM

ITEM NO. 900

To: Honorable Mayor, Vice-Mayor and Members of the Town Commission
From: Guillermo Olmedillo, Town Manager
Date: May 12, 2020
Subject: Community Center Second Floor

The Town of Surfside Community Center was designed and constructed under the provisions of the Florida Building Code 3rd Edition (2007) including consideration for a second story according to the approved structural plans specifically sheet S3.0.02. An elevator pit and section of the roof structure not continuous or poured separately from the rest of the roof slab. This portion of the slab that was pinned in place to be removed at some future time to accommodate an elevator shaft. These two elements were left in the design and constructed accordingly to allow said future second story. This area is now known as "Fish Bowl". No other elements have been found on the approved plans or records. Nothing in the design and construction of the Community Center precludes a second story from being designed and built at some future date. Note the present code in-force is the Florida Building Code 6th Edition (2017). Aforementioned details taken from sheet S3.0.02 of the approved plans below.

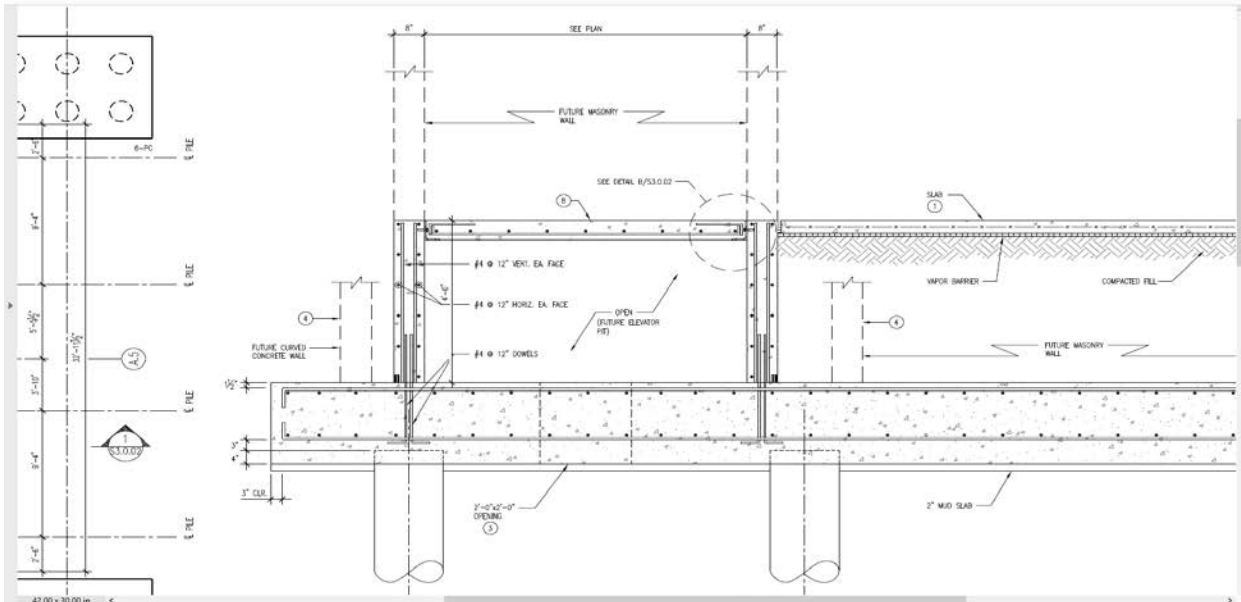

Reviewed by: MR/RP

Prepared by: MR/RP

ORDINANCE NO. 17 - 11062

AN ORDINANCE OF THE TOWN COMMISSION OF THE TOWN OF SURFSIDE, FLORIDA AMENDING CHAPTER 86 "WATERWAYS"; ARTICLE II, "PUBLIC BEACHES", SPECIFICALLY AMENDING SECTION 86-26 "DEFINITIONS"; SPECIFICALLY AMENDING SECTION 86-31 "BEACH FURNITURE PERMIT REQUIREMENTS"; SPECIFICALLY AMENDING SECTION 86-33 "VIOLATIONS, CIVIL FINES AND PENALTIES"; PROVIDING FOR INCLUSION IN THE CODE; REPEALING ALL ORDINANCES OR PARTS OF ORDINANCES IN CONFLICT HEREWITH; AND PROVIDING FOR AN EFFECTIVE DATE.

WHEREAS, the Town has the authority to promulgate laws to regulate the public beach in a reasonable manner to protect public health, safety, and welfare, which must have a rational relation and be reasonably designed to accomplish a purpose necessary for the protection of the public; and

WHEREAS, the Florida Constitution states that "The title to lands under navigable waters, within the boundaries of the state, which have not been alienated, including beaches below mean high water lines, is held by the state, by virtue of its sovereignty, in trust for all the people," s.11, Art. X, Fla. Const; and

WHEREAS, on December 13, 2016 the Town Commission adopted Ordinance No. 16-1658 to regulate beach furniture and its corresponding *Administrative Policy: Beach Furniture and Equipment* which provides for public access and safety and requirements for beach furniture; and

WHEREAS, on April 13, 2017 the Town Commission directed Town Administration to amend the beach furniture ordinance to clarify terms in the ordinance; and

WHEREAS, the Town Commission held its first public hearing on May 9, 2017 and recommended approval of the proposed amendments to the Code of Ordinances having complied with the notice requirements by the Florida Statutes; and

WHEREAS, the Town Commission has conducted a second duly noticed public hearing on these regulations as required by law on June 13, 2017 and further finds the proposed change to the Code necessary and in the best interest of the community.

NOW, THEREFORE, BE IT ORDAINED BY THE TOWN COMMISSION OF THE TOWN OF SURFSIDE, FLORIDA:

Section 1. Recitals. The foregoing "WHEREAS" clauses are ratified and confirmed as being true and correct and are made a specific part of this Ordinance.

Section 2. Code Amendment. Article II, "Public Beaches," specifically Section 86-26 "Definitions," Section 86-31 "Beach Furniture Permit Requirements" and Section 86-33 "Violations, Civil Fines and Penalties" is hereby amended as follows:

Sec. 86-26. - Definitions.

* * *

Beach Furniture Operator is ~~a hotel located on the east side of Collins Avenue which uses or allows another party to use such beach furniture as part of a short term paid lodging authorized through a Certificate of Use issued by the Town.~~ a hotel or Condominium Association located on the east side of Collins Avenue that provides beach furniture services to its residents and guests or a hotel located on the west side of Collins Avenue so approved by the Town Commission pursuant to Section 86-31(B)(2) of the Town Code.

Beach Furniture Setup is the organized preplacement of beach furniture by a Beach Furniture Operator in anticipation of use by an individual Beach Furniture User.

Beach Furniture Storage is the overnight placement of beach furniture on the public beach.

Beach Furniture User is an individual using any item of beach furniture while on the public beach. This applies to the general public, condominium residents and hotel guests.

* * *

Sec. 86-31. - Beach Furniture Permit Requirements.

Beach Furniture Operator, as defined in this article must obtain a permit for Beach Furniture Setup and Beach Furniture Storage ~~to place beach furniture~~ on the public beach within the Town. Town Manager or designee shall establish an Administrative Policy: Beach Furniture and Equipment for the placement of beach furniture on the public beach ~~by Beach Furniture Operators for public safety, access and maintenance, as set forth by Administrative Policy.~~ A hotel Beach Furniture Operators must procure a local business tax receipt and comply with the regulations of Section 70-41 of the Town of Surfside Code and all required licenses or permits from Miami-Dade County, the State of Florida and federal entities.

Sections ~~86-26 86-31~~ to 86-33 herein shall be reviewed by the Town Commission within one year of after its enactment and the Town will notify any Beach Furniture Permit holder prior to any meeting of such review. Nothing in Sections 86-31 to 86-33 shall require a permit from the general public to place beach chairs and/or equipment on the beach for personal use on an as needed basis.

~~A.~~ Application. Any Beach Furniture Operator shall apply for a Beach Furniture pPermit on a form prepared by the Town along with the applicable permit application fee. All permit applications shall include the following:

- (1) An application fee of \$500.00;

- ~~(2) An evacuation plan, in the event of a natural disaster such as a tropical storm or hurricane, including a storage area.~~
- ~~(3) Beach furniture operations plan, including specifications on storage, staffing and clean-up.~~
- ~~(4) Compliance with indemnification and insurance requirements pursuant to Section 86-32 of the Town of Surfside Code.~~

A. Beach Furniture Permit applications for hotels or Condominium Association located on the east side of Collins Avenue shall include the following:

- (1) An application fee of \$500.00;
- (2) Beach Furniture Operations Plan, including specifications on setup, storage, staffing and clean-up, and an evacuation plan, in the event of a natural disaster such as a tropical storm or hurricane, specifying a storage area during the natural disaster.
- (3) Compliance with indemnification and insurance requirements pursuant to Section 86-32 of the Town of Surfside Code.

B. Beach Furniture Permit applications for hotels located on the west side of Collins Avenue must be approved by the Town Commission.

- (1) Beach Furniture Permit applications for hotels located on the west side of Collins Avenue shall include the following:
 - a. An application fee of \$500.00;
 - b. Beach Furniture Operations Plan, including specifications on storage, staffing and clean-up, and an evacuation plan, in the event of a natural disaster such as a tropical storm or hurricane, including a storage area;
 - c. Compliance with indemnification and insurance requirements pursuant to Section 86-32 of the Town of Surfside Code;
- (2) All applications for hotels located on the west side of Collins Avenue are subject to the Town Administrative Policy: Beach Furniture and Equipment and shall be approved by the Town Commission.
 - a. The Town Commission shall review each application for conformity with the Town Administrative Policy: Beach Furniture and Equipment and decide whether the application shall be approved, approved with conditions, or denied.
 - b. The Town Commission Public Hearing shall be advertised at least once in a local newspaper of general circulation or publicly posted in the Town Hall at least ten days prior to the Public Hearing. Written courtesy notices shall be sent by first class mail to affected property owners within a radius of 300 feet and shall contain a copy of the Beach Furniture Permit application.

A notice, 18 inches by 24 inches, shall be placed in a prominent place on the property by the applicant at the applicant's own expense denoting the following:

REQUEST FOR: _____

TOWN COMMISSION MEETING: DATE AND TIME

TOWN HALL
9293 Harding Avenue
Surfside, FL 33154

COMPLETE INFORMATION REGARDING THE BEACH FURNITURE PERMIT APPLICATION IS AVAILABLE BY CONTACTING THE TOWN HALL.

- B. C. Exemption. Nothing in this article shall require a permit from a member of the general public to place beach furniture on the public beach for personal use.
- C. D. Review of Beach Furniture Permit application. A permit shall be granted upon the submittal of a completed application and the required fee, unless the Town Manager or designee or the Town Commission for Beach Furniture Permit applications pursuant to Section 86-31(B)(2) of the Town Code, determines that the granting of such a permit:

- (1) Unduly impedes governmental business or public access;
- (2) Conflicts with previously scheduled activities;
- (3) Imperils public safety; or
- (4) Violates any public policy or local, state or federal law.

- D. E. A ~~Beach Furniture Permit~~ is revocable if the applicant does not meet the requirements as specified in the Town Code, Administrative Policy: Beach Furniture and Equipment and applicant's operation plan. A hotel Beach Furniture Operator is subject to the provisions of Article II "Local Business Tax Receipt" of Chapter 70 of the Town Code.

- E. F. Appeals. If a Beach Furniture Permit is denied or revoked by the Town Manager or designee, the Beach Furniture Operator may, within 30 days of the decision, file a notice of appeal to the Town Commission. The appeal shall be heard as a quasi-judicial matter.

Sec. 86-33. - Violations, Civil fines and penalties.

Any person or entity found to be in violation of any condition of this section ~~the permit~~ issued herein shall first be issued a warning. Failure to correct the violation within one hour following the issuance of a warning shall result in the issuance of a Civil Violation Notice ~~to the Beach Furniture Operator. The notice shall be as provided pursuant to in~~ Section 15-10 of the Town Code. ~~Failure to correct the violation may result in revocation of the permit. Failure to obtain the required permit shall subject the owner to a fine of \$500 per day.~~

Violations of this section shall be subject to the following fines.

- a. If the violation is the first violation-\$100.00
- b. If the violation is the second violation within the preceding 12 months-\$500.00

c. Any subsequent violation after the second violation within the preceding 12 months-\$1,000.00

d. After the third violation, a Beach Furniture Operator shall be suspended from Beach Furniture operations for a period of one year from the date of violation.

Section 4. Severability. If any section, subsection, clause or provision of this Ordinance is declared invalid or unconstitutional by a court of competent jurisdiction, the remainder shall not be affected by such invalidity.

Section 5. Conflict. All sections or parts of sections of the Town of Surfside Code of Ordinances in conflict herewith are intended to be repealed to the extent of such conflict.

Section 6. Inclusion in the Code of Ordinances. It is the intention of the Town Commission, and it is hereby ordained that the provisions of this Ordinance shall become and made a part of the Town of Surfside Code of Ordinances, that the sections of this Ordinance may be renumbered or relettered to accomplish such intentions; and the word "Ordinance" may be changed to "Section" or other appropriate word.

Section 7. Effective Date. This Ordinance shall be effective upon final adoption on second reading.

PASSED and ADOPTED on first reading this 9 day of May, 2017.

PASSED and ADOPTED on second reading this 13 day of June, 2017.

On Final Reading Moved by: Commissioner Gielchinsky
On Final Reading Second by: Commissioner Karukin

FINAL VOTE ON ADOPTION

Commissioner Daniel Gielchinsky

Commissioner Michael Karukin

Commissioner Tina Paul

Vice Mayor Barry Cohen

Mayor Daniel Dietch

yes
yes
Absent
no
yes



Daniel Dietch, Mayor

ATTEST:



Sandra Novoa, MMC, Town Clerk

**APPROVED AS TO FORM AND LEGALITY FOR THE USE
AND BENEFIT OF THE TOWN OF SURFSIDE ONLY:**

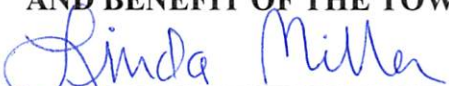

Linda Miller, Town Attorney

Administrative Policy

June 13, 2017.

BEACH FURNITURE AND EQUIPMENT

It is the purpose of this Administrative Policy to further the intent of the adopted Town Ordinance regulating the use of beach furniture within the corporate limits of the Town of Surfside.

A permit issued by the Town is required before a Beach Furniture Operator, as defined in the Ordinance, may place furniture on the beach.

The following are the guidelines for placement of furniture on the beach:

1. Beach furniture may not be placed directly behind of or in front of a lifeguard tower or within 10 feet of the entire perimeter of the lifeguard tower, or obstruct a lifeguard's or emergency personnel's view of the beach or ocean.
2. No Beach Furniture Operator shall place beach furniture in the area immediately adjacent to or directly seaward of the street ends throughout the Town of Surfside.
3. All beach furniture shall be set at no less than 12 feet seaward of the edge of the vegetation line of the dune.
4. Beach Furniture Operator that is a hotel shall submit an operations plan to be reviewed by the Town Manager which includes specifications on set up, number of chairs to be preset (not to exceed 40) and stored, removal procedures, hours, storage, staffing and clean-up.
5. Beach Furniture Operator that is a Condominium Association shall submit an operations plan to be reviewed by the Town Manager which includes specifications on set up, number of chairs to be preset (not to exceed 10% of the number of dwelling units of the Condominium) and stored, removal procedures, hours, storage, staffing and clean-up.
6. Beach furniture shall not be set out in the morning before sunrise, or before completion of daily monitoring for turtle nesting activity by a Florida Fish and Wildlife Conservation Commission authorized marine turtle permit holder to examine the beach in the area of the authorized activity to ensure any new sea turtle nests are identified and marked, whichever occurs first.

7. The Beach Furniture Operator shall be responsible for ensuring that the beach furniture is clearly identified as to its ownership, maintained in good condition, free from evidence of deterioration, weathering, and discoloration, at all times. Beach furniture shall be approved by the Town Manager and such approval shall not be unreasonably withheld.
8. Beach furniture shall be deployed in a manner to assure public access and to encourage public use of the beach and shall cause no obstruction to the general public.
9. A Beach Furniture Operator may store beach furniture on their property or east of the dune neatly organized and secured to the ground.
10. Any request from a Code Enforcement Officer, or lifeguard to relocate beach furniture shall be complied with immediately.
11. In the event of a declared state of emergency, the Town Manager or designee may issue a warning to the Beach Furniture Operator to remove and secure the beach furniture. If the Beach Furniture Operator fails to remove the beach furniture, the Town Manager or designee, at its option, may remove the beach furniture from the public beach. The Beach Furniture Operator shall be liable for all costs incurred by the Town for the removal and storage of the beach furniture in the event of an emergency.

Beach Furniture Operators (11) and
Their Pre-Set Limits
(as of October 1, 2019)

Azure Condos 8

Carlisle on the Ocean Condo 12

Grand Beach Hotel 35

Fendi Chateau Ocean Condo 6

Four Seasons Hotel 31

Marriott Residence Inn No Pre-set allowed / 40 chairs
maximum for all days and at all times.

Solara Surfside Resort 6

Solimar Condos 21

Spiaggia Condos 10

Surfside Towers Condo 13

The Waverly Condo Association 11



MEMORANDUM

ITEM NO. 9QQ

To: Honorable Mayor, Vice-Mayor and Members of the Town Commission
From: Guillermo Olmedillo, Town Manager
Date: May 26, 2020
Subject: Designated (Painted) Walking Areas in the Residential District

At the April 16th, 2020 Special Commission Meeting, Town Administration was directed to provide a plan to create designated (painted) pedestrian areas in the single-family residential district. The Town Administration reviewed implemented plans in nearby municipalities to determine available options and related costs.

Due to width limitations of residential roadways and the shared purpose of roadways for vehicular circulation, parking, pedestrian and non-motorized vehicles, the Town Commission should consider creating only one designated (painted) walking areas along the roads. In addition, the Town Commission should also give direction indicating the streets to be considered. The minimum allowed sidewalk width for the American Disability Act (ADA) purposes is 36-inches. For purposes of the designated (painted) walking area, a 5-foot width is considered for use which is a typical residential concrete sidewalk width.

A typical Town block within the residential area is approximately 240-feet wide from west to east and 635-feet long from north to south. For purposes of pricing, a typical unit block will be considered as 875-feet which includes the combination of 240-feet wide from west to east and 635-feet long from north to south. For example, a typical block with proposed designated (painted) walking area can be Carlyle Avenue from 90th Street to 91st Street (northern) and Carlyle Avenue to Dickens Avenue along 91st street (eastern).

Picture A – “Typical Unit Block” below outlines a visual representation of a typical unit block and proposed pathway along one side of street and avenue.



Picture A – “Typical Unit Block”

The Town reviewed previous projects by City of Miami Beach, Bay Harbor Islands and obtained private market pricing from vendors in order to determine a unit cost per typical block. As a result, **Table A – “Cost Options”** below was composed in order to provide cost options for various designated walking areas in the residential district:

Option Number	Description of Option	Cost per Linear Feet	Total Cost per Typical Unit Block
1	White Line Shared Lane	\$2.50	\$2,187.50
2	Green Cover Shared Lane	\$45.00	\$39,375.00

Table A – “Cost Options”

Attachment A – “Visual Representations” provides a visual representation of each option as installed in actual locations and provides further description of each option.

The Town Administration seeks direction about the streets to be designated so that a total plan can be prepared with cost, procurement recommendation and time of execution.

Reviewed by: GO

Prepared by: HG



P I A W I S A A

White shared lane samples were installed as part of a previous project within the Town of Surfside. In installed samples, the white shared lanes are of pavement paint material. The cost option is priced as thermoplastic marking which creates a reflection during night time and has a longer duration life.



P I G S A A

This option is typical of bicycle and shared use lanes. Shared use lanes are depicted by two arrows above bicycle icon. The option can be encountered along Byron Ave between 85th Street to 87th Street within the City of Miami Beach. The material is a proprietary material only applied by a limited amount of contractors. The bicycle icon can be removed or changed to a pedestrian similar to Option A.

LAST REVISION 05/19/2020	DESCRIPTION: OPTIONS FOR SHARED LANES	 TOWN OF SURFSIDE	PAINTED LANES OPTIONS SCALE: N.T.S. SHEET 1 of 1
-----------------------------	--	--	--

To: Honorable Mayor, Vice-Mayor and Members of the Town Commission
From: Guillermo Olmedillo, Town Manager
Date: April 14, 2020
Subject: Comparison of 2006 code to 2020 code

The attached tables describe the differences between the 2006 code and the 2020 code per zoning district. The most significant changes from the 2006 code are summarized below:

1. Single family district requires additional setbacks for second story and limits the square footage of a second story based on the percentage of the first story.
2. Single family homes have a 10-foot base flood elevation requirement versus 8 feet in 2006 in keeping with FEMA requirements.
3. Single family lot coverage (what can be seen under roof from above) currently has certain exclusions, such as patios. Previously, anything under roof qualified as lot coverage.
4. Multifamily properties on the east side of Harding Avenue can have a length up to 90 feet if there is a 17-foot gap in the façade. Previously, the requirement was a maximum of 50 feet with the option to go up to 100 feet with a 25-foot recess.
5. Multifamily properties on the west side of Collins Avenue can have a length up to 250 feet if there is a 17-foot gap in the façade versus 150 feet, however hotels are limited to 150 feet in length.
6. Significant landscape requirements for multifamily and hotel uses were added.
7. Height is limited by the Charter and has not been changed in any district. It should be noted that the increase in base flood elevation means that the first habitable floor is higher now than prior to 2006. However, height is measured from the crown of the road to the top of the building and therefore the increase in base flood elevation has not increased overall height.
8. Minimum window openings, design features and wall plane elevation changes were added to all zoning districts.

Single family waterfront lots		RS-1 (2006 Code)	H30A (2020 Code)
PAGE 640 Height	Principal Building	30 ft	30 ft
	Accessory	12 ft	12 ft
Height	Stories	2	2
	Base Flood Elevation	8 ft	10 ft
Lot	Lot Width (Min)	50 ft	50 ft
	Lot area / dwelling (Min)	8,000 sq ft	8,000 sq ft
	Lot Coverage (Max)	40%	40%
	Minimum FI Area (Min)	2,500 sq ft	No minimum, changed to a maximum square footage for 2 nd floors
	Primary	20 ft	20 ft
	Interior side	5 ft	5 ft
Setbacks (Min)	Interior side for lots over 50 ft in width	10% of frontage	10% of the frontage
	Second floor interior side setbacks	No additional setbacks required	An average of 5 – 10 additional feet depending on the size of the 2 nd story, not to exceed 80% of the first
	Rear	20 ft	20 ft
	Secondary (corner only)	10 ft	10 ft
Pervious Area (Min)		50% of front yard and 40% of rear yard to be landscaped.	35% minimum pervious area for total lot. 50% of front yard and 20% of rear yard to be landscaped.

Single family interior lots		RS-2 (2006 Code)	H30B (2020 Code)
Height	Principal Building	30 ft	30 ft
	Accessory	12 ft	12 ft
Height	Stories	2	2
	Base Flood Elevation	8 ft	10 ft
Lot	Lot Width (Min)	50 ft	50 ft
	Lot area / dwelling (Min)	5,600 sq ft	5,600 sq ft
	Lot Coverage (Max)	40%	40%
	Minimum FI Area (Min)	1,800 sq ft	No minimum, changed to a maximum square footage for 2 nd floors
	Primary	20 ft	20 ft
	Interior side	5 ft	5 ft
Setbacks (Min)	Interior side for lots over 50 ft in width	10% of frontage	10% of the frontage
	Second floor interior side setbacks	No additional setbacks required	An average of 5 – 10 additional feet depending on the size of the 2 nd story, not to exceed 80% of the first
	Rear	20 ft	20 ft
	Secondary (corner only)	10 ft	10 ft
Pervious Area (Min)		50% of front yard and 40% of rear yard to be landscaped.	35% minimum pervious area for total lot. 50% of front yard and 20% of rear yard to be landscaped.

		RD-1 (2006 Code)			H30C (2020 Code)
Determination	Single family	Two-family	Multi-Family	Zoning District	
PAGE 671 Height (Max)	Principal Building	30 ft	30 ft	30 ft	
	Accessory	12 ft	12 ft	12 ft	
	Stories	2	2	2	
Lot	Lot Width (Min)	50 ft	75 ft	50 ft	
	Lot area / dwelling (Min)	5,000 sq ft	2,500 sq ft	2,000 sq ft	
	Lot Coverage (Max)	Not Specified	Not Specified	Not Specified	
Setbacks (Min)	Minimum FI Area (Min)	1,800 sq ft	950 Sq ft	Based on use	
	Primary	20 ft	20 ft	20 ft	
	Interior side	5 ft	5 ft	6 ft minimum or 10% of the total interior frontage up to 15 ft, whichever is greater	
Maximum frontage	Interior side for lots over 50 ft in width	10% of frontage	10% of frontage	6 ft minimum or 10% of the total interior frontage up to 15 ft, whichever is greater	
	Rear	20 ft	20 ft	10 ft	
	Secondary (corner only)	10 ft, 15 ft on east west lots	10 ft, 15 ft on east west lots	10 ft, 15 ft on east west lots	
Pervious Area (Min)		100 feet with 25 foot recesses or 50 feet without recesses	100 feet with 25 foot recesses or 50 feet without recesses	90 feet subject to 3 conditions; and equivalency	
		50% of the front setback, 40% of rear setback	50% of the front setback, 40% of rear setback	20%	

		RM-1 (Old Code)		H40 (2020 Code)	
	Determination	Multi Family	Hotel & Motel	Width is ≤ 50 ft	Width is > 50 ft
Height (Max)	Principal Bldg	40 ft	40 ft	40 ft	40 ft
	Accessory	Not Specified	Not Specified	12 ft	12 ft
	Stories	3	3	1 and 2 family = 2 MF and Hotel = 3	1 and 2 family = 2 MF and Hotel = 3
Lot	Lot Width (Min)	75 ft	100 ft	50 ft	50 ft
	Lot area / dwelling (Min)	750 Sq ft	400 Sq ft	Not Specified	Not Specified
	Lot Coverage (Max)	Not Specified	Not Specified	Not Specified	Not Specified
	Minimum FI Area (Min)	Based on use	Based on Use	Not Specified	Not Specified
Setbacks (Min)	Primary*	20ft	20 ft	20 ft; 25 ft for portions above 30 feet; except historic bldgs.	20 ft; 25 ft for portions above 30 feet; except historic bldgs.
	Interior side	7 ft	7 ft	6 ft minimum or 10% of the total interior frontage up to 15 ft, whichever is greater	7 ft minimum or 10% of the total interior frontage up to 15 ft, whichever is greater
	Interior side for lots over 50 ft in width	10% of frontage	10% of frontage	6 ft minimum or 10% of the total interior frontage up to 15 ft, whichever is greater	7 ft minimum or 10% of the total interior frontage up to 15 ft, whichever is greater
	Rear	10ft	20 ft	10 ft	10 ft
Maximum frontage	Secondary (corner only)	10ft	10 ft	10 ft	10 ft
		150ft with 25 foot recesses or 75 feet without recesses	150ft with 25 foot recesses or 75 feet without recesses	150 ft for hotels, 150 ft, or up to 250 ft with equivalent gaps of 17 ft in width for multi-family	150 ft for hotels, 150 ft, or up to 250 ft with equivalent gaps of 17 ft in width for multi-family
Pervious Area (Min)		50% of the front setback, 40% of rear setback	50% of the front setback, 40% of rear setback	50% of the front setback plus 20% of overall site	50% of the front setback plus 20% of overall site

*2006 code identified the "primary" front setback on a corner lot as the shorter of the two streets. This was modified in the current code to add that if the parcel is on Collins or Harding, that frontage becomes the primary front setback, regardless if the Collins or Harding portion of the lot is shorter. This to provide greater setbacks on Collins and Harding.

		RT-1 (2006 Code)		H120 (2020 Code)	
<u>Determination</u>		<u>Multi-Family</u>	<u>Hotel and Motel</u>	<u>Zoning District</u>	
Height (Max)	Principal Building	120 ft	120 ft	120 ft	
	Accessory	Not Specified	Not Specified	12 ft	
Lot	Stories	12	12	12	
	Lot Width (Min)	100 ft	150 ft	50 ft	
	Lot area / dwelling (Min)	400 Sq ft	Not Specified	Not Specified	
	Lot Coverage (Max)	Not Specified	Not Specified	Not Specified	
	Minimum FI Area (Min)	Based on use	Based on use	Based on use	
Setbacks (Min)	Primary	40 ft	40 ft	40 ft	
	Interior side	10 ft, additional side setbacks when the building exceeds 30 feet in height.	10 ft, additional side setbacks when the building exceeds 30 feet in height.	10% of the frontage, no less than 10 feet, additional side setbacks when the building exceeds 30 feet in height.	
	Rear	30 ft	30 ft	30 ft	
	Secondary (corner only)	20 ft	20 ft	10% of the lot frontage, no less than 20 feet	
Maximum frontage	150 ft	150 ft	150 ft		
Pervious Area (Min)	50% of the front setback	50% of the front setback	20%		



MEMORANDUM

ITEM NO. 9VV

To: Honorable Mayor, Vice-Mayor and Members of the Town Commission
From: Guillermo Olmedillo, Town Manager
Date: June 23, 2020
Subject: Stormwater Master Plan

At the April 28th, 2020 Special Commission Meeting, Town Administration was directed to report back to the Commission regarding the Town's statutory requirement for a Stormwater Master Plan. The following information relates to the requirements and uses for Stormwater Master Plan.

- If a municipality operates a stormwater utility (such as the Town does), a stormwater management program is required by FS 403.0891, which includes stormwater master plan for planning and improvement purposes per Rule 62-40.431(3)(d), Florida Administrative Rules. The County requires that National Pollution Discharge Elimination System (NPDES) regulations and best management practices are followed for water quality, which is a stormwater management program, not a stormwater master plan.
- The difference – A Stormwater Master Plan is a planning tool; the management program is a compliance tool.
 - The Stormwater Master Plan considers and models existing flooding areas (often identified by staff and residents) and future conditions (such as sea level rise) in order to:
 - Develop solutions to improve the flooding level of services (LOS)
 - Establish Future goals and regulations.
 - Recommend a capital improvement program that is both technically sound and financially supportable.
 - Provide a foundation for future policy decisions.
 - Incorporate and update the stormwater management plan in order to comply with state and federal National Pollutant Discharge Elimination System (NPDES) regulations.
- Most local governments have a Stormwater Master Plan and update it every 5-10 years to keep it current since it establishes the Capital Improvement Program (CIP) and helps stay in compliance with NPDES requirements.

The Town did commission the completion of portions of the plan (ICPR model) in 2008 as part of the infrastructure rehabilitation project but did not commission the completion of a complete Stormwater Master Plan.

To address the Commissions inquiries regarding costs of the plan, we have compiled the data on Stormwater Master Plan costs from other jurisdictions. These plans were publicly bid and not completed by CGA; they were completed by other engineering firms.

	SqMiles	Price	Year	Years ago	Avg CPI increase	Adjusted CPI Price	\$/SQ Mi
Port Ft Pierce	0.04	\$ 188,663.00	2018	2	2.50%	\$198,214.06	\$5,663,258.98
Bal Harbour Village	0.38	\$ 136,675.00	2014	6	2.50%	\$158,501.10	\$417,108.15
Golden Beach	0.32	\$ 168,800.00	2000	20	2.50%	\$276,598.46	\$864,370.17
Surfside	0.56	\$ 175,980.00	2020	0	2.50%	\$175,980.00	\$314,250.00
Key Biscayne	1.25	\$ 293,000.00	2011	9	2.50%	\$365,916.85	\$292,733.48

Reviewed by: JG/LA

Prepared by: CG



City of Miami Beach, 1700 Convention Center Drive, Miami Beach, Florida 33139, www.miamibeachfl.gov

Item 13.
COMMITTEE MEMORANDUM

TO: Land Use and Sustainability Committee

FROM: Jimmy L. Morales, City Manager

DATE: May 6, 2020

TITLE: **DISCUSSION: ESTABLISHMENT OF PENALTIES FOR PROPERTY OWNERS ENGAGING IN DEMOLITION BY NEGLECT**

ACTION REQUESTED:

Conclude the item and recommend that the City Commission adopt the attached ordinance.

ADMINISTRATION RECOMMENDATION:

Discuss the item and recommend that the City Commission adopt the attached ordinance.

HISTORY:

On July 17, 2019, at the request of Commissioner Ricky Arriola, the City Commission referred the discussion item to the Land Use and Development Committee (Item C4 O). The item was discussed at the September 18, 2019 LUDC meeting, and continued to the October 30, 2019 meeting with the following direction:

1. The administration and City Attorney's office will research and provide recommendations regarding a process for imposing proportional fines, development and use reductions, and building registrations.
2. The administration will bring a discussion item to the October 8, 2019 meeting of the Historic Preservation Board for recommendations on posting unsafe structures on the city's website.

On October 30, 2019, the item was discussed and continued to the December 2, 2019 LUDC, with the following direction:

1. The administration and the City Attorney will further evaluate the recommendations noted in the LUDC memo regarding proportional fines and building registry, as well as creating a process for as-built drawings of contributing structures.
2. Recommend that the City Commission refer the proposed amendment to chapter 118, article X, pertaining to a presumption clause, to the Planning Board.
3. The addresses of properties that have both an active unsafe structures violation and have been referred to the Miami-Dade County Unsafe Structures Board by the Building Official will be posted on the City website. This list shall be posted within the Building Department webpage, and the Planning Department webpage shall contain a direct link.

The December 2, 2019 LUDC meeting was cancelled, and the item was moved to the January 21, 2020 agenda of the newly created Land Use and Sustainability Committee. On January 21, 2020 the item was continued to the February 18, 2020 LUSC meeting. On February 18, 2020 the item was continued to March 17, 2020. The March 17, 2020 was cancelled and the item was moved to the May 6, 2020 LUSC agenda.

ANALYSIS:

PLANNING AND LEGAL ANALYSIS

On October 8, 2019, the Historic Preservation Board discussed the matter and recommended that the City begin the process of posting the addresses of properties that have an active unsafe structures violation and have been referred to the Miami-Dade County Unsafe Structures Board by the Building Official on the City website. The Board also recommended that this information be available on either the Building Department or Planning Department page.

As indicated on October 30, 2019, planning staff and the City Attorney's office have researched and discussed other options to address demolition by neglect in historic districts. The following is an update and summary of these efforts:

1. Fines. The way properties are currently fined is general and not specific to the size of the building. The administration and the City Attorney's office have researched the concept of proportional fines and it appears that it is not pre-empted under State law. The administration and the City Attorney are exploring potential amendments that would result in more proportional fines for larger buildings.
2. Building Registry. The Building Department is researching and evaluating a method to establish a building registry process.

UPDATE

The ordinance pertaining to the presumption clause, as previously recommended by the Land Use and Development Committee, is pending before the City Commission and scheduled to be adopted on May 13, 2020. Additionally, a list of unsafe buildings has been posted on the City website, with a direct link from the planning department webpage.

About as-built drawings, as indicated previously, there are a couple of different options; each, however, has a budget impact and would need to be part of a budget enhancement for FY 2021. These include hiring an architectural firm or local University to do built drawings based upon available archival plans and a field assessment. Another potential option would be laser scanning and point cloud files that are then rendered. In those instances where a contributing building is proposed to be replaced or substantially modified, the Architect of record already puts together a detailed set of as-built drawings. Given the current limited need for such drawings on an emergency basis, as well as the potential cost of computer software required, the administration recommends that such a process not move forward at this time.

The administration has reviewed a model building registry ordinance from the City of Riviera Beach, as well as an updated list of abandoned commercial properties, which is color coded based on priority. Also included in the list of properties is the number of stories and the square footage to assist with determining appropriate, proportional fees. The attached draft ordinance, which amends chapter 58 of the City Code, and creates a building registry process specific to Miami Beach. The following is a summary of the key points of the proposed ordinance:

- Terms specific to the proposed Abandoned and Vacant Properties Registry have been defined.
- Division 4 has been created within chapter 58, establishing an Abandoned and Vacant Properties Registry.
- Applicability: All properties within a locally designated historic district are subject to the Abandoned and Vacant Properties Registry. A property must register within 15 days of becoming abandoned or vacant.
- Detailed registration requirements have been developed. This includes a nonrefundable annual registration fee in the amount of two hundred dollars (\$200) per property, as well as a nonrefundable annual fee of thirty cents (\$0.30) per square foot shall be paid for any building or structure that exceed three (3) stories. This tiered approach to assessing fees will have a greater impact on larger structures, which are typically more vulnerable to demolition by neglect.
- A responsibility for compliance section is established, requiring that is the responsibility of the owner to maintain the property in accordance with the provisions in this article.

The administration believes that the proposal herein will create a fair and transparent process for tracking at risk properties within the City's local historic district. Additionally, it will allow for the City to proactively monitor the conditions of the structures, and better enforce the demolition by neglect section of the City Code.

The one section of the legislation that still needs to be worked out is the administering City department for the registry. The administration is discussing this internally, and it is anticipated that this piece of the legislation will be ready for first reading.

Applicable Area

Citywide

Is this a "Residents Right to Know" item, pursuant to City Code Section 2-14?

Yes

Does this item utilize G.O. Bond Funds?

No

Departments

Planning

ATTACHMENTS:

Description	Type
□ Draft ORD - Building Registry	Memo

Evelyn Herbello

From: Eliana R. Salzhauer
Sent: Wednesday, July 01, 2020 3:30 PM
To: Sandra McCready
Cc: Lily Arango; Evelyn Herbello; Guillermo Olmedillo
Subject: INFORMATION FOR DISTRIBUTION ASAP: Potential Ballot Question - P3/Lease or Sale of Town Property

Hi Sandra-

Please circulate this note & memo written by Lili to our Mayor & Commissioners.

It is her response to my request for information regarding protecting Surfside from future potential P3 exploitation with a ballot question.

This is an area that I think we all consider a high priority for our residents.

Closing the loopholes in our current Town Code & Charter can be discussed at tonight's Zoning Workshop. This is an opportunity to protect Surfside for future generations.

Thank you-
Eliana

From: Lillian M. Arango <larango@wsh-law.com>
Sent: Monday, June 29, 2020 4:02 PM
To: Eliana R. Salzhauer <esalzhauer@townofsurfsidefl.gov>
Subject: Potential Ballot Question - P3/Lease or Sale of Town Property

Hi Eliana:

I researched this issue and this is what I found. Section 4 of the Town Charter currently permits the unrestricted sale or lease of Town property or lands, and I see no restrictions in the Town Code either. Section 4 of the Charter provides:

- **Sec. 4. - General powers of town; powers not deemed exclusive.**
- The town shall have all the powers granted to municipal corporations and to towns by the constitution and general laws of the state, together with all the implied powers necessary to carry into execution all the powers granted. **The town may acquire property within or without its corporate limits for any town purpose, in fee simple or any lesser interest or estate, by purchase, gift, devise or lease, and may sell, lease, mortgage, hold, manage and control such property as its interests may require.** Except as prohibited by the constitution of this state or restricted in this Charter, the town shall and may exercise all municipal powers, functions, rights, privileges and immunities of every name and nature whatsoever.

In our opinion, Charter 4 of the Charter should be amended if the Commission wants to place any permanent restrictions or limitations on the sale or lease of Town land. Please note that Commission direction is required as to the components of the restrictions and limitations. Many cities have similar provisions, but there are different ways to accomplish this and impose limitations and restrictions: for example, there could a term/length limit on

the leasing of land, or a value threshold for the sale of land, and exceptions for certain interests in land, such as easements. Typically, this would be a matter that would be studied and other jurisdictions researched for a provision that would best suit Surfside. Some cities would activate a committee to study the issue and report back to the Commission.

Section 97.1 of the Charter (follows section 6.03 of the County Charter) and provides that an item may be placed on the ballot with the adoption of a *Resolution* by the Commission. The Resolution could call for a straw non-binding referendum or a binding ballot question. For example, a non-binding straw ballot question could read: "Should Section 4 of the Charter be amended to include a limitation on the sale or lease of Town lands or property to require" A binding ballot question would contain the actual language amending section 4 of the Charter with specificity as to the restrictions.

In sum, this important item (and the specifics as to the restrictions to be imposed) should require Commission discussion and direction, as well staff and potentially committee analysis. It would be imprudent for me to draft the restrictions without Commission direction and careful analysis. For all of the foregoing reasons, I would recommend that this item first go to the Commission for discussion and direction and the item be carefully studied as to the proper restrictions for Surfside.

Please feel free to call me to discuss further. Thanks

LILLIAN
ARANGO
PARTNER



2525 Ponce de Leon Blvd., Suite 700 | Coral Gables, FL 33134

P: (305) 854-0800 E: larango@wsh-law.com Bio | wsh-law.com | [vCards](#)



THINK BEFORE YOU PRINT

This message, together with any attachments, is intended only for the addressee. It may contain information which is legally privileged, confidential and exempt from disclosure. If you are not the intended recipient, you are hereby notified that any disclosure, copying, distribution, use, or any action or reliance on this communication is strictly prohibited. If you have received this e-mail in error, please notify the sender immediately by telephone or by return e-mail and delete the message, along with any attachments.

Pursuant to the Fair Debt Collection Practices Act, this communication is from a debt collector. Any information obtained will be used for the purpose of collecting a debt.

ORDINANCE NO. 20 - _____

AN ORDINANCE OF THE TOWN COMMISSION OF THE TOWN OF SURFSIDE, FLORIDA AMENDING THE TOWN OF SURFSIDE CODE OF ORDINANCES BY AMENDING SECTION 90-2 "DEFINITIONS" TO AMMEND THE DEFINITION OF LOT COVERAGE TO PERMIT AMEND EXCEPTIONS TO LOT COVERAGE REQUIREMENTS; PROVIDING FOR SEVERABILITY; PROVIDING FOR INCLUSION IN THE CODE; PROVIDING FOR CONFLICTS; AND PROVIDING FOR AN EFFECTIVE DATE.

WHEREAS, Article VIII, Section 2 of the Florida Constitution, and Chapter 166, Florida Statutes, provide municipalities the authority to exercise any power for municipal purposes, except where prohibited by law, and to adopt ordinances in furtherance of such authority; and

WHEREAS, the Town Commission of the Town of Surfside ("Town Commission") finds it periodically necessary to amend its Code of Ordinances and Land Development Code ("Code") in order to update regulations and procedures for maintain consistency with state law and to implement municipal goals and objectives; and

WHEREAS, at its regular Commission meeting on _____, the Town Commission directed staff to evaluate and prepare an ordinance amending the Town's Code to _____; and

WHEREAS, the Town Commission wishes to amend Section 90-2, of the Town Code to amend the permitted exceptions to lot coverage regulations; and

WHEREAS, the Planning and Zoning Board, as the local planning agency for the Town, held its hearing on the proposed amendment on _____ with due public notice and input; and

WHEREAS, the Town Commission held its first public hearing on _____ 2020, and recommended approval of the proposed amendments to the Code of Ordinances having complied with the notice requirements of the Florida Statutes; and

WHEREAS, the Town Commission has conducted a second duly noticed public hearing on these regulations as required by law on _____, 2020 and further finds the proposed changes to the Code necessary and in the best interest of the community.

NOW, THEREFORE, BE IT ORDAINED BY THE TOWN COMMISSION OF THE TOWN OF SURFSIDE, FLORIDA¹:

34 **Section 1. Recitals.** The above Recitals are true and correct and are incorporated herein
35 by this reference:

36 **Section 2. Town Code Amended.** Section 90-2 “Definitions” of the Surfside Town Code
37 of Ordinances is hereby amended and shall read as follows¹:

38
39 **Sec. 90-2. - Definitions.**

40 * * *

41 *Lot coverage:* The percentage of the total area of a lot that, when viewed from above, would be
42 covered by all principal and accessory buildings and structures, or portions thereof; provided
43 however that ~~allowable exclusions, as described under "floor area,"~~ the following shall not be
44 included in determining the building area:

- 45 (1) Uncovered steps and exterior balconies up to a maximum of [redacted] square feet;
46 (2) Uncovered terraces, patios, breezeways, or porches which are open on two (2) sides;
47 and
48 (3) Covered terraces, patios, breezeways, or porches which are open on two (2) sides up
49 to a maximum of [redacted] square feet.

50 In no event may exempt area exceed [redacted] % of lot size.

51 * * *

52 **Section 5. Severability.** If any section, sentence, clause or phrase of this ordinance is
53 held to be invalid or unconstitutional by any court of competent jurisdiction, then said holding
54 shall in no way affect the validity of the remaining portions of this ordinance.

55 **Section 6. Inclusion in the Code.** It is the intention of the Town Commission, and it is
56 hereby ordained that the provisions of this Ordinance shall become and made a part of the Town of
57 Surfside Code of Ordinances, that the sections of this Ordinance may be renumbered or re-lettered
58 to accomplish such intentions; and the word “Ordinance” may be changed to “Section” or other
59 appropriate word.

60
61 **Section 7. Conflicts.** Any and all Ordinances and Resolutions or parts of Ordinances or
62 Resolutions in conflict herewith are hereby repealed.

63
Coding: ~~Strikethrough words~~ are deletions to the existing words. Underlined words are additions to the existing words. Changes between first and second reading are indicated with highlighted double strikethrough and double underline.

64 **Section 8. Effective Date.** This ordinance shall become effective upon adoption.

65

66 **PASSED** and **ADOPTED** on first reading this ___ day of _____, 2020.

67

68 **PASSED** and **ADOPTED** on second reading this _____ day of _____, 2020.

69

70

71 On Final Reading Moved by: _____

72

73 On Final Reading Second by: _____

74

75

76 **FINAL VOTE ON ADOPTION:**

77 Commissioner Nelly Velasquez _____

78 Commissioner Eliana R. Salzhauer _____

79 Commissioner Charles Kesl _____

80 Vice Mayor Tina Paul _____

81 Mayor Charles W. Burkett _____

82

83

84 _____

85 Charles W. Burkett, Mayor

86

87

88

89 **ATTEST:**

90

91 _____

92 Sandra Novoa, MMC, Town Clerk

93

Coding: ~~Strikethrough words~~ are deletions to the existing words. Underlined words are additions to the existing words. Changes between first and second reading are indicated with highlighted double strikethrough and double underline.

94 **APPROVED AS TO FORM AND LEGALITY FOR THE USE**
95 **AND BENEFIT OF THE TOWN OF SURFSIDE ONLY:**

96

97 _____

98 Weiss Serota Helfman Cole and Bierman, P.L.

99 Town Attorney

DRAFT

Coding: ~~Strikethrough words~~ are deletions to the existing words. Underlined words are additions to the existing words. Changes between first and second reading are indicated with highlighted ~~double strikethrough~~ and double underline.